



# Solidly Mounted Resonator 3D

## Introduction

A solidly mounted resonator (SMR) is a piezoelectric MEMS resonator formed on top of an acoustic mirror stack deposited on a thick substrate. This tutorial shows how to simulate an SMR in 3D. In this example, the eigenmodes were computed with varying number of particles attached to the sensor surface for computing the sensitivity, and the corresponding change in frequency response was analyzed. The resonant frequency decreases with more attached particles, and the sensitivity depends on the attachment location relative to the mode shape — both observations are as expected.

## Model Definition

The 2D geometry of the SMR model and its key components are shown in [Figure 1](#).

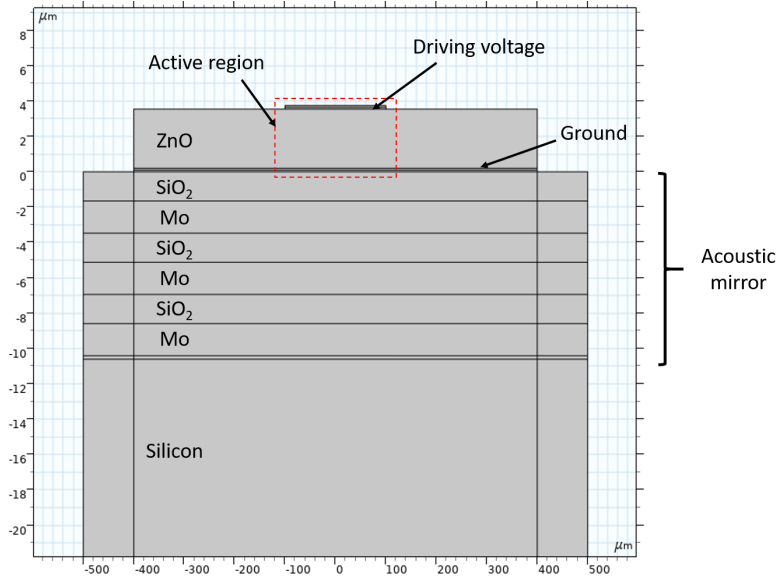
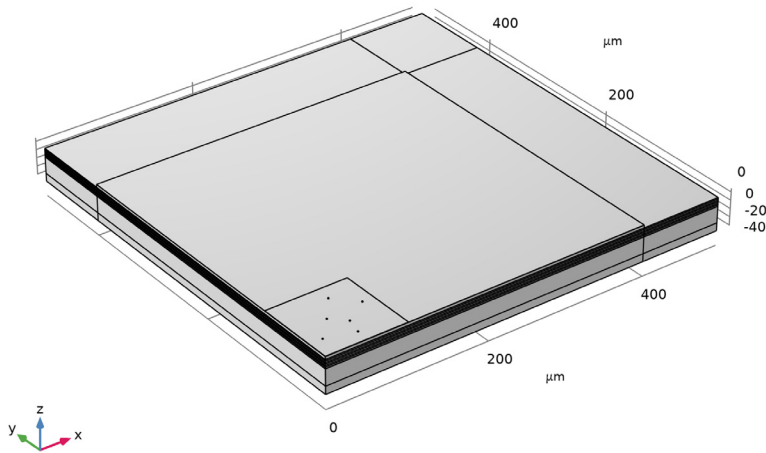

*Figure 1: 2D model geometry showing the key components of the solidly mounted resonator.*

Note that for clarity, the vertical scale is magnified to show the layers.

In the 3D model, to save computation resources, symmetry planes are used to reduce the modeling domain to 1/4 of the full device as shown in [Figure 2](#). All dimensions are

parameterized in the model. Various selection features are used for the construction of the geometry and the setup of physics and mesh.



*Figure 2: Model geometry.*

The fabrication of the device is discussed in [Ref. 1](#). Here we provide a description of the final structure and an explanation of its principle of operation.

At the top of the device is a ZnO piezoelectric layer with aluminum electrodes at its top (drive) and bottom (ground) surfaces. Here, the pole direction is along the vertical axis and the piezoelectric material data is available in the built-in MEMS material library.

Underneath the piezoelectric resonator is a stack of alternating layers of molybdenum (high impedance) and silicon dioxide (low impedance). The thickness of the molybdenum and silicon dioxide layers were chosen to be  $1.82 \mu\text{m}$  and  $1.65 \mu\text{m}$ , respectively, to reflect the acoustic wave generated by the piezoelectric resonator and to prevent its dissipation in the silicon substrate. With this structure, the resonant frequency of the device is 870 MHz.

The parameters of the geometry are summarized in the first table in the section [Modeling Instructions](#). The second table in the same section summarizes the material properties used in the model as specified in [Ref. 1](#). Other material properties used in the model are obtained from the MEMS Module material library. As shown in the table, the Young's moduli of the materials and the wavelength in silicon are computed from the values of density and acoustic velocity listed in the paper.

In this model, the fully coupled structural and electrostatic equations are solved in the piezoelectric layer, while only the structural equation is solved in other layers. Electrostatics equations are not solved in the aluminum layers because of its high electrical conductivity.

Perfectly Matching Layers (PML) boundary conditions are used at the sides and the bottom of the device to introduce anchor damping and eliminate reflections. The model also includes mechanical losses through an isotropic structural loss factor of  $1.5 \times 10^{-4}$ . The model has fixed boundary conditions at the outer edges of the PML.

In addition to the device structure, six cubes of 1  $\mu\text{m}$  size are added to the geometry to represent particles attached to the active area of the sensor (Figure 3). The global parameters  $p1 \sim p6$  are used to switch on/off the particles by scaling the material density.

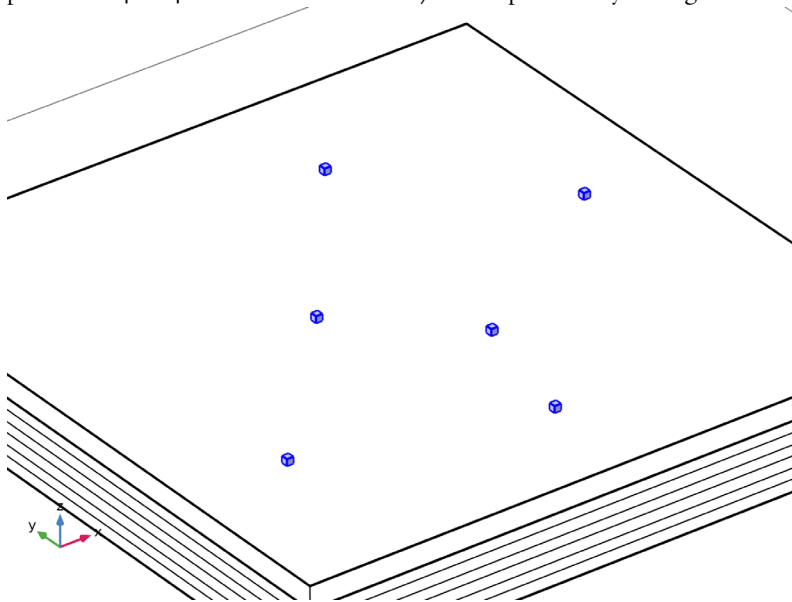

*Figure 3: Six cubes of 1  $\mu\text{m}$  size to model attached particles.*

The effect of the particles are investigated using Eigenfrequency and Frequency Domain studies.

To save time and reduce file size, a relatively coarse mesh is used, in particular in the horizontal direction. Thus only the main lower modes will be resolved in this model. The same approach was taken in the reference paper.

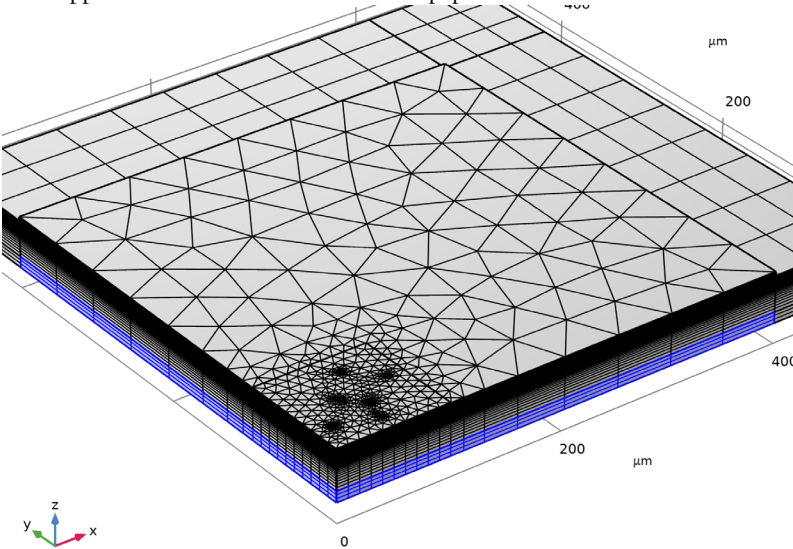

Figure 4: The mesh used in the model.

## Results and Discussion

Figure 5 shows the mode shape of the fundamental mode of the resonator with the resonant frequency of about 870 MHz as intended by the design described in Ref. 1.

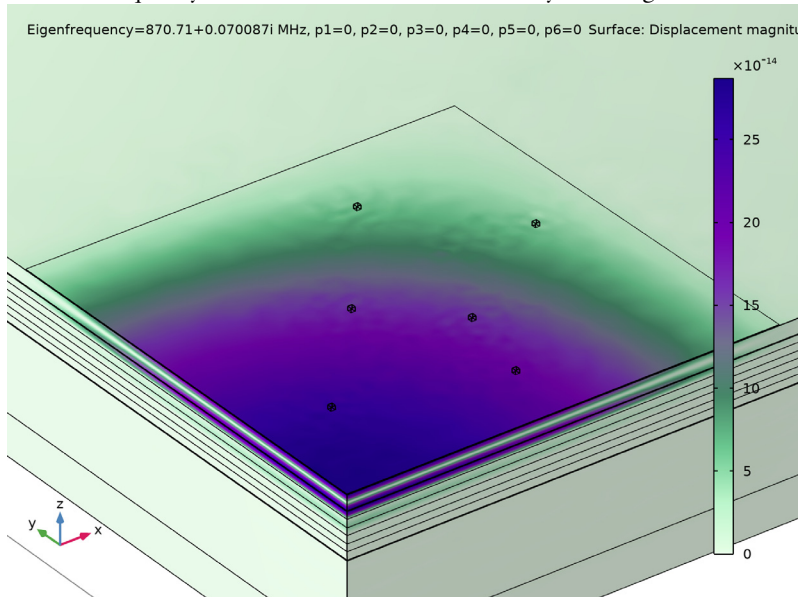

Figure 5: Mode shape of the resonator's fundamental mode.

In the next two figures, the same mode shape is plotted with two particles attached to the sensor surface. It will be seen that both the mode shape variation and the frequency shift depend on the location of the particles.

Figure 6 shows the mode shape with two particles attached at the periphery of the sensor. The frequency shift is small and the mode shape does not change much.

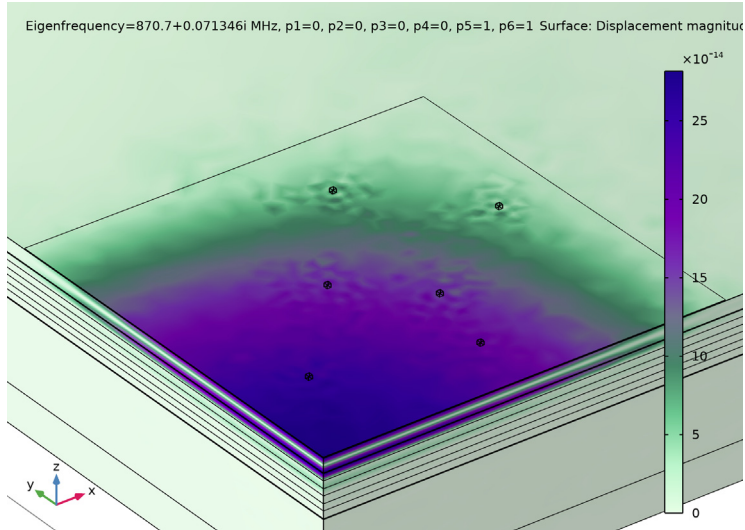

Figure 6: Mode shape with two particles attached at the periphery.

Figure 7 shows the mode shape with two particles attached close to the center of the sensor. The frequency shift is large and the mode shape is perturbed significantly.

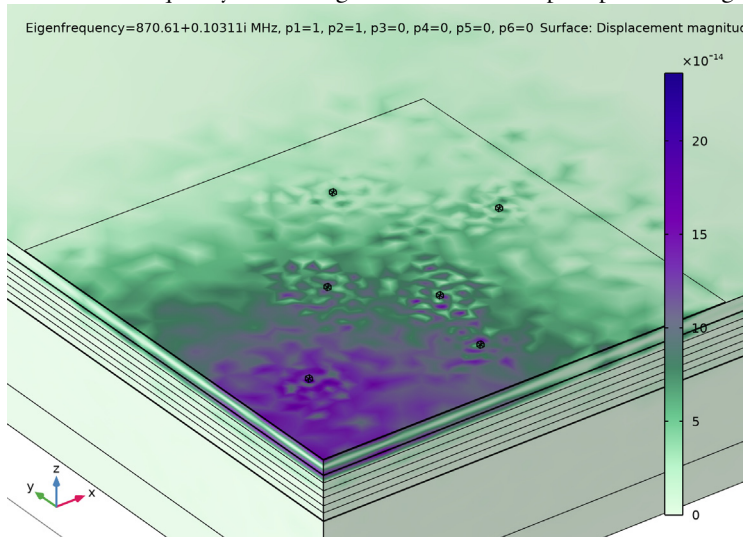

Figure 7: Mode shape with two particles attached close to the center.

The fact that the response of the sensor to attached particles depends on the particle locations is further illustrated in the plot of resonant frequency versus total particle mass below. The scatter of the data points demonstrates the dependence on the particle locations. The sensitivity is estimated to be about 10 MHz/ng from the graph.

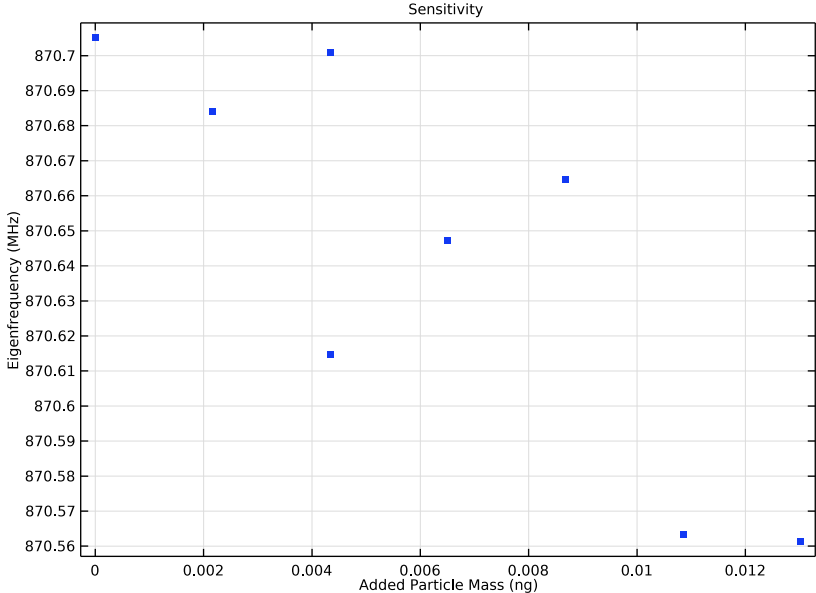

Figure 8: Resonant frequency versus total particle mass.



Figure 9 plots the electric potential at resonance from the frequency domain study.

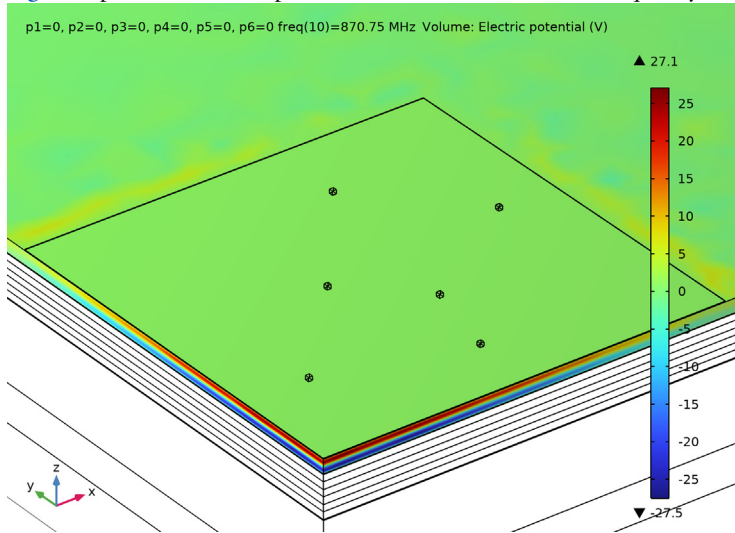

Figure 9: Electric potential at resonance.

Figure 10 shows the expected trend of lower resonant frequency with attached particles.

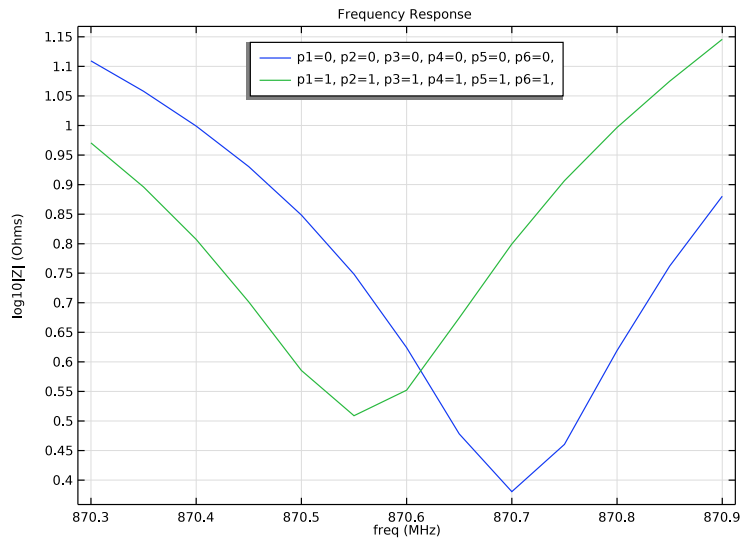

Figure 10: Frequency response with versus without attached particles.

## Reference

---

1. F.H. Villa-López and others, “Design and Modelling of Solidly Mounted Resonators for Low-Cost Particle Sensing,” *Measurement Science and Technology*, vol. 27, no. 2, 2016.

---

**Application Library path:** MEMS\_Module/Piezoelectric\_Devices/  
solidly\_mounted\_resonator\_3d

---

## Modeling Instructions

---



Start with a new 3D model with the built-in piezoelectric physics.

From the **File** menu, choose **New**.

### NEW

In the **New** window, click  **Model Wizard**.

### MODEL WIZARD

- 1 In the **Model Wizard** window, click  **3D**.
- 2 In the **Select Physics** tree, select **Structural Mechanics>Electromagnetics-Structure Interaction>Piezoelectricity>Piezoelectricity, Solid**.
- 3 Click **Add**.
- 4 Click  **Study**.
- 5 In the **Select Study** tree, select **Preset Studies for Selected Multiphysics>Eigenfrequency**.
- 6 Click  **Done**.

### GEOMETRY I

Set the geometry unit to microns for convenience.

- 1 In the **Model Builder** window, under **Component 1 (comp1)** click **Geometry 1**.
- 2 In the **Settings** window for **Geometry**, locate the **Units** section.
- 3 From the **Length unit** list, choose **µm**.

Enter geometry parameters. Note that we will truncate most of the thickness of the Si substrate and replace it with a perfectly matched layer (PML).

## GLOBAL DEFINITIONS

### Parameters 1 - Geometry

- 1 In the **Model Builder** window, under **Global Definitions** click **Parameters 1**.
- 2 In the **Settings** window for **Parameters**, type Parameters 1 - Geometry in the **Label** text field.
- 3 Locate the **Parameters** section. In the table, enter the following settings:

Name	Expression	Value	Description
t_s	500[um]/25	2E-5 m	Substrate thickness (truncated)
t_i	200[nm]	2E-7 m	Insulator thickness
t_hil	1.82[um]	1.82E-6 m	High impedance layer thickness
t_lil	1.65[um]	1.65E-6 m	Low impedance layer thickness
t_pe	3.35[um]	3.35E-6 m	Piezoelectric layer thickness
t_e	200[nm]	2E-7 m	Electrode thickness
w_ar	200[um]	2E-4 m	Active area width
w_pe	800[um]	8E-4 m	Piezoelectric layer width
w	1000[um]	0.001 m	Device width

Enter material parameters. Then calculate the Young's Modulus from the density and acoustic velocity for each linear material. Also calculate the wavelength in the substrate for an estimate of the PML thickness. A guessed value of  $1.5e-4$  is used for an isotropic damping factor as in the case of the 2D model. The parameters  $p1 \sim p6$  will be used to switch on/off each of the 6 particles attached to the active area of the sensor by scaling the material density.

### Parameters 2 - Material properties

- 1 In the **Home** toolbar, click **Pi Parameters** and choose **Add>Parameters**.
- 2 In the **Settings** window for **Parameters**, type Parameters 2 - Material properties in the **Label** text field.
- 3 Locate the **Parameters** section. In the table, enter the following settings:

Name	Expression	Value	Description
rho_ZnO	5680[kg/m^3]	5680 kg/m <sup>3</sup>	Density of ZnO
rho_Mo	10200[kg/m^3]	10200 kg/m <sup>3</sup>	Density of Mo
rho_SiO2	2170[kg/m^3]	2170 kg/m <sup>3</sup>	Density of SiO2
rho_Al	2700[kg/m^3]	2700 kg/m <sup>3</sup>	Density of Al

Name	Expression	Value	Description
rho_Si	2330[kg/m^3]	2330 kg/m <sup>3</sup>	Density of Si
v_ZnO	6330[m/s]	6330 m/s	Acoustic velocity of ZnO
v_Mo	6280[m/s]	6280 m/s	Acoustic velocity_of Mo
v_SiO2	5540[m/s]	5540 m/s	Acoustic velocity of SiO2
v_Al	6450[m/s]	6450 m/s	Acoustic velocity of Al
v_Si	8320[m/s]	8320 m/s	Acoustic velocity of Si
E_Mo	rho_Mo*(v_Mo)^2	4.0227E11 Pa	Young's modulus of Mo
E_SiO2	rho_SiO2*(v_SiO2)^2	6.6601E10 Pa	Young's modulus of SiO2
E_Al	rho_Al*(v_Al)^2	1.1233E11 Pa	Young's modulus of Al
E_Si	rho_Si*(v_Si)^2	1.6129E11 Pa	Young's modulus of Si
eta0	1.5e-4	1.5E-4	Loss factor (guessed)
lambda_Si	v_Si/870[MHz]	9.5632E-6 m	Wavelength in Si
p1	0	0	Switch for particle 1
p2	0	0	Switch for particle 2
p3	0	0	Switch for particle 3
p4	0	0	Switch for particle 4
p5	0	0	Switch for particle 5
p6	0	0	Switch for particle 6

Build the parameterized geometry. Only 1/4 of the geometry will be built due to symmetry. Note how the selection and cumulative selection functionalities will be used to created named selections for material and physics settings later.

## GEOMETRY I

### *Piezo - ZnO*

- 1 In the **Geometry** toolbar, click  **Block**.
- 2 In the **Settings** window for **Block**, type Piezo - ZnO in the **Label** text field.
- 3 Locate the **Size and Shape** section. In the **Width** text field, type  $w_{pe}/2$ .
- 4 In the **Depth** text field, type  $w_{pe}/2$ .
- 5 In the **Height** text field, type  $t_{pe}$ .
- 6 Locate the **Selections of Resulting Entities** section. Select the **Resulting objects selection** check box.

### *Bottom electrode*

- 1 Right-click **Piezo - ZnO** and choose **Duplicate**.
- 2 In the **Settings** window for **Block**, type Bottom electrode in the **Label** text field.
- 3 Locate the **Size and Shape** section. In the **Height** text field, type  $t_e$ .
- 4 Locate the **Position** section. In the **z** text field, type  $-t_e$ .
- 5 Locate the **Selections of Resulting Entities** section. From the **Show in physics** list, choose **All levels**.
- 6 Find the **Cumulative selection** subsection. Click **New**.
- 7 In the **New Cumulative Selection** dialog box, type A1 in the **Name** text field.
- 8 Click **OK**.

### *Top electrode*

- 1 Right-click **Bottom electrode** and choose **Duplicate**.
- 2 In the **Settings** window for **Block**, type Top electrode in the **Label** text field.
- 3 Locate the **Size and Shape** section. In the **Width** text field, type  $w_{ar}/2$ .
- 4 In the **Depth** text field, type  $w_{ar}/2$ .
- 5 Locate the **Position** section. In the **z** text field, type  $t_{pe}$ .

### *Low impedance - SiO2*

- 1 In the **Geometry** toolbar, click  **Block**.
- 2 In the **Settings** window for **Block**, type Low impedance - SiO2 in the **Label** text field.
- 3 Locate the **Size and Shape** section. In the **Width** text field, type  $w/2$ .
- 4 In the **Depth** text field, type  $w/2$ .
- 5 In the **Height** text field, type  $t_{li1}$ .

- 6 Locate the **Position** section. In the **z** text field, type  $-t_{l1l}-t_e$ .
- 7 Click to expand the **Layers** section. In the table, enter the following settings:

Layer name	Thickness ( $\mu\text{m}$ )
Layer 1	$(w-w_{pe})/2$

- 8 Find the **Layer position** subsection. Select the **Right** check box.
- 9 Select the **Back** check box.
- 10 Clear the **Bottom** check box.
- 11 Locate the **Selections of Resulting Entities** section. Find the **Cumulative selection** subsection. Click **New**.
- 12 In the **New Cumulative Selection** dialog box, type SiO2 in the **Name** text field.
- 13 Click **OK**.



#### *Array - SiO2*

- 1 In the **Geometry** toolbar, click  **Transforms** and choose **Array**.
- 2 In the **Settings** window for **Array**, type Array - SiO2 in the **Label** text field.
- 3 Locate the **Selections of Resulting Entities** section. Select the **Resulting objects selection** check box.
- 4 Locate the **Input** section. From the **Input objects** list, choose **SiO2**.
- 5 Locate the **Size** section. In the **z size** text field, type 3.
- 6 Locate the **Displacement** section. In the **z** text field, type  $-t_{l1l}-t_{hil}$ .

#### *High impedance - Mo*

- 1 In the **Model Builder** window, under **Component 1 (comp1)>Geometry 1** right-click **Low impedance - SiO2 (blk4)** and choose **Duplicate**.
- 2 In the **Settings** window for **Block**, type High impedance - Mo in the **Label** text field.
- 3 Locate the **Size and Shape** section. In the **Height** text field, type  $t_{hil}$ .
- 4 Locate the **Position** section. In the **z** text field, type  $-t_{hil}-t_{l1l}-t_e$ .
- 5 Locate the **Selections of Resulting Entities** section. Find the **Cumulative selection** subsection. Click **New**.
- 6 In the **New Cumulative Selection** dialog box, type Mo in the **Name** text field.
- 7 Click **OK**.

#### *Array - Mo*

- 1 In the **Model Builder** window, under **Component 1 (comp1)>Geometry 1** right-click **Array - SiO2 (arr1)** and choose **Duplicate**.
- 2 In the **Settings** window for **Array**, type Array - Mo in the **Label** text field.
- 3 Locate the **Input** section. Find the **Input objects** subsection. Click to select the  **Activate Selection** toggle button.
- 4 From the **Input objects** list, choose **Mo**.
- 5 Click  **Build Selected**.

#### *Insulator - SiO2*

- 1 In the **Model Builder** window, under **Component 1 (comp1)>Geometry 1** right-click **Low impedance - SiO2 (blk4)** and choose **Duplicate**.
- 2 In the **Settings** window for **Block**, type Insulator - SiO2 in the **Label** text field.
- 3 Locate the **Size and Shape** section. In the **Height** text field, type  $t_i$ .
- 4 Locate the **Position** section. In the **z** text field, type  $-3*t_{hil}-3*t_{lil}-t_e-t_i$ .

#### *Substrate - Si*

- 1 Right-click **Insulator - SiO2** and choose **Duplicate**.
- 2 In the **Settings** window for **Block**, type Substrate - Si in the **Label** text field.
- 3 Locate the **Size and Shape** section. In the **Height** text field, type  $t_s$ .
- 4 Locate the **Position** section. In the **z** text field, type  $-3*t_{hil}-3*t_{lil}-t_e-t_i-t_s$ .
- 5 Locate the **Selections of Resulting Entities** section. Select the **Resulting objects selection** check box.
- 6 Find the **Cumulative selection** subsection. Click **New**.
- 7 In the **New Cumulative Selection** dialog box, type Si in the **Name** text field.
- 8 Click **OK**.

#### *Bottom PML - Si*

- 1 Right-click **Substrate - Si** and choose **Duplicate**.
- 2 In the **Settings** window for **Block**, type Bottom PML - Si in the **Label** text field.
- 3 Locate the **Size and Shape** section. In the **Height** text field, type  $\lambda_{Si}$ .
- 4 Locate the **Position** section. In the **z** text field, type  $-3*t_{hil}-3*t_{lil}-t_e-t_i-t_s-\lambda_{Si}$ .

Add 6 blocks at arbitrarily chosen locations on top of the active area to represent particles of 1 micron size attached to the sensor. These will be activated or deactivated using the parameters p1 ~ p6 as described earlier.

#### *Particle 1*

- 1 In the **Geometry** toolbar, click  **Block**.
- 2 In the **Settings** window for **Block**, type Particle 1 in the **Label** text field.
- 3 Locate the **Position** section. In the **x** text field, type 15.
- 4 In the **y** text field, type 25.
- 5 In the **z** text field, type t\_pe+t\_e.
- 6 Locate the **Selections of Resulting Entities** section. Select the **Resulting objects selection** check box.
- 7 Find the **Cumulative selection** subsection. Click **New**.
- 8 In the **New Cumulative Selection** dialog box, type Particles in the **Name** text field.
- 9 Click **OK**.

#### *Particle 2*

- 1 Right-click **Particle 1** and choose **Duplicate**.
- 2 In the **Settings** window for **Block**, type Particle 2 in the **Label** text field.
- 3 Locate the **Position** section. In the **x** text field, type 50.
- 4 In the **y** text field, type 15.

#### *Particle 3*

- 1 Right-click **Particle 2** and choose **Duplicate**.
- 2 In the **Settings** window for **Block**, type Particle 3 in the **Label** text field.
- 3 Locate the **Position** section. In the **x** text field, type 39.
- 4 In the **y** text field, type 51.

#### *Particle 4*

- 1 Right-click **Particle 3** and choose **Duplicate**.
- 2 In the **Settings** window for **Block**, type Particle 4 in the **Label** text field.
- 3 Locate the **Position** section. In the **x** text field, type 55.
- 4 In the **y** text field, type 35.

#### *Particle 5*

- 1 Right-click **Particle 4** and choose **Duplicate**.



- 2 In the **Settings** window for **Block**, type Particle 5 in the **Label** text field.
- 3 Locate the **Position** section. In the **x** text field, type 62.
- 4 In the **y** text field, type 80.

*Particle 6*

- 1 Right-click **Particle 5** and choose **Duplicate**.
- 2 In the **Settings** window for **Block**, type Particle 6 in the **Label** text field.
- 3 Locate the **Position** section. In the **x** text field, type 85.
- 4 In the **y** text field, type 55.
- 5 In the **Geometry** toolbar, click  **Build All**.

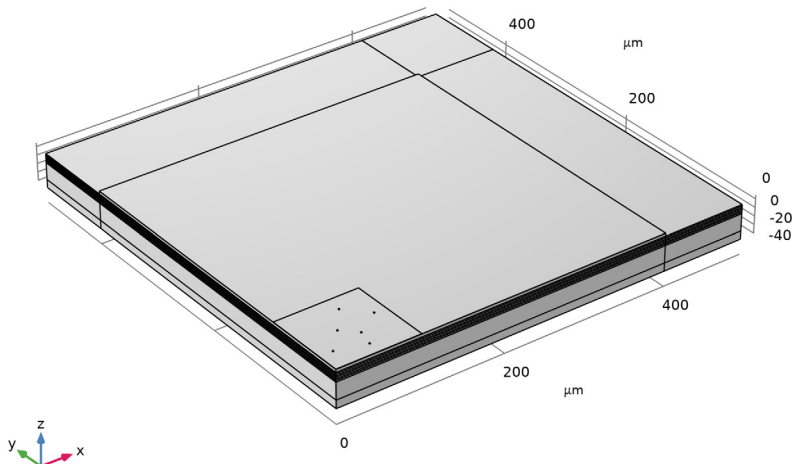

Create selections for the PML, symmetry boundary condition, fixed boundary condition, the top surfaces of the particles, and the acoustic mirror. Use wireframe rendering to more easily see the defined selections.

**DEFINITIONS**

*Symmetry BC 1*

- 1 In the **Definitions** toolbar, click  **Box**.
- 2 In the **Settings** window for **Box**, type Symmetry BC 1 in the **Label** text field.

- 3 Locate the **Geometric Entity Level** section. From the **Level** list, choose **Boundary**.
- 4 Locate the **Box Limits** section. In the **x maximum** text field, type eps.
- 5 Locate the **Output Entities** section. From the **Include entity if** list, choose **Entity inside box**.
- 6 Click the  **Wireframe Rendering** button in the **Graphics** toolbar.

#### *Symmetry BC 2*

- 1 Right-click **Symmetry BC 1** and choose **Duplicate**.
- 2 In the **Settings** window for **Box**, type Symmetry BC 2 in the **Label** text field.
- 3 Locate the **Box Limits** section. In the **x maximum** text field, type Inf.
- 4 In the **y maximum** text field, type eps.

#### *Fixed BC bottom*

- 1 Right-click **Symmetry BC 2** and choose **Duplicate**.
- 2 In the **Settings** window for **Box**, type Fixed BC bottom in the **Label** text field.
- 3 Locate the **Box Limits** section. In the **y maximum** text field, type Inf.
- 4 In the **z maximum** text field, type  $-3*t_{hil}-3*t_{lil}-t_e-t_i-t_s-\lambda_{Si}/2$ .



#### *Fixed BC side 1*

- 1 Right-click **Fixed BC bottom** and choose **Duplicate**.
- 2 In the **Settings** window for **Box**, type Fixed BC side 1 in the **Label** text field.
- 3 Locate the **Box Limits** section. In the **x minimum** text field, type  $(w/2+w_{pe}/2)/2$ .
- 4 In the **z maximum** text field, type Inf.

#### *Fixed BC side 2*

- 1 Right-click **Fixed BC side 1** and choose **Duplicate**.
- 2 In the **Settings** window for **Box**, type Fixed BC side 2 in the **Label** text field.
- 3 Locate the **Box Limits** section. In the **x minimum** text field, type -Inf.
- 4 In the **y minimum** text field, type  $(w/2+w_{pe}/2)/2$ .

#### *Fixed BC*

- 1 In the **Definitions** toolbar, click  **Union**.
- 2 In the **Settings** window for **Union**, type Fixed BC in the **Label** text field.
- 3 Locate the **Geometric Entity Level** section. From the **Level** list, choose **Boundary**.
- 4 Locate the **Input Entities** section. Under **Selections to add**, click  **Add**.

5 In the **Add** dialog box, in the **Selections to add** list, choose **Fixed BC bottom**, **Fixed BC side 1**, and **Fixed BC side 2**.

6 Click **OK**.

#### *Not PML*

1 In the **Definitions** toolbar, click  **Box**.

2 In the **Settings** window for **Box**, type Not PML in the **Label** text field.

3 Locate the **Box Limits** section. In the **x maximum** text field, type  $(w/2+w_{pe}/2)/2$ .

4 In the **y maximum** text field, type  $(w/2+w_{pe}/2)/2$ .

5 In the **z minimum** text field, type  $-3*t_{hil}-3*t_{lil}-t_e-t_i-t_s-\lambda_{Si}/2$ .

6 Locate the **Output Entities** section. From the **Include entity if** list, choose **Entity inside box**.

#### *PML*

1 In the **Definitions** toolbar, click  **Complement**.

2 In the **Settings** window for **Complement**, type PML in the **Label** text field.

3 Locate the **Input Entities** section. Under **Selections to invert**, click **+ Add**.

4 In the **Add** dialog box, select **Not PML** in the **Selections to invert** list.

5 Click **OK**.

#### *Top surfaces of particles*

1 In the **Model Builder** window, right-click **Fixed BC bottom** and choose **Duplicate**.

2 In the **Settings** window for **Box**, type Top surfaces of particles in the **Label** text field.

3 Locate the **Box Limits** section. In the **z minimum** text field, type  $t_{pe}+t_e+1/2$ .

4 In the **z maximum** text field, type Inf.

#### *Acoustic mirror*

1 In the **Definitions** toolbar, click  **Union**.

2 In the **Settings** window for **Union**, type Acoustic mirror in the **Label** text field.

3 Locate the **Input Entities** section. Under **Selections to add**, click **+ Add**.

4 In the **Add** dialog box, in the **Selections to add** list, choose **Mo** and **Array - SiO2**.

5 Click **OK**.

Create an integration operator over the particle domains to compute the attached particle mass.

### *Integration - Particles*

- 1 In the **Definitions** toolbar, click  **Nonlocal Couplings** and choose **Integration**.
- 2 In the **Settings** window for **Integration**, type **Integration - Particles** in the **Label** text field.
- 3 Locate the **Source Selection** section. From the **Selection** list, choose **Particles**.

Create the Perfectly Matched Layers.

### *Perfectly Matched Layer 1 (pml1)*

- 1 In the **Definitions** toolbar, click  **Perfectly Matched Layer**.
- 2 In the **Settings** window for **Perfectly Matched Layer**, locate the **Domain Selection** section.
- 3 From the **Selection** list, choose **PML**.

Before adding material properties, set up the physics settings, so that the required properties will be highlighted when adding materials. Use the selections made earlier for the physics selections. For Solid Mechanics: add damping subnodes, symmetry boundary conditions, and fixed boundary conditions.

## **SOLID MECHANICS (SOLID)**

### *Linear Elastic Material 1*

In the **Model Builder** window, under **Component 1 (comp1)>Solid Mechanics (solid)** click **Linear Elastic Material 1**.

### *Damping 1*

- 1 In the **Physics** toolbar, click  **Attributes** and choose **Damping**.
- 2 In the **Settings** window for **Damping**, locate the **Damping Settings** section.
- 3 From the **Damping type** list, choose **Isotropic loss factor**.

### *Piezoelectric Material 1*

- 1 In the **Model Builder** window, under **Component 1 (comp1)>Solid Mechanics (solid)** click **Piezoelectric Material 1**.
- 2 In the **Settings** window for **Piezoelectric Material**, locate the **Domain Selection** section.
- 3 From the **Selection** list, choose **Piezo - ZnO**.

### *Mechanical Damping 1*

In the **Physics** toolbar, click  **Attributes** and choose **Mechanical Damping**.

### *Fixed Constraint 1*

- 1 In the **Physics** toolbar, click  **Boundaries** and choose **Fixed Constraint**.

- 2 In the **Settings** window for **Fixed Constraint**, locate the **Boundary Selection** section.
- 3 From the **Selection** list, choose **Fixed BC**.

#### *Symmetry 1*

- 1 In the **Physics** toolbar, click  **Boundaries** and choose **Symmetry**.
- 2 In the **Settings** window for **Symmetry**, locate the **Boundary Selection** section.
- 3 From the **Selection** list, choose **Symmetry BC 1**.

#### *Symmetry 2*

- 1 In the **Physics** toolbar, click  **Boundaries** and choose **Symmetry**.
- 2 In the **Settings** window for **Symmetry**, locate the **Boundary Selection** section.
- 3 From the **Selection** list, choose **Symmetry BC 2**.

For Electrostatics: only the domain surrounded by electrodes (the piezo domain) needs to be selected. Use the Terminal boundary condition (not the Electric Potential boundary condition) for the excitation port, so that lumped electrical parameters will be computed automatically. Drive the terminal with a voltage of 1 V.

### **ELECTROSTATICS (ES)**

- 1 In the **Model Builder** window, under **Component 1 (comp1)** click **Electrostatics (es)**.
- 2 In the **Settings** window for **Electrostatics**, locate the **Domain Selection** section.
- 3 From the **Selection** list, choose **Piezo - ZnO**.

#### *Ground 1*

- 1 In the **Physics** toolbar, click  **Boundaries** and choose **Ground**.
- 2 In the **Settings** window for **Ground**, locate the **Boundary Selection** section.
- 3 From the **Selection** list, choose **Bottom electrode**.

#### *Terminal 1*

- 1 In the **Physics** toolbar, click  **Boundaries** and choose **Terminal**.
- 2 In the **Settings** window for **Terminal**, locate the **Boundary Selection** section.
- 3 From the **Selection** list, choose **Top electrode**.
- 4 Locate the **Terminal** section. From the **Terminal type** list, choose **Voltage**.

The domain and physics selections of the Piezoelectric Effect multiphysics coupling should be set up automatically.

## MULTIPHYSICS

### *Piezoelectric Effect 1 (pze1)*

Add material properties from the COMSOL Piezoelectric, MEMS, and Built-in material folders as an initial template. Then enter the available data from the reference paper using the parameters prepared earlier under **Parameters 2 - Material properties**.

#### ADD MATERIAL

- 1 In the **Home** toolbar, click  **Add Material** to open the **Add Material** window.
- 2 Go to the **Add Material** window.
- 3 In the tree, select **Piezoelectric>Zinc Oxide**.
- 4 Click **Add to Component** in the window toolbar.

#### MATERIALS

### *Zinc Oxide (mat1)*

- 1 In the **Settings** window for **Material**, locate the **Geometric Entity Selection** section.
- 2 From the **Selection** list, choose **Piezo - ZnO**.
- 3 Locate the **Material Contents** section. In the table, enter the following settings:

Property	Variable	Value	Unit	Property group
Density	rho	rho_Zn0	kg/m <sup>3</sup>	Basic
Loss factor for elasticity matrix cE	eta_cE_iso ; eta_cEii = eta_cE_iso, eta_cEij = 0	eta0	l	Stress-charge form

#### ADD MATERIAL

- 1 Go to the **Add Material** window.
- 2 In the tree, select **MEMS>Metals>Al - Aluminum**.
- 3 Click **Add to Component** in the window toolbar.

#### MATERIALS

### *Al - Aluminum (mat2)*

- 1 In the **Settings** window for **Material**, locate the **Geometric Entity Selection** section.
- 2 From the **Selection** list, choose **Al**.

3 Locate the **Material Contents** section. In the table, enter the following settings:

Property	Variable	Value	Unit	Property group
Isotropic structural loss factor	eta_s	eta0	l	Basic
Density	rho	rho_A1	kg/m <sup>3</sup>	Basic
Young's modulus	E	E_A1	Pa	Young's modulus and Poisson's ratio

#### ADD MATERIAL

- 1 Go to the **Add Material** window.
- 2 In the tree, select **MEMS>Insulators>SiO2 - Silicon oxide**.
- 3 Click **Add to Component** in the window toolbar.

#### MATERIALS

*SiO2 - Silicon oxide (mat3)*

- 1 In the **Settings** window for **Material**, locate the **Geometric Entity Selection** section.
- 2 From the **Selection** list, choose **SiO2**.
- 3 Locate the **Material Contents** section. In the table, enter the following settings:

Property	Variable	Value	Unit	Property group
Isotropic structural loss factor	eta_s	eta0	l	Basic
Density	rho	rho_SiO2	kg/m <sup>3</sup>	Basic
Young's modulus	E	E_SiO2	Pa	Young's modulus and Poisson's ratio

#### ADD MATERIAL

- 1 Go to the **Add Material** window.
- 2 In the tree, select **MEMS>Semiconductors>Si - Silicon (single-crystal, isotropic)**.
- 3 Click **Add to Component** in the window toolbar.

#### MATERIALS

*Si - Silicon (single-crystal, isotropic) (mat4)*

- 1 In the **Settings** window for **Material**, locate the **Geometric Entity Selection** section.
- 2 From the **Selection** list, choose **Si**.

3 Locate the **Material Contents** section. In the table, enter the following settings:

Property	Variable	Value	Unit	Property group
Isotropic structural loss factor	eta_s	eta0	l	Basic
Density	rho	rho_Si	kg/m <sup>3</sup>	Basic
Young's modulus	E	E_Si	Pa	Young's modulus and Poisson's ratio

### ADD MATERIAL

- 1 Go to the **Add Material** window.
- 2 In the tree, select **Built-in>Molybdenum**.
- 3 Click **Add to Component** in the window toolbar.
- 4 In the **Home** toolbar, click  **Add Material** to close the **Add Material** window.

### MATERIALS

*Molybdenum (mat5)*

- 1 In the **Settings** window for **Material**, locate the **Geometric Entity Selection** section.
- 2 From the **Selection** list, choose **Mo**.
- 3 Locate the **Material Contents** section. In the table, enter the following settings:

Property	Variable	Value	Unit	Property group
Isotropic structural loss factor	eta_s	eta0	l	Basic
Density	rho	rho_Mo	kg/m <sup>3</sup>	Basic
Young's modulus	E	E_Mo	Pa	Young's modulus and Poisson's ratio

For the particle material, duplicated the SiO<sub>2</sub> material node and define a variable p for each particle domain using the corresponding parameters p<sub>1</sub> ~ p<sub>6</sub> to scale the density of each particle accordingly (as a way to switch each particle on and off).

### DEFINITIONS

*Variables - Particle 1*

- 1 In the **Model Builder** window, under **Component 1 (comp1)** right-click **Definitions** and choose **Variables**.



- 2 In the **Settings** window for **Variables**, type Variables - Particle 1 in the **Label** text field.
- 3 Locate the **Geometric Entity Selection** section. From the **Geometric entity level** list, choose **Domain**.
- 4 From the **Selection** list, choose **Particle 1**.
- 5 Locate the **Variables** section. In the table, enter the following settings:

Name	Expression	Unit	Description
p	p1		Switch for particle 1

*Variables - Particle 2*

- 1 Right-click **Variables - Particle 1** and choose **Duplicate**.
- 2 In the **Settings** window for **Variables**, type Variables - Particle 2 in the **Label** text field.
- 3 Locate the **Geometric Entity Selection** section. From the **Selection** list, choose **Particle 2**.
- 4 Locate the **Variables** section. In the table, enter the following settings:

Name	Expression	Unit	Description
p	p2		Switch for particle 2

*Variables - Particle 3*

- 1 Right-click **Variables - Particle 2** and choose **Duplicate**.
- 2 In the **Settings** window for **Variables**, type Variables - Particle 3 in the **Label** text field.
- 3 Locate the **Geometric Entity Selection** section. From the **Selection** list, choose **Particle 3**.
- 4 Locate the **Variables** section. In the table, enter the following settings:

Name	Expression	Unit	Description
p	p3		Switch for particle 3

*Variables - Particle 4*

- 1 Right-click **Variables - Particle 3** and choose **Duplicate**.
- 2 In the **Settings** window for **Variables**, type Variables - Particle 4 in the **Label** text field.
- 3 Locate the **Geometric Entity Selection** section. From the **Selection** list, choose **Particle 4**.

4 Locate the **Variables** section. In the table, enter the following settings:

Name	Expression	Unit	Description
p	p4		Switch for particle 4

#### *Variables - Particle 5*

- 1 Right-click **Variables - Particle 4** and choose **Duplicate**.
- 2 In the **Settings** window for **Variables**, type Variables - Particle 5 in the **Label** text field.
- 3 Locate the **Geometric Entity Selection** section. From the **Selection** list, choose **Particle 5**.
- 4 Locate the **Variables** section. In the table, enter the following settings:

Name	Expression	Unit	Description
p	p5		Switch for particle 5

#### *Variables - Particle 6*

- 1 Right-click **Variables - Particle 5** and choose **Duplicate**.
- 2 In the **Settings** window for **Variables**, type Variables - Particle 6 in the **Label** text field.
- 3 Locate the **Geometric Entity Selection** section. From the **Selection** list, choose **Particle 6**.
- 4 Locate the **Variables** section. In the table, enter the following settings:

Name	Expression	Unit	Description
p	p6		Switch for particle 6

## **MATERIALS**

### *SiO2 Particles*

- 1 In the **Model Builder** window, under **Component 1 (comp1)>Materials** right-click **SiO2 - Silicon oxide (mat3)** and choose **Duplicate**.
- 2 In the **Settings** window for **Material**, type SiO2 Particles in the **Label** text field.
- 3 Locate the **Geometric Entity Selection** section. From the **Selection** list, choose **Particles**.
- 4 Locate the **Material Contents** section. In the table, enter the following settings:

Property	Variable	Value	Unit	Property group
Density	rho	p*rho_SiO2	kg/m <sup>3</sup>	Basic

- 5 Click the  **Zoom to Selection** button in the **Graphics** toolbar.

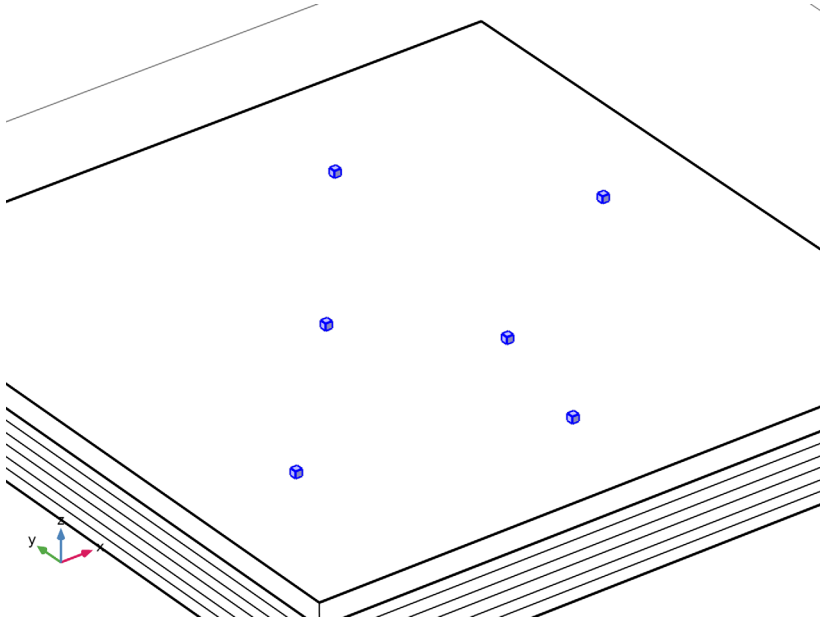

To save time and file size, a relatively coarse mesh will be used, in particular in the horizontal direction. Thus only the main lower modes will be resolved in this model. The same approach was taken in the reference paper. The general approach in the following meshing procedure is: Starting from the top surfaces, build triangular mesh on the surfaces and then sweep downwards, except for the PMLs, which should use mapped mesh and then sweep downwards.

## MESH 1

### *Free Triangular - Top surfaces of particles*

- 1 In the **Mesh** toolbar, click  **Boundary** and choose **Free Triangular**.
- 2 In the **Settings** window for **Free Triangular**, type Free Triangular - Top surfaces of particles in the **Label** text field.
- 3 Locate the **Boundary Selection** section. From the **Selection** list, choose **Top surfaces of particles**.

### *Swept - Particles*

- 1 In the **Mesh** toolbar, click  **Swept**.
- 2 In the **Settings** window for **Swept**, type Swept - Particles in the **Label** text field.

- 3 Locate the **Domain Selection** section. From the **Geometric entity level** list, choose **Domain**.
- 4 From the **Selection** list, choose **Particles**.

#### *Distribution 1*

- 1 Right-click **Swept - Particles** and choose **Distribution**.
- 2 In the **Settings** window for **Distribution**, locate the **Distribution** section.
- 3 In the **Number of elements** text field, type 3.



#### *Free Triangular - Top electrode*

- 1 In the **Mesh** toolbar, click  **Boundary** and choose **Free Triangular**.
- 2 In the **Settings** window for **Free Triangular**, type Free Triangular - Top electrode in the **Label** text field.
- 3 Select Boundary 37 only.

#### *Size 1*

- 1 Right-click **Free Triangular - Top electrode** and choose **Size**.
- 2 In the **Settings** window for **Size**, locate the **Element Size** section.
- 3 Click the **Custom** button.
- 4 Locate the **Element Size Parameters** section.
- 5 Select the **Maximum element size** check box. In the associated text field, type 10.
- 6 Select the **Minimum element size** check box. In the associated text field, type 1.

#### *Swept - Top electrode*

- 1 In the **Mesh** toolbar, click  **Swept**.
- 2 In the **Settings** window for **Swept**, type Swept - Top electrode in the **Label** text field.
- 3 Locate the **Domain Selection** section. From the **Geometric entity level** list, choose **Domain**.
- 4 From the **Selection** list, choose **Top electrode**.
- 5 Click  **Build All**.

- 6 Click the  **Zoom to Selection** button in the **Graphics** toolbar.

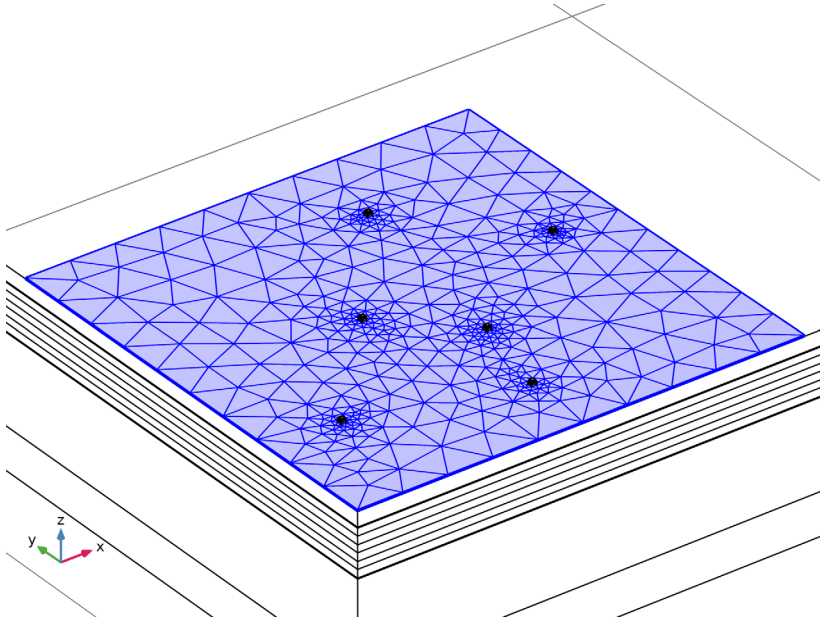

#### *Free Triangular - Piezo*

- 1 In the **Mesh** toolbar, click  **Boundary** and choose **Free Triangular**.
- 2 In the **Settings** window for **Free Triangular**, type Free Triangular - Piezo in the **Label** text field.
- 3 Select Boundary 39 only.

#### *Swept - Piezo*



- 1 In the **Mesh** toolbar, click  **Swept**.
- 2 In the **Settings** window for **Swept**, type Swept - Piezo in the **Label** text field.
- 3 Locate the **Domain Selection** section. From the **Geometric entity level** list, choose **Domain**.
- 4 From the **Selection** list, choose **Piezo - ZnO**.

#### *Distribution 1*

- 1 Right-click **Swept - Piezo** and choose **Distribution**.
- 2 In the **Settings** window for **Distribution**, locate the **Distribution** section.
- 3 In the **Number of elements** text field, type 6.

#### *Swept - Bottom electrode*

- 1 In the **Mesh** toolbar, click  **Swept**.

- 2 In the **Settings** window for **Swept**, type Swept - Bottom electrode in the **Label** text field.
- 3 Locate the **Domain Selection** section. From the **Geometric entity level** list, choose **Domain**.
- 4 From the **Selection** list, choose **Bottom electrode**.
- 5 Click  **Build All**.
- 6 Click the  **Zoom to Selection** button in the **Graphics** toolbar.

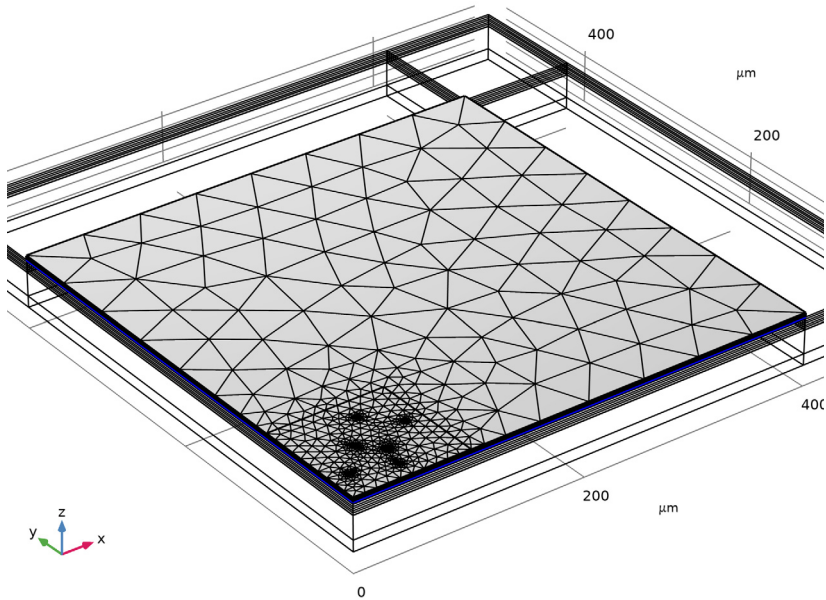

#### *Mapped - PML*

- 1 In the **Mesh** toolbar, click  **Boundary** and choose **Mapped**.
- 2 In the **Settings** window for **Mapped**, type Mapped - PML in the **Label** text field.
- 3 Select Boundaries 68, 144, and 173 only.
- 4 Click to expand the **Reduce Element Skewness** section. Select the **Adjust edge mesh** check box.

#### *Distribution 1*

- 1 Right-click **Mapped - PML** and choose **Distribution**.
- 2 Select Edges 233 and 234 only.
- 3 In the **Settings** window for **Distribution**, locate the **Distribution** section.
- 4 In the **Number of elements** text field, type 3.

### *Swept - Acoustic mirror*

- 1 In the **Mesh** toolbar, click  **Swept**.
- 2 In the **Settings** window for **Swept**, type Swept - Acoustic mirror in the **Label** text field.
- 3 Locate the **Domain Selection** section. From the **Geometric entity level** list, choose **Domain**.
- 4 From the **Selection** list, choose **Acoustic mirror**.

### *Distribution 1*

- 1 Right-click **Swept - Acoustic mirror** and choose **Distribution**.
- 2 In the **Settings** window for **Distribution**, locate the **Distribution** section.
- 3 In the **Number of elements** text field, type 3.



### *Swept - Remaining*

- 1 In the **Mesh** toolbar, click  **Swept**.
- 2 In the **Settings** window for **Swept**, type Swept - Remaining in the **Label** text field.

### *Distribution - Substrate*

- 1 Right-click **Swept - Remaining** and choose **Distribution**.
- 2 In the **Settings** window for **Distribution**, type Distribution - Substrate in the **Label** text field.
- 3 Locate the **Domain Selection** section. Click  **Clear Selection**.
- 4 From the **Selection** list, choose **Substrate - Si**.
- 5 Locate the **Distribution** section. From the **Distribution type** list, choose **Predefined**.
- 6 In the **Number of elements** text field, type 12.
- 7 In the **Element ratio** text field, type 5.

### *Distribution - PML*

- 1 In the **Model Builder** window, right-click **Swept - Remaining** and choose **Distribution**.
- 2 In the **Settings** window for **Distribution**, type Distribution - PML in the **Label** text field.
- 3 Locate the **Domain Selection** section. Click  **Clear Selection**.
- 4 Select Domain 1 only.
- 5 Locate the **Distribution** section. In the **Number of elements** text field, type 3.
- 6 Click  **Build All**.

- 7 Click the  **Zoom Extents** button in the **Graphics** toolbar.

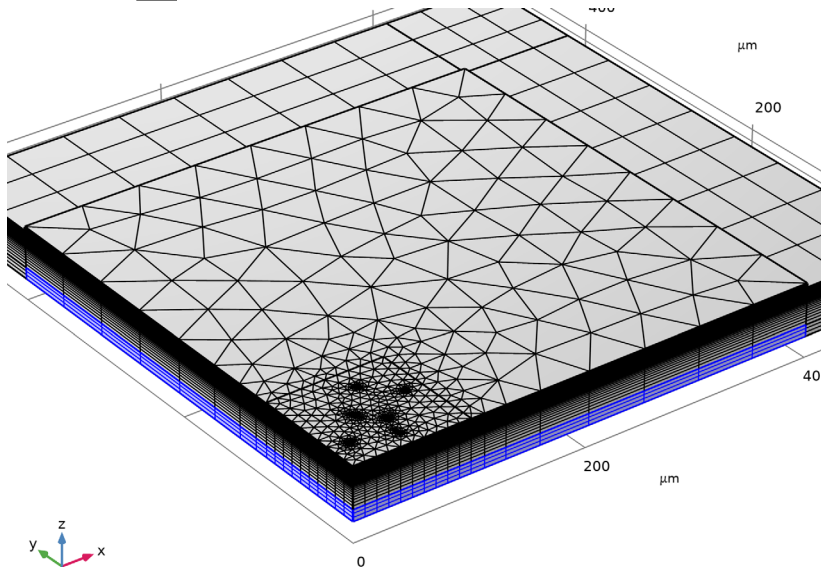

Use the eigenfrequency study to look for the fundamental mode around 870 MHz for a series of specified particles using the Auxiliary sweep.

### **STUDY 1 - EIGENFREQUENCY & SENSITIVITY**

- 1 In the **Model Builder** window, click **Study 1**.
- 2 In the **Settings** window for **Study**, type Study 1 - Eigenfrequency & Sensitivity in the **Label** text field.

#### *Step 1: Eigenfrequency*

- 1 In the **Model Builder** window, under **Study 1 - Eigenfrequency & Sensitivity** click **Step 1: Eigenfrequency**.
- 2 In the **Settings** window for **Eigenfrequency**, locate the **Study Settings** section.
- 3 Select the **Desired number of eigenfrequencies** check box. In the associated text field, type 1.
- 4 Find the **Search region** subsection. From the **Unit** list, choose **MHz**.
- 5 In the **Search for eigenfrequencies around** text field, type 870.6.
- 6 Click to expand the **Study Extensions** section. Select the **Auxiliary sweep** check box.
- 7 Click **+ Add**.



8 In the table, enter the following settings:

Parameter name	Parameter value list	Parameter unit
p1 (Switch for particle 1)	0 0 1 0 0 0 1 1	

9 Click **+** Add.

10 In the table, enter the following settings:

Parameter name	Parameter value list	Parameter unit
p2 (Switch for particle 2)	0 0 1 0 1 0 1 1	

11 Click **+** Add.

12 In the table, enter the following settings:

Parameter name	Parameter value list	Parameter unit
p3 (Switch for particle 3)	0 1 0 0 1 1 1 1	

13 Click **+** Add.

14 In the table, enter the following settings:

Parameter name	Parameter value list	Parameter unit
p4 (Switch for particle 4)	0 0 0 0 0 1 1 1	

15 Click **+** Add.

16 In the table, enter the following settings:

Parameter name	Parameter value list	Parameter unit
p5 (Switch for particle 5)	0 0 0 1 1 1 1 1	

17 Click **+** Add.

18 In the table, enter the following settings:

Parameter name	Parameter value list	Parameter unit
p6 (Switch for particle 6)	0 0 0 1 0 1 0 1	

19 In the **Home** toolbar, click **=** Compute.



## RESULTS

### *Mode Shape (solid)*

Define a selection to exclude the particle surfaces from the mode shape plot. Zoom in to the active region of the sensor to observe the mode shape.

## DEFINITIONS

### *Not particles*

- 1 In the **Definitions** toolbar, click  **Complement**.
- 2 In the **Settings** window for **Complement**, type Not particles in the **Label** text field.
- 3 Locate the **Geometric Entity Level** section. From the **Level** list, choose **Boundary**.
- 4 Locate the **Input Entities** section. Under **Selections to invert**, click  **Add**.
- 5 In the **Add** dialog box, select **Particles** in the **Selections to invert** list.
- 6 Click **OK**.

## RESULTS

### *Selection 1*

- 1 In the **Model Builder** window, expand the **Results>Mode Shape (solid)** node.
- 2 Right-click **Surface 1** and choose **Selection**.
- 3 In the **Settings** window for **Selection**, locate the **Selection** section.
- 4 From the **Selection** list, choose **Not particles**.

### *Deformation*

In the **Model Builder** window, right-click **Deformation** and choose **Disable**.

## ELECTROSTATIC (ES)

### *Terminal 1*

- 1 In the **Model Builder** window, under **Component 1 (comp1)>Electrostatics (es)** click **Terminal 1**.
- 2 In the **Settings** window for **Terminal**, locate the **Boundary Selection** section.
- 3 Click  **Zoom to Selection**.

## RESULTS

### *Mode Shape (solid)*

- 1 In the **Model Builder** window, under **Results** click **Mode Shape (solid)**.

- 2 In the **Settings** window for **3D Plot Group**, locate the **Data** section.
- 3 From the **Parameter value (p1,p2,p3,p4,p5,p6)** list, choose **1: p1=0, p2=0, p3=0, p4=0, p5=0, p6=0**.
- 4 In the **Mode Shape (solid)** toolbar, click  **Plot**.

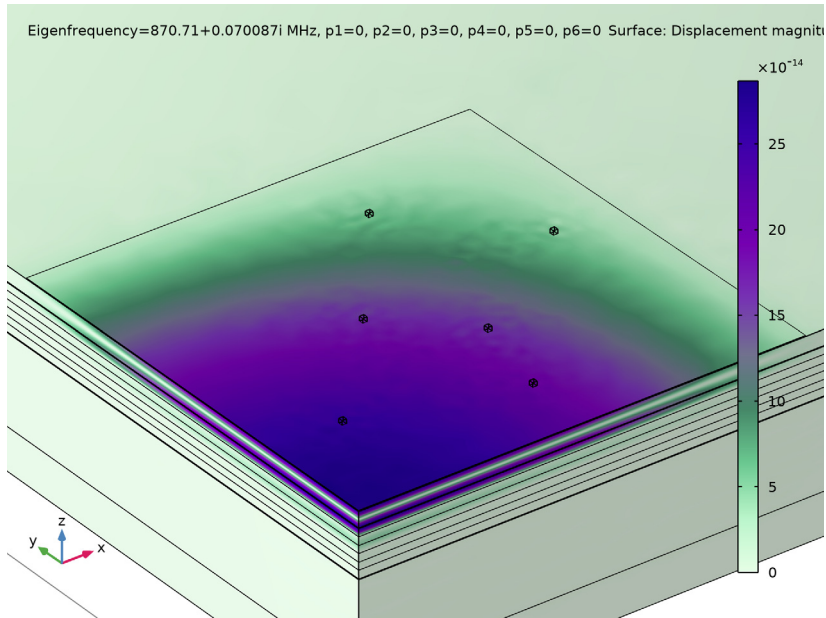

The acoustic mirror effectively confines the mode energy at the top of the structure as expected. A general trend of lower resonant frequency with more attached particle mass is expected and observed.

Also worth noting is that the frequency shift depends strongly on the location of the attached particles relative to the center of the model shape. As an example, compare the following two cases. In the first case, two particles (5 and 6) are attached far away from the center of the model shape, leading to a very small frequency shift:

- 5 From the **Parameter value (p1,p2,p3,p4,p5,p6)** list, choose **4: p1=0, p2=0, p3=0, p4=0, p5=1, p6=1**.

6 In the **Mode Shape (solid)** toolbar, click  **Plot**.

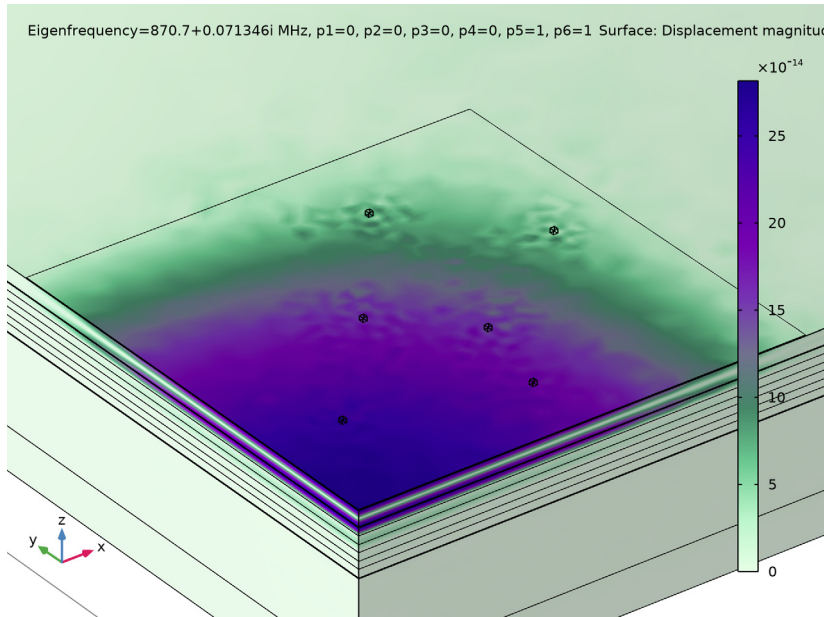

In the second case, two particles (1 and 2) are attached close to the center of the model shape, leading to a visible disturbance of the mode shape and correspondingly a significant frequency shift:

7 From the **Parameter value (p1,p2,p3,p4,p5,p6)** list, choose 3: **p1=1, p2=1, p3=0, p4=0, p5=0, p6=0**.

8 In the **Mode Shape (solid)** toolbar, click  **Plot**.

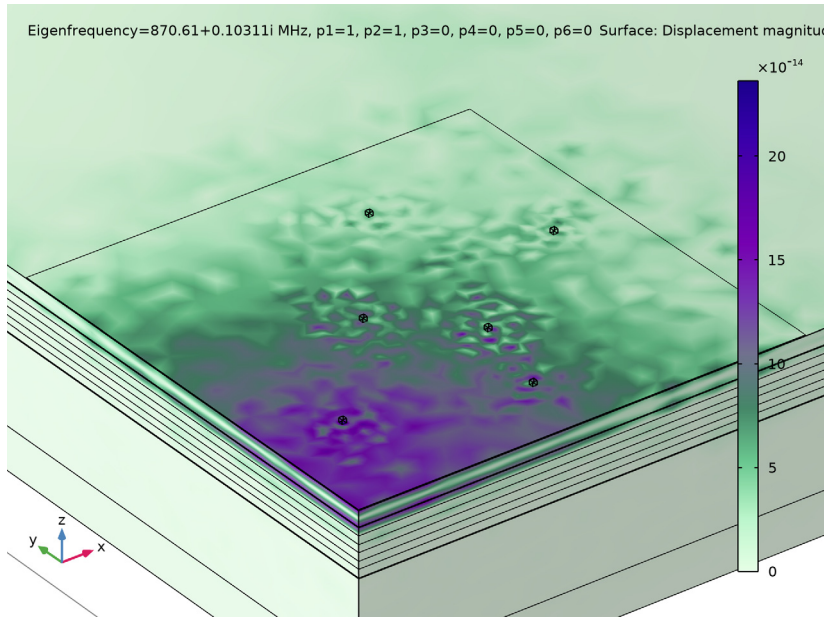

Add a plot of the eigenfrequency versus the attached particle mass to figure out the sensitivity.

#### *Sensitivity*

- 1 In the **Home** toolbar, click  **Add Plot Group** and choose **ID Plot Group**.
- 2 In the **Settings** window for **ID Plot Group**, type **Sensitivity** in the **Label** text field.
- 3 Click to expand the **Title** section. From the **Title type** list, choose **Label**.
- 4 Locate the **Legend** section. Clear the **Show legends** check box.

#### *Global 1*

- 1 Right-click **Sensitivity** and choose **Global**.
- 2 In the **Settings** window for **Global**, locate the **y-Axis Data** section.
- 3 In the table, enter the following settings:

Expression	Unit	Description
freq	MHz	Eigenfrequency

- 4 Locate the **x-Axis Data** section. From the **Axis source data** list, choose **All solutions**.
- 5 From the **Parameter** list, choose **Expression**.

- 6 In the **Expression** text field, type `intop1(solid.rho)`.
- 7 From the **Unit** list, choose **ng**.
- 8 Select the **Description** check box. In the associated text field, type **Added Particle Mass**.
- 9 Click to expand the **Coloring and Style** section. Find the **Line style** subsection. From the **Line** list, choose **None**.
- 10 Find the **Line markers** subsection. From the **Marker** list, choose **Point**.
- 11 In the **Sensitivity** toolbar, click  **Plot**.

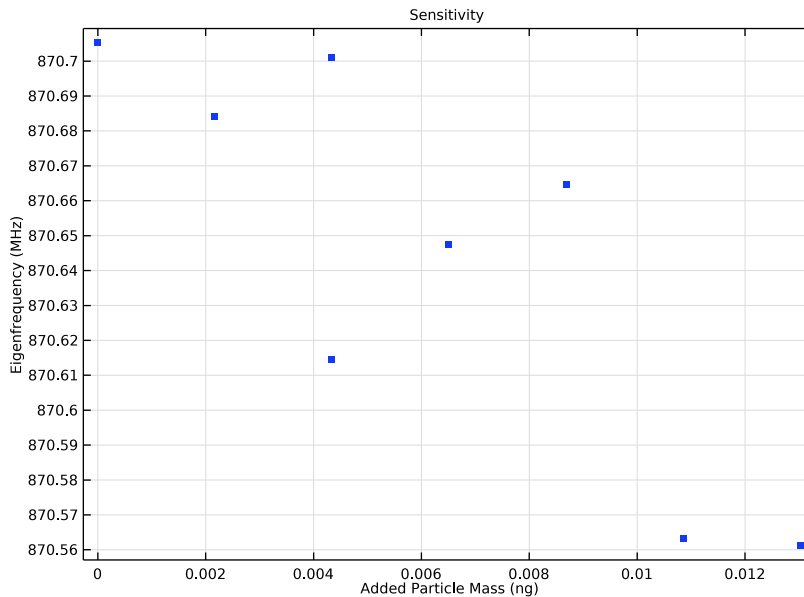

Due to the significant dependence of the frequency shift on the particle attachment location as discussed earlier, it is not possible to arrive at an exact sensitivity number (frequency shift per added particle mass), as evidenced by the scatter of the data points in the graph. A rough number of about 10 MHz/ng can be estimated from the graph.

Add a study to compare the frequency response with versus without particles attached. The frequency list is tailored to only show the main resonance.

#### ADD STUDY

- 1 In the **Home** toolbar, click  **Add Study** to open the **Add Study** window.
- 2 Go to the **Add Study** window.



- 3 Find the **Studies** subsection. In the **Select Study** tree, select **General Studies> Frequency Domain**.
- 4 Click **Add Study** in the window toolbar.
- 5 In the **Home** toolbar, click  **Add Study** to close the **Add Study** window.

## STUDY 2

### Step 1: Frequency Domain

- 1 In the **Settings** window for **Frequency Domain**, locate the **Study Settings** section.
- 2 From the **Frequency unit** list, choose **MHz**.
- 3 Click  **Range**.
- 4 In the **Range** dialog box, type 870.3 in the **Start** text field.
- 5 In the **Step** text field, type 0.05.
- 6 In the **Stop** text field, type 870.9.
- 7 Click **Replace**.
- 8 In the **Model Builder** window, click **Study 2**.
- 9 In the **Settings** window for **Study**, type Study 2 - Frequency response in the **Label** text field.

### Parametric Sweep

- 1 In the **Study** toolbar, click  **Parametric Sweep**.
- 2 In the **Settings** window for **Parametric Sweep**, locate the **Study Settings** section.
- 3 Click  **Add**.
- 4 In the table, enter the following settings:

Parameter name	Parameter value list	Parameter unit
p1 (Switch for particle 1)	0 1	

- 5 Click  **Add**.
- 6 In the table, enter the following settings:

Parameter name	Parameter value list	Parameter unit
p2 (Switch for particle 2)	0 1	

- 7 Click  **Add**.

8 In the table, enter the following settings:

Parameter name	Parameter value list	Parameter unit
p3 (Switch for particle 3)	0 1	

9 Click **+ Add**.

10 In the table, enter the following settings:

Parameter name	Parameter value list	Parameter unit
p4 (Switch for particle 4)	0 1	

11 Click **+ Add**.

12 In the table, enter the following settings:

Parameter name	Parameter value list	Parameter unit
p5 (Switch for particle 5)	0 1	

13 Click **+ Add**.

14 In the table, enter the following settings:

Parameter name	Parameter value list	Parameter unit
p6 (Switch for particle 6)	0 1	

15 In the **Study** toolbar, click **= Compute**.

Take a look at the electric potential solution at the main resonance.

## RESULTS

### *Electric Potential (es) I*

- 1 In the **Model Builder** window, under **Results** click **Electric Potential (es) I**.
- 2 In the **Settings** window for **3D Plot Group**, locate the **Data** section.
- 3 From the **Parameter value (p1,p2,p3,p4,p5,p6)** list, choose **I: p1=0, p2=0, p3=0, p4=0, p5=0, p6=0**.
- 4 From the **Parameter value (freq (MHz))** list, choose **870.75**.

### *Multislice I*

- 1 In the **Model Builder** window, expand the **Electric Potential (es) I** node.
- 2 Right-click **Multislice I** and choose **Disable**.



### Streamline Multislice 1

In the **Model Builder** window, right-click **Streamline Multislice 1** and choose **Disable**.

### Volume 1

- 1 In the **Model Builder** window, right-click **Electric Potential (es) 1** and choose **Volume**.
- 2 In the **Settings** window for **Volume**, locate the **Expression** section.
- 3 In the **Expression** text field, type  $V$ .
- 4 In the **Electric Potential (es) 1** toolbar, click  **Plot**.

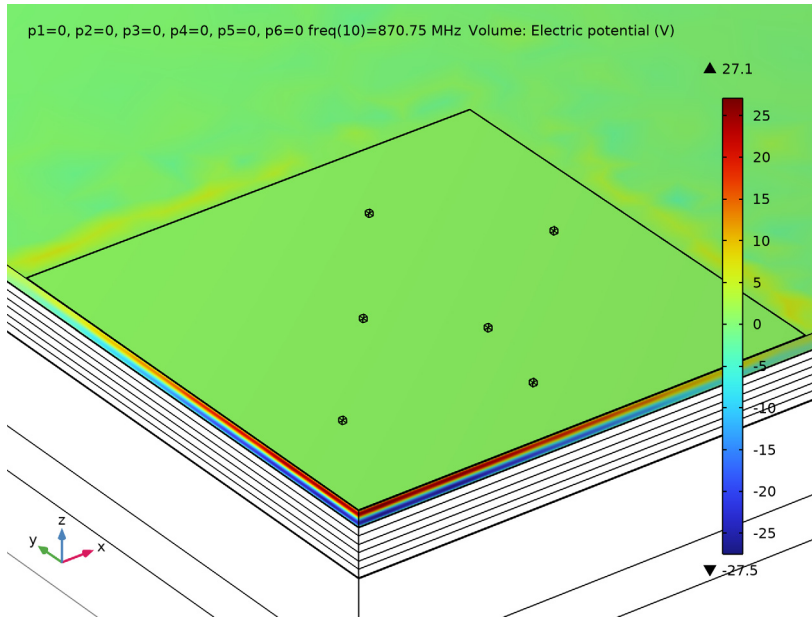

Add plots of the impedance to look at the frequency response curves with and without particles. The resonance peak shifts to lower frequency with added particles as expected.

### Frequency Response

- 1 In the **Home** toolbar, click  **Add Plot Group** and choose **ID Plot Group**.
- 2 In the **Settings** window for **ID Plot Group**, type Frequency Response in the **Label** text field.
- 3 Locate the **Data** section. From the **Dataset** list, choose **Study 2 - Frequency response/ Parametric Solutions 1 (sol3)**.
- 4 Locate the **Title** section. From the **Title type** list, choose **Label**.
- 5 Locate the **Legend** section. From the **Position** list, choose **Upper middle**.

Global 1

- 1 Right-click **Frequency Response** and choose **Global**.
- 2 In the **Settings** window for **Global**, locate the **y-Axis Data** section.
- 3 In the table, enter the following settings:

Expression	Unit	Description
$\log_{10}(\text{abs}(1/\text{es.Y11})/1[\text{ohm}])$		$\log_{10} Z $ (Ohms)

- 4 In the **Frequency Response** toolbar, click  **Plot**.

