

Surface Acoustic Wave Gas Sensor

Introduction

A surface acoustic wave (SAW) is an acoustic wave propagating along the surface of a solid material. Its amplitude decays rapidly, often exponentially, with the depth of the material. SAWs are featured in many kinds of electronic components, including filters, oscillators, and sensors. SAW devices typically use electrodes on a piezoelectric material to convert an electric signal to a SAW, and back again.

In this model, you investigate the resonance frequencies of a SAW gas sensor. The sensor consists of an interdigitated transducer (IDT) etched onto a piezoelectric LiNbO_3 (lithium niobate) substrate and covered with a thin polyisobutylene (PIB) film. The mass of the PIB film increases as PIB selectively adsorbs CH_2Cl_2 (dichloromethane, DCM) from air. This causes a shift in resonance which slightly lowers the resonance frequency for the same SAW mode.

Model Definition

Figure 1 shows a conceptual view of the gas sensor in this model.

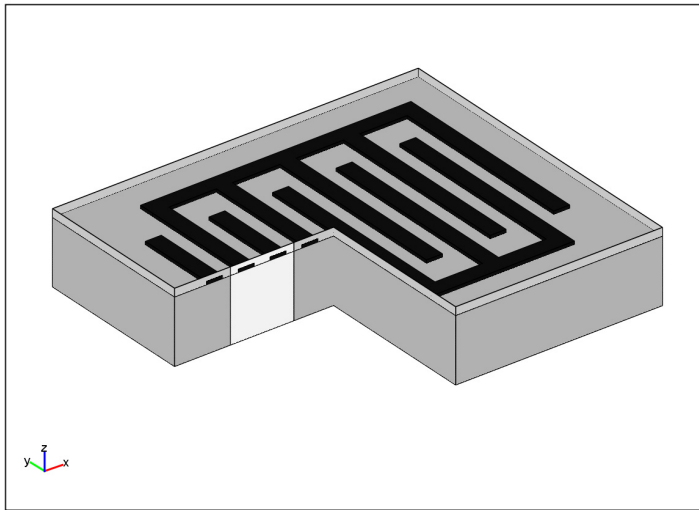

Figure 1: SAW gas sensor, showing the IDT electrodes (in black), the thin PIB film (light gray), and the LiNbO_3 substrate (dark gray). For the sake of clarity, the dimensions are not to scale and the IDT has fewer electrodes than in common devices. A slice of the geometry is removed to reveal the modeled unit cell (in white).

IDTs used in SAW devices may have hundreds of identical electrodes, and each electrode can be about 100 times longer than it is wide. You can therefore neglect the edge effects and reduce the model geometry to the periodic unit cell shown in [Figure 2](#). The height of this cell does not have to extend all the way to the bottom of the substrate but only a few wavelengths down, so that the SAW has almost died out at the lower boundary.

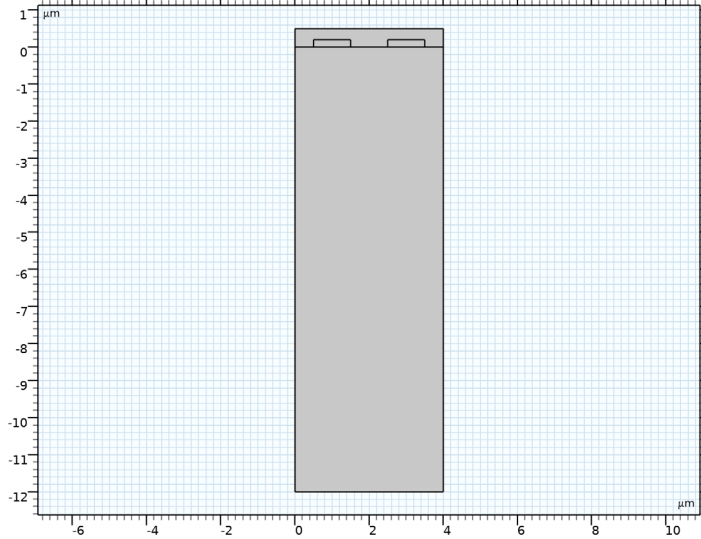

Figure 2: The geometry of the SAW unit cell used in this model. A 500 nm PIB film covers two 1 μm -wide electrodes on top of the LiNbO_3 substrate. The substrate domain has a total height of 12 μm .

Set up the model using the predefined Piezoelectricity multiphysics interface. In 2D, a Plane Strain assumption is used for the Solid Mechanics interface. Hence the out-of-plane strain component is zero. This should be a valid assumption, considering that the SAW is generated in the plane of the model and hence any variation in the out-of-plane direction can be considered minimal.

BOUNDARY CONDITIONS

In order to define the model, you need to apply structural and electrical boundary conditions.

As you can assume that the surface wave dies off within two to three wavelengths from the surface, the lower boundary is fixed in the model. This enforces a zero structural displacement but does not contribute to any significant reflection from the lower boundary back into the bulk of the substrate as long as we are observing surface waves and in particular Rayleigh waves.

The electrodes have a much higher electrical conductivity compared to PIB and LiNbO_3 . Hence, one can expect each of the electrodes to be isopotential. This is why you do not need to model the domains that constitute the electrodes but can simply use appropriate boundary conditions on all the outer boundaries of each electrode to indicate what type of isopotential state it is in. The boundaries of the left terminal is set to electrical ground, and those of the right terminal are assigned to a Floating Potential with zero surface charge accumulation. This combination of electrical boundary conditions corresponds to an open circuit configuration, which is typically suitable for sensing applications.

Use periodic boundary conditions to make the electric potential and displacements are the same along both vertical boundaries of the geometry. When using periodic boundary conditions, you need to ensure that the mesh on the vertical boundaries on the left of the unit cell and the vertical boundaries on the right of the unit cell are identical. This is achieved by first creating the mesh on the vertical boundaries on the left and then using the Copy Edge feature to create the exact same mesh on the vertical boundaries on the right.

All other boundaries are left to the default boundary conditions, which are Free for the Solid Mechanics interface and Zero Charge for the Electrostatics interface, respectively.

MATERIAL PROPERTIES

The substrate used in the simulation is YZ-cut LiNbO_3 with the following properties (cited in [Ref. 2](#)):

- *Elasticity matrix:*

$$\begin{bmatrix} 2.424\text{e}11 & 0.752\text{e}11 & 0.752\text{e}11 & 0 & 0 & 0 \\ & 2.03\text{e}11 & 0.573\text{e}11 & 0 & 0.085\text{e}11 & 0 \\ & & 2.03\text{e}11 & 0 & -0.085\text{e}11 & 0 \\ & & & 0.752\text{e}11 & 0 & 0.085\text{e}11 \\ & & & & 0.595\text{e}11 & 0 \\ & & & & & 0.595\text{e}11 \end{bmatrix}$$

- *Coupling matrix:*

$$\begin{bmatrix} 1.33 & 0.23 & 0.23 & 0 & 0 & 0 \\ 0 & 0 & 0 & -2.5 & 0 & 3.7 \\ 0 & -2.5 & 2.5 & 0 & 3.7 & 0 \end{bmatrix}$$

- *Relative permittivity:*

$$\begin{bmatrix} 28.7 & 0 & 0 \\ & 85.2 & 0 \\ & & 85.2 \end{bmatrix}$$

The density of the PIB film is from [Ref. 1](#). The Poisson's ratio is considered to be 0.48, and the Young's modulus is set to 10 GPa

The adsorption of DCM gas is represented as a slight increase of the overall density of the PIB film as shown in the following expression.

$$\rho = \rho_{PIB} + \text{switch} \cdot \rho_{DCM,PIB}$$

In this model, you use a parameter, *switch*, whose value can be either 0 or 1. This allows to solve the model for two cases; once without the effect of adsorbed gas and once with the effect of the adsorbed DCM gas in PIB.

When the sensor is exposed to 100 ppm of DCM in air at atmospheric pressure and room temperature, the "partial density" of DCM in the PIB film can be calculated from

$$\rho_{DCM,PIB} = KMc$$

where $K = 10^{1.4821}$ ([Ref. 1](#)) is the air/PIB partition coefficient for DCM, M is its molar mass, and c

$$c = (c_0 p) / (RT)$$

is its concentration in air. The DCM concentration, c in moles/m³ is computed using the Gas Law. Here c_0 is the concentration in parts per million, p is the pressure, T is the temperature, and R is the gas constant. Any effects of the DCM adsorption on the material properties other than the density are neglected.

Most of the material properties and factors affecting them have been parameterized as shown in Table 1. This easily allows the model to be adapted for other materials and operating conditions.

TABLE 1: LIST OF PARAMETERS.

NAME	EXPRESSION	DESCRIPTION
p	1[atm]	Air pressure
T	25[degC]	Air temperature
c0	100	DCM concentration in ppm
c_DCM_air	$10^{-6} * c0 * p / (R_const * T)$	DCM concentration in air
M_DCM	84.93[g/mol]	Molar mass of DCM
K	$10^{1.4821}$	PIB/air partition constant for DCM
rho_DCM_PIB	$K * M_DCM * c_DCM_air$	Mass concentration of DCM in PIB
rho_PIB	0.918[g/cm ³]	Density of PIB
E_PIB	10[GPa]	Young's modulus of PIB
nu_PIB	0.48	Poisson's ratio of PIB
eps_PIB	2.2	Relative permittivity of PIB
switch	0	Switch for adding DCM density
vR	3488[m/s]	Rayleigh wave velocity
width	4[um]	Width of unit cell
f0	vR/width	Estimated SAW frequency
t_PIB	0.5[um]	PIB thickness

ESTIMATING THE SAW FREQUENCY

The use of periodic boundary condition implies that the frequencies of interest correspond to wavelengths that are integer fractions of the width of the geometry. The lowest SAW eigenmode has its wavelength equal to the width of the geometry, that is, 4 μm . Using this along with the Rayleigh wave velocity for the given piezoelectric substrate material, one can find an estimate of the resonance frequency of interest. The information can be used in the eigenfrequency solver, which helps it to find out the resonance frequencies close to this estimated number. In this model, you use a YZ-cut LiNbO_3 whose Rayleigh wave velocity (vR) is around 3488 m/s. This gives an estimate of the lowest SAW frequency (f0) to be 872 MHz.

Results and Discussion

The first and second eigenfrequencies evaluate to approximately 850 MHz and 855 MHz, respectively. [Figure 3](#) and [Figure 4](#) show the corresponding SAW modes. [Figure 5](#) and [Figure 6](#) show the electric potential distribution characteristics for these solutions.

Exposing the sensor to a 100 ppm concentration of DCM in air leads to a resonance frequency shift of approximately 200 Hz downward. This shift is computed by evaluating the resonance frequency before and after adding the density of adsorbed DCM to that of the PIB domain.

Note that the computational mesh is identical in both these solutions. This implies that the relative error of the frequency shift is similar to that of the resonance frequency itself. Thus, the shift is accurately evaluated despite being a few magnitudes smaller than the absolute error of the resonance frequency.

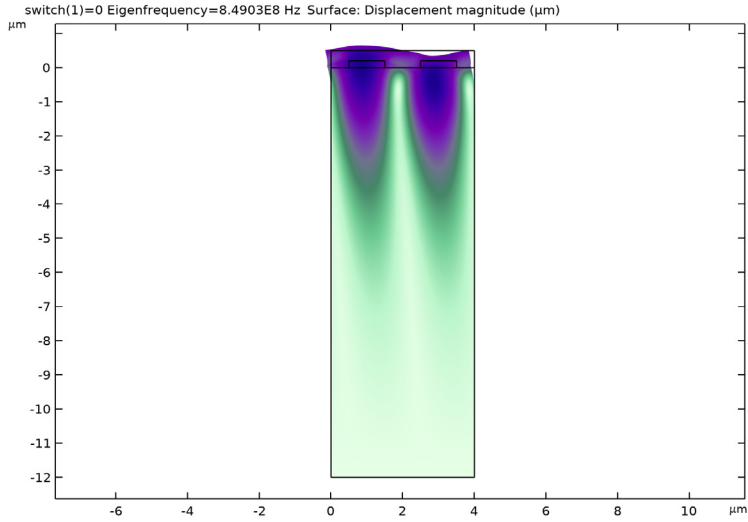

Figure 3: Deformed shape plot of the first SAW mode.

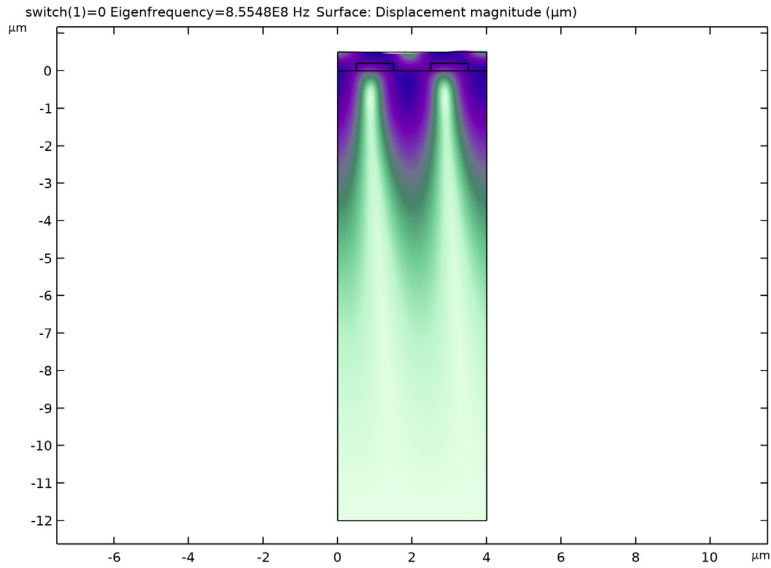

Figure 4: Deformed shape plot of the second SAW mode.

switch(1)=0 Eigenfrequency=8.4903E8 Hz Surface: Electric potential (V)

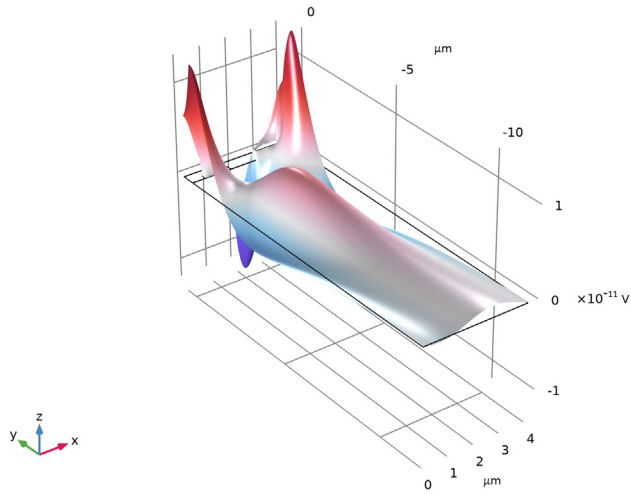

Figure 5: Electric potential distribution and deformations at first resonance, antisymmetric with respect to the center of each electrode.

switch(1)=0 Eigenfrequency=8.5548E8 Hz Surface: Electric potential (V)

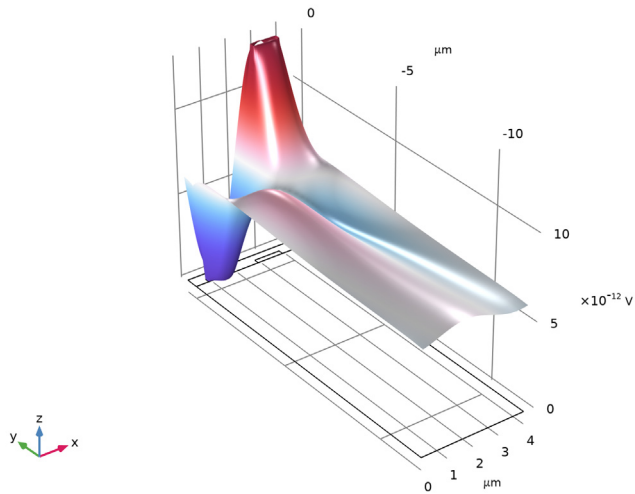

Figure 6: Electric potential distribution at second resonance, symmetric with respect to the center of each electrode.

References

1. K. Ho, E.R. Lindgren, K.S. Rawlinson, L.K. McGrath, and J. L. Wright, “Development of a Surface Acoustic Wave Sensor for In-Situ Monitoring of Volatile Organic Compounds,” *Sensors* vol. 3, pp. 236–247, 2003.
2. S. Ahmadi, F. Hassani, C. Korman, M. Rahaman, and M. Zaghoul, “Characterization of Multi- and Single-layer Structure SAW Sensor,” *Sensors 2004, Proceedings of IEEE*, vol. 3, pp. 1129–1132, 2004.

Application Library path: MEMS_Module/Sensors/saw_gas_sensor



Modeling Instructions

From the **File** menu, choose **New**.

NEW

In the **New** window, click  **Model Wizard**.

MODEL WIZARD

- 1 In the **Model Wizard** window, click  **2D**.
- 2 In the **Select Physics** tree, select **Structural Mechanics>Electromagnetics-Structure Interaction>Piezoelectricity>Piezoelectricity, Solid**.
- 3 Click **Add**.
- 4 Click  **Study**.
- 5 In the **Select Study** tree, select **Preset Studies for Selected Multiphysics>Eigenfrequency**.
- 6 Click  **Done**.

GEOMETRY I

For quicker modeling, load the parameters from a file.

GLOBAL DEFINITIONS

Parameters I

- 1 In the **Model Builder** window, under **Global Definitions** click **Parameters I**.
- 2 In the **Settings** window for **Parameters**, locate the **Parameters** section.

- 3 Click  **Load from File**.
- 4 Browse to the model's Application Libraries folder and double-click the file `saw_gas_sensor_parameters.txt`.

GEOMETRY 1

- 1 In the **Model Builder** window, under **Component 1 (comp1)** click **Geometry 1**.
- 2 In the **Settings** window for **Geometry**, locate the **Units** section.
- 3 From the **Length unit** list, choose μm .



Rectangle 1 (r1)

- 1 In the **Geometry** toolbar, click  **Rectangle**.
- 2 In the **Settings** window for **Rectangle**, locate the **Size and Shape** section.
- 3 In the **Width** text field, type `width`.
- 4 In the **Height** text field, type `3*width+t_PIB`.
- 5 Locate the **Position** section. In the **y** text field, type `-3*width`.
- 6 Click to expand the **Layers** section. In the table, enter the following settings:

Layer name	Thickness (μm)
Layer 1	t_PIB

- 7 Select the **Layers on top** check box.
- 8 Clear the **Layers on bottom** check box.
- 9 Click  **Build Selected**.

Rectangle 2 (r2)

- 1 In the **Geometry** toolbar, click  **Rectangle**.
- 2 In the **Settings** window for **Rectangle**, locate the **Size and Shape** section.
- 3 In the **Width** text field, type `width/4`.
- 4 In the **Height** text field, type `0.4*t_PIB`.
- 5 Locate the **Position** section. In the **x** text field, type `width/8`.
- 6 Click  **Build Selected**.

Copy 1 (copy1)

- 1 In the **Geometry** toolbar, click  **Transforms** and choose **Copy**.
- 2 Select the object **r2** only.
- 3 In the **Settings** window for **Copy**, locate the **Displacement** section.

4 In the **x** text field, type $\text{width}/2$.

5 Click  **Build All Objects**.

Before creating materials, define the domains where each physics apply.

SOLID MECHANICS (SOLID)

Piezoelectric Material 1

1 In the **Model Builder** window, under **Component 1 (comp1)**>**Solid Mechanics (solid)** click **Piezoelectric Material 1**.

2 In the **Settings** window for **Piezoelectric Material**, locate the **Domain Selection** section.

3 Click  **Clear Selection**.

4 Select Domain 1 only.

ELECTROSTATICS (ES)

The electrical equations are not solved in the aluminum electrodes because they are assumed to be perfect conductors compared to LiNbO₃ and PIB, and hence we consider them to be equipotential regions.

1 In the **Model Builder** window, under **Component 1 (comp1)** click **Electrostatics (es)**.

2 Select Domains 1 and 2 only.

Charge Conservation, Piezoelectric 1

1 In the **Model Builder** window, under **Component 1 (comp1)**>**Electrostatics (es)** click **Charge Conservation, Piezoelectric 1**.

2 Select Domain 1 only.

MATERIALS

LiNbO₃

1 In the **Model Builder** window, under **Component 1 (comp1)** right-click **Materials** and choose **Blank Material**.

2 In the **Settings** window for **Material**, type LiNbO₃ in the **Label** text field.

3 Locate the **Geometric Entity Selection** section. Click  **Clear Selection**.

4 Select Domain 1 only.

5 Locate the **Material Contents** section. In the table, enter the following settings:

Property	Variable	Value	Unit	Property group
Elasticity matrix, Voigt notation	{cE11, cE12, cE22, cE13, cE23, cE33, cE14, cE24, cE34, cE44, cE15, cE25, cE35, cE45, cE55, cE16, cE26, cE36, cE46, cE56, cE66} ; cEij = cEji	{242.4[GPa], 75.2[GPa], 203[GPa], 75.2[GPa], 57.3[GPa], 203[GPa], 0, 0, 0, 75.2[GPa], 0, 8.5[GPa], -8.5[GPa], 0, 59.5[GPa], 0, 0, 0, 8.5[GPa], 0, 59.5[GPa]}	Pa	Stress-charge form
Coupling matrix, Voigt notation	{eES11, eES21, eES31, eES12, eES22, eES32, eES13, eES23, eES33, eES14, eES24, eES34, eES15, eES25, eES35, eES16, eES26, eES36}	{1.33, 0, 0, 0.23, 0, -2.5, 0.23, 0, 2.5, 0, -2.5, 0, 0, 0, 3.7, 0, 3.7, 0}	C/m ²	Stress-charge form
Relative permittivity	{epsilonNrS11, epsilonNrS22, epsilonNrS33} ; epsilonNrSij = 0	{28.7, 85.2, 85.2}	l	Stress-charge form
Density	rho	4647	kg/m ³	Basic

Alternately, you can click the **Edit** button below the **Output properties** table and use the matrix inputs to enter cE, e, and epsilonNrS according to the material data shown under the **Model Definition** section.



PIB

- 1 Right-click **Materials** and choose **Blank Material**.
- 2 In the **Settings** window for **Material**, type PIB in the **Label** text field.
- 3 Select Domain 2 only.

4 Locate the **Material Contents** section. In the table, enter the following settings:

Property	Variable	Value	Unit	Property group
Young's modulus	E	E_PIB	Pa	Young's modulus and Poisson's ratio
Poisson's ratio	nu	nu_PIB	l	Young's modulus and Poisson's ratio
Density	rho	rho_PIB+switch* rho_DCM_PIB	kg/m ³	Basic
Relative permittivity	epsilon _{r_1} ; epsilon _{r_2} = epsilon _{r_1} , epsilon _{r_3} = 0	eps_PIB	l	Basic

ADD MATERIAL

- 1 In the **Home** toolbar, click  **Add Material** to open the **Add Material** window.
- 2 Go to the **Add Material** window.
- 3 In the tree, select **Built-in>Aluminum**.
- 4 Click **Add to Component** in the window toolbar.
- 5 In the **Home** toolbar, click  **Add Material** to close the **Add Material** window.

MATERIALS

Aluminum (mat3)

Select Domains 3 and 4 only.

SOLID MECHANICS (SOLID)

In the **Model Builder** window, under **Component 1 (comp1)** click **Solid Mechanics (solid)**.

Fixed Constraint 1

- 1 In the **Physics** toolbar, click  **Boundaries** and choose **Fixed Constraint**.
- 2 Select Boundary 2 only.

Periodic Condition 1

- 1 In the **Physics** toolbar, click  **Boundaries** and choose **Periodic Condition**.

2 Select Boundaries 1, 3, 16, and 17 only.

This defines periodic condition for the **Solid Mechanics** physics. By default, the periodicity type is set to **Continuity** for all dependent variables.

ELECTROSTATICS (ES)

Ground the left electrode by applying boundary condition on its edges.

1 In the **Model Builder** window, under **Component 1 (comp1)** click **Electrostatics (es)**.

Ground 1

1 In the **Physics** toolbar, click  **Boundaries** and choose **Ground**.

2 Select Boundaries 6–9 only.

Apply a **Floating Potential** on the edges of the right electrode.

Floating Potential 1

1 In the **Physics** toolbar, click  **Boundaries** and choose **Floating Potential**.

2 Select Boundaries 11–14 only.

Define periodic boundary condition for the **Electrostatics** physics.

Periodic Condition 1

1 In the **Physics** toolbar, click  **Boundaries** and choose **Periodic Condition**.

2 Select Boundaries 1, 3, 16, and 17 only.

MESH 1

Edge 1

1 In the **Mesh** toolbar, click  **Edge**.

2 Select Boundaries 1 and 3 only.

Distribution 1

1 Right-click **Edge 1** and choose **Distribution**.

2 Select Boundary 3 only.

3 In the **Settings** window for **Distribution**, locate the **Distribution** section.

4 In the **Number of elements** text field, type 4.

Edge 1

Define an increasing mesh size along the thickness of the piezoelectric substrate.

Distribution 2

1 In the **Model Builder** window, right-click **Edge 1** and choose **Distribution**.

- 2 Select Boundary 1 only.
- 3 In the **Settings** window for **Distribution**, locate the **Distribution** section.
- 4 From the **Distribution type** list, choose **Predefined**.
- 5 In the **Number of elements** text field, type 25.
- 6 In the **Element ratio** text field, type 25.
- 7 Select the **Reverse direction** check box.
- 8 Click  **Build Selected**.

Copy Edge 1

- 1 In the **Model Builder** window, right-click **Mesh 1** and choose **Copying Operations> Copy Edge**.
- 2 Select Boundaries 1 and 3 only.
- 3 In the **Settings** window for **Copy Edge**, locate the **Destination Boundaries** section.
- 4 Click to select the  **Activate Selection** toggle button.
- 5 Select Boundaries 16 and 17 only.

Free Quad 1

- 1 In the **Mesh** toolbar, click  **Free Quad**.
- 2 In the **Settings** window for **Free Quad**, locate the **Domain Selection** section.
- 3 From the **Geometric entity level** list, choose **Domain**.
- 4 Select Domains 2–4 only.

Size 1

- 1 Right-click **Free Quad 1** and choose **Size**.
- 2 In the **Settings** window for **Size**, locate the **Element Size** section.
- 3 Click the **Custom** button.
- 4 Locate the **Element Size Parameters** section.
- 5 Select the **Maximum element size** check box. In the associated text field, type $t_PIB/4$.

Mapped 1

- 1 In the **Mesh** toolbar, click  **Mapped**.

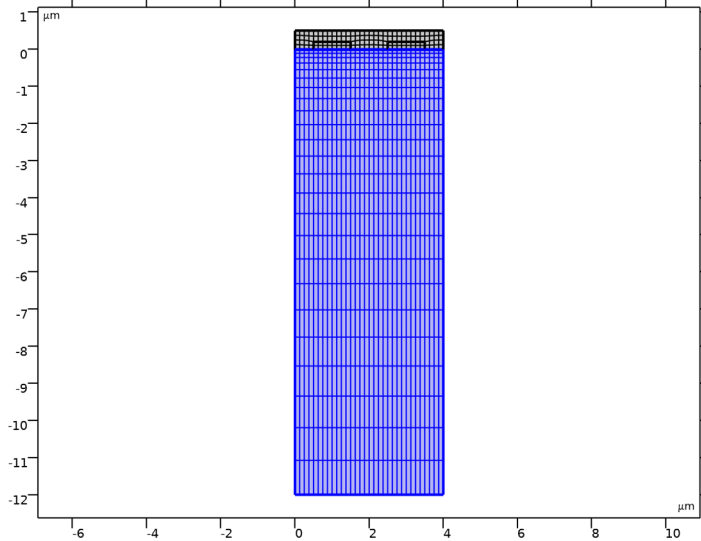

2 In the **Settings** window for **Mapped**, click  **Build All**.



STUDY 1

Set up a **Parametric Sweep** to solve the model with and without the adsorbed species on the sensor. The parameter switch is used to solve the model once without adding the density of DCM and once with the added density of adsorbed DCM in PIB.

Parametric Sweep

- 1 In the **Study** toolbar, click  **Parametric Sweep**.
- 2 In the **Settings** window for **Parametric Sweep**, locate the **Study Settings** section.
- 3 Click  **Add**.
- 4 In the table, enter the following settings:

Parameter name	Parameter value list	Parameter unit
switch (Switch for adding DCM density)	0 1	

Search for eigenfrequencies near the estimated resonance frequency.

Step 1: Eigenfrequency

- 1 In the **Model Builder** window, click **Step 1: Eigenfrequency**.
- 2 In the **Settings** window for **Eigenfrequency**, locate the **Study Settings** section.
- 3 In the **Search for eigenfrequencies around** text field, type f_0 .

- 4 In the **Study** toolbar, click  **Compute**.

RESULTS



Mode Shape (solid)

The default plot shows the anti-resonance SAW mode near 850 MHz. Adjust the deformed shape plot to see the effect of the wave localization near the surface.

- 1 In the **Settings** window for **2D Plot Group**, locate the **Data** section.
- 2 From the **Parameter value (switch)** list, choose **0**.
- 3 In the **Model Builder** window, expand the **Mode Shape (solid)** node.

Deformation

- 1 In the **Model Builder** window, expand the **Results>Mode Shape (solid)>Surface 1** node, then click **Deformation**.
- 2 In the **Settings** window for **Deformation**, locate the **Scale** section.
- 3 Select the **Scale factor** check box. In the associated text field, type $5e13$.



- 4 In the **Mode Shape (solid)** toolbar, click  **Plot**.
- 5 Click the  **Zoom Extents** button in the **Graphics** toolbar.

Compare the resulting plot to that in [Figure 3](#).

Plot the second mode shape near 855 MHz, which is the resonance SAW mode.

- 6 In the **Mode Shape (solid)** toolbar, click  **Plot**.

Mode Shape (solid)

- 1 In the **Model Builder** window, under **Results** click **Mode Shape (solid)**.
- 2 In the **Settings** window for **2D Plot Group**, locate the **Data** section.
- 3 From the **Eigenfrequency (Hz)** list, choose **8.5548E8**.
- 4 In the **Mode Shape (solid)** toolbar, click  **Plot**.
- 5 Click the  **Zoom Extents** button in the **Graphics** toolbar.

Compare the resulting plot to that in [Figure 4](#).

Electric Potential (es)

To visualize the electric potential distribution for the eigenmodes, follow these steps.

Surface 1

- 1 In the **Model Builder** window, expand the **Results>Electric Potential (es)** node, then click **Surface 1**.
- 2 In the **Settings** window for **Surface**, locate the **Coloring and Style** section.

- 3 Click  **Change Color Table**.
- 4 In the **Color Table** dialog box, select **Wave>WaveLight** in the tree.
- 5 Click **OK**.





Height Expression 1

Right-click **Surface 1** and choose **Height Expression**.

Streamline 1



In the **Model Builder** window, under **Results>Electric Potential (es)** right-click **Streamline 1** and choose **Disable**.

Electric Potential (es)

- 1 In the **Model Builder** window, click **Electric Potential (es)**.
- 2 In the **Settings** window for **2D Plot Group**, locate the **Color Legend** section.
- 3 Clear the **Show legends** check box.
- 4 Locate the **Data** section. From the **Parameter value (switch)** list, choose **0**.
- 5 In the **Electric Potential (es)** toolbar, click  **Plot**.
- 6 Click the  **Zoom Extents** button in the **Graphics** toolbar.
- 7 From the **Eigenfrequency (Hz)** list, choose **8.5548E8**.
- 8 In the **Electric Potential (es)** toolbar, click  **Plot**.
- 9 Click the  **Zoom Extents** button in the **Graphics** toolbar.

To see all computed eigenfrequencies as a table, follow these steps.

Global Evaluation 1

- 1 In the **Results** toolbar, click  **Global Evaluation**.
- 2 In the **Settings** window for **Global Evaluation**, locate the **Data** section.
- 3 From the **Dataset** list, choose **Study 1/Parametric Solutions 1 (sol2)**.
- 4 From the **Table columns** list, choose **Outer solutions**.
- 5 Click **Replace Expression** in the upper-right corner of the **Expressions** section. From the menu, choose **Solver>freq - Frequency - Hz**.
- 6 Click  next to  **Evaluate**, then choose **New Table**.

TABLE

- 1 Go to the **Table** window.

2 Click **Full Precision** in the window toolbar.

The first 6 digits of the eigenfrequency are the same. Subtracting the new value from the previous value shows that the eigenfrequency with gas exposure is lower by 200 Hz.