



# Electric Shielding

## *Introduction*

---

This is a tutorial application that shows how to model isolated highly conductive objects in the Electric Currents interface. The analysis includes the current terminal and electric shielding boundary conditions.

## *Model Definition*

---

The modeling domain is a seawater filled box containing an electrode. The sides of the box are insulated while the top has an assigned electric potential of 1 V and the bottom is set to ground.

### **BOUNDARY CONDITIONS ON THE ELECTRODE**

The first version of the application uses the terminal boundary condition with a zero net current. The electrode then assumes a constant potential determined by the surrounding field. This condition, also known as a floating potential condition, can be a good approximation if the electrode is a much better conductor than the surrounding medium. It can also be used for metal surfaces in electrostatics, where the zero current condition is replaced by a zero total charge.

The second version uses an electric shielding condition instead of the terminal boundary condition. The electric shielding condition requires the specification of the material constituting the thin layer and its thickness. When used for describing thin sheets of conducting materials, the electric shielding condition results in a potential that is assumed to be constant across the depth of the material, but varies on its surface.

## *Results and Discussion*

---

[Figure 1](#) shows the potential distribution when using the electric shielding condition. The electrode is modeled as a 1 mm thick sheet of titanium bent to form three quarters of a cylinder. The cylinder has a radius of 0.2 m and is centered in a cube with a 1 m side. The

result, as seen in the surface plot, is a potential that varies between 0.472 V and 0.476 V on the conductor.

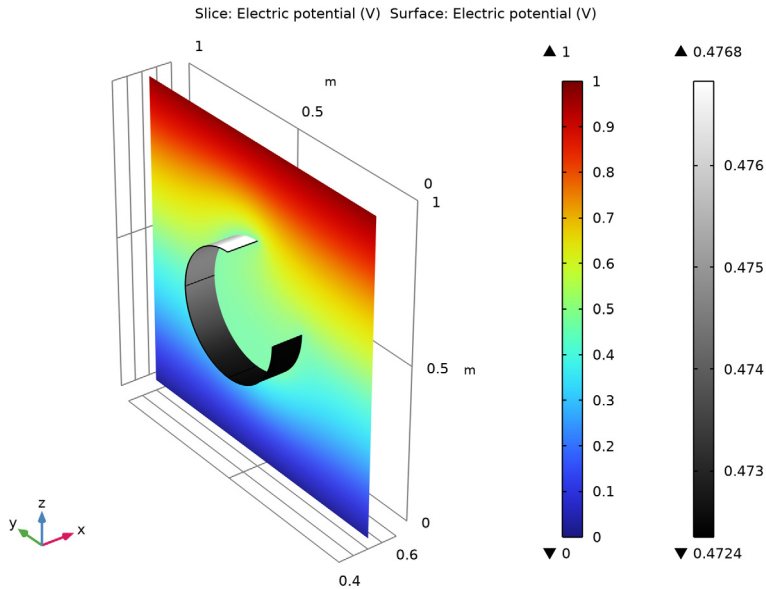

Figure 1: The electric potential distribution on the conductor and in the water when using the electric shielding condition.

For a comparison, with the zero current terminal condition, the potential on the conductor evaluates to a constant 0.474 V.

---

**Application Library path:** ACDC\_Module/Introductory\_Electric\_Currents/  
electric\_shielding

---

### *Modeling Instructions*



---

From the **File** menu, choose **New**.

#### **NEW**

In the **New** window, click  **Model Wizard**.



## MODEL WIZARD

- 1 In the **Model Wizard** window, click  **3D**.
- 2 In the **Select Physics** tree, select **AC/DC>Electric Fields and Currents>Electric Currents (ec)**.
- 3 Click **Add**.
- 4 Click  **Study**.
- 5 In the **Select Study** tree, select **General Studies>Stationary**.
- 6 Click  **Done**.

## GEOMETRY I

Create the model geometry, starting with the electrode.

### *Cylinder 1 (cyl1)*

- 1 In the **Geometry** toolbar, click  **Cylinder**.
- 2 In the **Settings** window for **Cylinder**, locate the **Object Type** section.
- 3 From the **Type** list, choose **Surface**.
- 4 Locate the **Size and Shape** section. In the **Radius** text field, type 0.2.
- 5 In the **Height** text field, type 0.2.
- 6 Locate the **Position** section. In the **x** text field, type 0.4.
- 7 In the **y** text field, type 0.5.
- 8 In the **z** text field, type 0.5.
- 9 Locate the **Axis** section. From the **Axis type** list, choose **Cartesian**.
- 10 In the **x** text field, type 1.
- 11 In the **z** text field, type 0.
- 12 Click  **Build Selected**.

Next, delete the segment of the cylinder that lies in the octant  $y \leq 0, z \geq 0$ .

### *Delete Entities 1 (dell)*

- 1 In the **Model Builder** window, right-click **Geometry I** and choose **Delete Entities**.

2 Select the boundary shown in the figure below by clicking on it.

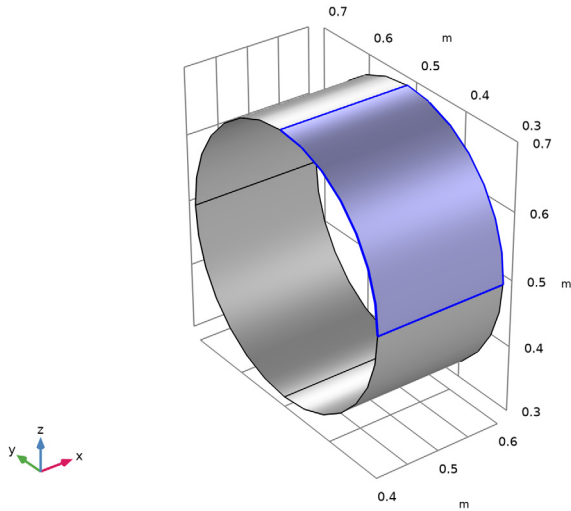

3 In the **Settings** window for **Delete Entities**, click  **Build Selected**.





In order to facilitate applying materials and boundary conditions, create a selection of the electrode object.

#### *Electrode*

- 1 In the **Geometry** toolbar, click  **Selections** and choose **Explicit Selection**.
- 2 In the **Settings** window for **Explicit Selection**, locate the **Entities to Select** section.
- 3 From the **Geometric entity level** list, choose **Boundary**.
- 4 In the **Graphics** window, click on the three boundaries constituting the electrode.
- 5 In the **Label** text field, type **Electrode**.

Finish the geometry by adding a block for the salt-water domain surrounding the electrode.



#### *Block 1 (blk1)*

- 1 In the **Geometry** toolbar, click  **Block**.
- 2 In the **Settings** window for **Block**, click  **Build All Objects**.
- 3 Click the  **Zoom Extents** button in the **Graphics** toolbar.
- 4 Click the  **Wireframe Rendering** button in the **Graphics** toolbar.

## MATERIALS

Having created the geometry, proceed to assign materials.

### ADD MATERIAL

- 1 In the **Home** toolbar, click  **Add Material** to open the **Add Material** window.
- 2 Go to the **Add Material** window.
- 3 In the tree, select **Built-in>Titanium beta-21S**.
- 4 Click **Add to Component** in the window toolbar.
- 5 In the **Home** toolbar, click  **Add Material** to close the **Add Material** window.

## MATERIALS

*Titanium beta-21S (mat1)*

- 1 In the **Settings** window for **Material**, locate the **Geometric Entity Selection** section.
- 2 From the **Geometric entity level** list, choose **Boundary**.
- 3 From the **Selection** list, choose **Electrode**.

*Sea Water*

- 1 In the **Model Builder** window, right-click **Materials** and choose **Blank Material**.
- 2 In the **Settings** window for **Material**, type Sea Water in the **Label** text field.
- 3 Select Domain 1 only.
- 4 Locate the **Material Contents** section. In the table, enter the following settings:

Property	Variable	Value	Unit	Property group
Electrical conductivity	sigma_iso ; sigma_ii = sigma_iso, sigma_ij = 0	5	S/m	Basic
Relative permittivity	epsilon_nr_iso ; epsilon_nrii = epsilon_nr_iso, epsilon_nrij = 0	85	1	Basic

## ELECTRIC CURRENTS (EC)

*Ground 1*

- 1 In the **Model Builder** window, under **Component 1 (comp1)** right-click **Electric Currents (ec)** and choose **Ground**.

2 Select Boundary 3 only.

#### *Electric Potential I*

- 1 In the **Physics** toolbar, click  **Boundaries** and choose **Electric Potential**.
- 2 Select Boundary 4 only.
- 3 In the **Settings** window for **Electric Potential**, locate the **Electric Potential** section.
- 4 In the  $V_0$  text field, type 1.

#### *Terminal I*

- 1 In the **Physics** toolbar, click  **Boundaries** and choose **Terminal**.
- 2 In the **Settings** window for **Terminal**, locate the **Boundary Selection** section.
- 3 From the **Selection** list, choose **Electrode**.

Next, apply an **Electric Shielding** node to the electrode for use in the second study. To prevent it from overriding the **Terminal** node just added, it will be excluded in the first study.

#### *Electric Shielding I*

- 1 In the **Physics** toolbar, click  **Boundaries** and choose **Electric Shielding**.
- 2 In the **Settings** window for **Electric Shielding**, locate the **Boundary Selection** section.
- 3 From the **Selection** list, choose **Electrode**.
- 4 Locate the **Thickness** section. In the  $d_s$  text field, type 1 [mm].

### **MESH I**

#### *Free Tetrahedral I*

In the **Mesh** toolbar, click  **Free Tetrahedral**.

#### *Size*



- 1 In the **Model Builder** window, click **Size**.
- 2 In the **Settings** window for **Size**, locate the **Element Size** section.
- 3 From the **Predefined** list, choose **Fine**.
- 4 Click  **Build All**.

### **STUDY I**

Before solving, disable the **Electric Shielding** node.

#### *Step 1: Stationary*

- 1 In the **Model Builder** window, under **Study I** click **Step 1: Stationary**.

- 2 In the **Settings** window for **Stationary**, locate the **Physics and Variables Selection** section.
- 3 Select the **Modify model configuration for study step** check box.
- 4 In the tree, select **Component 1 (comp1)>Electric Currents (ec)>Electric Shielding 1**.
- 5 Click  **Disable**.
- 6 In the tree, select **Component 1 (comp1)**.
- 7 In the **Model Builder** window, click **Study 1**.
- 8 In the **Settings** window for **Study**, locate the **Study Settings** section.
- 9 Clear the **Generate default plots** check box.  
This setting is useful if you want full control over which plot groups to create.
- 10 In the **Home** toolbar, click  **Compute**.

## RESULTS

Before adding a **3D Plot Group** to use for reproducing the plot in [Figure 1](#), add a selection to the solution dataset to hide the block obstructing the view of the electrode.

- 1 In the **Model Builder** window, expand the **Results** node.

*Study 1/Solution 1 (sol1)*

In the **Model Builder** window, expand the **Results>Datasets** node, then click **Study 1/Solution 1 (sol1)**.

*Selection*

- 1 In the **Results** toolbar, click  **Attributes** and choose **Selection**.
- 2 In the **Settings** window for **Selection**, locate the **Geometric Entity Selection** section.
- 3 From the **Geometric entity level** list, choose **Boundary**.
- 4 From the **Selection** list, choose **Electrode**.

Now create the plot.

*3D Plot Group 1*

- 1 In the **Results** toolbar, click  **3D Plot Group**.  
Change some settings in the color legends to better visualize the small variations in electric potential on the surface.
- 2 In the **Settings** window for **3D Plot Group**, locate the **Color Legend** section.
- 3 Select the **Show maximum and minimum values** check box.
- 4 Click to expand the **Number Format** section. Select the **Manual color legend settings** check box.



5 In the **Precision** text field, type 4.

#### *Slice 1*

- 1 Right-click **3D Plot Group 1** and choose **Slice**.
- 2 In the **Settings** window for **Slice**, locate the **Plane Data** section.
- 3 In the **Planes** text field, type 1.

#### *Surface 1*

- 1 In the **Model Builder** window, right-click **3D Plot Group 1** and choose **Surface**.
- 2 In the **Settings** window for **Surface**, locate the **Coloring and Style** section.
- 3 Click  **Change Color Table**.
- 4 In the **Color Table** dialog box, select **Linear>GrayScale** in the tree.
- 5 Click **OK**.

Note that the potential on the surface is constant.

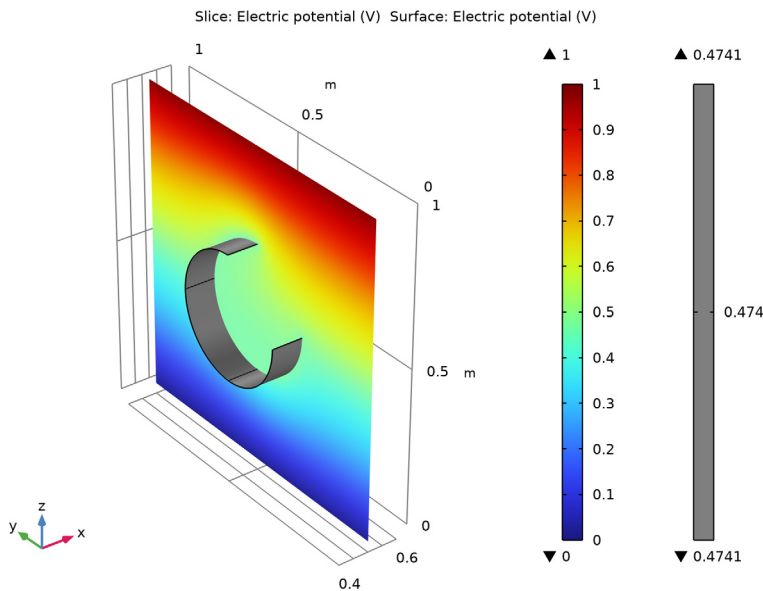

#### *3D Plot Group 1*

- 1 In the **Model Builder** window, click **3D Plot Group 1**.
- 2 In the **3D Plot Group 1** toolbar, click  **Plot**.



This concludes the work on the terminal version of this application. Next, investigate how the results change as you introduce a finite conductivity and thickness to the plate. Add a separate study for this analysis.



## ADD STUDY

- 1 In the **Home** toolbar, click  **Add Study** to open the **Add Study** window.
- 2 Go to the **Add Study** window.
- 3 Find the **Studies** subsection. In the **Select Study** tree, select **General Studies>Stationary**.
- 4 Click **Add Study** in the window toolbar.
- 5 In the **Home** toolbar, click  **Add Study** to close the **Add Study** window.

## STUDY 2

### *Step 1: Stationary*

Disable the **Terminal** node for this study, even though this is not strictly necessary as this node is overridden by the **Electric Shielding** node.

- 1 In the **Settings** window for **Stationary**, locate the **Physics and Variables Selection** section.
- 2 Select the **Modify model configuration for study step** check box.
- 3 In the tree, select **Component 1 (comp1)>Electric Currents (ec)>Terminal 1**.
- 4 Click  **Disable**.
- 5 In the tree, select **Component 1 (comp1)**.
- 6 In the **Model Builder** window, click **Study 2**.
- 7 In the **Settings** window for **Study**, locate the **Study Settings** section.
- 8 Clear the **Generate default plots** check box.
- 9 In the **Home** toolbar, click  **Compute**.

## RESULTS

Add a selection, restricting this solution dataset to the electrode as well.

### *Study 2/Solution 2 (sol2)*

In the **Model Builder** window, under **Results>Datasets** click **Study 2/Solution 2 (sol2)**.

### *Selection*

- 1 In the **Results** toolbar, click  **Attributes** and choose **Selection**.
- 2 In the **Settings** window for **Selection**, locate the **Geometric Entity Selection** section.
- 3 From the **Geometric entity level** list, choose **Boundary**.

- 4 From the **Selection** list, choose **Electrode**.

You may use the plot group you have already created as the starting point for plotting the new solution.

### *3D Plot Group 2*

- 1 In the **Model Builder** window, under **Results** right-click **3D Plot Group 1** and choose **Duplicate**.
- 2 In the **Settings** window for **3D Plot Group**, locate the **Data** section.
- 3 From the **Dataset** list, choose **Study 2/Solution 2 (sol2)**.
- 4 In the **3D Plot Group 2** toolbar, click  **Plot**.

The electric potential on the plate should now range from 0.472 V to 0.476 V.

