



Modeling a Capacitive Position Sensor Using FEM

Introduction

In this electrostatics tutorial model the capacitance matrix of a five-terminals sensor is computed and related to the position of a metallic test object. The model explains how to extract lumped matrices using the Stationary Source Sweep Study. Useful extra features of the Stationary Source Sweep Study, such as sweeping on a subset of the terminals are showcased. It is also discussed how the study's performance is affected when using direct and iterative solvers.

Model Definition

The model solves an electrostatic problem typical for the design of capacitive position sensors. A generic design consists of a ground plane (Figure 1), and a series of electrodes (Figure 2).

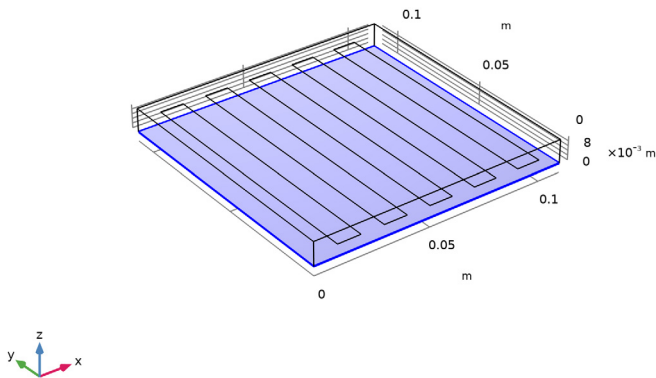

Figure 1: The ground plane of the sensor is highlighted.

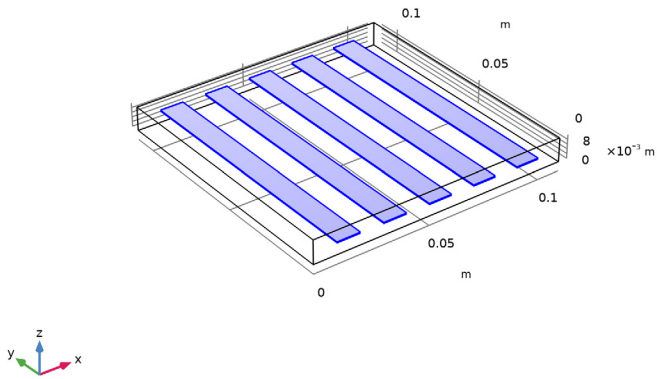

Figure 2: The five sensing electrodes are highlighted.

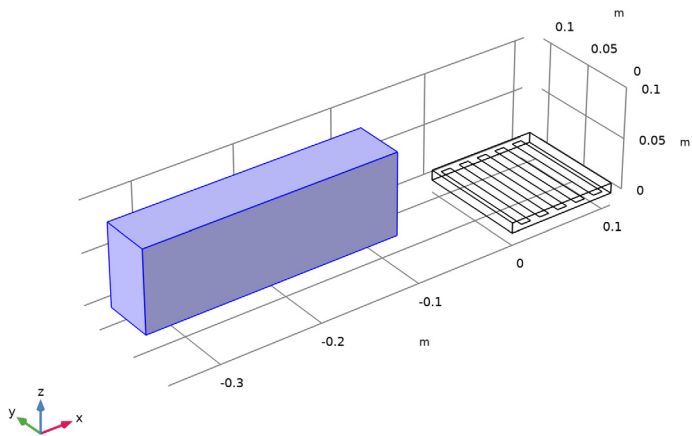

Figure 3: Test object when it is far from the sensor.

Any metallic object or object with dielectric contrast in the neighborhood of the sensor will change the capacitive coupling between the electrodes, including the ground electrode (Figure 3 and Figure 4).

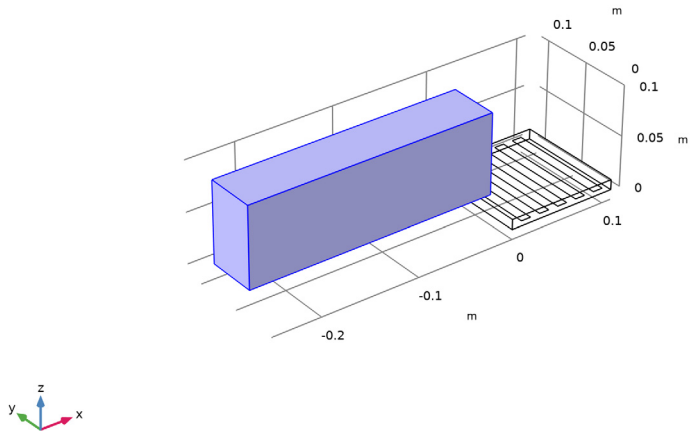

Figure 4: Test object when it is approaching the sensor.

This version of the model uses the finite element method. It requires adding a domain to model the air in between the sensor and the object and some of the surrounding air to capture fringing fields (see Figure 5). The dipole field surrounding the sensor falls off quickly with distance so it is possible to limit the computational domain to a high degree.

The related model [Modeling a Capacitive Position Sensor Using BEM](#) considers the case of the whole object in infinite space.

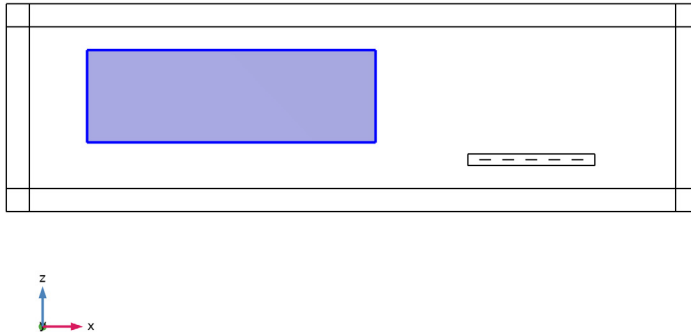

Figure 5: Truncation of the computational domain and test object.

In the Stationary Source Sweep study, COMSOL Multiphysics identifies all Terminal features in the model and excites them one at a time using a fixed charge excitation. The Terminals not excited are left at a floating potential (zero net charge).

The Stationary Source Sweep study generates default output nodes for three variants of the capacitance matrix: inverse Maxwell capacitance matrix (also known as the elastance matrix), Maxwell capacitance matrix, and the mutual capacitance matrix (also known as the SPICE capacitance matrix). For details, see the sections on Lumped Parameter Conversion and Stationary Source Sweep in the *AC/DC Module User's Guide*.

Depending on the electronics triggering the presence of the object, any of the three capacitance matrices may be the most relevant.

The surface of the metallic test object is modeled using domain Terminal condition with zero charge (floating electrode). It is shown how to exclude this extra Terminal from the sweep made at the study level.

The Stationary Source Sweep is optimized for solution speed. It works best with a direct solver as the LU decomposition has to be performed only once, followed by back substitution for the multiple source excitations (multiple right-hand sides). For 3D

models, the Stationary Source Sweep generates both an iterative and a direct solver. The former will be selected if the model is having a large number of elements, that is, above a built-in threshold. For hardware with sufficiently large RAM, it is recommended to manually switch to the direct solver.



A more advanced example on the extraction of capacitance is the Touchscreen Simulator in the AC/DC Module Application Library under the Applications section.

Results and Discussion

Figure 6 shows the default plot of the scaled Electric potential in absence of the test object when one of the lateral terminals is fed. The potential is zero at ground and the plot quantity is scaled to be unity at the excited terminal. In the step by step instructions, other similar plot are produced for the other terminals. While, one terminal is fed, the floating potential values of the non excited terminals are nonzero. These values represent measures of the off diagonal cross-capacitance couplings between different terminals.

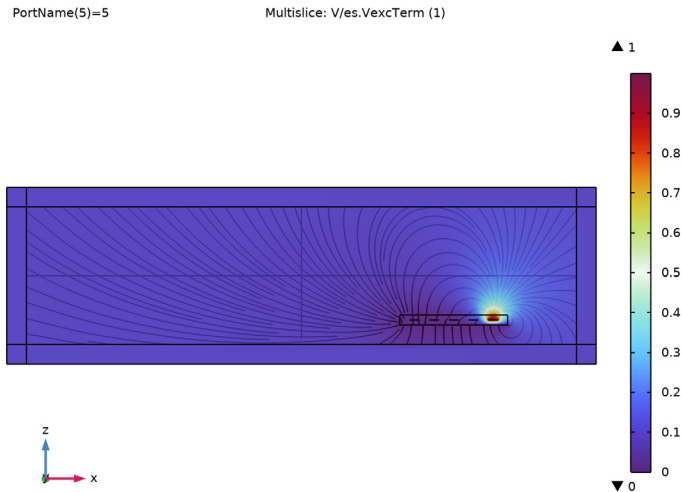

Figure 6: Electric potential in absence of the test object when one of the lateral terminals is fed.

The default matrix generation works by aggregating all data on all terminals and the results are presented in tables. Data in a table, can also be plotted, see [Figure 7](#).

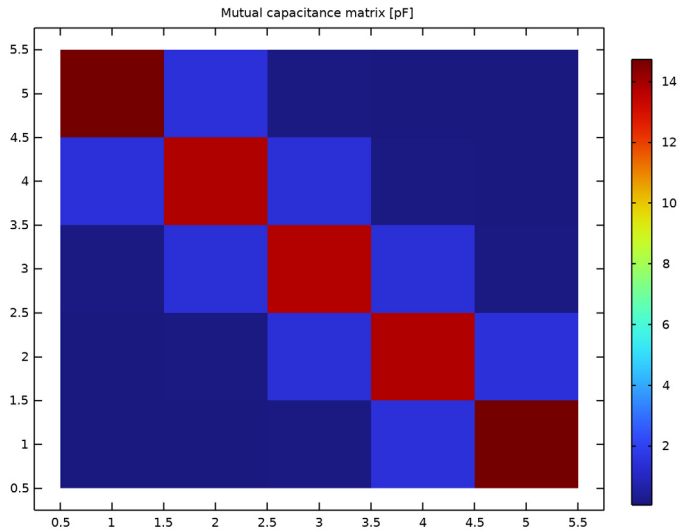

Figure 7: Mutual capacitance matrix displayed in a 2D plot.

The presence of the metallic test object influences the electric potential as can be clearly seen by comparing [Figure 8](#) and [Figure 9](#). [Figure 8](#) resembles [Figure 6](#) where the test object is absent. [Figure 9](#) shows how the electric potential drop, that is the electric field, is confined to a much more narrow region. This changes the accumulated surface charge on the conductors.

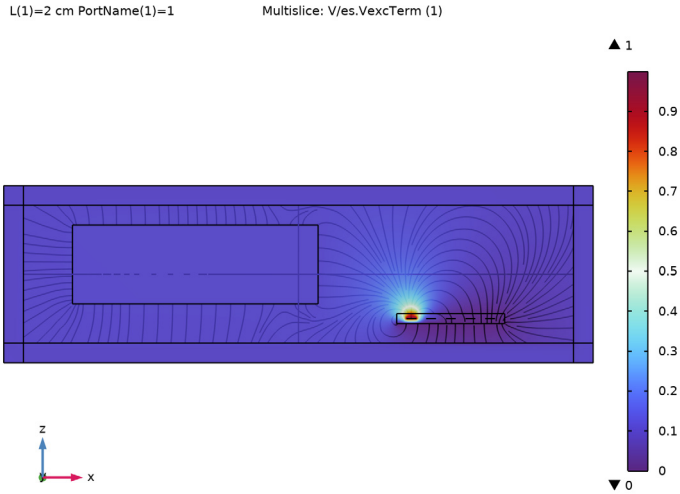

Figure 8: Electric potential in the presence of the test object in a position far from the sensor, when the nearest terminals is fed.

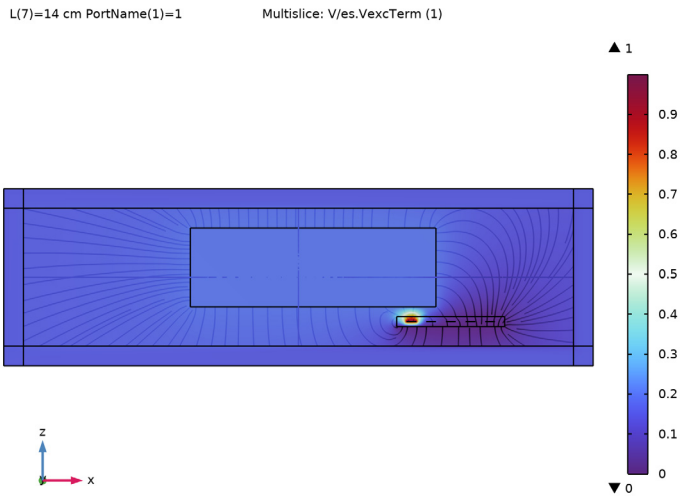

Figure 9: Electric potential in the presence of the test object in a position near the sensor, when the nearest terminals is fed.

A sensor is equipped with feeding circuitry that is designed to detect changes to the electrode to ground capacitance and/or interelectrode capacitances, thereby detecting the presence and position of an object. Many different combinations are possible. In [Figure 10](#), three evaluations of the change in capacitance are shown. The blue and green curves represent the change in inverse self capacitance of the most near and the most far electrode as a function of the position of the test object. Both electrodes change their absolute capacitances by about 2% when the object is approaching their positions. The most near sensor start sensing a change at a position of $L = 0.1$ m while the other start sensing the change when $L = 0.15$ m. The absolute capacitance of an electrode can slowly drift, for example because of water absorption in the dielectric. For this reason, it is more interesting to detect the presence of the object by means of relative changes in interelectrode capacitance values. The relative change in elastance of the first versus the last electrode is reported as the red curve in [Figure 10](#). It is clear that the test object produces a change in response of the nearest electrode with respect to the farthest one. This can trigger properly designed feeding circuitry detecting the presence of the object.

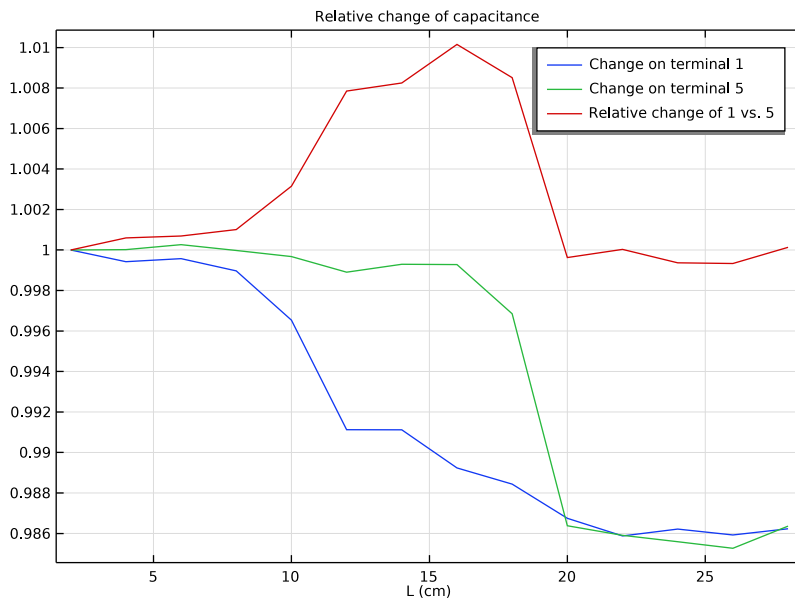



Figure 10: Change in inverse capacitance (elastance) as function of position of the incoming metal object. Blue and green line are respectively the absolute change of the most near and the most far electrode. Red line is the relative change of the most near versus the most far electrode.

Application Library path: ACDC_Module/Devices,_Capacitive/
capacitive_position_sensor



Modeling Instructions

From the **File** menu, choose **New**.

NEW

In the **New** window, click  **Model Wizard**.

MODEL WIZARD

- 1 In the **Model Wizard** window, click  **3D**.
- 2 In the **Select Physics** tree, select **AC/DC>Electric Fields and Currents>Electrostatics (es)**.
- 3 Click **Add**.
- 4 In the **Added physics interfaces** tree, select **Electrostatics (es)**.
- 5 Click  **Study**.

The following steps add the **Stationary Source Sweep** study step that automatically extracts the capacitance matrices for an N-port system, which is the final aim of this model.

- 6 In the **Select Study** tree, select **Preset Studies for Selected Physics Interfaces>Stationary Source Sweep**.
- 7 Click  **Done**.

GEOMETRY I

Add the nylon block with the five embedded rectangular electrodes.

Block 1 (blk1)

- 1 In the **Geometry** toolbar, click  **Block**.
- 2 In the **Settings** window for **Block**, locate the **Size and Shape** section.
- 3 In the **Width** text field, type 11 [cm].
- 4 In the **Depth** text field, type 11 [cm].
- 5 In the **Height** text field, type 1 [cm].

Work Plane 1 (wp1)

- 1 In the **Geometry** toolbar, click  **Work Plane**.

- 2 In the **Settings** window for **Work Plane**, locate the **Plane Definition** section.
- 3 In the **z-coordinate** text field, type 5[mm].
- 4 Locate the **Selections of Resulting Entities** section. Select the **Resulting objects selection** check box.
- 5 Click  **Show Work Plane**.

Work Plane 1 (wp1)>Rectangle 1 (r1)

- 1 In the **Work Plane** toolbar, click  **Rectangle**.
- 2 In the **Settings** window for **Rectangle**, locate the **Size and Shape** section.
- 3 In the **Width** text field, type 1[cm].
- 4 In the **Height** text field, type 11[cm].
- 5 Locate the **Position** section. In the **xw** text field, type 1[cm].

Work Plane 1 (wp1)>Array 1 (arr1)

- 1 In the **Work Plane** toolbar, click  **Transforms** and choose **Array**.
- 2 Select the object **r1** only.
- 3 In the **Settings** window for **Array**, locate the **Size** section.
- 4 In the **xw size** text field, type 5.
- 5 Locate the **Displacement** section. In the **xw** text field, type 2[cm].

Work Plane 1 (wp1)

- 1 In the **Model Builder** window, under **Component 1 (comp1)>Geometry 1** click **Work Plane 1 (wp1)**.
- 2 In the **Settings** window for **Work Plane**, click  **Build Selected**.

Form Union (fin)

Add an enclosing box for modeling the external air domain and add the corresponding materials.

Block 2 (blk2)

- 1 In the **Geometry** toolbar, click  **Block**.
- 2 In the **Settings** window for **Block**, locate the **Size and Shape** section.
- 3 In the **Width** text field, type 60[cm].
- 4 In the **Depth** text field, type 18[cm].
- 5 In the **Height** text field, type 18[cm].
- 6 Locate the **Position** section. In the **x** text field, type -40[cm].

7 In the **y** text field, type -4[cm].

8 In the **z** text field, type -4[cm].

After having built the air box, add a layer on its sides where **Infinite Elements** are specified.

9 Click to expand the **Layers** section. In the table, enter the following settings:

Layer name	Thickness (m)
Layer 1	2[cm]

10 Find the **Layer position** subsection. Select the **Left** check box.

11 Select the **Right** check box.

12 Select the **Front** check box.

13 Select the **Back** check box.

14 Select the **Top** check box.

15 Click  **Build Selected**.

16 Click the  **Zoom Extents** button in the **Graphics** toolbar.

DEFINITIONS

Infinite Element Domain 1 (ie1)

1 In the **Definitions** toolbar, click  **Infinite Element Domain**.

2 Select Domains 1–13, 15–18, and 20–28 only.

ADD MATERIAL

1 In the **Home** toolbar, click  **Add Material** to open the **Add Material** window.

2 Go to the **Add Material** window.

3 In the tree, select **Built-in>Air**.

4 Right-click and choose **Add to Component 1 (comp1)**.

5 In the tree, select **Built-in>Nylon**.

6 Right-click and choose **Add to Component 1 (comp1)**.

7 In the **Home** toolbar, click  **Add Material** to close the **Add Material** window.

MATERIALS

Nylon (mat2)

Select Domain 19 only.

ELECTROSTATICS (ES)

Ground 1

Apply ground and the five boundary terminal conditions.

- 1 In the **Model Builder** window, under **Component 1 (comp1)** right-click **Electrostatics (es)** and choose **Ground**.
- 2 Select Boundary 69 only.

The five different terminals can now be created by selecting all five domains at once, and then using the **Split by Connectivity** feature.

Terminal 1

- 1 In the **Physics** toolbar, click  **Boundaries** and choose **Terminal**.
- 2 In the **Settings** window for **Terminal**, locate the **Boundary Selection** section.
- 3 From the **Selection** list, choose **Work Plane 1**.

Terminal 5

Right-click **Terminal 1** and choose **Split by Connectivity**.

The **Physics Controlled Mesh** creates a proper swept mesh for the **Infinite Elements**. However, refine the mesh element size and run the model.

MESH 1

- 1 In the **Settings** window for **Mesh**, locate the **Physics-Controlled Mesh** section.
- 2 From the **Element size** list, choose **Finer**.

STUDY 1

In the **Home** toolbar, click  **Compute**.

RESULTS

Electric Potential (es)

Look at the potential when terminal 5 is fed.

PortName(5)=5

Multislice: V(es.VexcTerm (1))

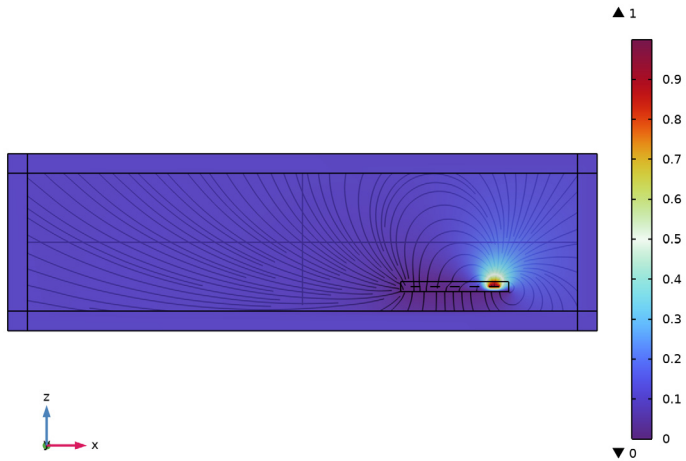

Repeat the following operations to look at the potential when each of the other four terminals are fed. The results should look as in the following plot.

- 1 In the **Settings** window for **3D Plot Group**, click  **Plot Previous**.

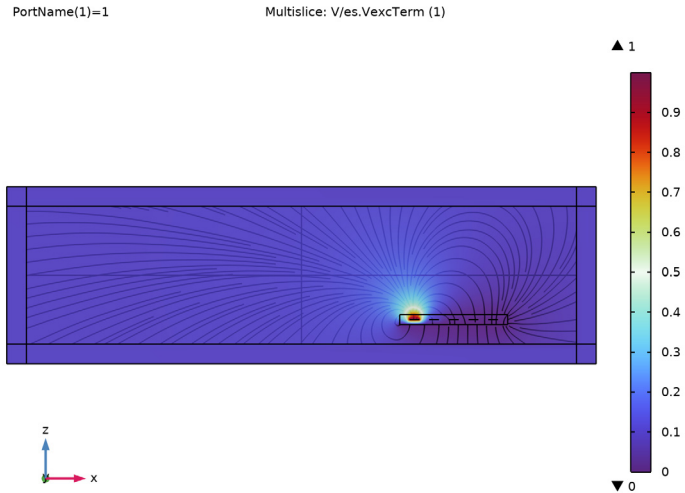

You can easily generate the inverse capacitance matrix, the Maxwell capacitance matrix, and mutual capacitance matrix by just a few clicks.

- 2 In the **Results** toolbar, click  **Evaluate** and choose **Clear and Evaluate All**.

Lumped Parameters (dset1, es)

In the **Model Builder** window, expand the **Lumped Parameters (dset1, es)** node.

Maxwell capacitance (dset1, es)

As the capacitances are really small numbers in the base SI unit, F, they can be postprocessed in pF by the following steps.

- 1 In the **Model Builder** window, expand the **Results>Lumped Parameters (dset1, es)>Maxwell capacitance (dset1, es)** node, then click **Maxwell capacitance (dset1, es)**.
- 2 In the **Settings** window for **Global Matrix Evaluation**, locate the **Expression** section.
- 3 From the **Unit** list, choose **1/pF**.

Mutual capacitance (dset1, es)

- 1 In the **Model Builder** window, expand the **Results>Lumped Parameters (dset1, es)>Mutual capacitance (dset1, es)** node, then click **Mutual capacitance (dset1, es)**.
- 2 In the **Settings** window for **Global Matrix Evaluation**, locate the **Expression** section.
- 3 From the **Unit** list, choose **1/pF**.
- 4 In the **Results** toolbar, click  **Evaluate** and choose **Clear and Evaluate All**.



Finally, it is possible to postprocess these matrix entries also as a table plot. To do this, follow the next instructions.

TABLE



- 1 Go to the **Table** window.
- 2 Click **Table Surface** in the window toolbar.

RESULTS

Table Surface 1

- 1 In the **Model Builder** window, under **Results>2D Plot Group 3** click **Table Surface 1**.
- 2 In the **Settings** window for **Table Surface**, locate the **Data** section.
- 3 From the **Data format** list, choose **Cells**.
- 4 Locate the **Coloring and Style** section. From the **Function** list, choose **Discrete**.
- 5 In the **2D Plot Group 3** toolbar, click  **Plot**.
- 6 Click the  **Zoom Extents** button in the **Graphics** toolbar.

2D Plot Group 3

- 1 In the **Model Builder** window, click **2D Plot Group 3**.
- 2 In the **Settings** window for **2D Plot Group**, click to expand the **Title** section.
- 3 From the **Title type** list, choose **Manual**.
- 4 In the **Title** text area, type Mutual capacitance matrix [pF].
- 5 In the **2D Plot Group 3** toolbar, click  **Plot**.
- 6 Click the  **Zoom Extents** button in the **Graphics** toolbar. The result should look like [Figure 7](#) in the introduction.

Configuration of a direct solver

If the model is not particularly big for the employed computer, the next instructions show how to switch from iterative solver to direct solver. If the model was detected to be sufficiently small, the direct solver would have been the default.

STUDY 1

Solver Configurations

In the **Model Builder** window, expand the **Study 1>Solver Configurations** node.

Solution 1 (sol1)

- 1 In the **Model Builder** window, expand the **Study 1>Solver Configurations>Solution 1 (sol1)>Stationary Solver 1** node.
- 2 Right-click **Direct** and choose **Enable**.
Now, solve and inspect the results and verify that the results have not changed.
- 3 In the **Home** toolbar, click  **Compute**.

RESULTS

- 1 In the **Results** toolbar, click  **Evaluate** and choose **Clear and Evaluate All**.
Conversely, if there is the need to decrease amount of required RAM, it is possible to manually enable the iterative solver.

Sensing the position of a metal billet

To model a copper metal billet entering the system and reaching different positions, a block is added with a parameterized position. A terminal, providing an equipotential boundary condition, is added to this block. Notice that the instruction includes also the addition of the material. This is not strictly necessary as the terminal condition would be enough for describing the conductor.

GLOBAL DEFINITIONS

Parameters 1

- 1 In the **Model Builder** window, under **Global Definitions** click **Parameters 1**.
- 2 In the **Settings** window for **Parameters**, locate the **Parameters** section.
- 3 In the table, enter the following settings:

Name	Expression	Value	Description
L	2[cm]	0.02 m	Displacement



GEOMETRY 1

Block 3 (blk3)

- 1 In the **Geometry** toolbar, click  **Block**.
- 2 In the **Settings** window for **Block**, locate the **Size and Shape** section.
- 3 In the **Width** text field, type 25[cm].
- 4 In the **Depth** text field, type 5[cm].

- 5 In the **Height** text field, type 8[cm].
- 6 Locate the **Position** section. In the **x** text field, type -35[cm]+L.
- 7 In the **y** text field, type 3[cm].
- 8 In the **z** text field, type 2[cm].
- 9 Click  **Build Selected**.

ADD MATERIAL

- 1 In the **Home** toolbar, click  **Add Material** to open the **Add Material** window.
- 2 Go to the **Add Material** window.
- 3 In the tree, select **Built-in>Copper**.
- 4 Right-click and choose **Add to Component 1 (comp1)**.
- 5 In the **Home** toolbar, click  **Add Material** to close the **Add Material** window.

MATERIALS

Copper (mat3)

Select Domain 19 only.

ELECTROSTATICS (ES)

The fastest way to model an electrically floating solid metal object is by adding a sixth terminal, where zero charge is specified. This is simply done adding a domain **Terminal**.

Terminal 6

- 1 In the **Physics** toolbar, click  **Domains** and choose **Terminal**.

2 Select Domain 19 only.

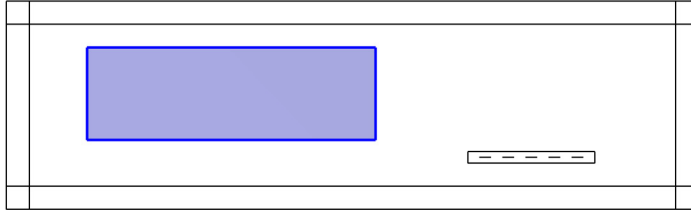

When clicking **Compute** now, a sweep over the six terminals is performed.

STUDY 1

In the **Home** toolbar, click  **Compute**.

RESULTS

In the **Results** toolbar, click  **Evaluate** and choose **Clear and Evaluate All**.

To exclude the block from the sweep, it is enough to modify the settings in the **Solve only for specified sources** section.

STUDY 1

Step 1: Stationary Source Sweep

- 1 In the **Model Builder** window, under **Study 1** click **Step 1: Stationary Source Sweep**.
- 2 In the **Settings** window for **Stationary Source Sweep**, locate the **Source Selection** section.
- 3 Select the **Solve only for specified sources** check box.
- 4 In the **Source names** text field, type range(1,1,5).
- 5 In the **Home** toolbar, click  **Compute**.

RESULTS

Electric Potential (es)

Regenerating the capacitance matrices, it is possible to appreciate that they are really similar to the initial case. The discrepancies are due mainly to the effect of the new conducting domain, which is currently far from the system and thereby not influencing its capacitive behavior.

1 In the **Results** toolbar, click  **Evaluate** and choose **Clear and Evaluate All**.

Parametric sweep for different billet positions

Add a **Parametric Sweep** controlling the metal billet displacement parameter **L**.

STUDY 1

Parametric Sweep

1 In the **Study** toolbar, click  **Parametric Sweep**.

2 In the **Settings** window for **Parametric Sweep**, locate the **Study Settings** section.

3 Click  **Add**.

4 In the table, enter the following settings:

Parameter name	Parameter value list	Parameter unit
L (Displacement)	range (2, 2, 28)	cm

5 In the **Study** toolbar, click  **Compute**.

RESULTS

Electric Potential (es) 1

The next instructions explain how to specify the position of the metal billet in the plot of the normalized electric potential.

1 In the **Settings** window for **3D Plot Group**, locate the **Data** section.

2 From the **Parameter value (PortName)** list, choose **I**.

L(1)=2 cm PortName(1)=1

Multislice: V/es.VexcTerm (1)

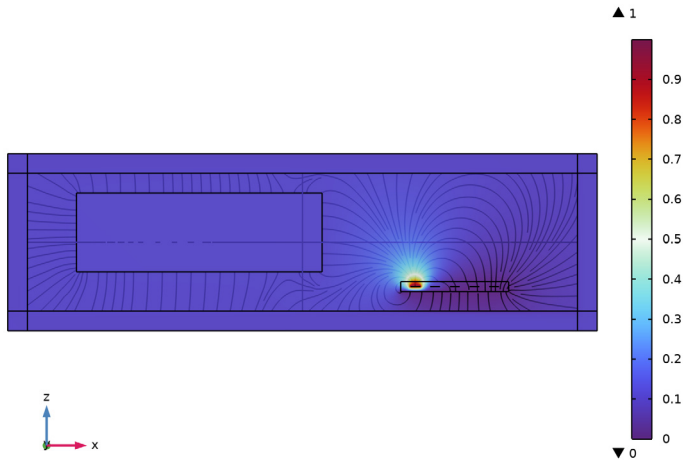

Finally, it is shown how to generate a 1D plot of the capacitance response for different positions.

1D Plot Group 6

- 1 In the **Home** toolbar, click  **Add Plot Group** and choose **ID Plot Group**.
- 2 In the **Settings** window for **ID Plot Group**, locate the **Data** section.
- 3 From the **Dataset** list, choose **Study 1/Parametric Solutions 1 (sol2)**.
- 4 Click to expand the **Title** section. From the **Title type** list, choose **Manual**.
- 5 In the **Title** text area, type Relative change of capacitance.

Global 1

- 1 Right-click **ID Plot Group 6** and choose **Global**.
- 2 In the **Settings** window for **Global**, locate the **Data** section.
- 3 From the **Dataset** list, choose **Study 1/Parametric Solutions 1 (sol2)**.
- 4 From the **Parameter selection (PortName)** list, choose **First**.
- 5 Locate the **x-Axis Data** section. From the **Axis source data** list, choose **L**.

6 Locate the **y-Axis Data** section. In the table, enter the following settings:

Expression	Unit	Description
<code>with(1,es.Cinv11)/withsol('sol3',with(1,es.Cinv11))</code>	1	Terminal 1
<code>with(5,es.Cinv55)/withsol('sol3',with(5,es.Cinv55))</code>	1	Terminal 5
<code>with(5,es.Cinv55)/with(1,es.Cinv11)/withsol('sol3',with(5,es.Cinv55)/with(1,es.Cinv11))</code>	1	Ratio of capacitances for terminal 1 vs. 5

7 Click to expand the **Legends** section. From the **Legends** list, choose **Manual**.

8 In the table, enter the following settings:

Legends
Change on terminal 1
Change on terminal 5
Relative change of 1 vs. 5

9 In the **ID Plot Group 6** toolbar, click  **Plot**. The resulting plot will look like [Figure 10](#) in the introduction.