

Created in COMSOL Multiphysics 6.0

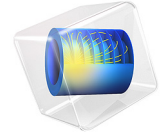

Trench-Gate IGBT 3D

This model is licensed under the [COMSOL Software License Agreement 6.0](#).
All trademarks are the property of their respective owners. See www.comsol.com/trademarks.

In this second half of a two-part example, a 3D model of a trench-gate IGBT is built by extruding the 2D model from the first half. Unlike the 2D model, now it is possible to arrange the alternating n+ and p+ emitters along the direction of extrusion as in the real device. This more realistic arrangement leads to better quantitative agreement with experimental data. The computed collector current density as a function of the collector voltage agrees reasonably well with the published result.

Introduction

In [Ref. 1](#), Watanabe et al. studied the effect of three-dimensional current flow on the simulation result by comparing 2D and 3D models of trench-gate IGBTs. They found that the 3D model reveals a nonuniform current distribution in the third dimension in the high current regime, where the current in the MOS channel region is limited by the electron supply from the n⁺-emitter. This nonuniform current distribution explains the reason why while the 3D model agrees well with measured result, the 2D model is off by the factor of the ratio of the n⁺-emitter length to the total emitter length.

In this example, we build the 3D model based on the 2D model in the previous example.

Model Definition

The model structure is detailed in [Ref. 1](#), with additional details in [Ref. 2](#).

Following the reference paper, the symmetry of the physics is used and only half of the cell is drawn in the geometry. Some thin regions are created under the gate and the emitter surface, in order to mesh those high-gradient regions with thin rectangles or isosceles trapezoids. The geometry sequence is imported from the 2D model, slightly modified, and then extruded to 3D.

The **Klaassen Unified Mobility Model** and **Caughey-Thomas Mobility Model** are used. The band gap, effective density of states, and the band-gap narrowing reference concentration are modified according to [Ref. 2](#). The **Contact resistance** option of metal contact boundary conditions is used to implement the mixed-mode simulation with parasitic resistance at the collector and emitter as mentioned in the reference paper. The physics is copied from the 2D model and pasted into the 3D model. Some settings still need to be updated, especially the selections and feature links such as for the mobility.

See the comments in the section [Modeling Instructions](#) for more detailed discussions on the model construction, solution processes, and result visualization.

Results and Discussion

Figure 1 and Figure 2 show the collector current density as a function of the collector voltage, to be compared with Fig. 4(a) and (b) in Ref. 1. Reasonable agreement is seen.

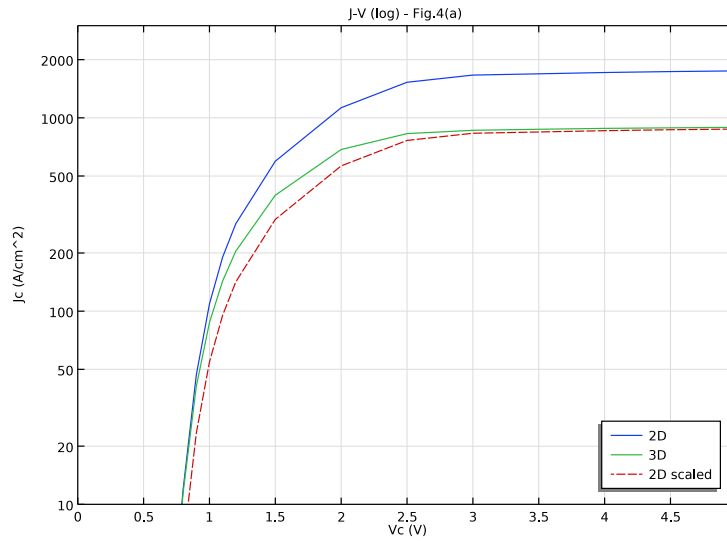

Figure 1: Collector current density as a function of the collector voltage, log scale.

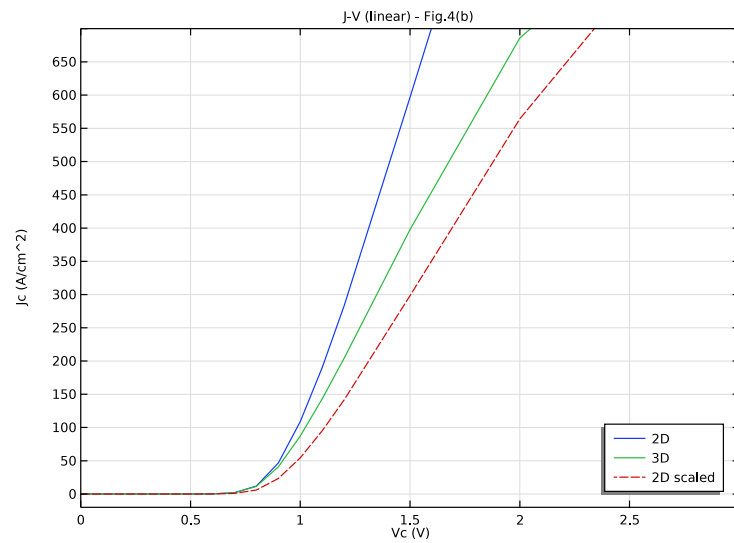

Figure 2: Collector current density as a function of the collector voltage, linear scale.

References

1. M. Watanabe and others, “Impact of three-dimensional current flow on accurate TCAD simulation for trench-gate IGBTs,” *31st International Symposium on Power Semiconductor Devices and ICs (ISPSD)*, pp. 311–314, 2019, doi: 10.1109/ISPSD.2019.8757640.

2. N. Shigyo and others, “Modeling and Simulation of Si IGBTs,” *2020 International Conference on Simulation of Semiconductor Processes and Devices (SISPAD)*, pp. 129–132, 2020, doi: 10.23919/SISPAD49475.2020.9241627.

Application Library path: Semiconductor_Module/Transistors/
trench_gate_igbt_3d

Modeling Instructions

ROOT

Open the existing Trench-Gate IGBT 2D model (filename: trench_gate_igbt_2d.mph).

APPLICATION LIBRARIES

- 1 From the **File** menu, choose **Application Libraries**.
- 2 In the **Application Libraries** window, select **Semiconductor Module>Transistors>trench_gate_igbt_2d** in the tree.
- 3 Click  **Open**.

Add a 3D component for the 3D model. Set the length unit to micrometers (same as in the 2D model).

ADD COMPONENT

In the **Home** toolbar, click  **Add Component** and choose **3D**.

GEOMETRY 2

- 1 In the **Settings** window for **Geometry**, locate the **Units** section.
- 2 From the **Length unit** list, choose **µm**.

Duplicate the 2D geometry on a workplane in 3D by importing the geometry sequence from the same existing 2D model. Then modify the contact window to match the actual 3D device. Extrude the workplane to form the 3D geometry.

Work Plane 1 (wp1)

- 1 In the **Geometry** toolbar, click  **Work Plane**.
- 2 In the **Settings** window for **Work Plane**, locate the **Plane Definition** section.
- 3 From the **Plane** list, choose **xz-plane**.

Work Plane 1 (wp1)>Plane Geometry

- 1 In the **Model Builder** window, click **Plane Geometry**.
- 2 In the **Work Plane** toolbar, click **Insert Sequence** and choose **Insert Sequence**.
- 3 Browse to the model's Application Libraries folder and double-click the file trench_gate_igbt_2d.mph.

Work Plane 1 (wp1)>Point 1 - Emitter contact & doping boundary (pt1)



- 1 In the **Model Builder** window, under **Component 2 (comp2)>Geometry 2>Work Plane 1 (wp1)>Plane Geometry** click **Point 1 - Emitter contact & doping boundary (pt1)**.
- 2 In the **Settings** window for **Point**, type Point 1 - Emitter contact in the **Label** text field.
- 3 Locate the **Point** section. In the **xw** text field, type $W_{win}/2$.
- 4 In the **yw** text field, type 0.

Extrude 1 (ext1)

- 1 In the **Model Builder** window, right-click **Geometry 2** and choose **Extrude**.
- 2 In the **Settings** window for **Extrude**, locate the **Distances** section.
- 3 In the table, enter the following settings:

Distances (μm)
-Ln/2
-Ln/2-Lp/2

Mesh Control Faces 1 (mcf1)

- 1 In the **Geometry** toolbar, click  **Virtual Operations** and choose **Mesh Control Faces**.
- 2 Click the  **Wireframe Rendering** button in the **Graphics** toolbar.
- 3 On the object **fin**, select Boundaries 12, 15, 28, 31, 40, 42, 43, 45, 47, 49, 51, 52, 54, 56, 67, 69, 73, 77, 80, and 82 only.

4 In the **Geometry** toolbar, click  **Build All**.

Add built-in silicon material.

ADD MATERIAL

1 In the **Home** toolbar, click  **Add Material** to open the **Add Material** window.

2 Go to the **Add Material** window.

3 In the tree, select **Semiconductors>Si - Silicon**.

4 Click **Add to Component** in the window toolbar.

5 In the **Home** toolbar, click  **Add Material** to close the **Add Material** window.

Copy the physics from the 2D component.

SEMICONDUCTOR (SEMI)

1 In the **Model Builder** window, expand the **Component 1 (comp1)** node.

2 Right-click **Component 1 (comp1)>Semiconductor (semi)** and choose **Copy**.

SEMICONDUCTOR (SEMI2)

1 In the **Model Builder** window, right-click **Component 2 (comp2)** and choose **Paste Semiconductor**.

2 In the **Messages from Paste** dialog box, click **OK**.

Go through the physics settings that have been lost during copy/paste.

Semiconductor Material Model 1

1 In the **Model Builder** window, expand the **Semiconductor (semi2)** node, then click **Semiconductor Material Model 1**.

2 In the **Settings** window for **Semiconductor Material Model**, locate the **Mobility Model** section.

3 From the μ_n list, choose **Electron mobility, Caughey-Thomas (semi2/smm1/mmct1)**.

4 From the μ_p list, choose **Hole mobility, Caughey-Thomas (semi2/smm1/mmct1)**.

5 Click to expand the **Band Gap Narrowing** section.

Caughey-Thomas Mobility Model (E) 1

1 In the **Model Builder** window, expand the **Semiconductor Material Model 1** node, then click **Caughey-Thomas Mobility Model (E) 1**.

2 In the **Settings** window for **Caughey-Thomas Mobility Model (E)**, locate the **Input Mobilities** section.

3 From the $\mu_{n,in}$ list, choose **Electron mobility, Klaassen unified (semi2/smm1/mmkl1)**.

4 From the $\mu_{p,in}$ list, choose **Hole mobility, Klaassen unified (semi2/smm1/mmkl1)**.

Analytic Doping Model - n-base

1 In the **Model Builder** window, under **Component 2 (comp2)>Semiconductor (semi2)** click **Analytic Doping Model - n-base**.

2 Select Domains 3 and 6 only.

Analytic Doping Model - n-buffer

1 In the **Model Builder** window, click **Analytic Doping Model - n-buffer**.

2 Select Domains 2 and 5 only.

Analytic Doping Model - p+ collector

1 In the **Model Builder** window, click **Analytic Doping Model - p+ collector**.

2 Select Domains 1 and 4 only.

Geometric Doping Model - p-base

1 In the **Model Builder** window, click **Geometric Doping Model - p-base**.

2 Select Domains 3 and 6 only.

Boundary Selection for Doping Profile 1

1 In the **Model Builder** window, expand the **Geometric Doping Model - p-base** node, then click **Boundary Selection for Doping Profile 1**.

2 Select Boundaries 10, 20, 24, 25, 30, and 31 only.

Geometric Doping Model - p+ emitter

1 In the **Model Builder** window, under **Component 2 (comp2)>Semiconductor (semi2)** click **Geometric Doping Model - p+ emitter**.

2 Select Domains 3 and 6 only.

Boundary Selection for Doping Profile 1

1 In the **Model Builder** window, expand the **Geometric Doping Model - p+ emitter** node, then click **Boundary Selection for Doping Profile 1**.

2 Select Boundaries 20 and 25 only.

Geometric Doping Model - n+ emitter

1 In the **Model Builder** window, under **Component 2 (comp2)>Semiconductor (semi2)** click **Geometric Doping Model - n+ emitter**.

2 Select Domains 3 and 6 only.

Boundary Selection for Doping Profile 1

- 1 In the **Model Builder** window, expand the **Geometric Doping Model - n+ emitter** node, then click **Boundary Selection for Doping Profile 1**.
- 2 Select Boundaries 10 and 24 only.

Trap-Assisted Recombination 1

- 1 In the **Model Builder** window, under **Component 2 (comp2)>Semiconductor (semi2)** click **Trap-Assisted Recombination 1**.
- 2 In the **Settings** window for **Trap-Assisted Recombination**, locate the **Domain Selection** section.
- 3 From the **Selection** list, choose **All domains**.

Metal Contact - Emitter

- 1 In the **Model Builder** window, click **Metal Contact - Emitter**.
- 2 Select Boundaries 10 and 20 only.
- 3 In the **Settings** window for **Metal Contact**, locate the **Terminal** section.
- 4 In the **Terminal name** text field, type E.

Metal Contact - Collector

- 1 In the **Model Builder** window, click **Metal Contact - Collector**.
- 2 Select Boundaries 3 and 13 only.
- 3 In the **Settings** window for **Metal Contact**, locate the **Terminal** section.
- 4 In the **Terminal name** text field, type C.



Thin Insulator Gate 1

- 1 In the **Model Builder** window, click **Thin Insulator Gate 1**.
- 2 Select Boundaries 26–29 only.
- 3 In the **Settings** window for **Thin Insulator Gate**, locate the **Terminal** section.
- 4 In the **Terminal name** text field, type G.

Build a similar 2D mesh on the front surface and then extrude it to 3D.

MESH 2

Edge 1 - Metal contact

- 1 In the **Mesh** toolbar, click  **Boundary** and choose **Edge**.
- 2 In the **Settings** window for **Edge**, type Edge 1 - Metal contact in the **Label** text field.
- 3 Click the  **Show Grid** button in the **Graphics** toolbar.

- 4 Click the  **Wireframe Rendering** button in the **Graphics** toolbar.
- 5 Select Edge 11 only.
- 6 Click to expand the **Control Entities** section. Clear the **Smooth across removed control entities** check box.

Distribution 1

- 1 Right-click **Edge 1 - Metal contact** and choose **Distribution**.
- 2 In the **Settings** window for **Distribution**, locate the **Distribution** section.
- 3 From the **Distribution type** list, choose **Predefined**.
- 4 In the **Number of elements** text field, type 2.
- 5 In the **Element ratio** text field, type 3.
- 6 Select the **Reverse direction** check box.

Size

- 1 In the **Model Builder** window, under **Component 2 (comp2)>Mesh 2** click **Size**.
- 2 In the **Settings** window for **Size**, locate the **Element Size** section.
- 3 Click the **Custom** button.
- 4 Locate the **Element Size Parameters** section. In the **Maximum element size** text field, type 9.1.
- 5 In the **Minimum element size** text field, type 0.04.
- 6 In the **Maximum element growth rate** text field, type 1.25.
- 7 In the **Curvature factor** text field, type 0.35.
- 8 In the **Resolution of narrow regions** text field, type 1.1.

Edge 2 - Emitter surface

- 1 In the **Mesh** toolbar, click  **Boundary** and choose **Edge**.
- 2 In the **Settings** window for **Edge**, type Edge 2 - Emitter surface in the **Label** text field.
- 3 Select Edge 31 only.
- 4 Locate the **Control Entities** section. Clear the **Smooth across removed control entities** check box.

Distribution 1

- 1 Right-click **Edge 2 - Emitter surface** and choose **Distribution**.
- 2 In the **Settings** window for **Distribution**, locate the **Distribution** section.
- 3 From the **Distribution type** list, choose **Predefined**.

- 4 In the **Number of elements** text field, type 8.
- 5 In the **Element ratio** text field, type 4.
- 6 Select the **Symmetric distribution** check box.

Copy Edge 1

- 1 In the **Model Builder** window, right-click **Mesh 2** and choose **Copying Operations> Copy Edge**.
- 2 Select Edges 11 and 31 only.
- 3 In the **Settings** window for **Copy Edge**, locate the **Destination Edges** section.
- 4 Click to select the  **Activate Selection** toggle button.
- 5 Select Edge 94 only.
- 6 Click to expand the **Control Entities** section. Clear the **Smooth across removed control entities** check box.

Mapped 1 - Emitter depth

- 1 In the **Mesh** toolbar, click  **Boundary** and choose **Mapped**.
- 2 In the **Settings** window for **Mapped**, type Mapped 1 - Emitter depth in the **Label** text field.
- 3 Select Boundary 45 only.
- 4 Click to expand the **Control Entities** section. Clear the **Smooth across removed control entities** check box.
- 5 Click to expand the **Reduce Element Skewness** section. Select the **Adjust edge mesh** check box.

Distribution 1

- 1 Right-click **Mapped 1 - Emitter depth** and choose **Distribution**.
- 2 Select Edges 68 and 105 only.
- 3 In the **Settings** window for **Distribution**, locate the **Distribution** section.
- 4 From the **Distribution type** list, choose **Predefined**.
- 5 In the **Element ratio** text field, type 3.
- 6 Select the **Reverse direction** check box.
- 7 Locate the **Edge Selection** section. Click  **Zoom to Selection**.

8 Click  **Build Selected**.

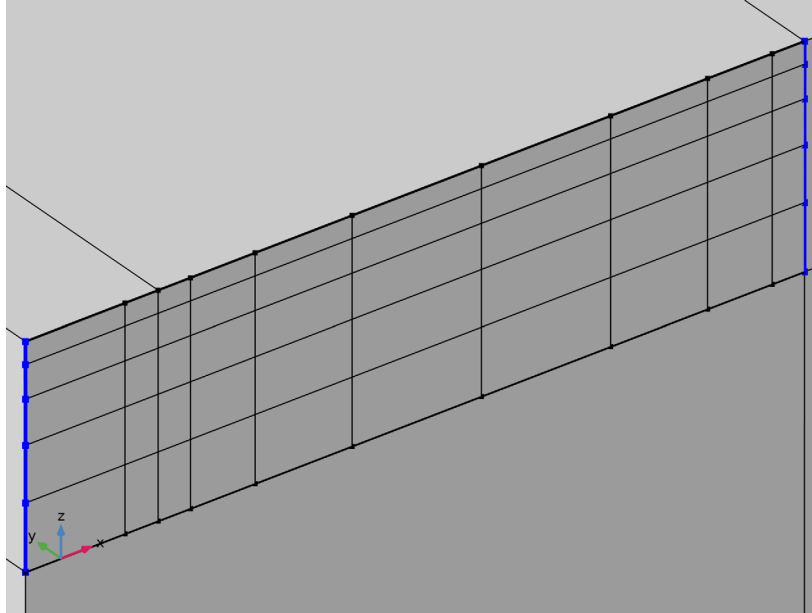

Copy Edge 2

- 1 In the **Model Builder** window, right-click **Mesh 2** and choose **Copying Operations> Copy Edge**.
- 2 Select Edge 105 only.
- 3 In the **Settings** window for **Copy Edge**, locate the **Destination Edges** section.
- 4 Click to select the **Activate Selection** toggle button.
- 5 Select Edge 35 only.
- 6 Locate the **Control Entities** section. Clear the **Smooth across removed control entities** check box.

Mapped 2 - Gate depth

- 1 In the **Mesh** toolbar, click  **Boundary** and choose **Mapped**.
- 2 In the **Settings** window for **Mapped**, type Mapped 2 - Gate depth in the **Label** text field.
- 3 Select Boundaries 41–44 only.
- 4 Locate the **Control Entities** section. Clear the **Smooth across removed control entities** check box.
- 5 Locate the **Reduce Element Skewness** section. Select the **Adjust edge mesh** check box.

Distribution 1 - Left depth

- 1 Right-click **Mapped 2 - Gate depth** and choose **Distribution**.
- 2 In the **Settings** window for **Distribution**, type Distribution 1 - Left depth in the **Label** text field.
- 3 Select Edges 73, 103, and 107 only.
- 4 Locate the **Distribution** section. From the **Distribution type** list, choose **Predefined**.
- 5 In the **Element ratio** text field, type 10.
- 6 Select the **Reverse direction** check box.

Distribution 2 - Right depth

- 1 In the **Model Builder** window, right-click **Mapped 2 - Gate depth** and choose **Distribution**.
- 2 In the **Settings** window for **Distribution**, type Distribution 2 - Right depth in the **Label** text field.
- 3 Select Edges 46 and 132 only.
- 4 Locate the **Distribution** section. From the **Distribution type** list, choose **Predefined**.
- 5 In the **Element ratio** text field, type 10.



Distribution 3 - Left surface

- 1 Right-click **Mapped 2 - Gate depth** and choose **Distribution**.
- 2 In the **Settings** window for **Distribution**, type Distribution 3 - Left surface in the **Label** text field.
- 3 Select Edges 76 and 101 only.
- 4 Locate the **Distribution** section. From the **Distribution type** list, choose **Predefined**.
- 5 In the **Number of elements** text field, type 20.
- 6 In the **Element ratio** text field, type 3.
- 7 Select the **Symmetric distribution** check box.

Distribution 4 - Right surface

- 1 Right-click **Mapped 2 - Gate depth** and choose **Distribution**.
- 2 In the **Settings** window for **Distribution**, type Distribution 4 - Right surface in the **Label** text field.
- 3 Select Edges 82 and 136 only.
- 4 Locate the **Distribution** section. From the **Distribution type** list, choose **Predefined**.
- 5 In the **Number of elements** text field, type 6.
- 6 In the **Element ratio** text field, type 4.

Distribution 5 - Bottom surface

- 1 Right-click **Mapped 2 - Gate depth** and choose **Distribution**.
- 2 In the **Settings** window for **Distribution**, type **Distribution 5 - Bottom surface** in the **Label** text field.
- 3 Select Edges 41, 77, 104, and 127 only.
- 4 Locate the **Distribution** section. From the **Distribution type** list, choose **Predefined**.
- 5 In the **Number of elements** text field, type 8.
- 6 Locate the **Edge Selection** section. Click  **Zoom to Selection**.
- 7 Click  **Build Selected**.

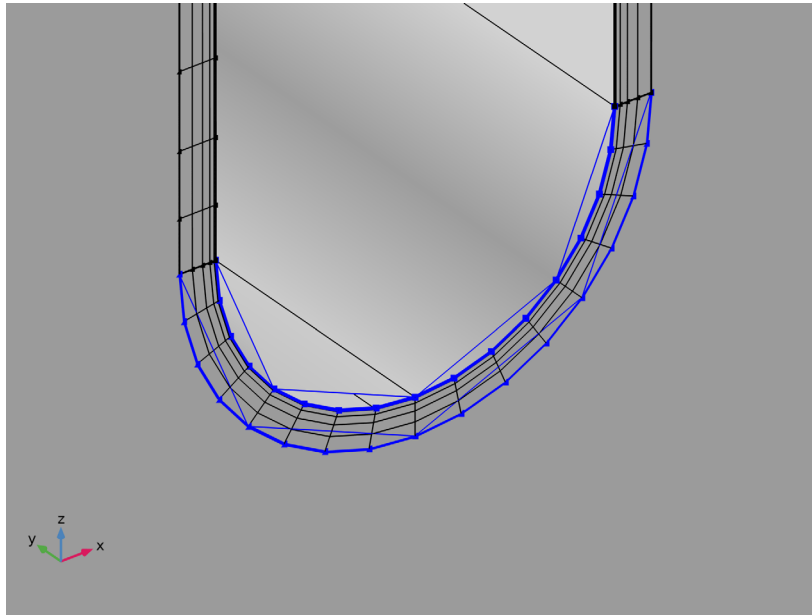

Free Triangular 1

- 1 In the **Mesh** toolbar, click  **Boundary** and choose **Free Triangular**.
- 2 Select Boundary 40 only.
- 3 In the **Settings** window for **Free Triangular**, click to expand the **Control Entities** section.
- 4 Clear the **Smooth across removed control entities** check box.

5 Click  **Build Selected**.

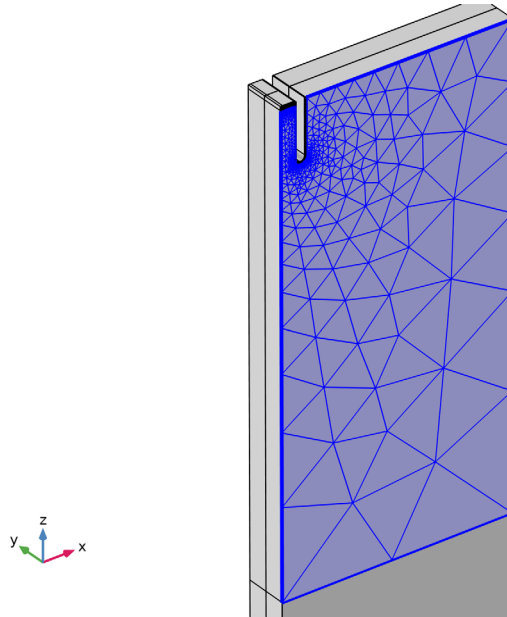

Copy Edge 3

- 1 In the **Model Builder** window, right-click **Mesh 2** and choose **Copying Operations> Copy Edge**.
- 2 Select Edge 92 only.
- 3 In the **Settings** window for **Copy Edge**, locate the **Destination Edges** section.
- 4 Click to select the **Activate Selection** toggle button.
- 5 Select Edges 3, 6, and 9 only.
- 6 Locate the **Control Entities** section. Clear the **Smooth across removed control entities** check box.

Mapped 3

- 1 In the **Mesh** toolbar, click  **Boundary** and choose **Mapped**.
- 2 Select Boundaries 2, 5, and 8 only.
- 3 In the **Settings** window for **Mapped**, locate the **Control Entities** section.
- 4 Clear the **Smooth across removed control entities** check box.
- 5 Locate the **Reduce Element Skewness** section. Select the **Adjust edge mesh** check box.

Distribution 1 - n-base

- 1 Right-click **Mapped 3** and choose **Distribution**.
- 2 In the **Settings** window for **Distribution**, type Distribution 1 - n-base in the **Label** text field.
- 3 Select Edges 7 and 88 only.
- 4 Locate the **Distribution** section. From the **Distribution type** list, choose **Predefined**.
- 5 In the **Number of elements** text field, type 10.
- 6 In the **Element ratio** text field, type 5.
- 7 Select the **Symmetric distribution** check box.

Distribution 2 - n-buffer

- 1 In the **Model Builder** window, right-click **Mapped 3** and choose **Distribution**.
- 2 In the **Settings** window for **Distribution**, type Distribution 2 - n-buffer in the **Label** text field.
- 3 Select Edges 4 and 52 only.
- 4 Locate the **Distribution** section. From the **Distribution type** list, choose **Predefined**.
- 5 In the **Element ratio** text field, type 10.

Distribution 3 - p+ collector

- 1 Right-click **Mapped 3** and choose **Distribution**.
- 2 In the **Settings** window for **Distribution**, type Distribution 3 - p+ collector in the **Label** text field.
- 3 Select Edges 1 and 50 only.
- 4 Locate the **Distribution** section. From the **Distribution type** list, choose **Predefined**.
- 5 In the **Number of elements** text field, type 3.
- 6 In the **Element ratio** text field, type 30.
- 7 Select the **Reverse direction** check box.

Swept 1

- 1 In the **Mesh** toolbar, click  **Swept**.
- 2 In the **Settings** window for **Swept**, locate the **Domain Selection** section.
- 3 From the **Geometric entity level** list, choose **Domain**.
- 4 Select Domains 1–3 and 7–12 only.
- 5 Click to expand the **Control Entities** section. Clear the **Smooth across removed control entities** check box.

Distribution 1

- 1 Right-click **Swept 1** and choose **Distribution**.
- 2 In the **Settings** window for **Distribution**, locate the **Distribution** section.
- 3 From the **Distribution type** list, choose **Predefined**.
- 4 In the **Number of elements** text field, type 4.
- 5 In the **Element ratio** text field, type 6.
- 6 Select the **Reverse direction** check box.

Swept 2

- 1 In the **Model Builder** window, under **Component 2 (comp2)>Mesh 2** right-click **Swept 1** and choose **Duplicate**.
- 2 In the **Settings** window for **Swept**, locate the **Domain Selection** section.
- 3 Click  **Clear Selection**.
- 4 Select Domains 4–6 and 13–18 only.

Distribution 1

- 1 In the **Model Builder** window, expand the **Swept 2** node, then click **Distribution 1**.
- 2 In the **Settings** window for **Distribution**, locate the **Distribution** section.
- 3 Clear the **Reverse direction** check box.
- 4 Click the  **Go to Default View** button in the **Graphics** toolbar.

5 Click  **Build All**.

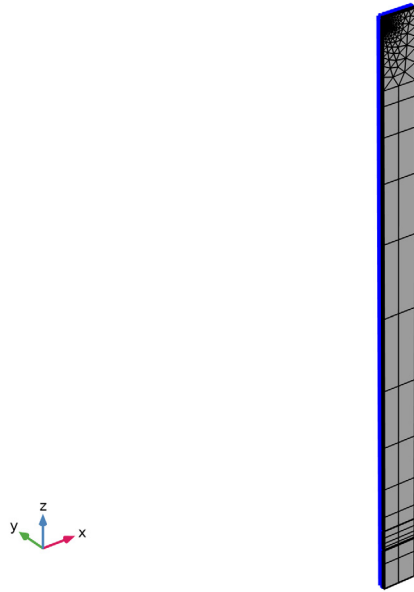

Disable the 3D model in the existing study.

STUDY 1 - 2D

- 1 In the **Model Builder** window, click **Study 1**.
- 2 In the **Settings** window for **Study**, type Study 1 - 2D in the **Label** text field.

Step 1: Semiconductor Equilibrium

- 1 In the **Model Builder** window, expand the **Study 1 - 2D** node, then click **Step 1: Semiconductor Equilibrium**.
- 2 In the **Settings** window for **Semiconductor Equilibrium**, locate the **Physics and Variables Selection** section.
- 3 Select the **Modify model configuration for study step** check box.
- 4 In the tree, select **Component 2 (Comp2)>Semiconductor (Semi2)**.
- 5 Click  **Disable in Model**.



Step 2: Stationary

- 1 In the **Model Builder** window, click **Step 2: Stationary**.
- 2 In the **Settings** window for **Stationary**, locate the **Physics and Variables Selection** section.

- 3 Select the **Modify model configuration for study step** check box.
- 4 In the tree, select **Component 2 (Comp2)>Semiconductor (Semi2)**.
- 5 Click  **Disable in Model**.

Add a study for the 3D model.

ADD STUDY

- 1 In the **Home** toolbar, click  **Add Study** to open the **Add Study** window.
- 2 Go to the **Add Study** window.
- 3 Find the **Studies** subsection. In the **Select Study** tree, select **Empty Study**.
- 4 Click **Add Study** in the window toolbar.
- 5 In the **Home** toolbar, click  **Add Study** to close the **Add Study** window.

STUDY 2 - 3D

In the **Settings** window for **Study**, type Study 2 - 3D in the **Label** text field.

STUDY 1 - 2D

Step 1: Semiconductor Equilibrium, Step 2: Stationary



- 1 In the **Model Builder** window, under **Study 1 - 2D**, Ctrl-click to select **Step 1: Semiconductor Equilibrium** and **Step 2: Stationary**.
- 2 Right-click and choose **Copy**.

STUDY 2 - 3D



Step 1: Semiconductor Equilibrium

In the **Model Builder** window, right-click **Study 2 - 3D** and choose **Paste Multiple Items**.

Step 1: Semiconductor Equilibrium, Step 2: Stationary

- 1 In the **Model Builder** window, under **Study 2 - 3D**, Ctrl-click to select **Step 1: Semiconductor Equilibrium** and **Step 2: Stationary**.
- 2 In the **Settings** window for **Semiconductor Equilibrium**, locate the **Physics and Variables Selection** section.
- 3 In the tree, select **Component 1 (Comp1)>Semiconductor (Semi)**.
- 4 Click  **Disable in Model**.
- 5 In the tree, select **Component 2 (Comp2)>Semiconductor (Semi2)**.
- 6 Click  **Solve For**.

Step 2: Stationary

- 1 In the **Model Builder** window, click **Step 2: Stationary**.
- 2 In the **Settings** window for **Stationary**, locate the **Physics and Variables Selection** section.
- 3 In the tree, select **Component 1 (Comp1)>Semiconductor (Semi)**.
- 4 Click  **Disable in Model**.
- 5 In the tree, select **Component 2 (Comp2)>Semiconductor (Semi2)**.
- 6 Click  **Solve For**.
Similar to the 2D model, use initial value based scaling and manual scaling for better error estimate for the second study step.
- 7 In the **Study** toolbar, click  **Get Initial Value**.

STUDY 2 - 3D

Solver Configurations

In the **Model Builder** window, expand the **Study 2 - 3D>Solver Configurations** node.

Solution 3 (sol3)

- 1 In the **Model Builder** window, expand the **Study 2 - 3D>Solver Configurations>Solution 3 (sol3)** node, then click **Dependent Variables 2**.
- 2 In the **Settings** window for **Dependent Variables**, locate the **Scaling** section.
- 3 From the **Method** list, choose **Initial value based**.
- 4 In the **Model Builder** window, expand the **Study 2 - 3D>Solver Configurations>Solution 3 (sol3)>Dependent Variables 2** node, then click **Voltage drop across contact (comp2.semi2.V_dae)**.
- 5 In the **Settings** window for **Field**, locate the **Scaling** section.
- 6 From the **Method** list, choose **Manual**.
- 7 In the **Study** toolbar, click  **Compute**.

Update the Jc-Vc plots to compare with the reference paper.

RESULTS

Global 1 - 3D

- 1 In the **Model Builder** window, expand the **Results>J-V (log) - Fig.4(a)** node.
- 2 Right-click **Global 1 - 2D** and choose **Duplicate**.
- 3 In the **Settings** window for **Global**, type Global 1 - 3D in the **Label** text field.
- 4 Locate the **Data** section. From the **Dataset** list, choose **Study 2 - 3D/Solution 3 (sol3)**.

5 Locate the **y-Axis Data** section. In the table, enter the following settings:

Expression	Unit	Description
semi2.J0_C	A/cm ²	3D

Global I - 2D scaled

- 1 Right-click **Global I - 2D** and choose **Duplicate**.
- 2 In the **Settings** window for **Global**, type Global 1 - 2D scaled in the **Label** text field.
- 3 Locate the **y-Axis Data** section. In the table, enter the following settings:

Expression	Unit	Description
semi.J0_C*Ln/(Ln+Lp)	A/cm ²	2D scaled

- 4 Click to expand the **Coloring and Style** section. Find the **Line style** subsection. From the **Line** list, choose **Dashed**.

J-V (log) - Fig.4(a)

- 1 In the **Model Builder** window, click **J-V (log) - Fig.4(a)**.
- 2 In the **Settings** window for **ID Plot Group**, click to expand the **Title** section.
- 3 From the **Title type** list, choose **Label**.
- 4 Locate the **Plot Settings** section. Select the **y-axis label** check box.
- 5 In the associated text field, type J_c (A/cm²).

6 In the **J-V (log) - Fig.4(a)** toolbar, click  **Plot**.

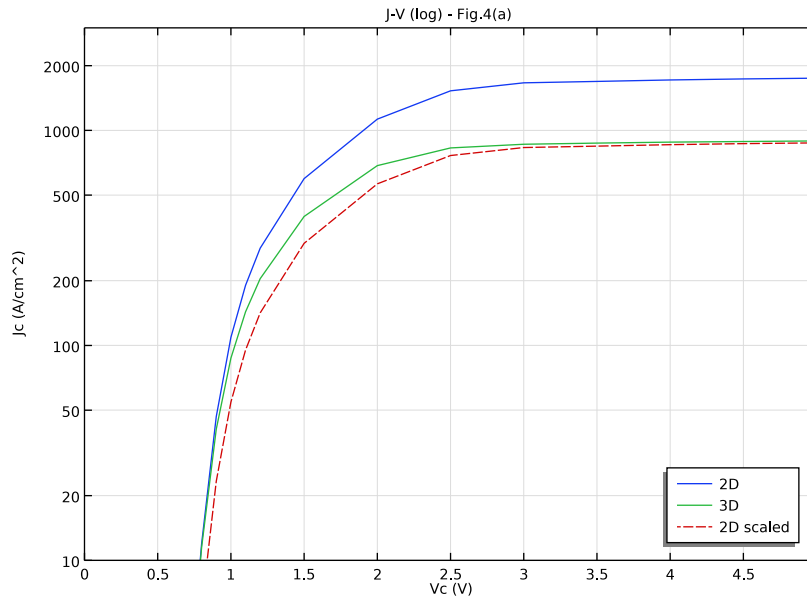

Global I - 2D scaled, Global I - 3D

1 In the **Model Builder** window, under **Results>J-V (log) - Fig.4(a)**, Ctrl-click to select **Global I - 3D** and **Global I - 2D scaled**.

2 Right-click and choose **Copy**.

Global I - 3D

In the **Model Builder** window, right-click **J-V (linear) - Fig.4(b)** and choose **Paste Multiple Items**.

J-V (linear) - Fig.4(b)

1 In the **Settings** window for **ID Plot Group**, locate the **Title** section.

2 From the **Title type** list, choose **Label**.

3 Locate the **Plot Settings** section. Select the **y-axis label** check box.

4 In the associated text field, type $J_c \text{ (A/cm}^2\text{)}$.

5 In the **J-V (linear) - Fig.4(b)** toolbar, click  **Plot**.

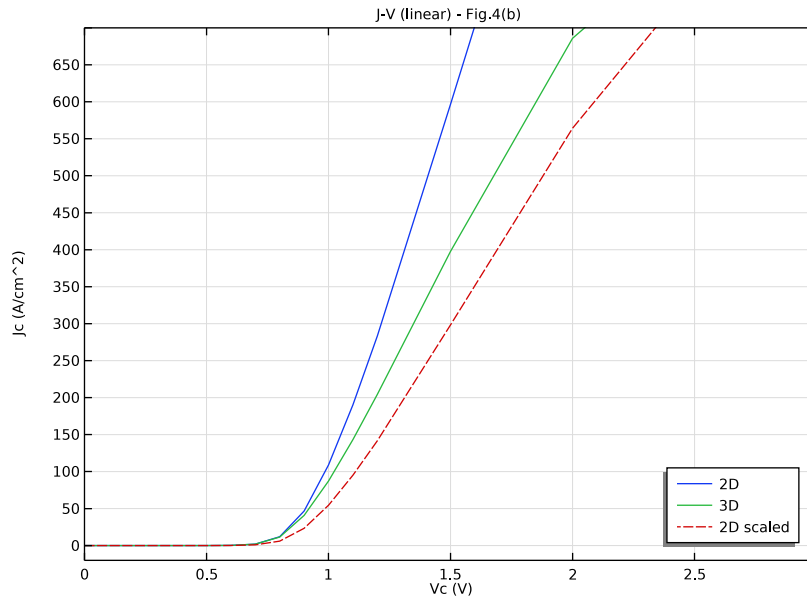

Finally plot the electron and hole current streamlines on top of the electron concentration as the model thumbnail. Notice how the electron current in the MOS channel region is nonuniform as mentioned in the reference paper. First zoom in to the region around the gate, then add the streamlines. Add transparency to the volume plot of the electron concentration to reveal the streamlines.

SEMICONDUCTOR (SEMI2)

Thin Insulator Gate I

- 1 In the **Model Builder** window, under **Component 2 (comp2)>Semiconductor (semi2)** click **Thin Insulator Gate I**.
- 2 In the **Settings** window for **Thin Insulator Gate**, locate the **Boundary Selection** section.
- 3 Click  **Zoom to Selection**.

RESULTS

Electron Concentration & Current Streamlines 3D

- 1 In the **Model Builder** window, under **Results** click **Electron Concentration (semi2)**.

- 2 In the **Settings** window for **3D Plot Group**, type Electron Concentration & Current Streamlines 3D in the **Label** text field.

Streamline 1 - Electron current

- 1 Right-click **Electron Concentration & Current Streamlines 3D** and choose **Streamline**.
- 2 In the **Settings** window for **Streamline**, type Streamline 1 - Electron current in the **Label** text field.
- 3 Click **Replace Expression** in the upper-right corner of the **Expression** section. From the menu, choose **Component 2 (comp2)>Semiconductor>Currents and charge>Electron current>semi2.JnX,...,semi2.JnZ - Electron current density**.
- 4 Select Boundary 10 only.
- 5 Locate the **Coloring and Style** section. Find the **Point style** subsection. From the **Color** list, choose **Black**.

Streamline 2 - Hole current

- 1 Right-click **Electron Concentration & Current Streamlines 3D** and choose **Streamline**.
- 2 In the **Settings** window for **Streamline**, type Streamline 2 - Hole current in the **Label** text field.
- 3 Click **Replace Expression** in the upper-right corner of the **Expression** section. From the menu, choose **Component 2 (comp2)>Semiconductor>Currents and charge>Hole current>semi2.JpX,...,semi2.JpZ - Hole current density**.
- 4 Select Boundary 20 only.
- 5 Locate the **Coloring and Style** section. Find the **Point style** subsection. From the **Color** list, choose **White**.

Transparency 1

- 1 In the **Model Builder** window, right-click **Volume 1** and choose **Transparency**.

2 In the **Electron Concentration & Current Streamlines 3D** toolbar, click  **Plot**.

