



# Double Gauss Lens

## Introduction

---

A double Gauss lens is a multiple element objective lens commonly used in imaging systems. It is capable of high quality imagery over moderately large field angles, at modest to high speed. In this tutorial, a double Gauss lens model (Figure 1) is constructed using multiple instances of standard parts from the built-in Part Library for the Ray Optics Module. The results of a ray trace will be presented together with a spot diagram and a wavefront aberration diagram.

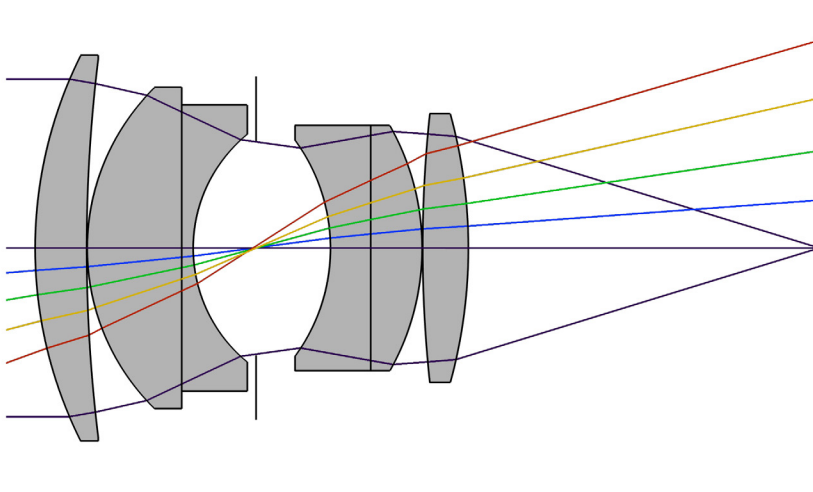

*Figure 1: Overview of the double Gauss lens used in this tutorial. In this view the marginal rays of an on-axis trace are shown, together with the chief ray of 4 additional fields.*

## Model Definition

---

The double Gauss lens simulated in this tutorial is an  $f/1.7$ , 100.2 mm focal length,  $19^\circ$  field of view lens by Lautebacher & Brendel (Agfa Camera-Werk AG, U.S. Patent 2784643), from Ref. 1, p. 323, although some materials have been replaced with equivalent optical glasses. The prescription of this lens is given in Table 1 and the instructions for creating the lens can be found in the Appendix — Geometry Instructions.

The lens geometry is created by inserting each lens element (including the stop) sequentially, such that each subsequent lens is placed relative to the prior one. This process

is simplified by making use of the predefined work planes within the part instances. It is important to appreciate that the ray tracing method used by the Geometrical Optics interface is inherently nonsequential, so the same result could be obtained by placing part instances within the geometry in any order. The double Gauss lens geometry sequence is shown in Figure 2 and the default, Physics-controlled mesh, is seen in Figure 3.

In addition to the lens parameters used to define the lens geometry, a set of parameters are required to define the ray trace. These are detailed in Table 2.

TABLE 1: DOUBLE GAUSS LENS PARAMETERS.

Index	Name	Radius (mm)	Thickness (mm)	Material	Clear radius (mm)
—	Object	$\infty$	$\infty$	—	—
1	Lens 1	75.050	9.000	S-LAM 3	33.0
—	—	270.700	0.100	—	33.0
2	Lens 2	39.270	16.510	S-BAH 11	27.5
3	Lens 3	$\infty$	2.000	N-SF5	24.5
—	—	25.650	10.990	—	19.5
4	Stop	$\infty$	13.000	—	18.6
5	Lens 4	-31.870	7.030	N-SF5	18.5
6	Lens 5	$\infty$	8.980	S-LAM 3	21.0
—	—	-43.510	0.100	—	21.0
7	Lens 6	221.140	7.980	S-BAH 11	23.0
—	—	-88.790	61.418	—	23.0
—	Image	$\infty$	—	—	42.5

TABLE 2: GLOBAL PARAMETER DEFINITIONS.

Parameter	Value	Description
$\lambda_{\text{vac}}$	550 nm	Nominal (vacuum) wavelength
$\theta_x$	0°	Nominal $x$ field angle
$\theta_y$	0°	Nominal $y$ field angle
$N_{\text{ring}}$	18	Number of hexapolar rings. ( $N_{\text{ring}} = 18$ will give a total of 1027 rays.)
$P_{\text{nom}}$	58.941 mm	Nominal entrance pupil diameter
$P_{\text{fac1}}$	-1.15	Pupil shift factor 1
$P_{\text{fac2}}$	-0.60	Pupil shift factor 2

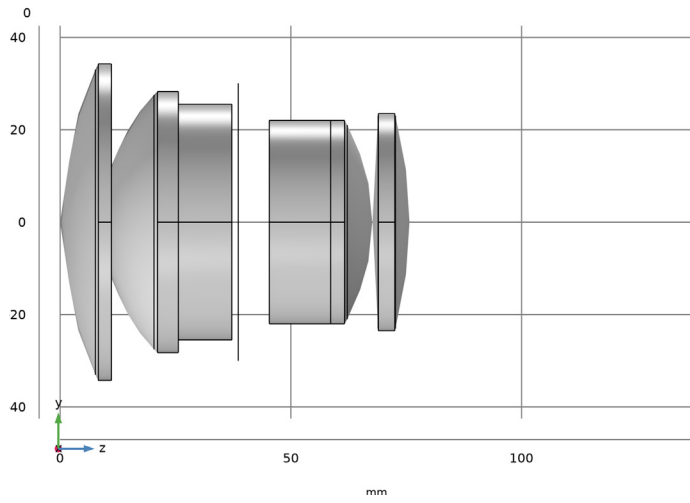

Figure 2: The double Gauss lens geometry sequence.

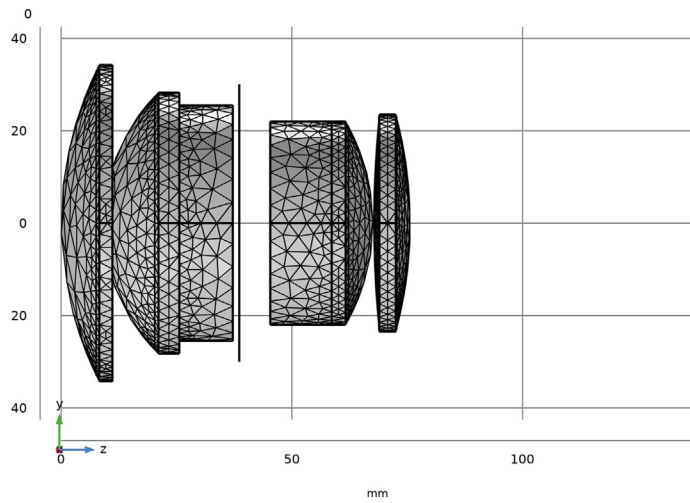

Figure 3: The default Physics-controlled mesh for the double Gauss lens.

Several of the parameters defined in Table 2 are used to derive additional parameters such as the ray direction vector components, the stop and image plane  $z$ -coordinates, as well as the entrance pupil location. Table 3 gives the expressions used to derived these parameters. Note that the pupil shift factor is used in a empirical approximation to ensure that the chief ray passes through the center of the stop at all field angles.

TABLE 3: GLOBAL PARAMETER DEFINITIONS (DERIVED).

Parameter	Value	Description
$v_x$	$\tan \theta_x$	Ray direction vector, $x$ -component
$v_y$	$\tan \theta_y$	Ray direction vector, $y$ -component
$v_z$	1	Ray direction vector, $z$ -component
$z_{\text{stop}}$	$\sum_{n=1}^3 (T_{c,n} + T_n)$	Stop $z$ -coordinate, where $T_{c,n}$ is the central thickness of element $n$ and $T_n$ is the separation between elements $n$ and $n+1$ . Note that the stop is the 4th element in the double Gauss lens.
$z_{\text{image}}$	$\sum_{n=1}^7 (T_{c,n} + T_n)$	Image plane $z$ -coordinate, where $T_{c,n}$ is the central thickness of element $n$ and $T_n$ is the separation between elements $n$ and $n+1$ . Including the stop, the double Gauss lens has 7 elements.
$P_{\text{fac}}$	$P_{\text{fac1}} + P_{\text{fac2}} \sin \theta$	Pupil shift factor, where $\theta = \sqrt{\theta_x^2 + \theta_y^2}$
$\Delta x_{\text{pupil}}$	$(\Delta z_{\text{pupil}} + P_{\text{fac}} z_{\text{stop}}) \tan \theta_x$	Pupil shift, $x$ -coordinate
$\Delta y_{\text{pupil}}$	$(\Delta z_{\text{pupil}} + P_{\text{fac}} z_{\text{stop}}) \tan \theta_y$	Pupil shift, $y$ -coordinate

## Results and Discussion

A ray trace has been made at a single wavelength (550 nm) and field angle (on-axis). In Figure 4 the ray trajectories can be seen colored by optical path length and in Figure 5, a color expression based on the location of the rays at the image plane is used.

Spot diagrams at both the nominal and refocused image plane are shown in Figure 6. The refocused spot diagram in Figure 6 uses an **Intersection Point 3D** dataset which has been automatically positioned on the plane which minimizes the *RMS* spot size. At this wavelength and field angle, this plane is located 180  $\mu\text{m}$  ahead of the nominal image surface.

Figure 7 shows the wavefront error. After removing piston and defocus, it is possible to see that spherical aberration dominates the remaining terms.

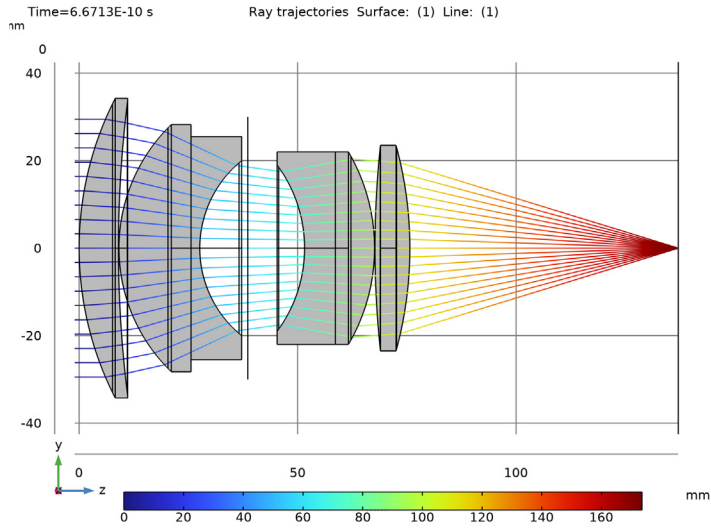

Figure 4: Ray diagram of the double Gauss lens colored by optical path length.

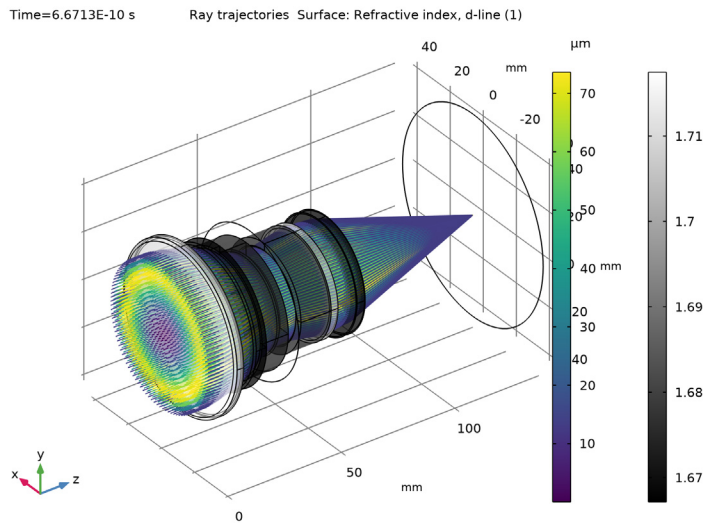

Figure 5: Ray diagram of the double Gauss lens where the rays are colored by their radial distance from the centroid on the image plane.

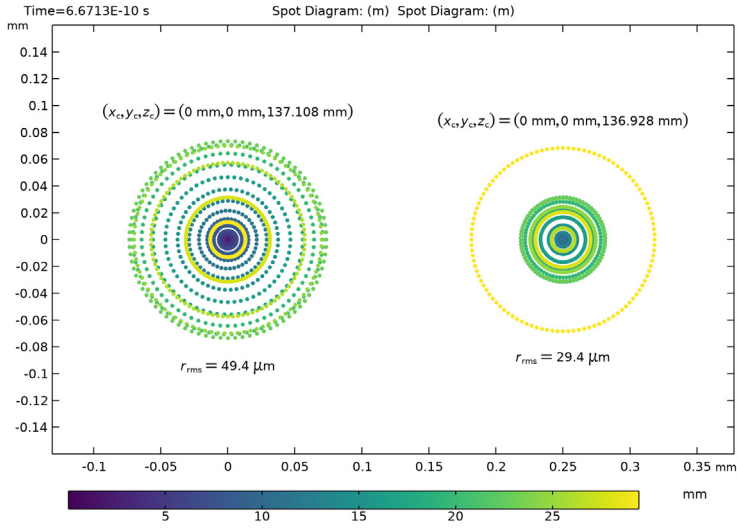

Figure 6: Spot diagram for the double Gauss lens. The spot on the nominal image plane is on the left, and the spot on the best focus plane is seen on the right.

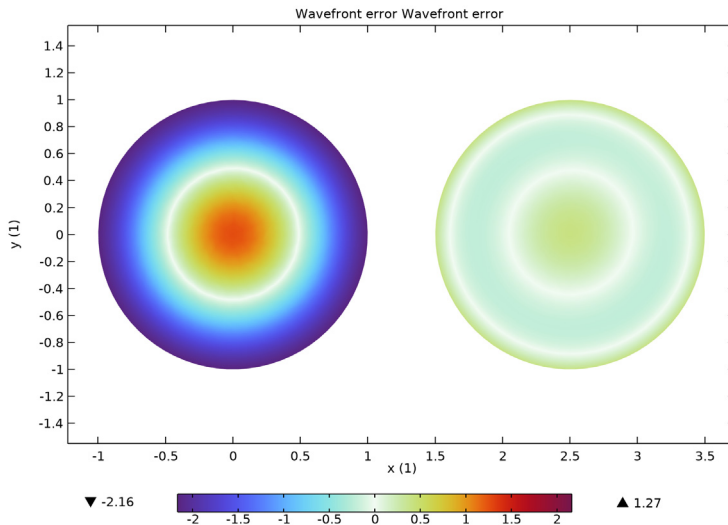

Figure 7: The double Gauss lens optical aberration diagram. The plot on the left uses all Zernike terms. On the right, piston and defocus are removed.

## Reference

---

1. W.J. Smith, *Modern lens design*, vol. 2. New York, NY, USA: McGraw-Hill, 2005.

---

**Application Library path:** Ray\_Optics\_Module/Lenses\_Cameras\_and\_Telescopes/  
double\_gauss\_lens

---

## Modeling Instructions



---

From the **File** menu, choose **New**.

### NEW

In the **New** window, click  **Model Wizard**.

### MODEL WIZARD

- 1 In the **Model Wizard** window, click  **3D**.
- 2 In the **Select Physics** tree, select **Optics>Ray Optics>Geometrical Optics (gop)**.
- 3 Click **Add**.
- 4 Click  **Study**.
- 5 In the **Select Study** tree, select **Preset Studies for Selected Physics Interfaces>Ray Tracing**.
- 6 Click  **Done**.



### GLOBAL DEFINITIONS

#### *Parameters 1: Lens Prescription*

- 1 In the **Model Builder** window, under **Global Definitions** click **Parameters 1**.
- 2 In the **Settings** window for **Parameters**, type Parameters 1: Lens Prescription in the **Label** text field. The lens prescription will be added when the geometry sequence is inserted in the following section.

#### *Parameters 2: General*

The double Gauss lens simulation parameters can be loaded from a text file.

- 1 In the **Home** toolbar, click  **Parameters** and choose **Add>Parameters**.
- 2 In the **Settings** window for **Parameters**, type Parameters 2: General in the **Label** text field.
- 3 Locate the **Parameters** section. Click  **Load from File**.







- 4 Browse to the model's Application Libraries folder and double-click the file `double_gauss_lens_parameters.txt`.

### COMPONENT 1 (COMP1)

- 1 In the **Model Builder** window, click **Component 1 (comp1)**.
- 2 In the **Settings** window for **Component**, locate the **Curved Mesh Elements** section.
- 3 From the **Geometry shape function** list, choose **Cubic Lagrange**. The ray tracing algorithm used by the Geometrical Optics interface computes the refracted ray direction based on a discretized geometry via the underlying finite element mesh. A cubic geometry shape order usually introduces less discretization error compared to the default, which uses linear and quadratic polynomials.

### DOUBLE GAUSS LENS

Insert the prepared geometry sequence from file. You can read the instructions for creating the geometry in the appendix. Following insertion, the lens definitions will be available in the **Parameters** node.

- 1 In the **Model Builder** window, under **Component 1 (comp1)** click **Geometry 1**.
- 2 In the **Settings** window for **Geometry**, type `Double Gauss Lens` in the **Label** text field.
- 3 In the **Geometry** toolbar, click **Insert Sequence** and choose **Insert Sequence**.
- 4 Browse to the model's Application Libraries folder and double-click the file `double_gauss_lens_geom_sequence.mph`.
- 5 In the **Geometry** toolbar, click  **Build All**.
- 6 Click the  **Orthographic Projection** button in the **Graphics** toolbar.
- 7 In the **Graphics** window toolbar, click  next to  **Go to Default View**, then choose **Go to ZY View**. Orient the view to place the  $z$ -axis (optical axis) horizontal and the  $y$ -axis vertical. Compare the resulting geometry to [Figure 2](#).

### MATERIALS

Load the materials used by each of the lenses.

### ADD MATERIAL

- 1 In the **Home** toolbar, click  **Add Material** to open the **Add Material** window.
- 2 Go to the **Add Material** window.
- 3 In the tree, select **Optical>Ohara Glass>Ohara S-LAM 3 Glass**.
- 4 Click **Add to Component** in the window toolbar.

- 5 In the tree, select **Optical>Ohara Glass>Ohara S-BAH I I Glass**.
- 6 Click **Add to Component** in the window toolbar.
- 7 In the tree, select **Optical>Schott Glass>Schott N-SF5 Glass**.
- 8 Click **Add to Component** in the window toolbar.
- 9 In the **Home** toolbar, click  **Add Material** to close the **Add Material** window.

## MATERIALS

### *Ohara S-LAM 3 Glass (mat1)*

- 1 In the **Model Builder** window, under **Component 1 (comp1)>Materials** click **Ohara S-LAM 3 Glass (mat1)**.
- 2 In the **Settings** window for **Material**, locate the **Geometric Entity Selection** section.
- 3 From the **Selection** list, choose **Lens Material 1**.

### *Ohara S-BAH I I Glass (mat2)*

- 1 In the **Model Builder** window, click **Ohara S-BAH I I Glass (mat2)**.
- 2 In the **Settings** window for **Material**, locate the **Geometric Entity Selection** section.
- 3 From the **Selection** list, choose **Lens Material 2**.

### *Schott N-SF5 Glass (mat3)*

- 1 In the **Model Builder** window, click **Schott N-SF5 Glass (mat3)**.
- 2 In the **Settings** window for **Material**, locate the **Geometric Entity Selection** section.
- 3 From the **Selection** list, choose **Lens Material 3**.

## GEOMETRICAL OPTICS (GOP)

- 1 In the **Model Builder** window, under **Component 1 (comp1)** click **Geometrical Optics (gop)**.
- 2 In the **Settings** window for **Geometrical Optics**, locate the **Ray Release and Propagation** section.
- 3 In the **Maximum number of secondary rays** text field, type 0. In this simulation stray light is not being traced, so reflected rays will not be produced at the lens surfaces.
- 4 Select the **Use geometry normals for ray-boundary interactions** check box. This ensures that geometry normals are used to apply the boundary conditions on all refracting surfaces. This is appropriate for the highest accuracy ray traces in single-physics simulations, where the geometry is not deformed.
- 5 Locate the **Material Properties of Exterior and Unmeshed Domains** section. From the **Optical dispersion model** list, choose **Air, Edlen (1953)**. It is assumed that the double Gauss lens is surrounded by air at room temperature.

- 6 Locate the **Additional Variables** section. Select the **Compute optical path length** check box. The optical path length will be used to create an **Optical Aberration** plot.

#### *Medium Properties I*

- 1 In the **Model Builder** window, under **Component 1 (comp1)>Geometrical Optics (gop)** click **Medium Properties I**.
- 2 In the **Settings** window for **Medium Properties**, locate the **Medium Properties** section.
- 3 From the **Refractive index of domains** list, choose **Get dispersion model from material**.  
Each of the materials added above contain the optical dispersion coefficients which can be used to compute the refractive index as a function of wavelength.

#### *Material Discontinuity I*

- 1 In the **Model Builder** window, click **Material Discontinuity I**.
- 2 In the **Settings** window for **Material Discontinuity**, locate the **Rays to Release** section.
- 3 From the **Release reflected rays** list, choose **Never**.

#### *Ray Properties I*

- 1 In the **Model Builder** window, click **Ray Properties I**.
- 2 In the **Settings** window for **Ray Properties**, locate the **Ray Properties** section.
- 3 In the  $\lambda_0$  text field, type lambda. This wavelength is defined in the **Parameters** node.

#### *Release from Grid I*

Release the rays from a hexapolar grid, using the quantities defined in the **Parameters** node.

- 1 In the **Physics** toolbar, click  **Global** and choose **Release from Grid**.
- 2 In the **Settings** window for **Release from Grid**, locate the **Initial Coordinates** section.
- 3 From the **Grid type** list, choose **Hexapolar**.
- 4 Specify the  $\mathbf{q}_c$  vector as

dx	x
dy	y
dz	z

The **Center location** of the hexapolar grid will change according to the field angle.

5 Specify the  $\mathbf{r}_c$  vector as

nix	x
niy	y
niz	z

The **Cylinder axis direction** is the same as the global optical axis.

6 In the  $R_c$  text field, type  $P_{\text{nom}}/2$ .

7 In the  $N_c$  text field, type  $N_{\text{ring}}$ .

8 Locate the **Ray Direction Vector** section. Specify the  $\mathbf{L}_0$  vector as

vX	x
vY	y
vZ	z

The **Ray direction vector** is calculated using the field angles defined in the **Parameters** node.

#### *Obstructions*

1 In the **Physics** toolbar, click  **Boundaries** and choose **Wall**.

2 In the **Settings** window for **Wall**, type **Obstructions** in the **Label** text field.

3 Locate the **Boundary Selection** section. From the **Selection** list, choose **Obstructions**.

4 Locate the **Wall Condition** section. From the **Wall condition** list, choose **Disappear**.

#### *Stop*

1 In the **Physics** toolbar, click  **Boundaries** and choose **Wall**.

2 In the **Settings** window for **Wall**, type **Stop** in the **Label** text field.

3 Locate the **Boundary Selection** section. From the **Selection** list, choose **Aperture Stop**.

4 Locate the **Wall Condition** section. From the **Wall condition** list, choose **Disappear**.

#### *Image*

1 In the **Physics** toolbar, click  **Boundaries** and choose **Wall**.

2 In the **Settings** window for **Wall**, type **Image** in the **Label** text field.

3 Locate the **Boundary Selection** section. From the **Selection** list, choose **Image Plane**. The default **Wall condition** (**Freeze**) will be used.

## MESH 1

In the **Model Builder** window, under **Component 1 (comp1)** right-click **Mesh 1** and choose **Build All**. The default physics-controlled mesh settings can be used in this simulation. The mesh should look like [Figure 3](#).

## STUDY 1

### Step 1: Ray Tracing

- 1 In the **Model Builder** window, under **Study 1** click **Step 1: Ray Tracing**.
- 2 In the **Settings** window for **Ray Tracing**, locate the **Study Settings** section.
- 3 From the **Time-step specification** list, choose **Specify maximum path length**.
- 4 From the **Length unit** list, choose **mm**.
- 5 In the **Lengths** text field, type 0 200. The maximum optical path length is sufficient for rays released at large field angles to reach the image plane.
- 6 In the **Home** toolbar, click  **Compute**.

## RESULTS

In the following steps, two different ray diagrams are created, one of which uses a custom color expression. Begin by making some modifications to the default ray trajectory plot. First, define a cut plane which can be used to render the double Gauss lens cross-section.

### Cut Plane 1

In the **Results** toolbar, click  **Cut Plane**.

### Ray Diagram 1

- 1 In the **Model Builder** window, under **Results** click **Ray Trajectories (gop)**.
- 2 In the **Settings** window for **3D Plot Group**, type Ray Diagram 1 in the **Label** text field.
- 3 Locate the **Color Legend** section. Select the **Show units** check box.
- 4 From the **Position** list, choose **Bottom**.
- 5 In the **Model Builder** window, expand the **Ray Diagram 1** node.

### Filter 1

- 1 In the **Model Builder** window, expand the **Results>Ray Diagram 1>Ray Trajectories 1** node, then click **Filter 1**.
- 2 In the **Settings** window for **Filter**, locate the **Ray Selection** section.
- 3 From the **Rays to include** list, choose **Logical expression**.
- 4 In the **Logical expression for inclusion** text field, type  $at(0, abs(gop.deltaqx) < 0.1 [mm])$ . Only the sagittal rays are shown in this view.

In the following steps, the cross-section of the lens is rendered.

#### *Surface 1*

- 1 In the **Model Builder** window, right-click **Ray Diagram 1** and choose **Surface**.
- 2 In the **Settings** window for **Surface**, locate the **Data** section.
- 3 From the **Dataset** list, choose **Cut Plane 1**.
- 4 Locate the **Coloring and Style** section. From the **Coloring** list, choose **Uniform**.
- 5 From the **Color** list, choose **Gray**.

#### *Line 1*

- 1 Right-click **Ray Diagram 1** and choose **Line**.
- 2 In the **Settings** window for **Line**, locate the **Data** section.
- 3 From the **Dataset** list, choose **Cut Plane 1**.
- 4 Locate the **Coloring and Style** section. From the **Coloring** list, choose **Uniform**.
- 5 From the **Color** list, choose **Black**.
- 6 In the **Ray Diagram 1** toolbar, click  **Plot**. Compare the resulting image to [Figure 4](#).

#### *Ray Diagram 2*

For the second ray diagram the rays will be colored according to the radial distance from the ray's location in the image plane to the centroid. This makes it possible to visualize which rays are contributing to the image plane spot aberrations.

- 1 In the **Home** toolbar, click  **Add Plot Group** and choose **3D Plot Group**.
- 2 In the **Settings** window for **3D Plot Group**, type Ray Diagram 2 in the **Label** text field.
- 3 Locate the **Data** section. From the **Dataset** list, choose **Ray 1**.
- 4 Locate the **Plot Settings** section. From the **View** list, choose **New view**.
- 5 Locate the **Color Legend** section. Select the **Show units** check box.

#### *Ray Trajectories 1*

In the **Ray Diagram 2** toolbar, click  **More Plots** and choose **Ray Trajectories**.

#### *Color Expression 1*

- 1 Right-click **Ray Trajectories 1** and choose **Color Expression**.
- 2 In the **Settings** window for **Color Expression**, locate the **Expression** section.
- 3 In the **Expression** text field, type at ( 'last' ,  $\text{gop.rre1}$  ). This is the radial coordinate relative to the centroid of each release feature at the image plane.
- 4 From the **Unit** list, choose  $\mu\text{m}$ .

- 5 Locate the **Coloring and Style** section. From the **Color table** list, choose **Viridis**.



#### *Surface 1*

- 1 In the **Model Builder** window, right-click **Ray Diagram 2** and choose **Surface**.
- 2 In the **Settings** window for **Surface**, click **Replace Expression** in the upper-right corner of the **Expression** section. From the menu, choose **Component 1 (comp1)> Geometrical Optics>Refractive index>gop.nrefd - Refractive index, d-line**.
- 3 Locate the **Coloring and Style** section. From the **Color table** list, choose **GrayScale**.

#### *Selection 1*

- 1 Right-click **Surface 1** and choose **Selection**.
- 2 In the **Settings** window for **Selection**, locate the **Selection** section.
- 3 From the **Selection** list, choose **Lens Exteriors**.

#### *Transparency 1*

- 1 In the **Model Builder** window, right-click **Surface 1** and choose **Transparency**.
- 2 In the **Ray Diagram 2** toolbar, click  **Plot**.
- 3 Click the  **Orthographic Projection** button in the **Graphics** toolbar.
- 4 Click the  **Zoom Extents** button in the **Graphics** toolbar. Orient the view to match [Figure 5](#) so that the color expression in the object plane can be clearly seen.

#### *Spot Diagram*

In the following steps, a spot diagram is created.

#### *Spot Diagram*

- 1 In the **Home** toolbar, click  **Add Plot Group** and choose **2D Plot Group**.
- 2 In the **Settings** window for **2D Plot Group**, type **Spot Diagram** in the **Label** text field.
- 3 Locate the **Color Legend** section. Select the **Show units** check box.
- 4 From the **Position** list, choose **Bottom**.

#### *Spot Diagram 1*



- 1 In the **Spot Diagram** toolbar, click  **More Plots** and choose **Spot Diagram**.
- 2 In the **Settings** window for **Spot Diagram**, click to expand the **Annotations** section.
- 3 Select the **Show spot coordinates** check box.
- 4 From the **Coordinate system** list, choose **Global**. Using the **Global** coordinate system allows the  $z$  coordinate to be displayed.
- 5 In the **Display precision** text field, type 6.

### *Color Expression 1*

- 1 Right-click **Spot Diagram 1** and choose **Color Expression**.
- 2 In the **Settings** window for **Color Expression**, locate the **Expression** section.
- 3 In the **Expression** text field, type  $(0, \text{gop} . \text{rre}1)$ . This is the radial coordinate relative to the center at the location of the ray release.
- 4 Locate the **Coloring and Style** section. From the **Color table** list, choose **Viridis**.

The first spot diagram shows the intersection of the rays with the nominal image plane. This surface has been positioned so as to give the best image quality over a large range of field angles when using polychromatic light. A second spot diagram can be generated automatically on the plane which minimizes the RMS spot size for a selected field angle and wavelength.

### *Spot Diagram 2*

- 1 In the **Model Builder** window, under **Results>Spot Diagram** right-click **Spot Diagram 1** and choose **Duplicate**.
- 2 In the **Settings** window for **Spot Diagram**, click to expand the **Focal Plane Orientation** section.
- 3 From the **Normal to focal plane** list, choose **User defined**. In this model, the image plane is assumed to be tangential to the optical axis which is also the  $z$ -axis.
- 4 Click **Create Focal Plane Dataset**. This creates an **Intersection Point 3D** dataset on a Plane. In this model, which has a single on-axis field and monochromatic light, the location of the best focus plane happens to be in front of the nominal image surface. If the best focus plane lies behind the image plane, then the **Freeze** condition on the **Wall** defining the image surface should be disabled. Note that the focal plane is located about 180 microns in front of the nominal image surface.
- 5 Click to expand the **Position** section. In the **x** text field, type 0.25.
- 6 Click to expand the **Inherit Style** section. From the **Plot** list, choose **Spot Diagram 1**.
- 7 In the **Spot Diagram** toolbar, click  **Plot**.
- 8 Click the  **Zoom Extents** button in the **Graphics** toolbar. Compare the resulting image to [Figure 6](#).

### *Optical Aberration Diagram*

In the following steps, an optical aberration diagram is created.

### *Optical Aberration Diagram*

- 1 In the **Home** toolbar, click  **Add Plot Group** and choose **2D Plot Group**.





- 2 In the **Settings** window for **2D Plot Group**, type Optical Aberration Diagram in the **Label** text field.
- 3 Locate the **Color Legend** section. Select the **Show maximum and minimum values** check box.
- 4 From the **Position** list, choose **Bottom**.

#### *Optical Aberration 1*

- 1 In the **Optical Aberration Diagram** toolbar, click  **More Plots** and choose **Optical Aberration**.
- 2 In the **Settings** window for **Optical Aberration**, locate the **Focal Plane Orientation** section.
- 3 From the **Normal to focal plane** list, choose **User defined**. As with the Spot Diagram, the image plane is assumed to be tangential to the optical axis which is also the  $z$ -axis.
- 4 Click **Create Reference Hemisphere Dataset**. This creates an **Intersection Point 3D** dataset on a reference hemisphere.
- 5 Locate the **Coloring and Style** section. From the **Color table** list, choose **Dipole**.
- 6 From the **Scale** list, choose **Linear symmetric**.

#### *Optical Aberration 2*

- 1 Right-click **Optical Aberration 1** and choose **Duplicate**. Duplicate this Aberration plot so that some Zernike terms can be removed.
- 2 In the **Settings** window for **Optical Aberration**, locate the **Zernike Polynomials** section.
- 3 From the **Terms to include** list, choose **Select individual terms**.
- 4 Click **Select All**.
- 5 Clear the **Z(0,0), piston** check box.
- 6 Clear the **Z(2,0), defocus** check box. The piston and defocus terms are removed.
- 7 Locate the **Position** section. In the **x** text field, type 2.5.
- 8 Click to expand the **Inherit Style** section. From the **Plot** list, choose **Optical Aberration 1**.
- 9 In the **Optical Aberration Diagram** toolbar, click  **Plot**.
- 10 Click the  **Zoom Extents** button in the **Graphics** toolbar. Compare the resulting image to [Figure 7](#). The remaining wavefront error (about 0.6 waves) is dominated by spherical aberration.

### *Appendix — Geometry Instructions*



---

From the **File** menu, choose **New**.

## NEW

In the **New** window, click  **Model Wizard**.

## MODEL WIZARD

- 1 In the **Model Wizard** window, click .
- 2 Click  **Done**.

## GLOBAL DEFINITIONS

The detailed parameters of the lens can be imported from a text file. This lens is from [Ref. 1](#), pg 323.

### *Parameters 1*

- 1 In the **Model Builder** window, under **Global Definitions** click **Parameters 1**.
- 2 In the **Settings** window for **Parameters**, locate the **Parameters** section.
- 3 Click  **Load from File**.
- 4 Browse to the model's Application Libraries folder and double-click the file `double_gauss_lens_geom_sequence_parameters.txt`.

### *Double Gauss Lens Parameters*

The parameters that define the Double Gauss Lens geometry sequence are found in `double_gauss_lens_geom_sequence_parameters.txt`. These will be described in the tables below.

- 1 First, define the global optical axis. This is used to orient the first lens only. The orientation of each subsequent lens will be relative to the preceding one.

Parameter	Description
<code>nix</code>	Global optical axis, x-component
<code>niy</code>	Global optical axis, y-component
<code>niz</code>	Global optical axis, z-component

- 2 Next, define the parameters for each of the lens elements. Each lens requires 8 parameters in addition to the local optical axis definition (which, by convention, is coincident with the local  $z$ -axis).

Parameter	Description
<code>R1_[n]</code>	Radius of curvature, surface 1, lens [n]
<code>R2_[n]</code>	Radius of curvature, surface 2, lens [n]
<code>Tc_[n]</code>	Center thickness, lens [n]

Parameter	Description
d0_[n]	Outer diameter, lens [n]
d1_[n]	Diameter, surface 1, lens [n]
d2_[n]	Diameter, surface 2, lens [n]
d1_clear_[n]	Clear aperture diameter, surface 1, lens [n]
d2_clear_[n]	Clear aperture diameter, surface 2, lens [n]

3 Finally, define the remaining lens parameters.

Parameter	Description
T_[n]	Distance between lens elements [n] and [n+1].
d0_S	Stop maximum (outer) diameter
d1_S	Stop minimum (clear) diameter
d0_D	Diameter of image plane



### DOUBLE GAUSS LENS GEOMETRY SEQUENCE

Start constructing the lens geometry.

- 1 In the **Model Builder** window, under **Component 1 (comp1)** click **Geometry 1**.
- 2 In the **Settings** window for **Geometry**, type Double Gauss Lens Geometry Sequence in the **Label** text field.
- 3 Locate the **Units** section. From the **Length unit** list, choose **mm**.





Insert the first of the Double Gauss Lens elements.

### PART LIBRARIES

- 1 In the **Home** toolbar, click  **Windows** and choose **Part Libraries**.
- 2 In the **Part Libraries** window, select **Ray Optics Module>3D>Spherical Lenses>spherical\_lens\_3d** in the tree.
- 3 Click  **Add to Geometry**.
- 4 In the **Select Part Variant** dialog box, select **Specify clear aperture diameter** in the **Select part variant** list.
- 5 Click **OK**. This part is used for each of the 6 Double Gauss Lens elements.

## DOUBLE GAUSS LENS GEOMETRY SEQUENCE

### *Lens 1*

- 1 In the **Model Builder** window, under **Component 1 (comp1)> Double Gauss Lens Geometry Sequence** click **Spherical Lens 3D 1 (pi1)**.
- 2 In the **Settings** window for **Part Instance**, type Lens 1 in the **Label** text field.
- 3 Locate the **Input Parameters** section. Click  **Load from File**.
- 4 Browse to the model's Application Libraries folder and double-click the file `double_gauss_lens_geom_sequence_lens1.txt`. The file `double_gauss_lens_geom_sequence_lens[m,m=1..6].txt` contains references to each of the individual lens parameters. This avoids having to enter the values manually.
- 5 Click  **Build Selected**.
- 6 Click the  **Orthographic Projection** button in the **Graphics** toolbar.
- 7 In the **Graphics** window toolbar, click  next to  **Go to Default View**, then choose **Go to ZY View**. Switch the view to orthographic, and orientate the view to place the optical axis ( $z$ -axis) horizontal and the  $y$ -axis vertical.

Create cumulative selections defining the materials, clear apertures, obstructions and image plane that can be used within the final ray trace.

### *Cumulative Selections*

In the **Geometry** toolbar, click  **Selections** and choose **Cumulative Selections**.

### *Lens Material 1*

- 1 Right-click **Cumulative Selections** and choose **Cumulative Selection**.
- 2 In the **Settings** window for **Selection**, type Lens Material 1 in the **Label** text field.

### *Lens Material 2*

- 1 In the **Model Builder** window, right-click **Cumulative Selections** and choose **Cumulative Selection**.
- 2 In the **Settings** window for **Selection**, type Lens Material 2 in the **Label** text field. In the same manner, add selections for Lens Material 3, Clear Apertures, Obstructions, Aperture Stop, and Image Plane.

### *Lens 1 (pi1)*

Now, apply these selections.

- 1 In the **Model Builder** window, under **Component 1 (comp1)> Double Gauss Lens Geometry Sequence** click **Lens 1 (pi1)**.
- 2 In the **Settings** window for **Part Instance**, click to expand the **Domain Selections** section.

3 In the table, enter the following settings:



Name	Keep	Physics	Contribute to
All		√	Lens Material 1

4 Click to expand the **Boundary Selections** section. In the table, enter the following settings:

Name	Keep	Physics	Contribute to
Exterior		√	Lens Exteriors
Surface 1		√	Clear Apertures
Surface 2		√	Clear Apertures
Surface 1 obstruction		√	Obstructions
Surface 2 obstruction		√	Obstructions
Edges		√	Obstructions

### Lens 2

Continue constructing the lens. Add the second lens element.

- 1 In the **Geometry** toolbar, click  **Parts** and choose **Spherical Lens 3D**.
- 2 In the **Settings** window for **Part Instance**, type Lens 2 in the **Label** text field.
- 3 Locate the **Input Parameters** section. Click  **Load from File**.
- 4 Browse to the model's Application Libraries folder and double-click the file `double_gauss_lens_geom_sequence_lens2.txt`.  
Each lens element can be positioned in the geometry by referencing it to an existing work plane. For this example, use a work plane that is defined by the intersection of a plane tangential to the optical axis with the vertex on the exit surface of the preceding lens element.
- 5 Locate the **Position and Orientation of Output** section. Find the **Coordinate system to match** subsection. From the **Take work plane from** list, choose **Lens 1 (pi1)**.
- 6 From the **Work plane** list, choose **Surface 2 vertex intersection (wp2)**.
- 7 Find the **Displacement** subsection. In the **zw** text field, type `T_1`. This is the distance along the optical axis between the vertex on the exit surface of lens 1 and the vertex on the entrance surface of lens 2.

8 Locate the **Domain Selections** section. In the table, enter the following settings:



Name	Keep	Physics	Contribute to
All		√	Lens Material 2

9 Locate the **Boundary Selections** section. In the table, enter the following settings:

Name	Keep	Physics	Contribute to
Exterior		√	Lens Exteriors
Surface 1		√	Clear Apertures
Surface 2		√	Clear Apertures
Surface 1 obstruction		√	Obstructions
Surface 2 obstruction		√	Obstructions
Edges		√	Obstructions

### Lens 3

The remaining lenses are similarly defined. Next, add the third lens element.

- 1 In the **Geometry** toolbar, click  **Parts** and choose **Spherical Lens 3D**.
- 2 In the **Settings** window for **Part Instance**, type Lens 3 in the **Label** text field.
- 3 Locate the **Input Parameters** section. Click  **Load from File**.
- 4 Browse to the model's Application Libraries folder and double-click the file double\_gauss\_lens\_geom\_sequence\_lens3.txt.
- 5 Locate the **Position and Orientation of Output** section. Find the **Coordinate system to match** subsection. From the **Take work plane from** list, choose **Lens 2 (pi2)**.
- 6 From the **Work plane** list, choose **Surface 2 vertex intersection (wp2)**.
- 7 Find the **Displacement** subsection. In the **zw** text field, type T\_2.
- 8 Locate the **Domain Selections** section. In the table, enter the following settings:

Name	Keep	Physics	Contribute to
All		√	Lens Material 3



9 Locate the **Boundary Selections** section. In the table, enter the following settings:

Name	Keep	Physics	Contribute to
Exterior		√	Lens Exteriors
Surface 1		√	Clear Apertures

Name	Keep	Physics	Contribute to
Surface 2		√	Clear Apertures
Surface 1 obstruction		√	Obstructions
Surface 2 obstruction		√	Obstructions
Edges		√	Obstructions

### PART LIBRARIES

Next, insert the aperture stop.

- 1 In the **Geometry** toolbar, click  **Parts** and choose **Part Libraries**.
- 2 In the **Part Libraries** window, select **Ray Optics Module>3D>Apertures and Obstructions>circular\_planar\_annulus** in the tree.
- 3 Click  **Add to Geometry**. This part is also used to define the image plane and additional obstructions.

### DOUBLE GAUSS LENS GEOMETRY SEQUENCE

Stop

- 1 In the **Model Builder** window, under **Component 1 (comp1)>Double Gauss Lens Geometry Sequence** click **Circular Planar Annulus 1 (pi4)**.
- 2 In the **Settings** window for **Part Instance**, type Stop in the **Label** text field.
- 3 Locate the **Input Parameters** section. In the table, enter the following settings:

Name	Expression	Value	Description
d0	d0_S	60 mm	Diameter, outer
d1	d1_S	37.2 mm	Diameter, inner
nix	0	0	Local optical axis, x-component
niy	0	0	Local optical axis, y-component
niz	1	1	Local optical axis, z-component



- 4 Locate the **Position and Orientation of Output** section. Find the **Coordinate system to match** subsection. From the **Take work plane from** list, choose **Lens 3 (pi3)**.
- 5 From the **Work plane** list, choose **Surface 2 vertex intersection (wp2)**.
- 6 Find the **Displacement** subsection. In the **zw** text field, type T\_3+Tc\_4.

7 Locate the **Boundary Selections** section. In the table, enter the following settings:

Name	Keep	Physics	Contribute to
All		√	Aperture Stop

#### Lens 4

Next, add the fourth lens element.

- 1 In the **Geometry** toolbar, click  **Parts** and choose **Spherical Lens 3D**.
- 2 In the **Settings** window for **Part Instance**, type Lens 4 in the **Label** text field.
- 3 Locate the **Input Parameters** section. Click  **Load from File**.
- 4 Browse to the model's Application Libraries folder and double-click the file double\_gauss\_lens\_geom\_sequence\_lens4.txt.
- 5 Locate the **Position and Orientation of Output** section. Find the **Coordinate system to match** subsection. From the **Take work plane from** list, choose **Stop (pi4)**.
- 6 From the **Work plane** list, choose **Surface (wp1)**.
- 7 Find the **Displacement** subsection. In the **zw** text field, type T\_4.
- 8 Locate the **Domain Selections** section. In the table, enter the following settings:

Name	Keep	Physics	Contribute to
All		√	Lens Material 3

9 Locate the **Boundary Selections** section. In the table, enter the following settings:

Name	Keep	Physics	Contribute to
Exterior		√	Lens Exteriors
Surface 1		√	Clear Apertures
Surface 2		√	Clear Apertures
Surface 1 obstruction		√	Obstructions
Surface 2 obstruction		√	Obstructions
Edges		√	Obstructions

#### Lens 5

Next, add the fifth lens element.

- 1 In the **Geometry** toolbar, click  **Parts** and choose **Spherical Lens 3D**.
- 2 In the **Settings** window for **Part Instance**, type Lens 5 in the **Label** text field.



- 3 Locate the **Input Parameters** section. Click  **Load from File**.
- 4 Browse to the model's Application Libraries folder and double-click the file `double_gauss_lens_geom_sequence_lens5.txt`.
- 5 Locate the **Position and Orientation of Output** section. Find the **Coordinate system to match** subsection. From the **Take work plane from** list, choose **Lens 4 (pi5)**.
- 6 From the **Work plane** list, choose **Surface 2 vertex intersection (wp2)**.
- 7 Find the **Displacement** subsection. In the **zw** text field, type `T_5`.
- 8 Locate the **Domain Selections** section. In the table, enter the following settings:



Name	Keep	Physics	Contribute to
All		√	Lens Material I

- 9 Locate the **Boundary Selections** section. In the table, enter the following settings:

Name	Keep	Physics	Contribute to
Exterior		√	Lens Exteriors
Surface 1		√	Clear Apertures
Surface 2		√	Clear Apertures
Surface 1 obstruction		√	Obstructions
Surface 2 obstruction		√	Obstructions
Edges		√	Obstructions

### Lens 6

Add the final (sixth) lens element.

- 1 In the **Geometry** toolbar, click  **Parts** and choose **Spherical Lens 3D**.
- 2 In the **Settings** window for **Part Instance**, type `Lens_6` in the **Label** text field.
- 3 Locate the **Input Parameters** section. Click  **Load from File**.
- 4 Browse to the model's Application Libraries folder and double-click the file `double_gauss_lens_geom_sequence_lens6.txt`.
- 5 Locate the **Position and Orientation of Output** section. Find the **Coordinate system to match** subsection. From the **Take work plane from** list, choose **Lens 5 (pi6)**.
- 6 From the **Work plane** list, choose **Surface 2 vertex intersection (wp2)**.
- 7 Find the **Displacement** subsection. In the **zw** text field, type `T_6`.

8 Locate the **Domain Selections** section. In the table, enter the following settings:

Name	Keep	Physics	Contribute to
All		√	Lens Material 2

9 Locate the **Boundary Selections** section. In the table, enter the following settings:

Name	Keep	Physics	Contribute to
Exterior		√	Lens Exteriors
Surface 1		√	Clear Apertures
Surface 2		√	Clear Apertures
Surface 1 obstruction		√	Obstructions
Surface 2 obstruction		√	Obstructions
Edges		√	Obstructions

### Image



Now, add a surface to define the image plane.

- 1 In the **Geometry** toolbar, click  **Parts** and choose **Circular Planar Annulus**.
- 2 In the **Settings** window for **Part Instance**, type Image in the **Label** text field.
- 3 Locate the **Input Parameters** section. In the table, enter the following settings:

Name	Expression	Value	Description
d0	d0_D	85 mm	Diameter, outer
d1	0	0 m	Diameter, inner
nix	0	0	Local optical axis, x-component
niy	0	0	Local optical axis, y-component
niz	1	1	Local optical axis, z-component

- 4 Locate the **Position and Orientation of Output** section. Find the **Coordinate system to match** subsection. From the **Take work plane from** list, choose **Lens 6 (pi7)**.
- 5 From the **Work plane** list, choose **Surface 2 vertex intersection (wp2)**.
- 6 Find the **Displacement** subsection. In the **zw** text field, type T\_7.
- 7 Locate the **Boundary Selections** section. In the table, enter the following settings:

Name	Keep	Physics	Contribute to
All		√	Image Plane

- 8 Click  **Build All Objects**.
- 9 Click the  **Zoom Extents** button in the **Graphics** toolbar. Compare the resulting image to [Figure 2](#).

