

# SAR of a Human Head Next to a Wi-Fi Antenna

## Introduction

---

Users of consumer electronics with radiating devices are exposed to radio frequency (RF) emission. The amount of exposure is defined as the specific absorption rate (SAR). That is, the SAR value represents the radio frequency (RF) energy rate absorbed by a body. This model computes local SAR values over a simplified human head and brain mock-up when a microstrip patch antenna operating in the Wi-Fi frequency range is placed close to the head.

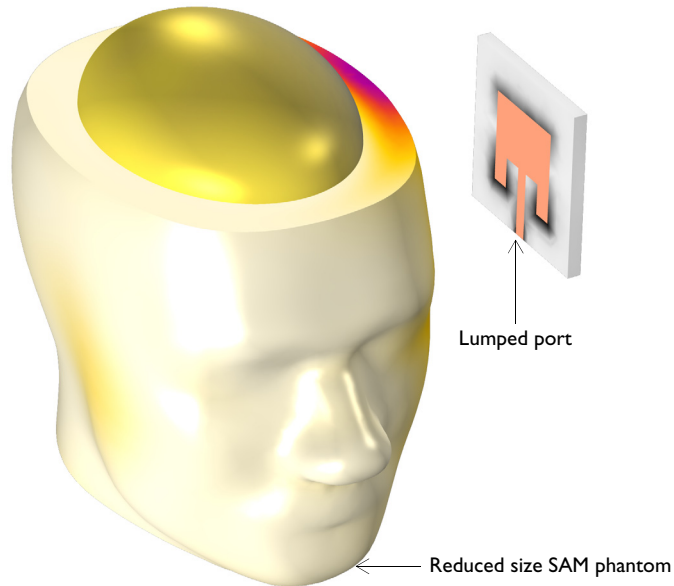

*Figure 1: Human head phantom next to a microstrip patch antenna resonant around the Wi-Fi frequency range. The surrounding air domain and perfectly matched layer are removed from the figure for visualization purposes.*

## Model Definition

---

The human head geometry is the same as the specific anthropomorphic mannequin (SAM) phantom provided by IEEE, IEC, and CENELEC from their standard specification of SAR value measurements. The geometry is imported into COMSOL Multiphysics after minor adjustments and scaling down to 60 % of the original geometry to reduce the problem size. The shape of brain is simplified using an ellipsoid geometry. This model

takes material properties for the human brain from a presentation by [Ref. 1](#). The following table shows some important properties from this publication at 2.45 GHz.

PARAMETER	VALUE	DESCRIPTION
$\sigma$	2.09 S/m	Conductivity
$\epsilon_r$	54.7	Relative permittivity

Other parts of the human head is characterized using the properties of cortical bone tissue ([Ref. 2](#)), as displayed below.

PARAMETER	VALUE	DESCRIPTION
$\sigma$	0.4 S/m	Conductivity
$\epsilon_r$	11.35	Relative permittivity

This example is an introductory model showing how to analyze SAR. It is assumed here that all materials are homogeneous, which is an oversimplification. For more realistic brain material characterization, see another application library example, [Specific Absorption Rate \(SAR\) in the Human Brain](#) in which material parameters based on the imported MRI image data with a volumetric interpolation function characterize the variation of tissue type inside the head.

The microstrip patch antenna next to the human head is composed of a thin layer of metal, a rectangular FR4 dielectric block, and a ground plane. The microstrip feed line, antenna radiator and ground plane are modeled as perfect electric conductor (PEC) surfaces. The antenna is fed by a 50  $\Omega$  lumped port, representing a feed from the power source.

The human head phantom and antenna are enclosed by a spherical air domain which is truncated by perfectly matched layers. This mimics the antenna testing in infinite free space. The perfectly matched layers work like an anechoic chamber in reality preventing unwanted reflection from the outer walls.

### *Results and Discussion*

---

The model simulates the local SAR values in the head under effect of the RF emission caused by a microstrip patch antenna resonant in the Wi-Fi frequency range. The highest SAR value is observed in the mock-up brain area close to the surface of the head facing the incident electric field.

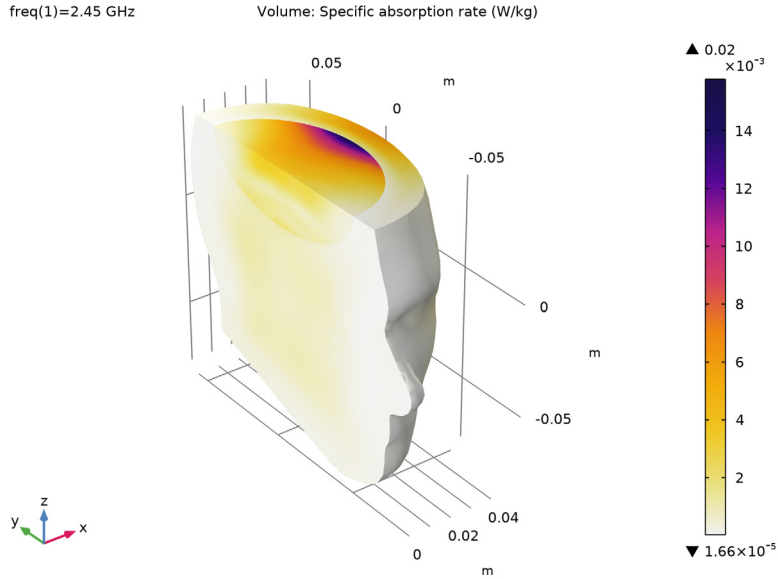

*Figure 2: The computed local SAR values are visualized for a part of the head using a filter subfeature. The brain part closest to the radiating antenna has the highest SAR values.*

## References

1. G. Schmid, G. Neubauer, and P.R. Mazal, “Dielectric properties of human brain tissue measured less than 10 h postmortem at frequencies from 800 to 2450 MHz,” *Bioelectromagnetics*, vol. 24, pp 423–430, 2003.
2. M. Vallejo and others, “Accurate Human Tissue Characterization for Energy-Efficient Wireless On-Body Communications,” *Sensors*, vol. 13, pp. 7546–7569, 2013.

---

**Application Library path:** RF\_Module/EMI EMC\_Applications/sar\_wifi\_antenna

---

## *Modeling Instructions*



---

From the **File** menu, choose **New**.

### **NEW**

In the **New** window, click  **Model Wizard**.

### **MODEL WIZARD**

- 1 In the **Model Wizard** window, click .
- 2 In the **Select Physics** tree, select **Radio Frequency>Electromagnetic Waves, Frequency Domain (emw)**.
- 3 Click **Add**.
- 4 Click  **Study**.
- 5 In the **Select Study** tree, select **General Studies>Frequency Domain**.
- 6 Click  **Done**.

### **STUDY I**



*Step 1: Frequency Domain*

- 1 In the **Model Builder** window, under **Study I** click **Step 1: Frequency Domain**.
- 2 In the **Settings** window for **Frequency Domain**, locate the **Study Settings** section.
- 3 In the **Frequencies** text field, type 2.45[GHz].

### **GEOMETRY I**

The head geometry has been created outside COMSOL Multiphysics, so you import it from an MPHBIN-file. Then create the PML, air, simplified brain, and antenna domains manually.

*Import I (impl)*

- 1 In the **Home** toolbar, click  **Import**.
- 2 In the **Settings** window for **Import**, locate the **Import** section.
- 3 Click  **Browse**.
- 4 Browse to the model's Application Libraries folder and double-click the file sar\_wifi\_antenna.mphbin.

5 Click  **Import**.

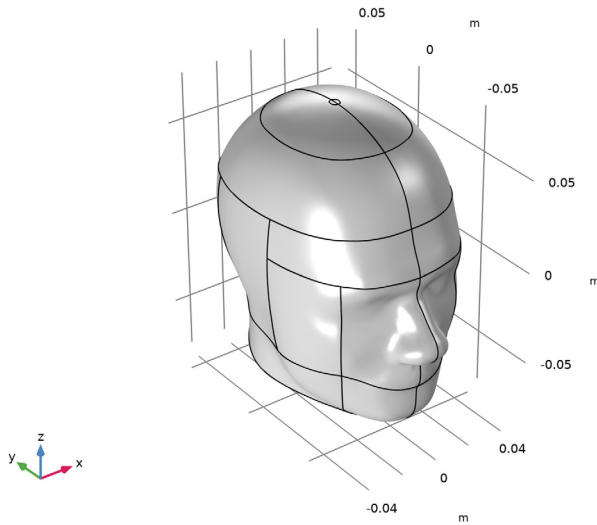

6 Click the  **Wireframe Rendering** button in the **Graphics** toolbar.

Add a simplified brain domain using an ellipsoid.

*Ellipsoid 1 (elp1)*

1 In the **Geometry** toolbar, click  **More Primitives** and choose **Ellipsoid**.

2 In the **Settings** window for **Ellipsoid**, locate the **Size and Shape** section.

3 In the **a-semiaxis** text field, type 0.035.

4 In the **b-semiaxis** text field, type 0.045.

5 In the **c-semiaxis** text field, type 0.025.

6 Locate the **Position** section. In the **y** text field, type -0.005.

7 In the **z** text field, type 0.04.

Build a geometry for a microstrip patch antenna operating in the Wi-Fi frequency range.

*Block 1 (blk1)*

1 In the **Geometry** toolbar, click  **Block**.

2 In the **Settings** window for **Block**, locate the **Size and Shape** section.

3 In the **Width** text field, type 0.004.

4 In the **Depth** text field, type 0.05.

5 In the **Height** text field, type 0.05.

- 6 Locate the **Position** section. From the **Base** list, choose **Center**.
- 7 In the **x** text field, type 0.10.

*Work Plane 1 (wp1)*

- 1 In the **Geometry** toolbar, click  **Work Plane**.
- 2 In the **Settings** window for **Work Plane**, locate the **Plane Definition** section.
- 3 From the **Plane type** list, choose **Face parallel**.
- 4 On the object **blk1**, select Boundary 2 only.

*Work Plane 1 (wp1)>Plane Geometry*

In the **Model Builder** window, click **Plane Geometry**.

*Work Plane 1 (wp1)>Square 1 (sq1)*

- 1 In the **Work Plane** toolbar, click  **Square**.
- 2 In the **Settings** window for **Square**, locate the **Size** section.
- 3 In the **Side length** text field, type 0.0275.
- 4 Locate the **Position** section. From the **Base** list, choose **Center**.

*Work Plane 1 (wp1)>Rectangle 1 (r1)*

- 1 In the **Work Plane** toolbar, click  **Rectangle**.
- 2 In the **Settings** window for **Rectangle**, locate the **Size and Shape** section.
- 3 In the **Width** text field, type 0.0039.
- 4 In the **Height** text field, type 0.01125.
- 5 Locate the **Position** section. From the **Base** list, choose **Center**.
- 6 In the **yw** text field, type 0.019375.

*Work Plane 1 (wp1)>Union 1 (uni1)*

- 1 In the **Work Plane** toolbar, click  **Booleans and Partitions** and choose **Union**.
- 2 Click in the **Graphics** window and then press Ctrl+A to select both objects.
- 3 In the **Settings** window for **Union**, locate the **Union** section.
- 4 Clear the **Keep interior boundaries** check box.

*Work Plane 1 (wp1)>Rectangle 2 (r2)*



- 1 In the **Work Plane** toolbar, click  **Rectangle**.
- 2 In the **Settings** window for **Rectangle**, locate the **Size and Shape** section.
- 3 In the **Width** text field, type 0.006.
- 4 In the **Height** text field, type 0.00925.

- 5 Locate the **Position** section. In the **xw** text field, type 0.00195.
- 6 In the **yw** text field, type 0.0045.

*Work Plane 1 (wp1)>Mirror 1 (mir1)*

- 1 In the **Work Plane** toolbar, click  **Transforms** and choose **Mirror**.
- 2 Select the object **r2** only.
- 3 In the **Settings** window for **Mirror**, locate the **Input** section.
- 4 Select the **Keep input objects** check box.

*Work Plane 1 (wp1)>Difference 1 (dif1)*

- 1 In the **Work Plane** toolbar, click  **Booleans and Partitions** and choose **Difference**.
- 2 Select the object **uni1** only.
- 3 In the **Settings** window for **Difference**, locate the **Difference** section.
- 4 Find the **Objects to subtract** subsection. Click to select the  **Activate Selection** toggle button.
- 5 Select the objects **mir1** and **r2** only.
- 6 Click  **Build Selected**.

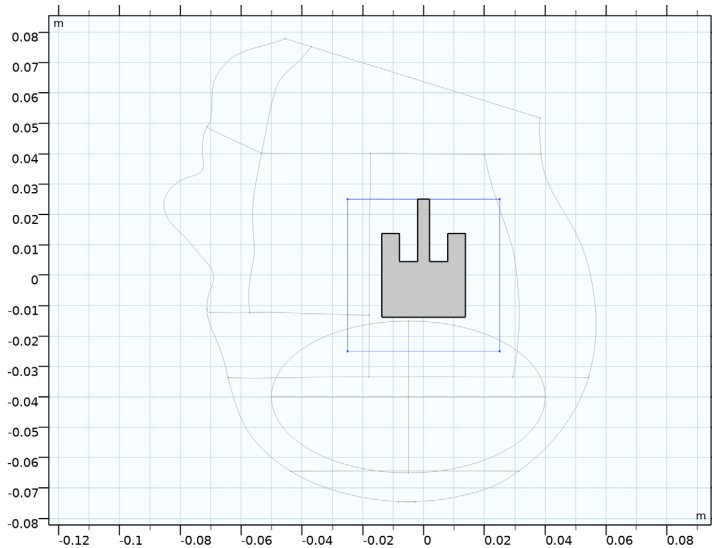

*Work Plane 2 (wp2)*

- 1 In the **Model Builder** window, right-click **Geometry 1** and choose **Work Plane**.
- 2 In the **Settings** window for **Work Plane**, locate the **Plane Definition** section.





- 3 From the **Plane type** list, choose **Face parallel**.
- 4 On the object **blk1**, select Boundary 1 only.

*Work Plane 2 (wp2)>Plane Geometry*

In the **Model Builder** window, click **Plane Geometry**.

*Work Plane 2 (wp2)>Rectangle 1 (r1)*

- 1 In the **Work Plane** toolbar, click  **Rectangle**.
- 2 In the **Settings** window for **Rectangle**, locate the **Size and Shape** section.
- 3 In the **Width** text field, type 0.004.
- 4 In the **Height** text field, type 0.0039.
- 5 Locate the **Position** section. From the **Base** list, choose **Center**.
- 6 Click  **Build Selected**.

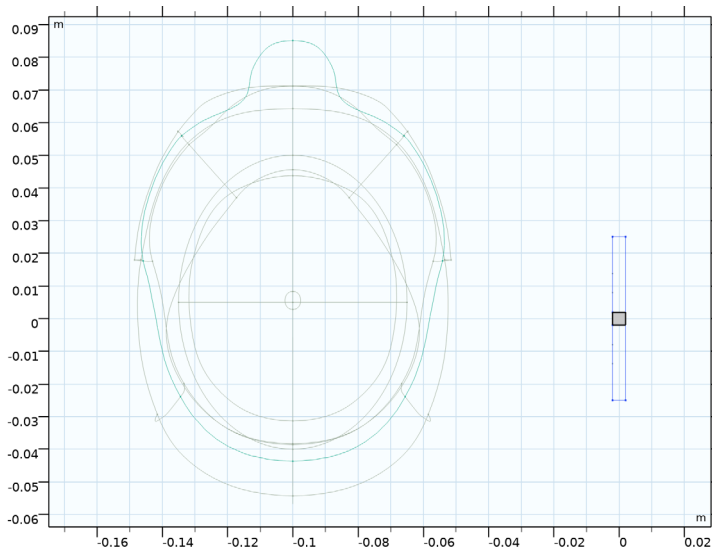

A lumped port will be set to this boundary.

- 7 Click the  **Zoom Extends** button in the **Graphics** toolbar.

*Sphere 1 (sph1)*

- 1 In the **Geometry** toolbar, click  **Sphere**.
- 2 In the **Settings** window for **Sphere**, locate the **Size** section.
- 3 In the **Radius** text field, type 0.18.

4 Click to expand the **Layers** section. In the table, enter the following settings:

Layer name	Thickness (m)
Layer 1	0.05

In this layer, a perfectly matched layer will be assigned.

5 In the **Geometry** toolbar, click  **Build All**.

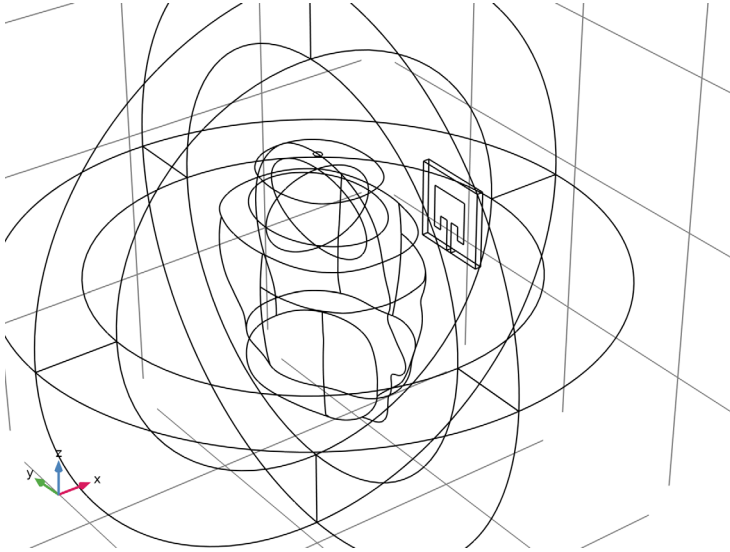

## DEFINITIONS

*Perfectly Matched Layer 1 (pml1)*

1 In the **Definitions** toolbar, click  **Perfectly Matched Layer**.

2 Select Domains 1–4 and 8–11 only.

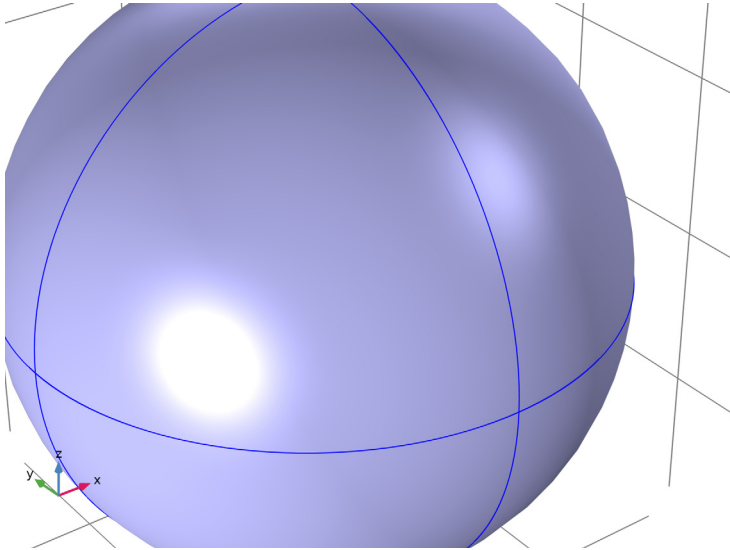

3 In the **Settings** window for **Perfectly Matched Layer**, locate the **Geometry** section.

4 From the **Type** list, choose **Spherical**.

## **ELECTROMAGNETIC WAVES, FREQUENCY DOMAIN (EMW)**

### *Perfect Electric Conductor 2*

1 In the **Model Builder** window, under **Component 1 (comp1)** right-click **Electromagnetic Waves, Frequency Domain (emw)** and choose **Perfect Electric Conductor**.

2 Select Boundaries 62 and 66 only.

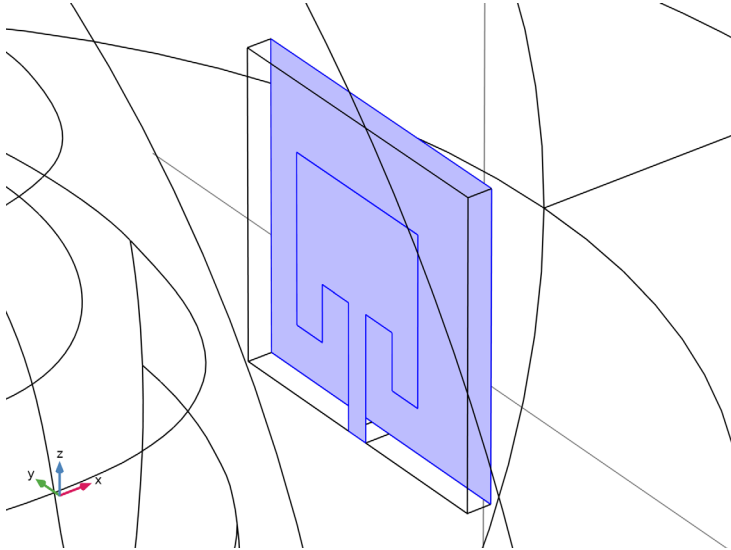

The metal parts of the antenna substrate are defined as perfect electric conductors, assuming that the conductivity of copper is high enough to have negligible loss.

*Lumped Port 1*

1 In the **Physics** toolbar, click  **Boundaries** and choose **Lumped Port**.

2 Select Boundary 63 only.

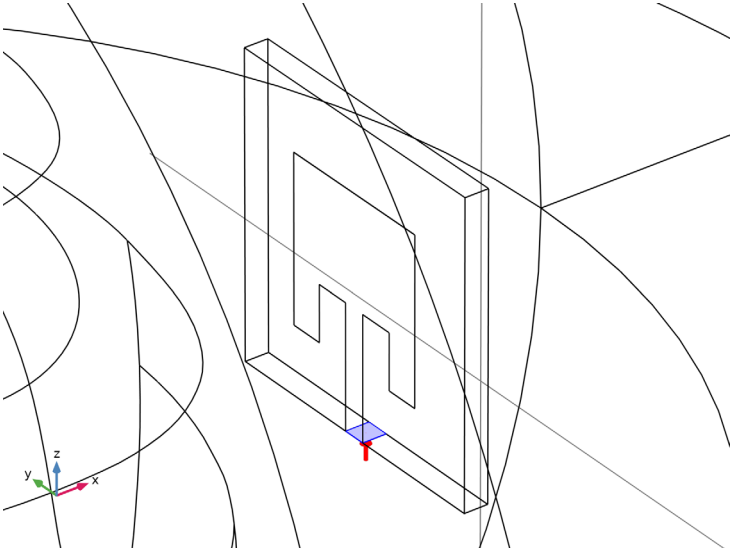

*Far-Field Domain 1*

1 In the **Physics** toolbar, click  **Domains** and choose **Far-Field Domain**.

2 Select Domain 5 only.

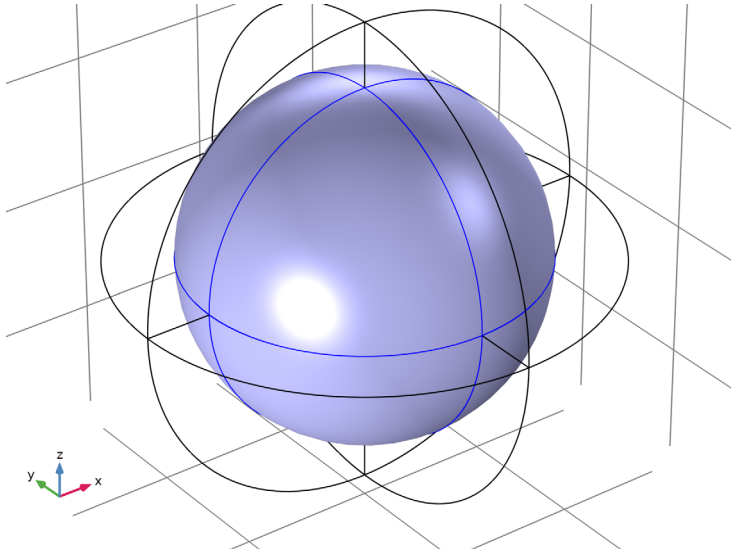

The **Far-Field Domain** feature defines a wave number for use by its subfeature - the **Far-Field Calculation** feature.

*Specific Absorption Rate 1*

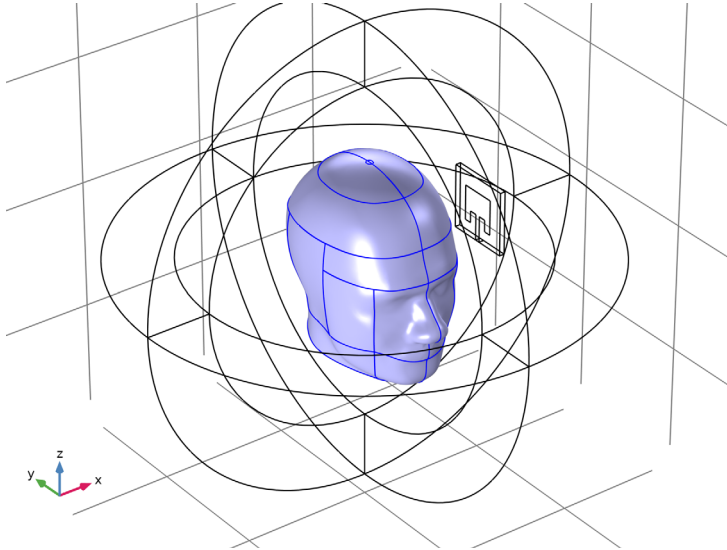

1 In the **Physics** toolbar, click  **Domains** and choose **Specific Absorption Rate**.

2 Select Domains 6 and 7 only.



The specific absorption rate feature defines the SAR postprocessing variable. It is calculated from the electromagnetic dissipation density and the specified density for the human head.

#### ADD MATERIAL

- 1 In the **Home** toolbar, click  **Add Material** to open the **Add Material** window.
- 2 Go to the **Add Material** window.
- 3 In the tree, select **Built-in>Air**.
- 4 Click **Add to Component** in the window toolbar.
- 5 In the tree, select **Built-in>FR4 (Circuit Board)**.
- 6 Click **Add to Component** in the window toolbar.
- 7 In the **Home** toolbar, click  **Add Material** to close the **Add Material** window.

## MATERIALS

FR4 (Circuit Board) (mat2)

Select Domain 12 only.

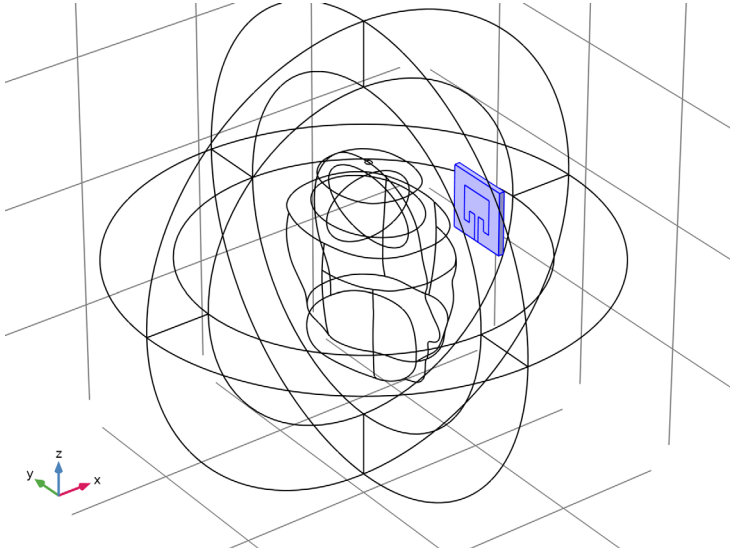

Brain

- 1 In the **Model Builder** window, right-click **Materials** and choose **Blank Material**.
- 2 In the **Settings** window for **Material**, type Brain in the **Label** text field.



3 Select Domain 7 only.

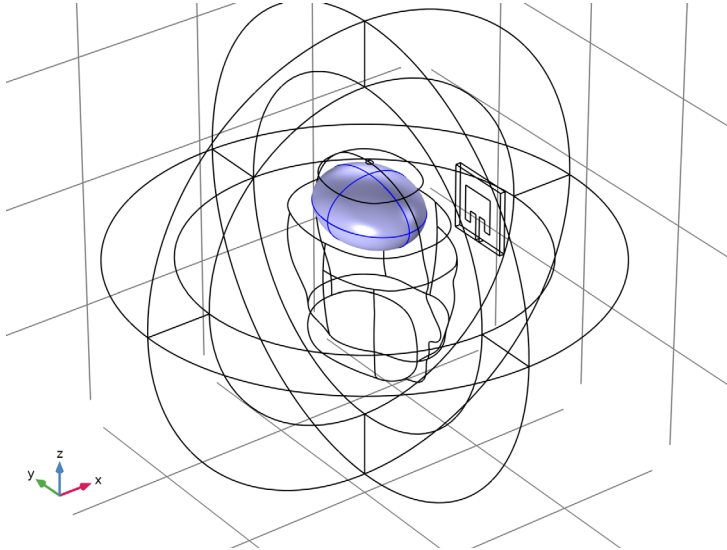

4 Locate the **Material Contents** section. In the table, enter the following settings:

Property	Variable	Value	Unit	Property group
Relative permittivity	epsilon_r_iso ; epsilon_r_ii = epsilon_r_iso, epsilon_r_ij = 0	54.7	l	Basic
Relative permeability	mu_r_iso ; mu_r_ii = mu_r_iso, mu_r_ij = 0	1	l	Basic
Electrical conductivity	sigma_iso ; sigma_ii = sigma_iso, sigma_ij = 0	2.09	S/m	Basic
Density	rho	1000	kg/m <sup>3</sup>	Basic

*Head*

1 Right-click **Materials** and choose **Blank Material**.

2 In the **Settings** window for **Material**, type **Head** in the **Label** text field.

3 Select Domain 6 only.

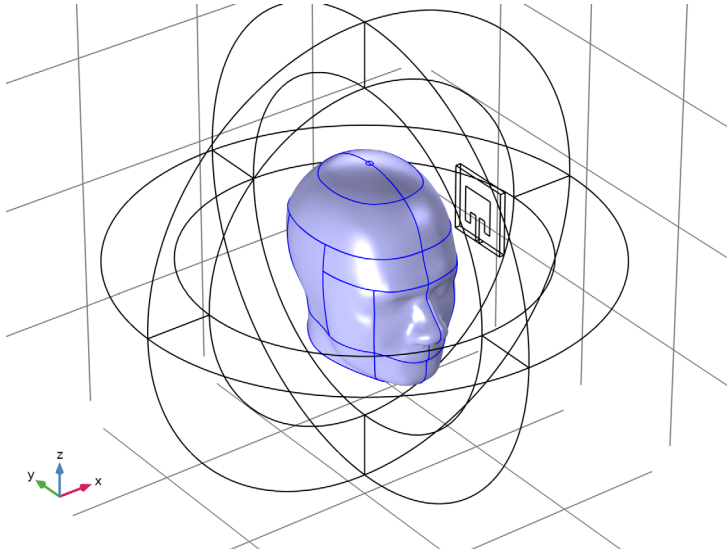

4 Locate the **Material Contents** section. In the table, enter the following settings:

Property	Variable	Value	Unit	Property group
Relative permittivity	epsilon_r_iso ; epsilon_r_ii = epsilon_r_iso, epsilon_r_ij = 0	11.35	l	Basic
Relative permeability	mu_r_iso ; mu_r_ii = mu_r_iso, mu_r_ij = 0	1	l	Basic
Electrical conductivity	sigma_iso ; sigma_ii = sigma_iso, sigma_ij = 0	0.4	S/m	Basic
Density	rho	2000	kg/m <sup>3</sup>	Basic

## DEFINITIONS

### View 1

Some domains and boundaries can be removed from the view. This may help when inspecting the mesh quality.

### *Hide for Physics 1*

- 1 In the **Model Builder** window, right-click **View 1** and choose **Hide for Physics**.
- 2 Select Domains 1, 2, 8, and 9 only.

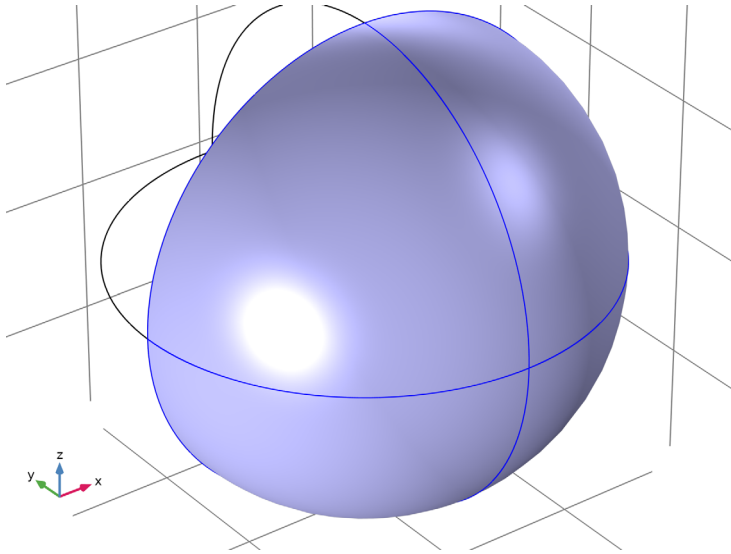

### *Hide for Physics 2*

- 1 Right-click **View 1** and choose **Hide for Physics**.
- 2 In the **Settings** window for **Hide for Physics**, locate the **Geometric Entity Selection** section.
- 3 From the **Geometric entity level** list, choose **Boundary**.
- 4 Click  **Paste Selection**.
- 5 In the **Paste Selection** dialog box, type 9, 10, 13-16, 39, 40 in the **Selection** text field.

6 Click OK.

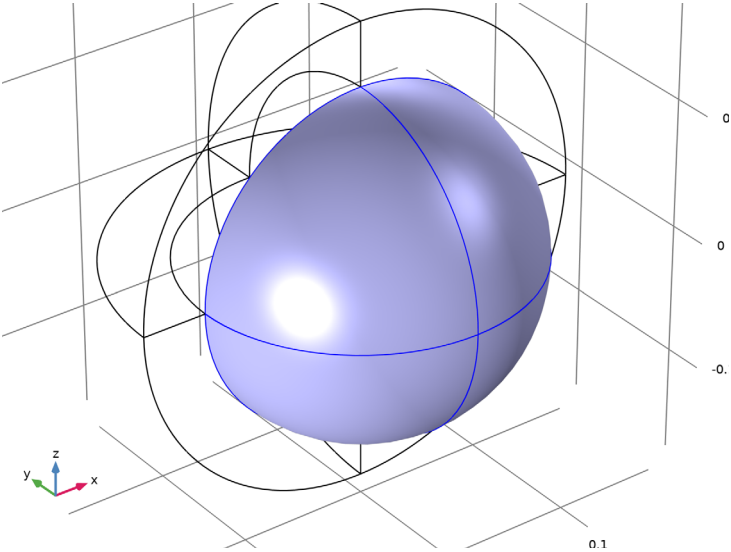

## MESH 1

- 1 In the **Model Builder** window, under **Component 1 (comp1)** right-click **Mesh 1** and choose **Build All**.

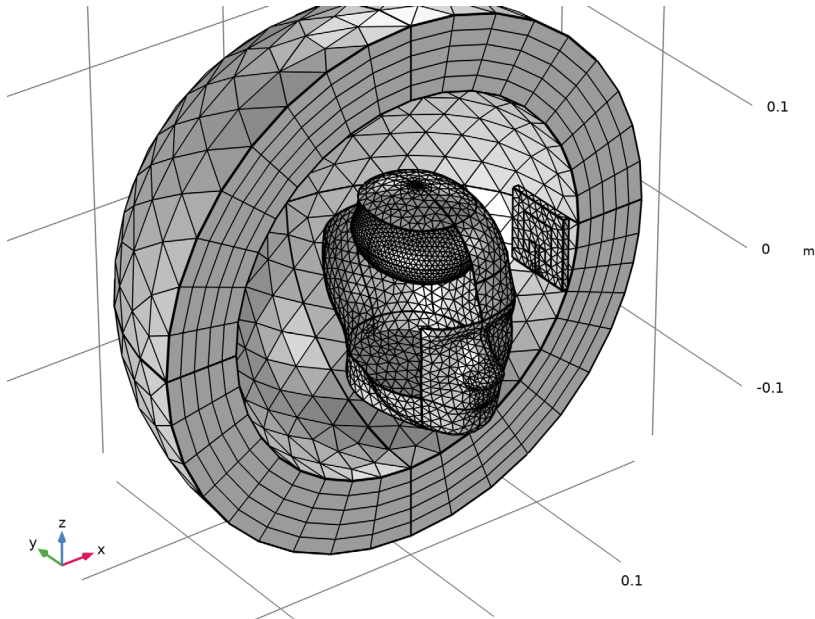

- 2 In the **Home** toolbar, click  **Compute**.

## RESULTS

### *Multislice*

- 1 In the **Model Builder** window, expand the **Results>Electric Field (emw)** node, then click **Multislice**.
- 2 In the **Settings** window for **Multislice**, locate the **Multipane Data** section.
- 3 Find the **Y-planes** subsection. In the **Planes** text field, type 0.
- 4 Find the **Z-planes** subsection. In the **Planes** text field, type 0.
- 5 Locate the **Coloring and Style** section. From the **Color table** list, choose **HeatCamera**.

6 From the **Color table transformation** list, choose **Reverse**.

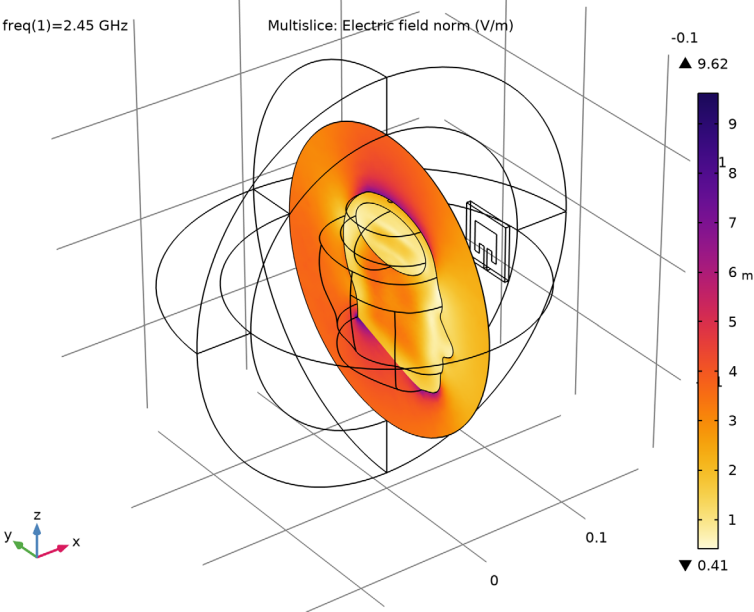

## 2D Far Field (emw)

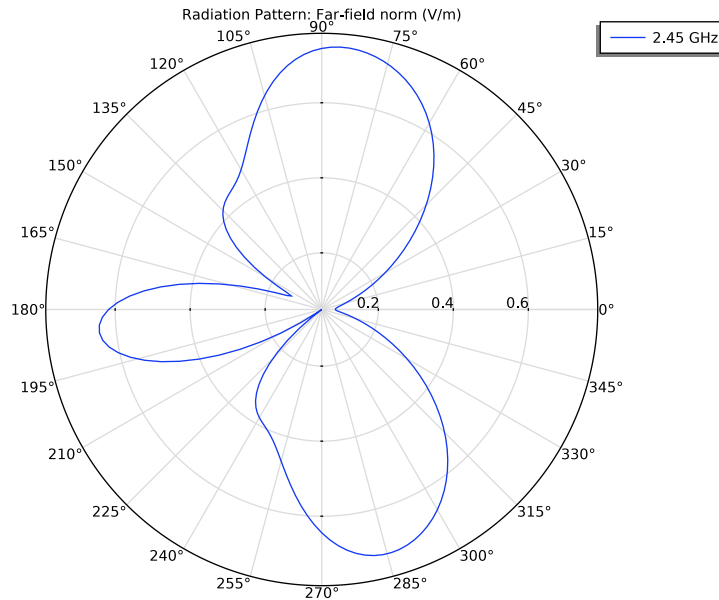

The default polar plot shows the far-field norm on the  $xy$ -plane.

### *Radiation Pattern 1*

- 1 In the **Model Builder** window, expand the **Results>3D Far Field, Gain (emw)** node, then click **Radiation Pattern 1**.
- 2 In the **Settings** window for **Radiation Pattern**, locate the **Evaluation** section.
- 3 Find the **Angles** subsection. In the **Number of elevation angles** text field, type 90.
- 4 In the **Number of azimuth angles** text field, type 90.
- 5 Locate the **Coloring and Style** section. From the **Color table** list, choose **Twilight**.

**6** From the **Color table transformation** list, choose **Reverse**.

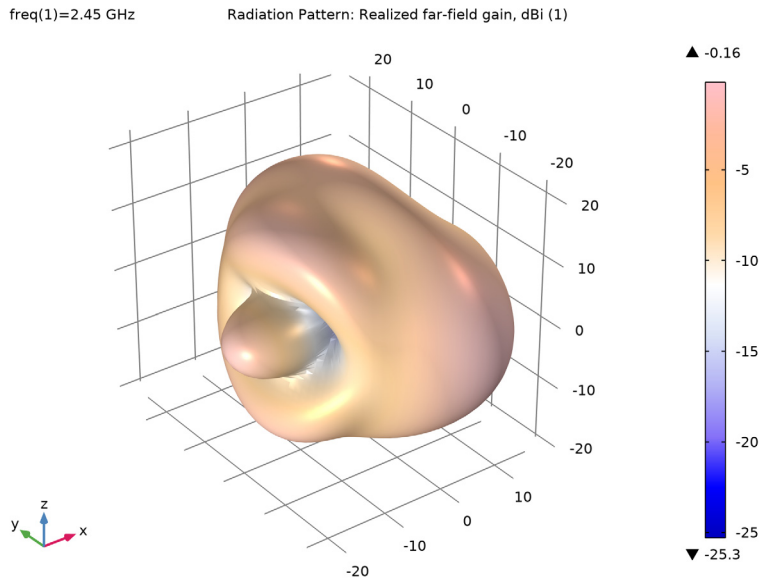



The far-field radiation pattern of the microstrip patch antenna is distorted due to the reflection from the human head.

*Filter 1*

- 1** In the **Model Builder** window, expand the **Results>Specific Absorption Rate (sar1)** node.
- 2** Right-click **Volume 1** and choose **Filter**.
- 3** In the **Settings** window for **Filter**, locate the **Element Selection** section.
- 4** In the **Logical expression for inclusion** text field, type  $z < 0.04 \ \&\& \ x > 0$ .

The computed SAR values are plotted over the entire SAR domain. By adding a filter subfeature, the values inside the domain can be visualized.

*Specific Absorption Rate (sar1)*

- 1** In the **Model Builder** window, under **Results** click **Specific Absorption Rate (sar1)**.
- 2** In the **Settings** window for **3D Plot Group**, click to expand the **Selection** section.
- 3** Locate the **Plot Settings** section. Clear the **Plot dataset edges** check box.
- 4** In the **Specific Absorption Rate (sar1)** toolbar, click  **Plot**.
- 5** Click the  **Zoom Extents** button in the **Graphics** toolbar.

Compared the SAR plot with [Figure 2](#).





