

Monopole Antenna Array

Introduction

It is possible to shape the radiation pattern and steer the beam from an antenna array by controlling the relative phases and magnitudes of the input signal. This example shows how to design an active electronically scanned array (AESA) using arithmetic phase progression on each antenna element.

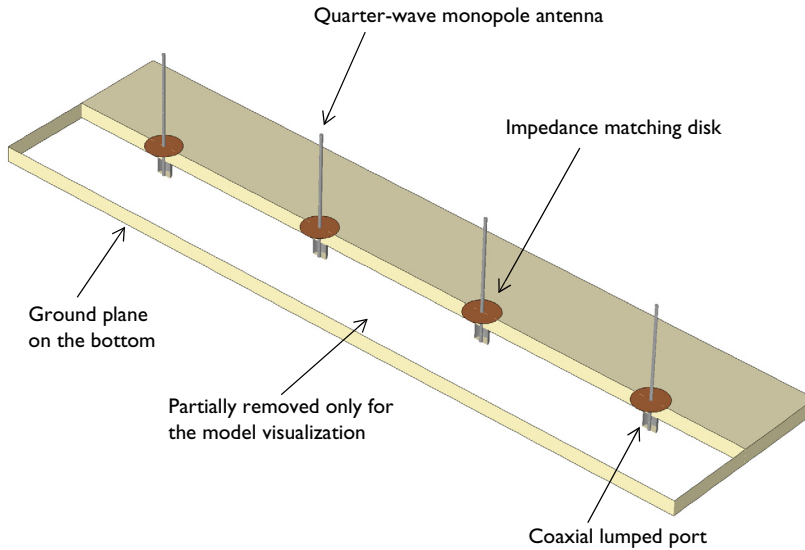

Figure 1: 4×1 monopole antenna array on a substrate.

Model Definition

This example (Figure 1) simulates four quarter-wave monopole antenna mounted on a dielectric substrate. Each antenna is fed by a coaxial lumped port and the outer conductor of each coaxial feed is connected to the ground plane on the bottom of the dielectric ($\epsilon_r = 3.38$) substrate. The space between the inner and outer conductor of the coaxial cable is filled with Teflon. The distance between the antenna elements is 0.47 wavelength in free space compromising a relatively high gain and low side lobes as well as preventing unwanted grating lobes. Metallic circles are patterned on the top of the substrate and connected to the each monopole radiator part. These circular patches compensate the inductance caused by the monopole design and provide a reasonable impedance matching to the reference impedance 50Ω . All metal parts are modeled as perfect electric conductor

(PEC). The antenna is modeled in a spherical air domain. The air domain is truncated with the Perfectly Matched Layers (PMLs) to absorb the radiated fields from the array structure.

All domains except the PMLs are meshed by a tetrahedral mesh with maximum element size of five elements per wavelength so that the wave is well-resolved. The monopole radiators and coaxial cables are meshed more finely to provide good resolution of the curved surfaces. The PMLs are swept with a total of five elements along the absorbing direction.

First, only the rightmost antenna element is excited while the rest of elements are terminated with 50Ω to show a relatively low gain radiation pattern and distortion from the coupling with passive elements. Then, all elements are excited with the same magnitude and arithmetic phase variation ($0, \alpha, 2\alpha, 3\alpha$) with the unit phase α as in [Table 1](#) to generate a higher gain and scannable radiation pattern.

TABLE 1: EXCITED PHASE VARIATION ON EACH ANTENNA ELEMENT IN DEGREE.

UNIT PHASE	LUMPED PORT1	LUMPED PORT2	LUMPED PORT3	LUMPED PORT4
-90	0	-90	-180	-270
-45	0	-45	-90	-135
0	0	0	0	0
45	0	45	90	135
90	0	90	180	270

Results and Discussion

The maximum range of the default electric field norm plot is adjusted to emphasize the near field around the monopole radiators in [Figure 2](#). Though only one antenna is excited, the electric fields coupled to other antenna elements are observed, too. The 3D far-field pattern in [Figure 3](#) is distorted compared to that of a typical monopole antenna due to the coupling and asymmetric ground plane configuration to the excited antenna.

When all antenna elements are excited at the same time ([Figure 4](#)), the radiation pattern is more directive. While the unit phase α is parametrically swept from -90 to 90 degrees, the direction of maximum radiation is changing gradually.

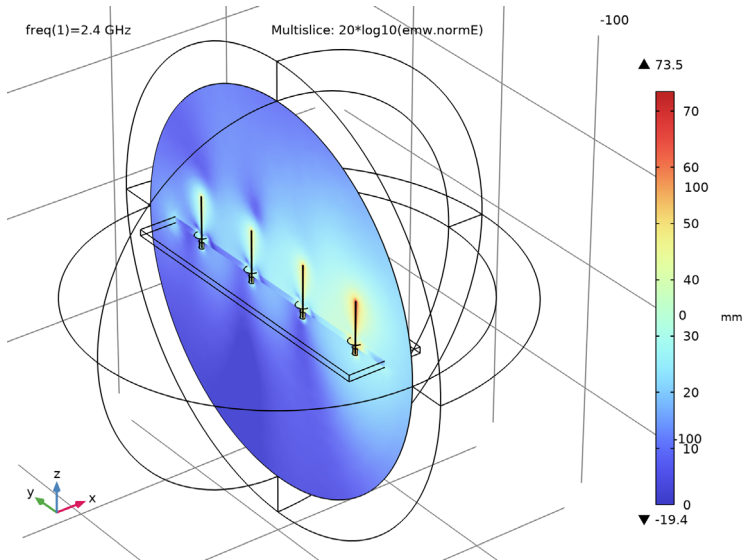

Figure 2: The strongest electric fields are observed around the excited monopole antenna. The plot also shows that the excited energy is coupled to other antennas elements.

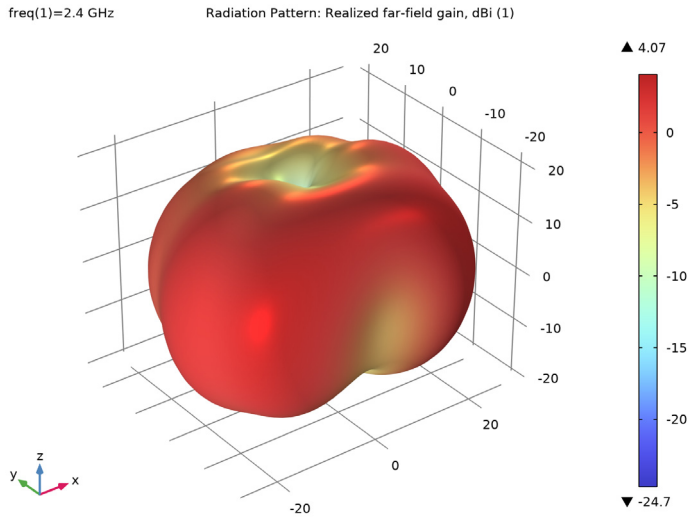

Figure 3: The distorted radiation pattern is generated due to the coupling to the passive antenna elements.

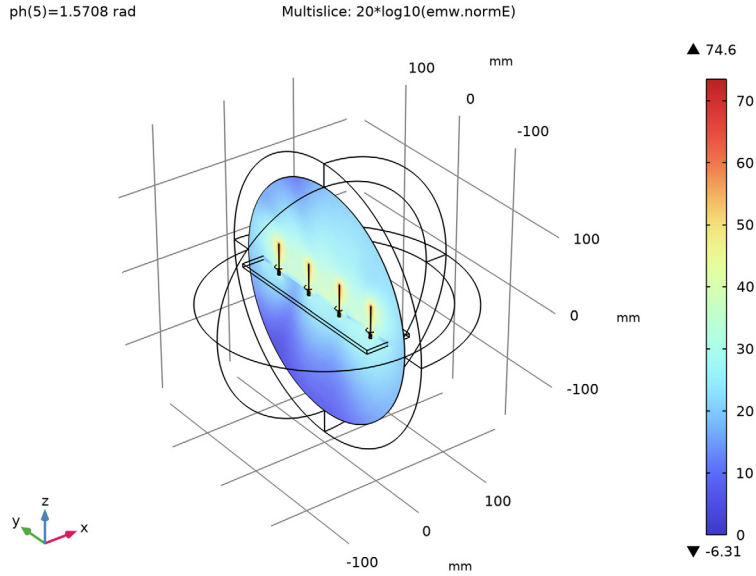

Figure 4: Each antenna element shows a strong field distribution around the monopole radiator.

The direction of maximum radiation is normal to the equiphase plane, so the radiation pattern is tilted to the direction of the faster antenna element in terms of phase. This is the basic idea of a phased array which can steer the beam toward a desired direction; See [Figure 5](#).

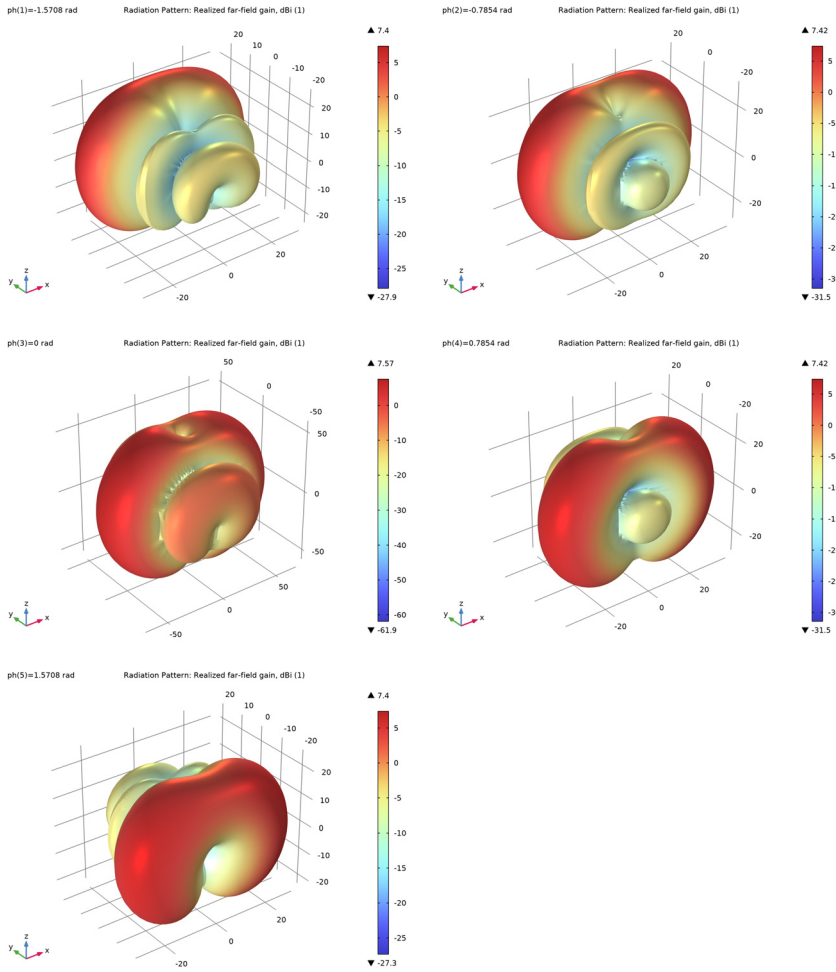



Figure 5: 3D far-field radiation pattern while the unit phase variation is changing from -90 to 90 degrees in 45 degree steps.

Application Library path: RF_Module/Antenna_Arrays/monopole_antenna_array



Modeling Instructions

From the **File** menu, choose **New**.

NEW

In the **New** window, click  **Model Wizard**.

MODEL WIZARD

- 1 In the **Model Wizard** window, click .
- 2 In the **Select Physics** tree, select **Radio Frequency>Electromagnetic Waves, Frequency Domain (emw)**.
- 3 Click **Add**.
- 4 Click  **Study**.
- 5 In the **Select Study** tree, select **General Studies>Frequency Domain**.
- 6 Click  **Done**.

STUDY I

Step 1: Frequency Domain

- 1 In the **Model Builder** window, under **Study I** click **Step 1: Frequency Domain**.
- 2 In the **Settings** window for **Frequency Domain**, locate the **Study Settings** section.
- 3 In the **Frequencies** text field, type 2.4[GHz].

GLOBAL DEFINITIONS

Parameters 1

- 1 In the **Model Builder** window, under **Global Definitions** click **Parameters 1**.
- 2 In the **Settings** window for **Parameters**, locate the **Parameters** section.
- 3 In the table, enter the following settings:

Name	Expression	Value	Description
spacing	$c_const/2.4[\text{GHz}] * 0.47$	0.058709 m	Array spacing
ph	60[deg]	1.0472 rad	Array phase progression

Here, c_const is a predefined COMSOL constant for the speed of light in vacuum.

GEOMETRY I



- 1 In the **Model Builder** window, under **Component 1 (comp1)** click **Geometry I**.
- 2 In the **Settings** window for **Geometry**, locate the **Units** section.
- 3 From the **Length unit** list, choose **mm**.

Sphere 1 (sph1)

- 1 In the **Geometry** toolbar, click  **Sphere**.
- 2 In the **Settings** window for **Sphere**, locate the **Size** section.
- 3 In the **Radius** text field, type 180.
- 4 Click to expand the **Layers** section. In the table, enter the following settings:

Layer name	Thickness (mm)
Layer 1	30

Block 1 (blk1)

- 1 In the **Geometry** toolbar, click  **Block**.
- 2 Click the  **Wireframe Rendering** button in the **Graphics** toolbar.
- 3 In the **Settings** window for **Block**, locate the **Size and Shape** section.
- 4 In the **Width** text field, type 60.
- 5 In the **Depth** text field, type 240.
- 6 In the **Height** text field, type 5.
- 7 Locate the **Position** section. In the **x** text field, type -30.
- 8 In the **y** text field, type -120.

Cylinder 1 (cyl1)



- 1 In the **Geometry** toolbar, click  **Cylinder**.
- 2 In the **Settings** window for **Cylinder**, locate the **Size and Shape** section.
- 3 In the **Radius** text field, type 0.5.
- 4 In the **Height** text field, type 41.
- 5 Locate the **Position** section. In the **y** text field, type -1.5*spacing.
- 6 In the **z** text field, type -5.

Cylinder 2 (cyl2)

- 1 In the **Geometry** toolbar, click  **Cylinder**.
- 2 In the **Settings** window for **Cylinder**, locate the **Size and Shape** section.
- 3 In the **Radius** text field, type 2.35.

- 4 In the **Height** text field, type 5.
- 5 Locate the **Position** section. In the **y** text field, type $-1.5*\text{spacing}$.
- 6 In the **z** text field, type -5.

Work Plane 1 (wp1)

- 1 In the **Geometry** toolbar, click  **Work Plane**.
- 2 In the **Settings** window for **Work Plane**, locate the **Plane Definition** section.
- 3 In the **z-coordinate** text field, type 5.
- 4 Click  **Show Work Plane**.

Work Plane 1 (wp1)>Circle 1 (c1)

- 1 In the **Work Plane** toolbar, click  **Circle**.
- 2 In the **Settings** window for **Circle**, locate the **Size and Shape** section.
- 3 In the **Radius** text field, type 5.5.
- 4 Locate the **Position** section. In the **yw** text field, type $-1.5*\text{spacing}$.

Array 1 (arr1)

- 1 In the **Model Builder** window, right-click **Geometry 1** and choose **Transforms>Array**.
- 2 Select the objects **cyl1**, **cyl2**, and **wp1** only.
- 3 In the **Settings** window for **Array**, locate the **Size** section.
- 4 In the **y size** text field, type 4.
- 5 Locate the **Displacement** section. In the **y** text field, type spacing .

6 Click  **Build All Objects**.

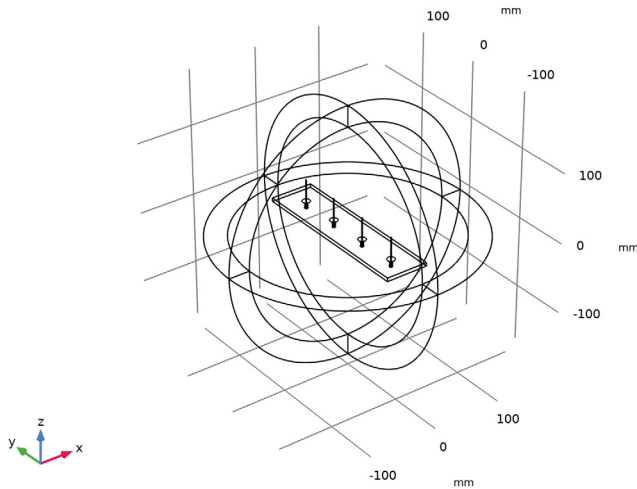

The finished geometry should look like this.

DEFINITIONS

Perfectly Matched Layer 1 (pml1)

- 1 In the **Definitions** toolbar, click  **Perfectly Matched Layer**.
- 2 Select Domains 1–4 and 23–26 only.
- 3 In the **Settings** window for **Perfectly Matched Layer**, locate the **Geometry** section.
- 4 From the **Type** list, choose **Spherical**.

ELECTROMAGNETIC WAVES, FREQUENCY DOMAIN (EMW)

- 1 In the **Model Builder** window, under **Component 1 (comp1)** click **Electromagnetic Waves, Frequency Domain (emw)**.
- 2 Select Domains 1–10 and 23–26 only.

These are all domains except the monopole radiators and center conductor of the coaxial feeds. By removing from the model domain, PEC conditions are applied by default on the boundaries of the removed domains.

Perfect Electric Conductor 2

- 1 In the **Physics** toolbar, click  **Boundaries** and choose **Perfect Electric Conductor**.

- 2 Select Boundaries 15, 18–23, 26, 27, 30, 31, 34, 35, 85, 92, 93, 100, 109, 116, 117, and 124 only.

You can do this most easily by copying the text '15, 18–23, 26, 27, 30, 31, 34, 35, 85, 92, 93, 100, 109, 116, 117, and 124', clicking in the selection box, and then pressing **Ctrl+V**, or by using the Paste Selection dialog box.

Lumped Port 1

- 1 In the **Physics** toolbar, click  **Boundaries** and choose **Lumped Port**.
- 2 Select Boundary 24 only.
- 3 In the **Settings** window for **Lumped Port**, locate the **Lumped Port Properties** section.
- 4 From the **Type of lumped port** list, choose **Coaxial**.
For the first port, wave excitation is **on** by default.

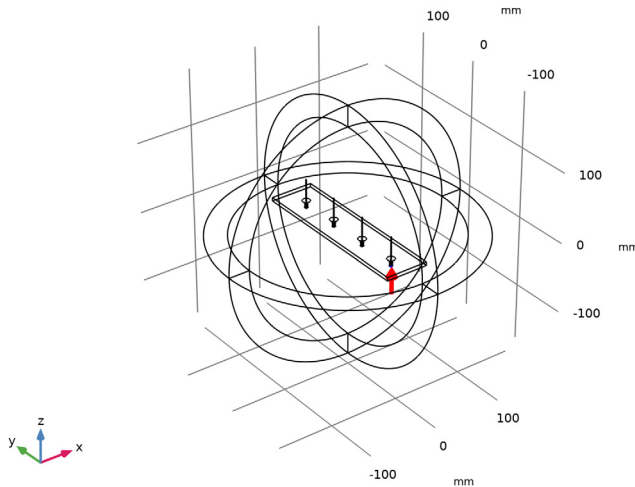



- 5 Click the  **Zoom Extents** button in the **Graphics** toolbar.

Far-Field Domain 1

In the **Physics** toolbar, click  **Domains** and choose **Far-Field Domain**.

ADD MATERIAL

- 1 In the **Home** toolbar, click  **Add Material** to open the **Add Material** window.
- 2 Go to the **Add Material** window.
- 3 In the tree, select **Built-in>Air**.

- 4 Click **Add to Component** in the window toolbar.
- 5 In the **Home** toolbar, click  **Add Material** to close the **Add Material** window.

MATERIALS

Material 2 (mat2)

- 1 In the **Model Builder** window, under **Component 1 (comp1)** right-click **Materials** and choose **Blank Material**.
- 2 Select Domain 6 only.
- 3 In the **Settings** window for **Material**, locate the **Material Contents** section.
- 4 In the table, enter the following settings:

Property	Variable	Value	Unit	Property group
Relative permittivity	epsilon _{r_} iso ; epsilon _{r_} ii = epsilon _{r_} iso, epsilon _{r_} ij = 0	3.38		Basic
Relative permeability	mu _{r_} iso ; mu _{r_} ii = mu _{r_} iso, mu _{r_} ij = 0	1		Basic
Electrical conductivity	sigma _{iso} ; sigma _{ii} = sigma _{iso} , sigma _{ij} = 0	0	S/m	Basic

Material 3 (mat3)

- 1 Right-click **Materials** and choose **Blank Material**.
- 2 Select Domains 7–10 only.
- 3 In the **Settings** window for **Material**, locate the **Material Contents** section.

4 In the table, enter the following settings:

Property	Variable	Value	Unit	Property group
Relative permittivity	epsilon _{r_} iso ; epsilon _{r_} ii = epsilon _{r_} iso, epsilon _{r_} ij = 0	2.1		Basic
Relative permeability	mu _{r_} iso ; mu _{r_} ii = mu _{r_} iso, mu _{r_} ij = 0	1		Basic
Electrical conductivity	sigma _{iso} ; sigma _{ii} = sigma _{iso} , sigma _{ij} = 0	0	S/m	Basic

MESH 1

In the **Model Builder** window, under **Component 1 (comp1)** right-click **Mesh 1** and choose **Build All**.

DEFINITIONS

Hide for Physics 1

- 1 In the **Model Builder** window, right-click **View 1** and choose **Hide for Physics**.
- 2 Select Domains 1–4 only.

Hide for Physics 2

- 1 Right-click **View 1** and choose **Hide for Physics**.
- 2 In the **Settings** window for **Hide for Physics**, locate the **Geometric Entity Selection** section.
- 3 From the **Geometric entity level** list, choose **Boundary**.
- 4 Select Boundaries 9–12 only.

MESH 1

Click the  **Zoom In** button in the **Graphics** toolbar.

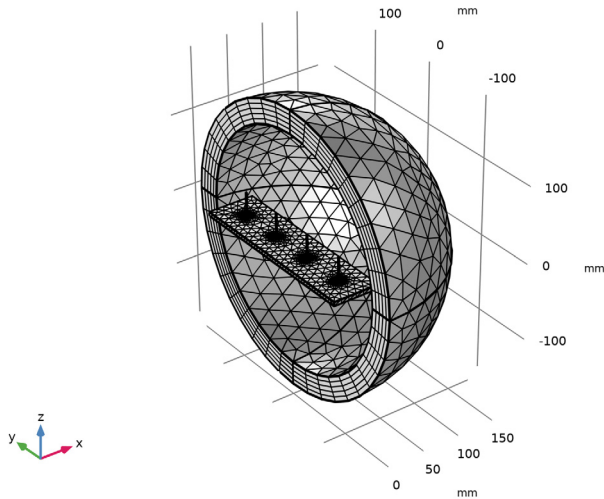

STUDY 1

In the **Home** toolbar, click  **Compute**.

RESULTS





S-parameter (emw)

S-parameter is calculated with a single port excitation. When the antenna is matched properly, the computed S-parameter value (S_{11}) should be better than -10dB.

1 In the **Model Builder** window, expand the **Results>Derived Values** node.

Multislice

- 1 In the **Model Builder** window, expand the **Results>Electric Field (emw)** node, then click **Multislice**.
- 2 In the **Settings** window for **Multislice**, locate the **Expression** section.
- 3 In the **Expression** text field, type $20 * \log_{10}(emw.normE)$.
- 4 Locate the **Multipane Data** section. Find the **Y-planes** subsection. In the **Planes** text field, type 0.
- 5 Find the **Z-planes** subsection. In the **Planes** text field, type 0.
- 6 Find the **X-planes** subsection. From the **Entry method** list, choose **Coordinates**.

- 7 In the **Coordinates** text field, type 0.
 - 8 In the **Electric Field (emw)** toolbar, click  **Plot**.
 - 9 Click to expand the **Range** section. Select the **Manual color range** check box.
 - 10 In the **Minimum** text field, type 0.
 - 11 In the **Electric Field (emw)** toolbar, click  **Plot**.
 - 12 Click the  **Zoom Extents** button in the **Graphics** toolbar.
 - 13 Click the  **Zoom In** button in the **Graphics** toolbar.
- Compare the reproduced plot with [Figure 2](#).

Radiation Pattern 1

- 1 In the **Model Builder** window, expand the **3D Far Field, Gain (emw)** node, then click **Radiation Pattern 1**.
- 2 In the **Settings** window for **Radiation Pattern**, locate the **Evaluation** section.
- 3 Find the **Angles** subsection. In the **Number of elevation angles** text field, type 90.
- 4 In the **Number of azimuth angles** text field, type 90.
- 5 In the **3D Far Field, Gain (emw)** toolbar, click  **Plot**.



TABLE

- 1 Go to the **Table** window.
- This reproduces [Figure 3](#).

Excite all ports with arithmetic phase variation using the parameter ph defined previously.

ELECTROMAGNETIC WAVES, FREQUENCY DOMAIN (EMW)

Lumped Port 2

- 1 In the **Physics** toolbar, click  **Boundaries** and choose **Lumped Port**.
- 2 Click the  **Zoom Extents** button in the **Graphics** toolbar.
- 3 Select Boundary 28 only.
- 4 In the **Settings** window for **Lumped Port**, locate the **Lumped Port Properties** section.
- 5 From the **Type of lumped port** list, choose **Coaxial**.
- 6 From the **Wave excitation at this port** list, choose **On**.
- 7 In the θ_{in} text field, type ph .

Lumped Port 3

- 1 In the **Physics** toolbar, click  **Boundaries** and choose **Lumped Port**.



- 2 Select Boundary 32 only.
- 3 In the **Settings** window for **Lumped Port**, locate the **Lumped Port Properties** section.
- 4 From the **Type of lumped port** list, choose **Coaxial**.
- 5 From the **Wave excitation at this port** list, choose **On**.
- 6 In the θ_{in} text field, type $ph*2$.

Lumped Port 4

- 1 In the **Physics** toolbar, click  **Boundaries** and choose **Lumped Port**.
- 2 Select Boundary 36 only.
- 3 In the **Settings** window for **Lumped Port**, locate the **Lumped Port Properties** section.
- 4 From the **Type of lumped port** list, choose **Coaxial**.
- 5 From the **Wave excitation at this port** list, choose **On**.
- 6 In the θ_{in} text field, type $ph*3$.

STUDY 1

Parametric Sweep

- 1 In the **Study** toolbar, click  **Parametric Sweep**.
- 2 In the **Settings** window for **Parametric Sweep**, locate the **Study Settings** section.
- 3 Click  **Add**.
- 4 From the list in the **Parameter name** column, choose **ph (Array phase progression)**.
- 5 Click  **Range**.
- 6 In the **Range** dialog box, type $-90[\text{deg}]$ in the **Start** text field.
- 7 In the **Step** text field, type $45[\text{deg}]$.
- 8 In the **Stop** text field, type $90[\text{deg}]$.
- 9 Click **Add**.

RESULTS

S-parameter (emw)

In the **Model Builder** window, under **Results>Derived Values** right-click **S-parameter (emw)** and choose **Disable**, as for multiple port excitation the S-parameter is not defined.

STUDY 1

In the **Study** toolbar, click  **Compute**.



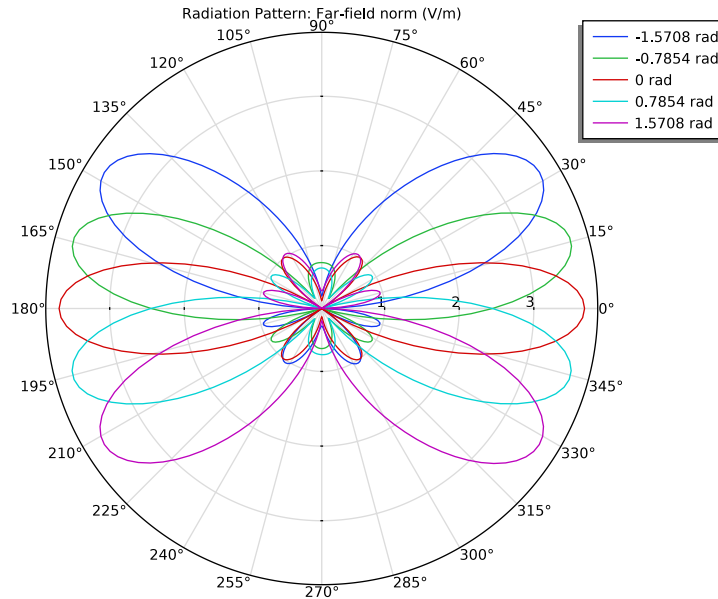

RESULTS

Radiation Pattern I

- 1 In the **Model Builder** window, expand the **Results>2D Far Field (emw)** node, then click **Radiation Pattern I**.
- 2 In the **2D Far Field (emw)** toolbar, click  **Plot**.



3D Far Field, Gain (emw)

- 1 Click the  **Zoom Extents** button in the **Graphics** toolbar.
- 2 In the **Model Builder** window, under **Results** click **3D Far Field, Gain (emw)**.
- 3 In the **Settings** window for **3D Plot Group**, locate the **Data** section.
- 4 From the **Parameter value (ph (rad))** list, choose **-0.7854**.
- 5 In the **3D Far Field, Gain (emw)** toolbar, click  **Plot**.
- 6 From the **Parameter value (ph (rad))** list, choose **0**.
- 7 In the **3D Far Field, Gain (emw)** toolbar, click  **Plot**.
- 8 From the **Parameter value (ph (rad))** list, choose **0.7854**.
- 9 In the **3D Far Field, Gain (emw)** toolbar, click  **Plot**.
- 10 From the **Parameter value (ph (rad))** list, choose **1.5708**.

II In the **3D Far Field, Gain (emw)** toolbar, click  **Plot**.

Compare the plotted each 3D radiation pattern with [Figure 5](#).