



Double-Ridged Horn Antenna

Introduction

A double-ridged horn antenna is popularly used in an anechoic chamber to characterize an antenna under test (AUT) from S-band to Ku-band due to its reliable performance in a wideband frequency range. The model computes the voltage standing wave ratio (VSWR), far-field radiation pattern, and antenna directivity.

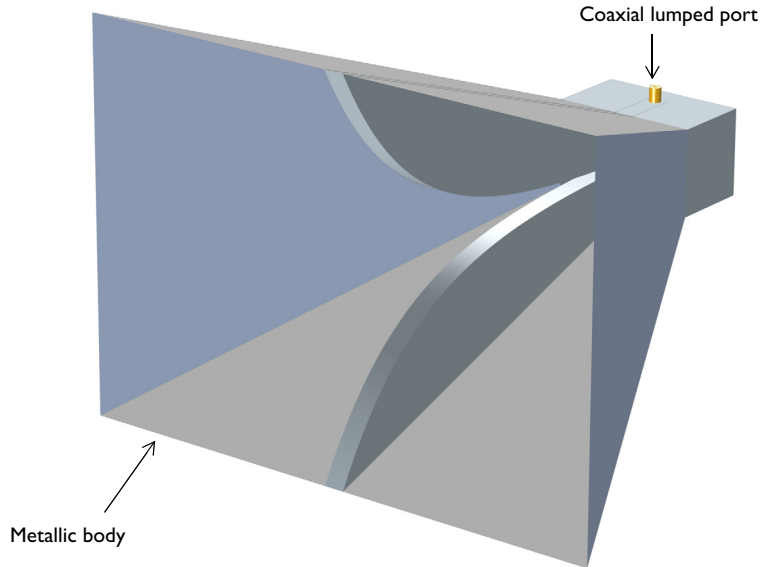

Figure 1: Double-ridged horn antenna excited by a coaxial port. The surrounding air domain and a perfectly matched layer, which is required for the simulation, are not included in this figure.

Note: This example requires the RF Module and the Design Module.

Model Definition

The simulation frequency range is from 2 GHz to 6 GHz. The conductivity of the metallic material in the model is assumed to be high enough to neglect the loss in the given frequency range. Thus, all metal parts are modeled using a perfect electric conductor (PEC) feature. An exponential function, $e^{0.028x}$ is used in a parametric curve to create the tapered metallic ridges that are excited by an SMA type dielectric-filled coaxial connector.

A lumped port is assigned on the boundary between the inner and outer conducting surface at the end of the coaxial connector. The antenna is enclosed by a spherical air domain. The outermost layer of the air domain is configured as a perfectly matched layer (PML) where the thickness of the layer is slightly greater than 0.1 wavelengths at the lowest simulation frequency. The PML absorbs all outgoing radiation from the antenna and work as an anechoic chamber during the simulation. The mesh is controlled by the Electromagnetic Waves, Frequency Domain physics interface and it has to be defined dynamically based on each simulation frequency, so frequency parametric sweep is over Frequency Domain study step.

Results and Discussion

In [Figure 2](#), the slice and contour plot of E_z is visualized in the zx -plane. The electric field is guided by two symmetric metallic ridges and propagating toward the aperture of the horn.

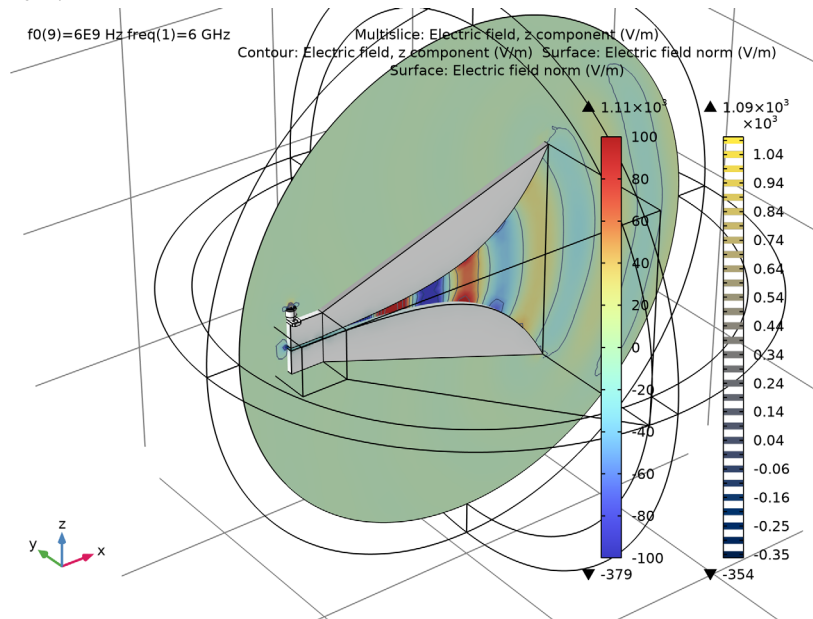

Figure 2: z-component of the electric field and its contour plot at 6 GHz.

[Figure 3](#) shows the 3D far-field radiation pattern. When it is plotted, the directivity is also calculated which is around 12.9 dB. Other antenna far-field postprocessing variables such as antenna gain and axial ratio can be visualized using the same plot by replacing the

default input fields both for expression and color. These steps are not included in this tutorial but you are encouraged to try.

f0(9)=6E9 Hz freq(1)=6 GHz Radiation Pattern: Realized far-field gain, dBi (1)

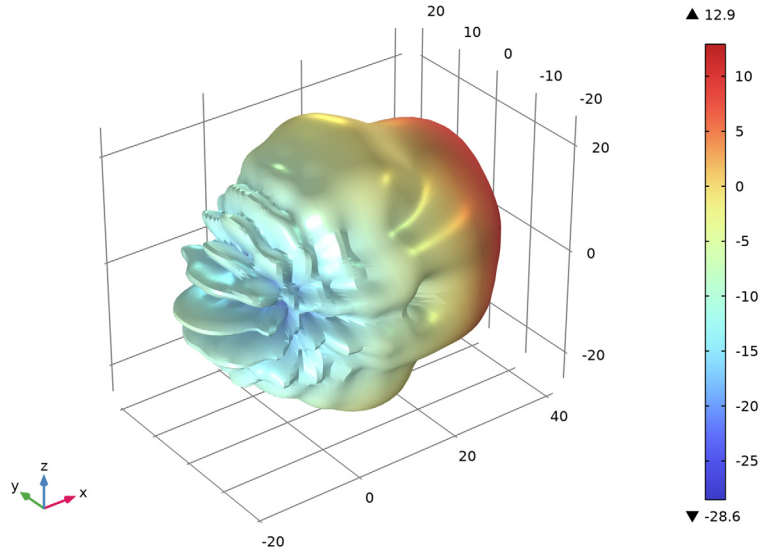

Figure 3: 3D far-field radiation pattern that is directive toward the open aperture.

Voltage standing wave ratio (VSWR) is a measure commonly used to characterize the input impedance matching properties for off-the-shelf antenna products. [Figure 4](#) presents the VSWR of the double-ridged horn antenna that is lower than 1.7 in the simulated frequency range.

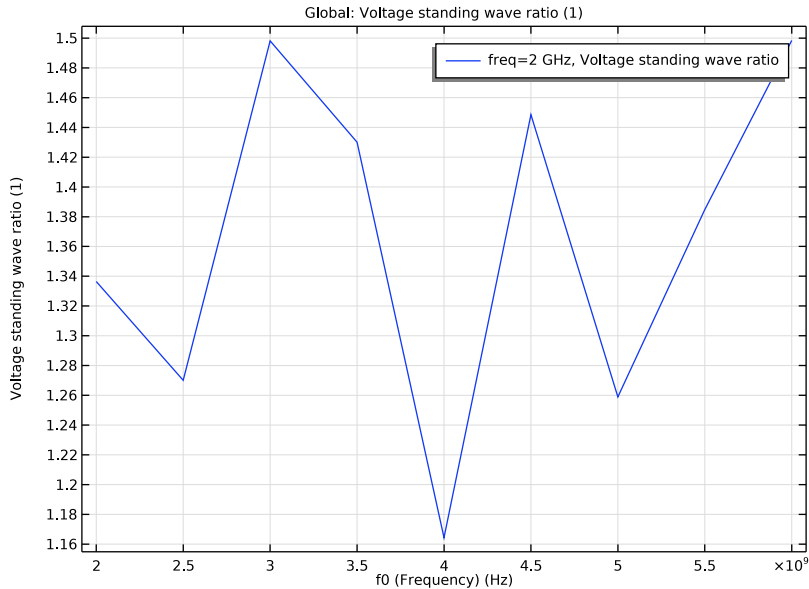

Figure 4: Voltage standing wave ratio (VSWR) plot. It is better than 2:1 in the simulated frequency range

Notes About the COMSOL Implementation

The antenna model is memory intensive and requires more than 12 GB RAM for the simulation up to 6 GHz. It may require much more for higher frequency simulations.

Application Library path: RF_Module/Antennas/double_ridged_horn_antenna



Modeling Instructions

From the **File** menu, choose **New**.

NEW

In the **New** window, click  **Model Wizard**.

MODEL WIZARD

- 1 In the **Model Wizard** window, click  **3D**.
- 2 In the **Select Physics** tree, select **Radio Frequency>Electromagnetic Waves, Frequency Domain (emw)**.
- 3 Click **Add**.
- 4 Click  **Study**.
- 5 In the **Select Study** tree, select **General Studies>Frequency Domain**.
- 6 Click  **Done**.

GLOBAL DEFINITIONS

Parameters 1

- 1 In the **Model Builder** window, under **Global Definitions** click **Parameters 1**.
- 2 In the **Settings** window for **Parameters**, locate the **Parameters** section.
- 3 In the table, enter the following settings:

Name	Expression	Value	Description
w_slot	1.8[mm]	0.0018 m	Slot width
f0	2[GHz]	2E9 Hz	Frequency

STUDY 1

Step 1: Frequency Domain

- 1 In the **Model Builder** window, under **Study 1** click **Step 1: Frequency Domain**.
- 2 In the **Settings** window for **Frequency Domain**, locate the **Study Settings** section.
- 3 In the **Frequencies** text field, type f0.

GEOMETRY 1

- 1 In the **Model Builder** window, under **Component 1 (comp1)** click **Geometry 1**.
- 2 In the **Settings** window for **Geometry**, locate the **Units** section.
- 3 From the **Length unit** list, choose **mm**.
- 4 Locate the **Advanced** section. From the **Geometry representation** list, choose **CAD kernel**.

Work Plane 1 (wp1)

- 1 In the **Geometry** toolbar, click  **Work Plane**.
- 2 In the **Settings** window for **Work Plane**, locate the **Plane Definition** section.
- 3 From the **Plane** list, choose **xz-plane**.

4 In the **y-coordinate** text field, type 3.5.

Work Plane 1 (wp1)>Plane Geometry

In the **Model Builder** window, click **Plane Geometry**.

Work Plane 1 (wp1)>Parametric Curve 1 (pcl)

1 In the **Work Plane** toolbar, click  **More Primitives** and choose **Parametric Curve**.

2 In the **Settings** window for **Parametric Curve**, locate the **Parameter** section.

3 In the **Maximum** text field, type 150.

4 Locate the **Expressions** section. In the **xw** text field, type $s - 100$.

5 In the **yw** text field, type $\exp(0.028*s) - 1 + w_slot/2$.

Work Plane 1 (wp1)>Mirror 1 (mir1)

1 In the **Work Plane** toolbar, click  **Transforms** and choose **Mirror**.

2 Select the object **pcl** only.

3 In the **Settings** window for **Mirror**, locate the **Input** section.

4 Select the **Keep input objects** check box.

5 Locate the **Normal Vector to Line of Reflection** section. In the **xw** text field, type 0.

6 In the **yw** text field, type 1.

Work Plane 1 (wp1)>Rectangle 1 (r1)

1 In the **Work Plane** toolbar, click  **Rectangle**.

2 In the **Settings** window for **Rectangle**, locate the **Size and Shape** section.

3 In the **Width** text field, type 20.15.

4 In the **Height** text field, type w_slot .

5 Locate the **Position** section. In the **xw** text field, type -120.15 .

6 In the **yw** text field, type $-w_slot/2$.

7 Click  **Build Selected**.

8 Click the  **Zoom Extents** button in the **Graphics** toolbar.

Work Plane 1 (wp1)>Rectangle 2 (r2)

1 In the **Work Plane** toolbar, click  **Rectangle**.

2 In the **Settings** window for **Rectangle**, locate the **Size and Shape** section.

3 In the **Width** text field, type 20.15.

4 In the **Height** text field, type 30.

5 Locate the **Position** section. In the **xw** text field, type -120.15 .

6 In the **yw** text field, type -15.

Work Plane 1 (wp1)>Polygon 1 (pol1)

- 1 In the **Work Plane** toolbar, click  **Polygon**.
- 2 In the **Settings** window for **Polygon**, locate the **Coordinates** section.
- 3 From the **Data source** list, choose **Vectors**.
- 4 In the **xw** text field, type 50 -100 -100 -100 -100 50.
- 5 In the **yw** text field, type $\exp(0.028*150) - 1 + w_slot/2$ 15 15 -15 -15 -
($\exp(0.028*150) - 1 + w_slot/2$).

Extrude 1 (ext1)

- 1 In the **Model Builder** window, right-click **Geometry 1** and choose **Extrude**.
- 2 In the **Settings** window for **Extrude**, locate the **Distances** section.
- 3 In the table, enter the following settings:

Distances (mm)
7

Work Plane 2 (wp2)

- 1 In the **Geometry** toolbar, click  **Work Plane**.
- 2 In the **Settings** window for **Work Plane**, locate the **Plane Definition** section.
- 3 From the **Plane** list, choose **yz-plane**.
- 4 In the **x-coordinate** text field, type 50.

Work Plane 2 (wp2)>Plane Geometry

In the **Model Builder** window, click **Plane Geometry**.

Work Plane 2 (wp2)>Rectangle 1 (r1)

- 1 In the **Work Plane** toolbar, click  **Rectangle**.
- 2 In the **Settings** window for **Rectangle**, locate the **Size and Shape** section.
- 3 In the **Width** text field, type 190.
- 4 In the **Height** text field, type $(\exp(0.028*150) - 1 + w_slot/2) * 2$.
- 5 Locate the **Position** section. In the **xw** text field, type -95.
- 6 In the **yw** text field, type $-(\exp(0.028*150) - 1 + w_slot/2)$.

Work Plane 3 (wp3)

- 1 In the **Model Builder** window, right-click **Geometry 1** and choose **Work Plane**.
- 2 In the **Settings** window for **Work Plane**, locate the **Plane Definition** section.

- 3 From the **Plane** list, choose **yz-plane**.
- 4 In the **x-coordinate** text field, type -100.

Work Plane 3 (wp3)>Plane Geometry

In the **Model Builder** window, click **Plane Geometry**.

Work Plane 3 (wp3)>Rectangle 1 (r1)

- 1 In the **Work Plane** toolbar, click  **Rectangle**.
- 2 In the **Settings** window for **Rectangle**, locate the **Size and Shape** section.
- 3 In the **Width** text field, type 50.
- 4 In the **Height** text field, type 30.
- 5 Locate the **Position** section. In the **xw** text field, type -25.
- 6 In the **yw** text field, type -15.



Extrude 2 (ext2)

- 1 In the **Model Builder** window, right-click **Geometry 1** and choose **Extrude**.
- 2 In the **Settings** window for **Extrude**, locate the **General** section.
- 3 From the **Input object handling** list, choose **Keep**.
- 4 Locate the **Distances** section. In the table, enter the following settings:

Distances (mm)
28

- 5 Select the **Reverse direction** check box.

Loft 1 (loft1)

- 1 In the **Geometry** toolbar, click  **Loft**.
- 2 Click the  **Wireframe Rendering** button in the **Graphics** toolbar.
- 3 Click the  **Zoom Extents** button in the **Graphics** toolbar.

4 Select the objects **wp2** and **wp3** only.

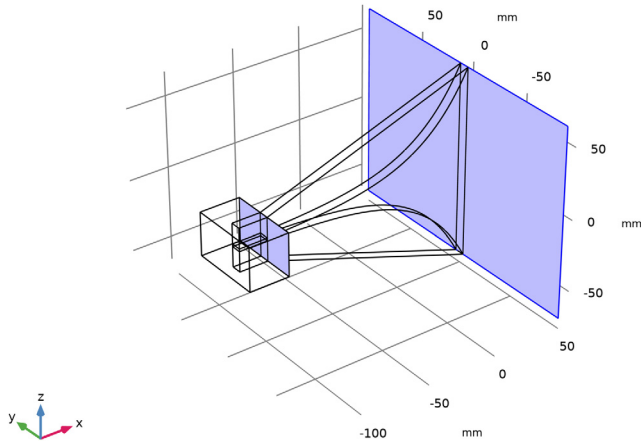

Cylinder 1 (cyl1)

- 1 In the **Geometry** toolbar, click  **Cylinder**.
- 2 In the **Settings** window for **Cylinder**, locate the **Size and Shape** section.
- 3 In the **Radius** text field, type 2.05 .
- 4 In the **Height** text field, type $15-w_slot/2$.
- 5 Locate the **Position** section. In the **x** text field, type -117.5 .
- 6 In the **z** text field, type $w_slot/2$.

Cylinder 2 (cyl2)

- 1 Right-click **Cylinder 1 (cyl1)** and choose **Duplicate**.
- 2 In the **Settings** window for **Cylinder**, locate the **Size and Shape** section.
- 3 In the **Radius** text field, type 0.635 .
- 4 In the **Height** text field, type $15+w_slot/2$.
- 5 Locate the **Position** section. In the **z** text field, type $-w_slot/2$.

PART LIBRARIES

- 1 In the **Geometry** toolbar, click  **Parts** and choose **Part Libraries**.
- 2 In the **Model Builder** window, click **Geometry 1**.

3 In the **Part Libraries** window, select **RF Module>Connectors>connector_sma_flange2** in the tree.

4 Click  **Add to Geometry**.

GEOMETRY I

SMA Connector, Flange with Two Holes I (pi1)

1 In the **Model Builder** window, under **Component 1 (comp1)>Geometry 1** click **SMA Connector, Flange with Two Holes I (pi1)**.

2 In the **Settings** window for **Part Instance**, locate the **Input Parameters** section.

3 In the table, enter the following settings:

Name	Expression	Value	Description
solder_o	0	0	Soldering block option

4 Locate the **Position and Orientation of Output** section. Find the **Displacement** subsection. In the **xw** text field, type -117.5.

5 In the **zw** text field, type 15.

6 Find the **Rotation** subsection. From the **Axis type** list, choose **yw-axis**.

7 In the **Rotation angle** text field, type 90.

8 Click to expand the **Boundary Selections** section. In the table, enter the following settings:

Name	Keep	Physics	Contribute to
Exterior		√	None
Conductive surface	√	√	None

9 Click to expand the **Domain Selections** section. In the table, enter the following settings:

Name	Keep	Physics	Contribute to
All		√	None
Dielectric	√	√	None
Conductor		√	None

10 Click  **Build Selected.**

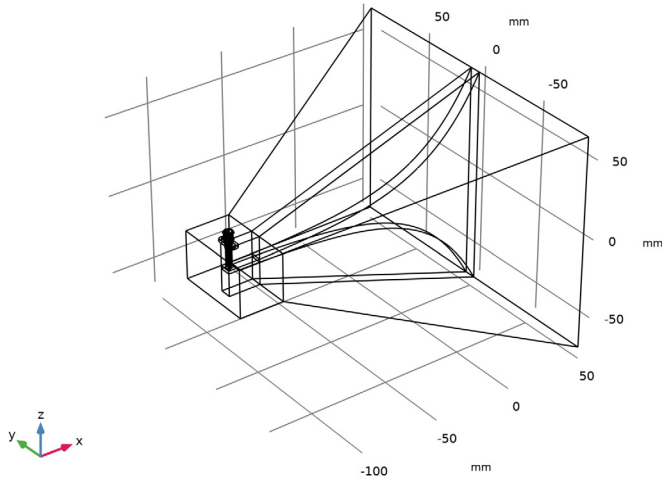

Sphere 1 (sph1)

- 1 In the **Geometry** toolbar, click  **Sphere**.
- 2 In the **Settings** window for **Sphere**, locate the **Size** section.
- 3 In the **Radius** text field, type 170.
- 4 Click to expand the **Layers** section. In the table, enter the following settings:

Layer name	Thickness (mm)
Layer 1	20

5 In the **Geometry** toolbar, click  **Build All**.

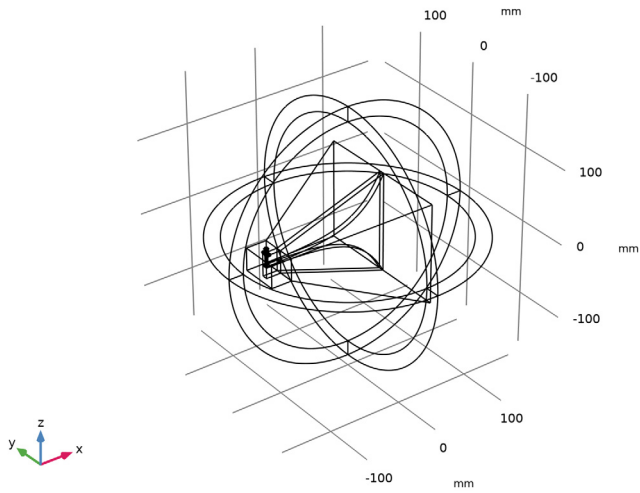

DEFINITIONS

Perfectly Matched Layer 1 (pml1)

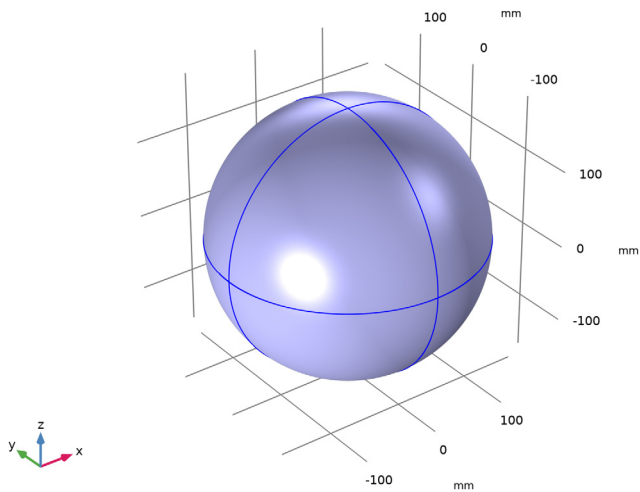

1 In the **Definitions** toolbar, click  **Perfectly Matched Layer**.

2 Select Domains 1–4 and 24–27 only.



- 3 In the **Settings** window for **Perfectly Matched Layer**, locate the **Geometry** section.
- 4 From the **Type** list, choose **Spherical**.

ADD MATERIAL

- 1 In the **Home** toolbar, click  **Add Material** to open the **Add Material** window.
- 2 Go to the **Add Material** window.
- 3 In the tree, select **Built-in>Air**.
- 4 Right-click and choose **Add to Component 1 (comp1)**.
- 5 In the **Home** toolbar, click  **Add Material** to close the **Add Material** window.

MATERIALS

Material 2 (mat2)

- 1 In the **Model Builder** window, under **Component 1 (comp1)** right-click **Materials** and choose **Blank Material**.
- 2 Select Domain 12 only.

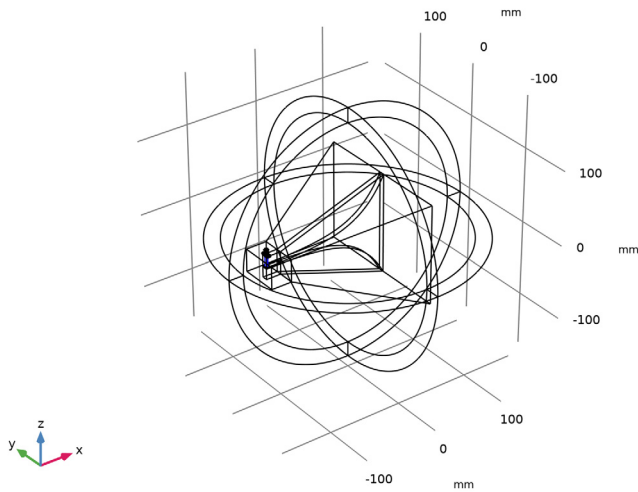

- 3 In the **Settings** window for **Material**, locate the **Material Contents** section.

4 In the table, enter the following settings:

Property	Variable	Value	Unit	Property group
Relative permittivity	epsilon _{nr_iso} ; epsilon _{nrii} = epsilon _{nr_iso} , epsilon _{nrij} = 0	2.1		Basic
Relative permeability	mu _{r_iso} ; mu _{rii} = mu _{r_iso} , mu _{rij} = 0	1		Basic
Electrical conductivity	sigma _{iso} ; sigma _{ii} = sigma _{iso} , sigma _{ij} = 0	0	S/m	Basic

Material 3 (mat3)

- 1 Right-click **Material 2 (mat2)** and choose **Duplicate**.
- 2 In the **Settings** window for **Material**, locate the **Geometric Entity Selection** section.
- 3 From the **Selection** list, choose **Dielectric (SMA Connector, Flange with Two Holes I)**.

ELECTROMAGNETIC WAVES, FREQUENCY DOMAIN (EMW)

Perfect Electric Conductor 2

- 1 In the **Model Builder** window, under **Component 1 (comp1)** right-click **Electromagnetic Waves, Frequency Domain (emw)** and choose **Perfect Electric Conductor**.
- 2 In the **Settings** window for **Perfect Electric Conductor**, locate the **Boundary Selection** section.
- 3 Click  **Paste Selection**.
- 4 In the **Paste Selection** dialog box, type 13-17, 28-30, 33-36, 45, 47, 50, 51, 53, 54, 66, 69-73, 75-79, 81, 82, 94, 95, 98-101, 103-106, 108, 109, 122, 124-126, 128, 129, 132, 134-136, 138, 139, 141-143 in the **Selection** text field.

5 Click **OK**.

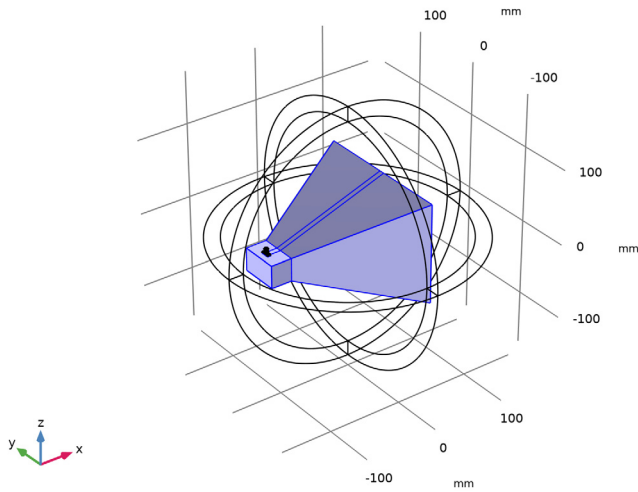

Perfect Electric Conductor 3

- 1 In the **Physics** toolbar, click  **Boundaries** and choose **Perfect Electric Conductor**.
- 2 In the **Settings** window for **Perfect Electric Conductor**, locate the **Boundary Selection** section.
- 3 From the **Selection** list, choose **Conductive surface (SMA Connector, Flange with Two Holes 1)**.

Lumped Port 1

- 1 In the **Physics** toolbar, click  **Boundaries** and choose **Lumped Port**.
- 2 Select Boundary 61 only.
- 3 In the **Settings** window for **Lumped Port**, locate the **Lumped Port Properties** section.
- 4 From the **Type of lumped port** list, choose **Coaxial**.
For the first port, wave excitation is **on** by default.

Far-Field Domain 1

In the **Physics** toolbar, click  **Domains** and choose **Far-Field Domain**.

DEFINITIONS

Hide for Physics 1

- 1 In the **Model Builder** window, right-click **View 1** and choose **Hide for Physics**.

- 2 In the **Settings** window for **Hide for Physics**, locate the **Geometric Entity Selection** section.
- 3 From the **Geometric entity level** list, choose **Boundary**.
- 4 Select Boundaries 3, 6, 8, 10, and 12 only.

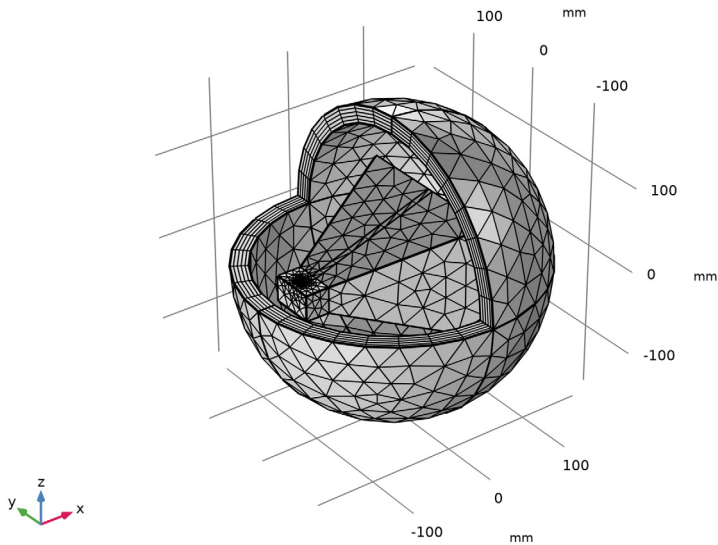

MESH 1

- 1 In the **Model Builder** window, under **Component 1 (comp1)** click **Mesh 1**.
- 2 In the **Settings** window for **Mesh**, locate the **Physics-Controlled Mesh** section.
- 3 From the **Element size** list, choose **Coarser**.
Use **Coarser** mesh to avoid unnecessarily fine mesh on small parts.
- 4 Click  **Build All**.



STUDY 1

Parametric Sweep

- 1 In the **Study** toolbar, click  **Parametric Sweep**.
- 2 In the **Settings** window for **Parametric Sweep**, locate the **Study Settings** section.
- 3 Click  **Add**.

4 In the table, enter the following settings:

Parameter name	Parameter value list	Parameter unit
f0 (Frequency)	range(2[GHz], 0.5[GHz], 6[GHz])	Hz

Step 1: Frequency Domain

In the **Study** toolbar, click  **Compute**.

RESULTS

Multislice

- 1 In the **Model Builder** window, expand the **Electric Field (emw)** node, then click **Multislice**.
- 2 In the **Settings** window for **Multislice**, locate the **Expression** section.
- 3 In the **Expression** text field, type `emw.Ez`.
- 4 Locate the **Multiplane Data** section. Find the **X-planes** subsection. In the **Planes** text field, type 0.
- 5 Find the **Z-planes** subsection. In the **Planes** text field, type 0.
- 6 Click to expand the **Range** section. Select the **Manual color range** check box.
- 7 In the **Minimum** text field, type -100.
- 8 In the **Maximum** text field, type 100.

Selection 1

- 1 Right-click **Multislice** and choose **Selection**.
- 2 Select Domains 5, 6, 10, and 21 only.
- 3 In the **Electric Field (emw)** toolbar, click  **Plot**.

Cut Plane 1

- 1 In the **Results** toolbar, click  **Cut Plane**.
- 2 In the **Settings** window for **Cut Plane**, locate the **Data** section.
- 3 From the **Dataset** list, choose **Study 1/Parametric Solutions 1 (sol2)**.
- 4 Locate the **Plane Data** section. From the **Plane** list, choose **XZ-planes**.

Contour 1

- 1 In the **Model Builder** window, right-click **Electric Field (emw)** and choose **Contour**.
- 2 In the **Settings** window for **Contour**, locate the **Data** section.
- 3 From the **Dataset** list, choose **Cut Plane 1**.
- 4 Locate the **Expression** section. In the **Expression** text field, type `emw.Ez`.

- 5 Locate the **Levels** section. In the **Total levels** text field, type 30.
- 6 Locate the **Coloring and Style** section. From the **Color table** list, choose **Cividis**.

Surface 1

- 1 Right-click **Electric Field (emw)** and choose **Surface**.
- 2 In the **Settings** window for **Surface**, locate the **Coloring and Style** section.
- 3 Clear the **Color legend** check box.
- 4 From the **Color table** list, choose **AuroraAustralis**.

Selection 1

- 1 Right-click **Surface 1** and choose **Selection**.
- 2 In the **Settings** window for **Selection**, locate the **Selection** section.
- 3 From the **Selection** list, choose **Conductive surface (SMA Connector, Flange with Two Holes 1)**.

Surface 2

- 1 In the **Model Builder** window, right-click **Electric Field (emw)** and choose **Surface**.
- 2 In the **Settings** window for **Surface**, locate the **Coloring and Style** section.
- 3 From the **Color table** list, choose **AuroraAustralis**.
- 4 Clear the **Color legend** check box.

Selection 1

- 1 Right-click **Surface 2** and choose **Selection**.
- 2 Select Boundaries 28–30, 33–36, 45, 47, 122, 128, 129, 132, 134–136, 138, and 141 only.
- 3 In the **Electric Field (emw)** toolbar, click  **Plot**.
Compare the reproduced plot with that shown in [Figure 2](#).

Radiation Pattern 1

- 1 In the **Model Builder** window, expand the **2D Far Field (emw)** node, then click **Radiation Pattern 1**.
- 2 In the **Settings** window for **Radiation Pattern**, click to expand the **Legends** section.
- 3 From the **Legends** list, choose **Manual**.

4 In the table, enter the following settings:

Legends

2GHz

2.5GHz

3GHz

3.5GHz

4GHz

4.5GHz

5GHz

5.5GHz

6GHz

5 In the **2D Far Field (emw)** toolbar, click  **Plot**.

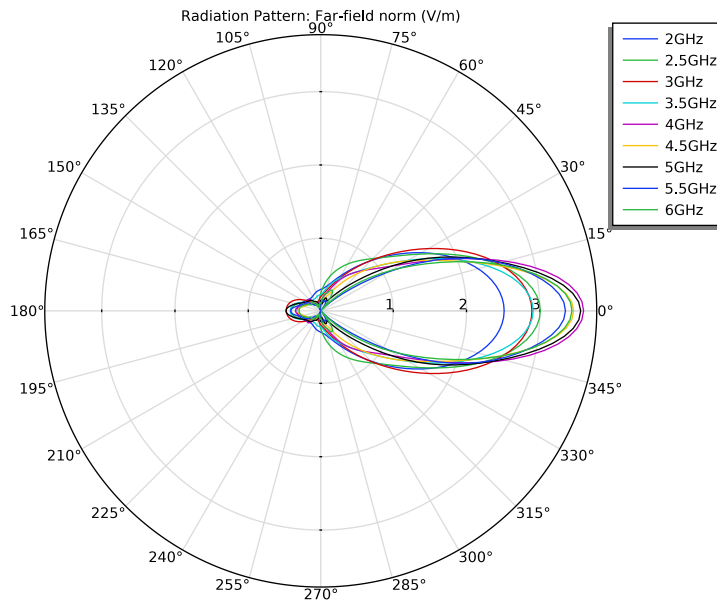

Radiation Pattern 1

- 1 In the **Model Builder** window, expand the **Results>3D Far Field, Gain (emw)** node, then click **Radiation Pattern 1**.
- 2 In the **Settings** window for **Radiation Pattern**, locate the **Evaluation** section.
- 3 Find the **Angles** subsection. In the **Number of elevation angles** text field, type 90.

- 4 In the **Number of azimuth angles** text field, type 90.
- 5 In the **3D Far Field, Gain (emw)** toolbar, click  **Plot**.

TABLE

- 1 Go to the **Table** window.
3D far-field radiation pattern is directive toward the aperture of the horn antenna (Figure 3).

RESULTS

ID Plot Group 6

- 1 In the **Home** toolbar, click  **Add Plot Group** and choose **ID Plot Group**.
- 2 In the **Settings** window for **ID Plot Group**, locate the **Data** section.
- 3 From the **Dataset** list, choose **Study 1/Parametric Solutions 1 (sol2)**.

Global 1

- 1 Right-click **ID Plot Group 6** and choose **Global**.
- 2 In the **Settings** window for **Global**, click **Add Expression** in the upper-right corner of the **y-Axis Data** section. From the menu, choose **Component 1 (comp1)> Electromagnetic Waves, Frequency Domain>Ports>emw.VSWR_1 - Voltage standing wave ratio**.
- 3 Locate the **x-Axis Data** section. From the **Axis source data** list, choose **Outer solutions**.
- 4 In the **ID Plot Group 6** toolbar, click  **Plot**.
Compare the resulting VSWR plot to Figure 4.

