



Branch-Line Coupler

Introduction

A branch line coupler, also known as a quadrature (90°) hybrid, is a four-port network device with one input port, two output ports, with a 90° phase difference between them, and one isolated port. Due to its symmetry, any port can be used as the input port.

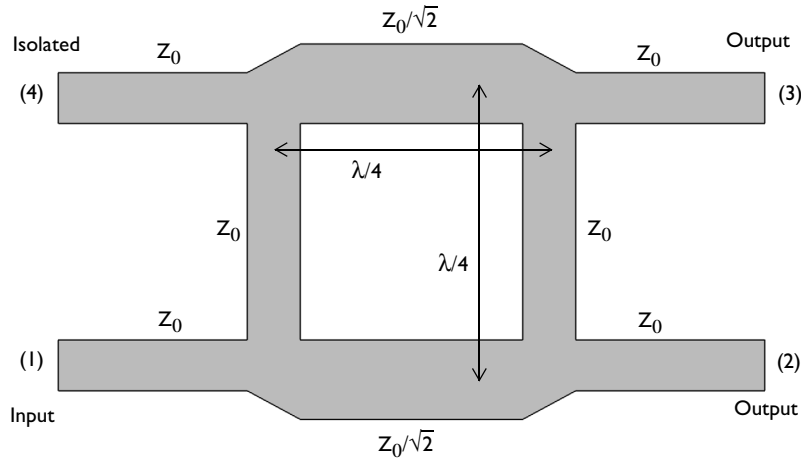

Figure 1: The geometry of a branch line coupler is symmetric.

Model Definition

The form of the branch line coupler is shown schematically in Figure 1. The layout design is based upon Ref. 1, and is tuned to operate at 3 GHz. The design is realized as microstrip lines patterned onto a 0.060 inch dielectric substrate. The microstrip lines are modeled as perfect electric conductor (PEC) surfaces, and another PEC surface on the bottom of the dielectric substrate acts as a ground plane. The entire modeling domain is bounded by PEC boundaries that represent the device packaging. The four ports are modeled as small

rectangular faces that bridge the gap between the PEC face that represents the ground plane, and the PEC faces that represent the microstrip line at each port.

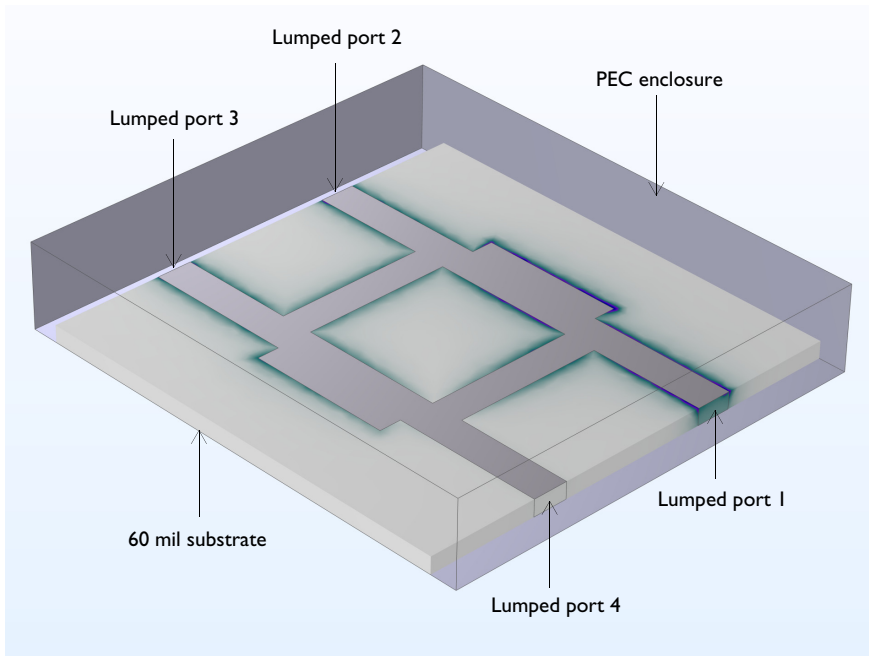

Figure 2: The model of the branch line coupler. Some exterior faces are removed for visualization.

The model is shown in [Figure 2](#). A small air domain bounded by a PEC surface around the device is also modeled. The model is meshed using a tetrahedral mesh. A good rule of thumb is to use approximately five elements per wavelength in each material. The physics-controlled mesh is used to generate the mesh automatically.

After the first study, the model is modified to utilize the SMA connector in the part library. The SMA connector with two holes at the flange is added at each end of the microstrip line and the type of lumped port is changed from uniform to coaxial.

Results and Discussion

The computed S-parameters are plotted in [Figure 3](#). At a frequency of 3 GHz, the signal is evenly split between the two output ports with a very small amount of losses. The input signal is barely coupled to the isolation port where S_{41} is less than -30 dB at 3 GHz. The evaluated phase shift between the two output ports is 89.9° .

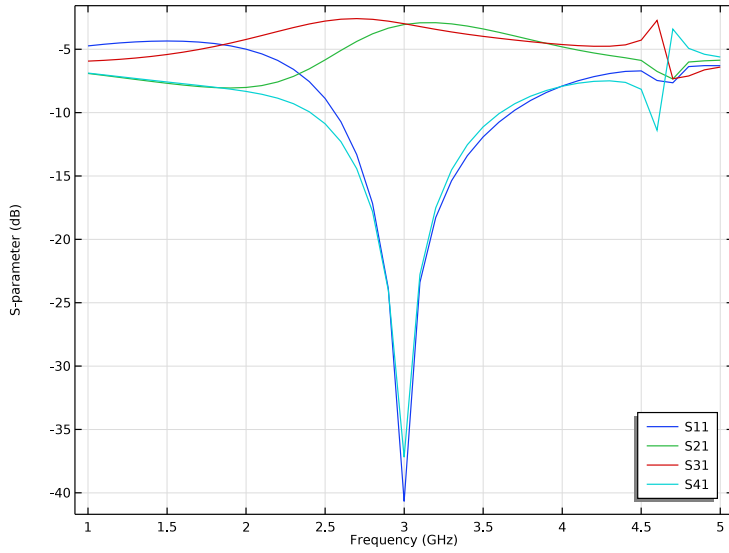

Figure 3: The frequency response of the branch line coupler shows good input matching (S_{11}) and isolation (S_{41}) around 3 GHz. The coupled signal at the two output ports (S_{21} and S_{31}) is about -3 dB at 3 GHz.

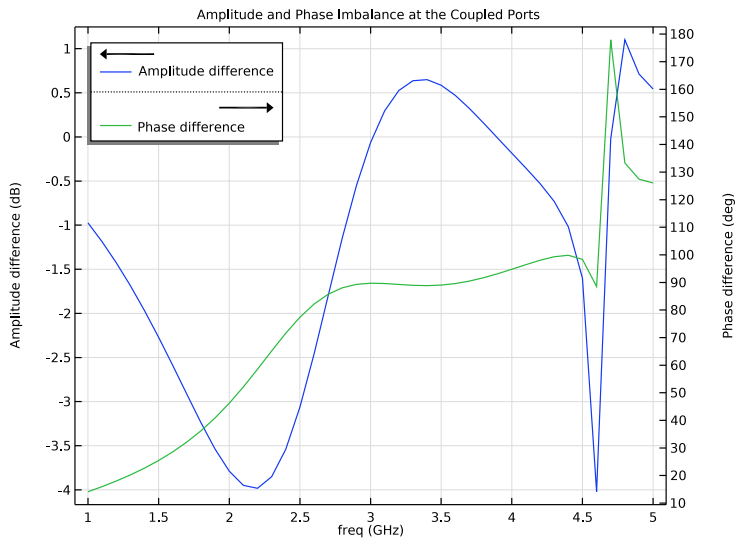

Figure 4: The amplitude and phase imbalance on the two output ports. The phase difference at 3 GHz is approximately 90 degrees.

Because the metallic housing works as a rectangular cavity, there is a resonance observed around 4.6 GHz. The resonant frequency of an air-filled hollow rectangular cavity is

$$f_{nml} = \frac{c}{2\pi\sqrt{\epsilon_r\mu_r}} \sqrt{\left(\frac{m\pi}{a}\right)^2 + \left(\frac{n\pi}{b}\right)^2 + \left(\frac{l\pi}{d}\right)^2}$$

where a and b are the dimensions of the sidewall of the cavity and d is the length of the cavity. The dominant resonant frequency at TE₁₀₁ mode is close to 5 GHz. Because the cavity is partially filled by the dielectric substrate, the resonance is expected lower than the that of the air-filled cavity. This resonance can easily be removed by adding a metallic post in the middle of the cavity connecting the bottom ground plane to the top ceiling if necessary.

The results after adding the SMA connectors are similar to those without the connectors and they are presented in the step by step instructions.

Reference

1. D.M. Pozar, *Microwave Engineering*, John Wiley & Sons, 1998.
-

Application Library path: RF_Module/Couplers_and_Power_Dividers/
branch_line_coupler



Modeling Instructions

From the **File** menu, choose **New**.

NEW

In the **New** window, click  **Model Wizard**.

MODEL WIZARD

- 1 In the **Model Wizard** window, click  **3D**.
- 2 In the **Select Physics** tree, select **Radio Frequency>Electromagnetic Waves, Frequency Domain (emw)**.
- 3 Click **Add**.
- 4 Click  **Study**.
- 5 In the **Select Study** tree, select **General Studies>Frequency Domain**.

6 Click  Done.

STUDY 1

Step 1: Frequency Domain

- 1 In the **Model Builder** window, under **Study 1** click **Step 1: Frequency Domain**.
- 2 In the **Settings** window for **Frequency Domain**, locate the **Study Settings** section.
- 3 In the **Frequencies** text field, type range(1[GHz],100[MHz],5[GHz]).

GLOBAL DEFINITIONS

Parameters 1

- 1 In the **Model Builder** window, under **Global Definitions** click **Parameters 1**.
- 2 In the **Settings** window for **Parameters**, locate the **Parameters** section.
- 3 In the table, enter the following settings:



Name	Expression	Value	Description
thickness	60[mil]	0.001524 m	Substrate thickness
l_s	40[mm]	0.04 m	Length, substrate
w_line2	5[mm]	0.005 m	Width, line 2
l_line2	13[mm]	0.013 m	Length, line 2
l_line1	$(l_s - l_line2) / 2$	0.0135 m	Length, line 1
w_line1	3.2[mm]	0.0032 m	Width, line 1
w_line3	3[mm]	0.003 m	Width, line 3
l_line3	13.6[mm]	0.0136 m	Length, line 3

Here, mil refers to the unit milliinch.

GEOMETRY 1

- 1 In the **Model Builder** window, under **Component 1 (comp1)** click **Geometry 1**.
- 2 In the **Settings** window for **Geometry**, locate the **Units** section.
- 3 From the **Length unit** list, choose **mm**.



Work Plane 1 (wp1)

- 1 In the **Geometry** toolbar, click  **Work Plane**, to add an *xy*-plane for the coupler layout'.
- 2 In the **Settings** window for **Work Plane**, click  **Show Work Plane**.



Work Plane 1 (wp1)>Plane Geometry

In the **Model Builder** window, click **Plane Geometry**.



Work Plane 1 (wp1)>Rectangle 1 (r1)

- 1 In the **Work Plane** toolbar, click  **Rectangle**.
- 2 In the **Settings** window for **Rectangle**, locate the **Size and Shape** section.
- 3 In the **Width** text field, type $2*w_line1+1_line3$.
- 4 In the **Height** text field, type 1_s .
- 5 Locate the **Position** section. From the **Base** list, choose **Center**.
- 6 Click  **Build Selected**.

Work Plane 1 (wp1)>Rectangle 2 (r2)

- 1 In the **Work Plane** toolbar, click  **Rectangle**.
- 2 In the **Settings** window for **Rectangle**, locate the **Size and Shape** section.
- 3 In the **Width** text field, type $w_line2*2+1_line3$.
- 4 In the **Height** text field, type 1_line2 .
- 5 Locate the **Position** section. From the **Base** list, choose **Center**.
- 6 In the **Work Plane** toolbar, click  **Build All**.

Work Plane 1 (wp1)>Rectangle 3 (r3)

- 1 In the **Work Plane** toolbar, click  **Rectangle**.
- 2 In the **Settings** window for **Rectangle**, locate the **Size and Shape** section.
- 3 In the **Width** text field, type 1_line3 .
- 4 In the **Height** text field, type 1_line2 .
- 5 Locate the **Position** section. In the **xw** text field, type $-1_line3/2$.
- 6 In the **yw** text field, type $1_line2/2+w_line3$.
- 7 Click  **Build Selected**.
- 8 Click the  **Zoom Extents** button in the **Graphics** toolbar.

Work Plane 1 (wp1)>Array 1 (arr1)

- 1 In the **Work Plane** toolbar, click  **Transforms** and choose **Array**.
- 2 Select the object **r3** only.
- 3 In the **Settings** window for **Array**, locate the **Size** section.
- 4 From the **Array type** list, choose **Linear**.
- 5 In the **Size** text field, type 3.

6 Locate the **Displacement** section. In the **yw** text field, type `-1_line2-w_line3`.

7 In the **Work Plane** toolbar, click  **Build All**.

Work Plane 1 (wp1)>Difference 1 (dif1)

1 In the **Work Plane** toolbar, click  **Booleans and Partitions** and choose **Difference**.

2 Select the objects **r1** and **r2** only.

3 In the **Settings** window for **Difference**, locate the **Difference** section.

4 Find the **Objects to subtract** subsection. Click to select the **Activate Selection** toggle button.

5 Select the objects **arr1(1)**, **arr1(2)**, and **arr1(3)** only, the three rectangles belonging to the array object (arr1).

6 Clear the **Keep interior boundaries** check box.

7 In the **Work Plane** toolbar, click  **Build All**.

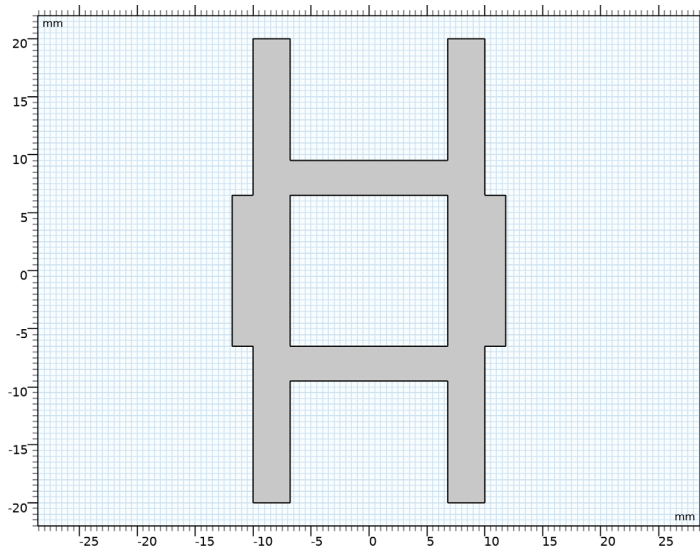

Work Plane 1 (wp1)



Extrude the *xy*-plane with the thickness of the substrate. Additional rectangular boundaries at each end of the feed lines are created by this extrusion, too. Use these boundaries to assign lumped ports later.

Extrude 1 (ext1)



1 In the **Model Builder** window, under **Component 1 (comp1)>Geometry 1** right-click **Work Plane 1 (wp1)** and choose **Extrude**.

- 2 In the **Settings** window for **Extrude**, locate the **Distances** section.
- 3 In the table, enter the following settings:



Distances (mm)
thickness

- 4 Click  **Build All Objects**.
 - 5 Click the  **Zoom Extents** button in the **Graphics** toolbar.
Choose wireframe rendering to get a better view of the interior parts.
 - 6 Click the  **Wireframe Rendering** button in the **Graphics** toolbar.
- Create a block for the substrate.

Block 1 (blk1)

- 1 In the **Geometry** toolbar, click  **Block**.
- 2 In the **Settings** window for **Block**, locate the **Size and Shape** section.
- 3 In the **Width** text field, type 1_s.
- 4 In the **Depth** text field, type 1_s.
- 5 In the **Height** text field, type thickness.
- 6 Locate the **Position** section. From the **Base** list, choose **Center**.
- 7 In the **z** text field, type thickness/2.
- 8 Click  **Build All Objects**.

Substrate

- 1 In the **Geometry** toolbar, click  **Booleans and Partitions** and choose **Union**.
- 2 In the **Settings** window for **Union**, type Substrate in the **Label** text field.
- 3 Locate the **Union** section. Clear the **Keep interior boundaries** check box.
- 4 Click in the **Graphics** window and then press Ctrl+A to select both objects.
- 5 Locate the **Selections of Resulting Entities** section. Select the **Resulting objects selection** check box.
- 6 Click  **Build All Objects**.

Package

- 1 In the **Geometry** toolbar, click  **Block**.
- 2 In the **Settings** window for **Block**, type Package in the **Label** text field.
- 3 Locate the **Size and Shape** section. In the **Width** text field, type 1_s.

- 4 In the **Depth** text field, type $1_s+1_s/8$.
- 5 In the **Height** text field, type $\text{thickness}*5$.
- 6 Locate the **Position** section. From the **Base** list, choose **Center**.
- 7 In the **z** text field, type $\text{thickness}*5/2$.
- 8 Click  **Build All Objects**.

The completed geometry describes the microstrip line device on a substrate enclosed by a metal housing.

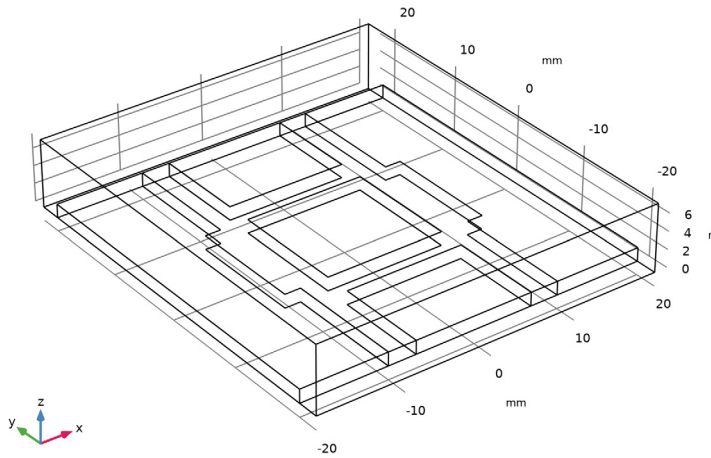

DEFINITIONS

View 1

Hide three boundaries to get a better view of the interior parts when reviewing the mesh.

Hide for Physics 1

- 1 In the **Model Builder** window, expand the **Component 1 (comp1)>Definitions** node.
- 2 Right-click **View 1** and choose **Hide for Physics**.
- 3 In the **Settings** window for **Hide for Physics**, locate the **Geometric Entity Selection** section.
- 4 From the **Geometric entity level** list, choose **Boundary**.

5 Select Boundaries 1, 2, and 4 only.

It might be easier to select the boundaries by using the **Selection List** window. To open this window, in the **Home** toolbar click **Windows** and choose **Selection List**. (If you are running the cross-platform desktop, you find **Windows** in the main menu.)

ELECTROMAGNETIC WAVES, FREQUENCY DOMAIN (EMW)

Now set up the physics. The default boundary condition is perfect electric conductor, which is applied to all exterior boundaries. Apply this condition also to the interior boundaries of the microstrip lines.

Perfect Electric Conductor 2

1 In the **Model Builder** window, under **Component 1 (comp1)** right-click **Electromagnetic Waves, Frequency Domain (emw)** and choose **Perfect Electric Conductor**.

2 Select Boundary 13 only.

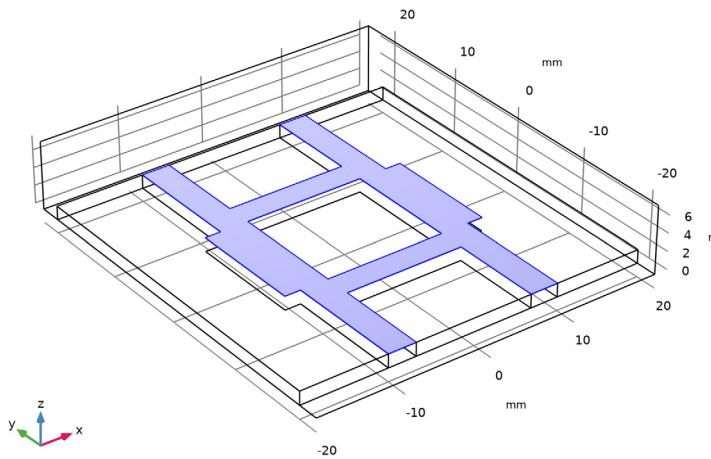

Lumped Port 1

1 In the **Physics** toolbar, click  **Boundaries** and choose **Lumped Port**.

2 Select Boundary 24 only.

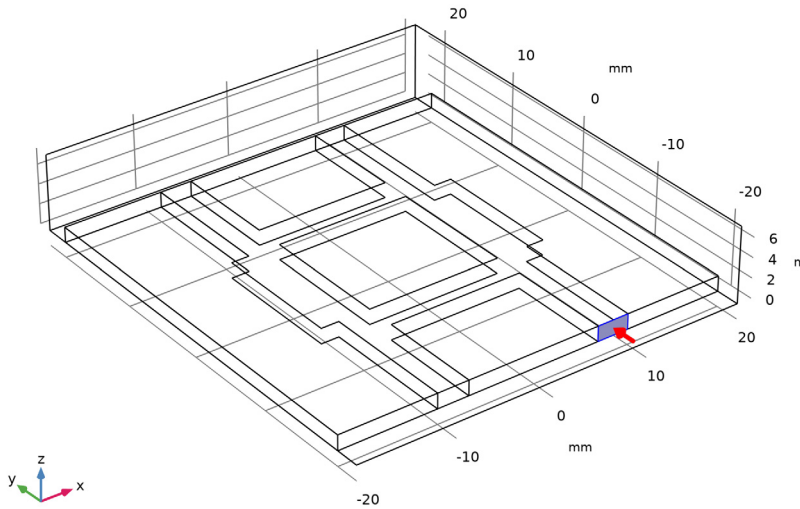

For the first port, wave excitation is **on** by default.

Lumped Port 2

1 In the **Physics** toolbar, click  **Boundaries** and choose **Lumped Port**.

2 Select Boundary 25 only.

Lumped Port 3

1 In the **Physics** toolbar, click  **Boundaries** and choose **Lumped Port**.

2 Select Boundary 15 only.

Lumped Port 4

1 In the **Physics** toolbar, click  **Boundaries** and choose **Lumped Port**.



2 Select Boundary 14 only.

Lumped ports are assigned at each end of the microstrip lines. Wave excitation is on only at the first port.

MATERIALS

Assign material properties to the model. First, apply air to all domains.

ADD MATERIAL

- 1 In the **Home** toolbar, click  **Add Material** to open the **Add Material** window.
- 2 Go to the **Add Material** window.
- 3 In the tree, select **Built-in>Air**.
- 4 Click **Add to Component** in the window toolbar.
- 5 In the **Home** toolbar, click  **Add Material** to close the **Add Material** window.

MATERIALS

Create a dielectric material of $\epsilon_r = 3.38$ overriding air in the substrate.

Substrate

- 1 In the **Model Builder** window, under **Component 1 (comp1)** right-click **Materials** and choose **Blank Material**.
- 2 In the **Settings** window for **Material**, type **Substrate** in the **Label** text field.
- 3 Locate the **Geometric Entity Selection** section. From the **Selection** list, choose **Substrate**.
- 4 Locate the **Material Contents** section. In the table, enter the following settings:

Property	Variable	Value	Unit	Property group
Relative permittivity	epsilon _{r_iso} ; epsilon _{r_ii} = epsilon _{r_iso} , epsilon _{r_ij} = 0	3.38		Basic
Relative permeability	mu _{r_iso} ; mu _{r_ii} = mu _{r_iso} , mu _{r_ij} = 0	1		Basic
Electrical conductivity	sigma _{iso} ; sigma _{ii} = sigma _{iso} , sigma _{ij} = 0	0	S/m	Basic

MESH 1

- 1 In the **Model Builder** window, under **Component 1 (comp1)** right-click **Mesh 1** and choose **Build All**.

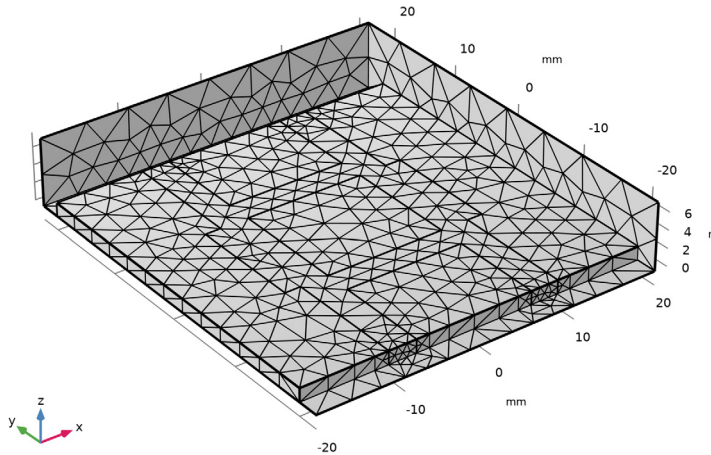

Three exterior boundaries are hidden in this view.

STUDY 1

- In the **Home** toolbar, click  **Compute**.

RESULTS

Electric Field (emw)

Begin the results analysis and visualization by modifying the first default plot to show the E-field norm in the middle of the substrate at 3 GHz.

- 1 In the **Settings** window for **3D Plot Group**, locate the **Data** section.
- 2 From the **Parameter value (freq (GHz))** list, choose **3**.

Multislice

- 1 In the **Model Builder** window, expand the **Electric Field (emw)** node, then click **Multislice**.
- 2 In the **Settings** window for **Multislice**, locate the **Multipane Data** section.
- 3 Find the **X-planes** subsection. In the **Planes** text field, type 0.
- 4 Find the **Y-planes** subsection. In the **Planes** text field, type 0.
- 5 Find the **Z-planes** subsection. From the **Entry method** list, choose **Coordinates**.

6 In the **Coordinates** text field, type $\text{thickness}/2$.

7 In the **Electric Field (emw)** toolbar, click  **Plot**.

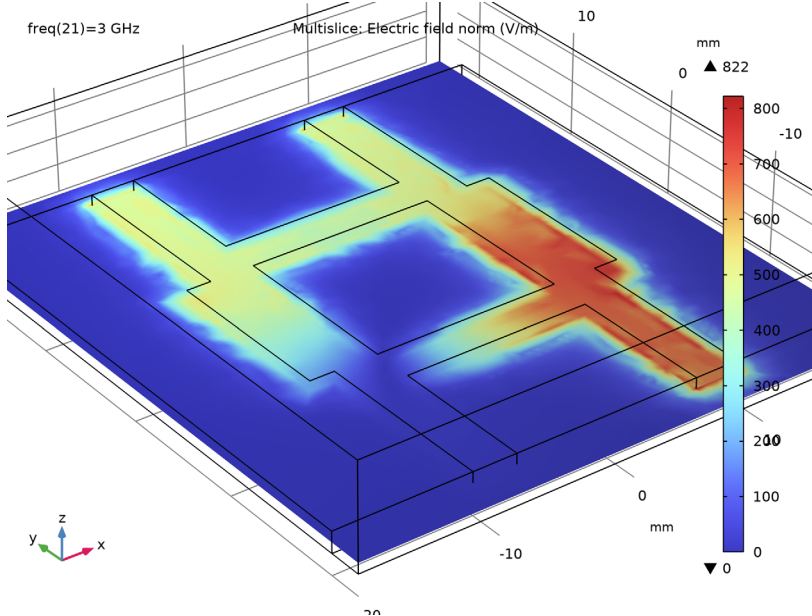

The input power is evenly split between the two output ports.

S-parameter (emw)

1 In the **Model Builder** window, under **Results** click **S-parameter (emw)**.

2 In the **Settings** window for **ID Plot Group**, click to expand the **Title** section.

3 Locate the **Legend** section. From the **Position** list, choose **Lower right**.

Compare the resulting plot with that shown in [Figure 3](#).

Smith Plot (emw)

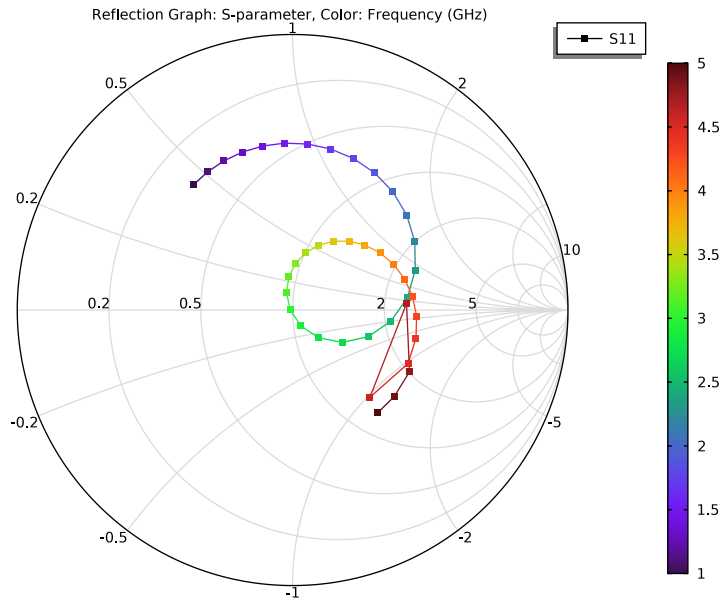

Plot the amplitude and phase imbalance on two output ports (Figure 4).

Imbalance

- 1 In the **Home** toolbar, click  **Add Plot Group** and choose **ID Plot Group**.
- 2 In the **Settings** window for **ID Plot Group**, type **Imbalance** in the **Label** text field.
- 3 Locate the **Title** section. From the **Title type** list, choose **Manual**.
- 4 In the **Title** text area, type **Amplitude and Phase Imbalance at the Coupled Ports**.
- 5 Locate the **Legend** section. From the **Position** list, choose **Upper left**.

Global 1

- 1 Right-click **Imbalance** and choose **Global**.
- 2 In the **Settings** window for **Global**, locate the **y-Axis Data** section.
- 3 In the table, enter the following settings:

Expression	Unit	Description
emw.S21dB-emw.S31dB	dB	Amplitude difference

Global 2

- 1 In the **Model Builder** window, right-click **Imbalance** and choose **Global**.
- 2 In the **Settings** window for **Global**, locate the **y-Axis Data** section.
- 3 In the table, enter the following settings:

Expression	Unit	Description
$\text{if}(\arg(\text{emw.S21}) - \arg(\text{emw.S31}) < 0, \arg(\text{emw.S21}) - \arg(\text{emw.S31}) + 360[\text{deg}], \arg(\text{emw.S21}) - \arg(\text{emw.S31}))$	deg	Phase difference

The unit is degree.

Imbalance

- 1 In the **Model Builder** window, click **Imbalance**.
- 2 In the **Settings** window for **ID Plot Group**, locate the **Plot Settings** section.
- 3 Select the **Two y-axes** check box.
- 4 In the table, select the **Plot on secondary y-axis** check box for **Global 2**.
- 5 In the **Imbalance** toolbar, click  **Plot**.

The phase difference between two output ports is approximately 90 degrees at 3 GHz.

Evaluate the phase difference between two output ports at 3 GHz.

Global Evaluation 1

- 1 In the **Results** toolbar, click  **Global Evaluation**.
- 2 In the **Settings** window for **Global Evaluation**, locate the **Data** section.
- 3 From the **Parameter selection (freq)** list, choose **From list**.
- 4 In the **Parameter values (freq (GHz))** list, select **3**.
- 5 Locate the **Expressions** section. In the table, enter the following settings:

Expression	Unit	Description
$\arg(\text{emw.S21}) - \arg(\text{emw.S31})$	°	

- 6 Click  **Evaluate**.

When the designed circuit is measured with a network analyzer, the circuit is connected to cables through connectors. Those connectors are not part of the network analyzer calibration process, and they may change the frequency response due to an additional reactive loading. By adding connectors, the simulation becomes closer to the real world

device. The RF part library helps to quickly add SMA connectors to the coupler without handling multiple geometry operations.

GLOBAL DEFINITIONS

Parameters 1

- 1 In the **Model Builder** window, under **Global Definitions** click **Parameters 1**.
- 2 In the **Settings** window for **Parameters**, locate the **Parameters** section.
- 3 In the table, enter the following settings:



Name	Expression	Value	Description
w_line2	5.2[mm]	0.0052 m	Width, line 2

GEOMETRY 1

Package (blk2)

- 1 In the **Model Builder** window, under **Component 1 (comp1)>Geometry 1** click **Package (blk2)**.
- 2 In the **Settings** window for **Block**, locate the **Position** section.
- 3 In the **z** text field, type $\text{thickness}+0.635$.
- 4 Locate the **Size and Shape** section. In the **Depth** text field, type 1_s .
- 5 In the **Height** text field, type 20.
- 6 Click  **Build Selected**.

PART LIBRARIES

- 1 In the **Home** toolbar, click  **Windows** and choose **Part Libraries**.
- 2 In the **Model Builder** window, click **Geometry 1**.
- 3 In the **Part Libraries** window, select **RF Module>Connectors>connector_sma_flange2** in the tree.
- 4 Click  **Add to Geometry**.

GEOMETRY 1

SMA Connector, Flange with Two Holes 1 (pi1)

- 1 In the **Model Builder** window, under **Component 1 (comp1)>Geometry 1** click **SMA Connector, Flange with Two Holes 1 (pi1)**.
- 2 In the **Settings** window for **Part Instance**, locate the **Input Parameters** section.

3 In the table, enter the following settings:

Name	Expression	Value	Description
$l_{\text{dielectric}}$	8 [mm]	8 mm	Length of dielectric
l_{pin}	1 [mm]	1 mm	Length of pin from flange

4 Locate the **Position and Orientation of Output** section. Find the **Displacement** subsection. In the **xw** text field, type -8.4.

5 In the **yw** text field, type $-1_s/2$.

6 In the **zw** text field, type thickness+0.635.

7 Find the **Rotation** subsection. In the **Rotation angle** text field, type 90.

8 Click to expand the **Domain Selections** section. In the table, enter the following settings:

Name	Keep	Physics	Contribute to
All		√	None
Dielectric	√	√	None
Conductor		√	None

9 Click to expand the **Boundary Selections** section. In the table, enter the following settings:

Name	Keep	Physics	Contribute to
Exterior		√	None
Conductive surface	√	√	None

10 Click  **Build All Objects**.

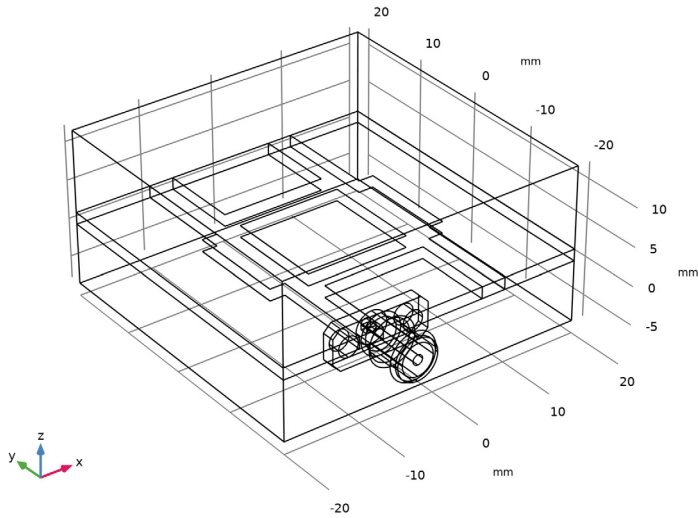

Copy 1 (copy1)

- 1 In the **Geometry** toolbar, click  **Transforms** and choose **Copy**.
- 2 Select the object **pi1** only.
- 3 In the **Settings** window for **Copy**, locate the **Displacement** section.
- 4 In the **x** text field, type 16.8.

Rotate 1 (rot1)

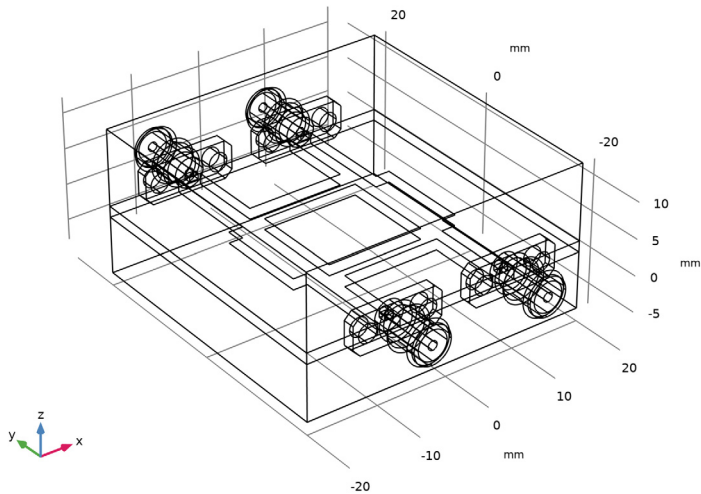

- 1 In the **Geometry** toolbar, click  **Transforms** and choose **Rotate**.
- 2 Select the objects **copy1** and **pi1** only.
- 3 In the **Settings** window for **Rotate**, locate the **Rotation** section.
- 4 In the **Angle** text field, type 0 180.

5 Click  **Build All Objects**.



The duplicated trace on the bottom ground plane can be removed as necessary. In this model, it is optional.

Form Composite Faces 1 (cmf1)

- 1 In the **Geometry** toolbar, click  **Virtual Operations** and choose **Form Composite Faces**.
- 2 On the object **fin**, select Boundaries 6, 44, 153, 156, 158, and 319 only.
- 3 In the **Geometry** toolbar, click  **Build All**.

ELECTROMAGNETIC WAVES, FREQUENCY DOMAIN (EMW)

Perfect Electric Conductor 2

- 1 In the **Model Builder** window, under **Component 1 (comp1)**>**Electromagnetic Waves**, **Frequency Domain (emw)** click **Perfect Electric Conductor 2**.
- 2 Select Boundaries 6 and 44 only.

Lumped Port 1

- 1 In the **Model Builder** window, click **Lumped Port 1**.
- 2 In the **Settings** window for **Lumped Port**, locate the **Boundary Selection** section.
- 3 Click  **Clear Selection**.

4 Select Boundary 234 only.

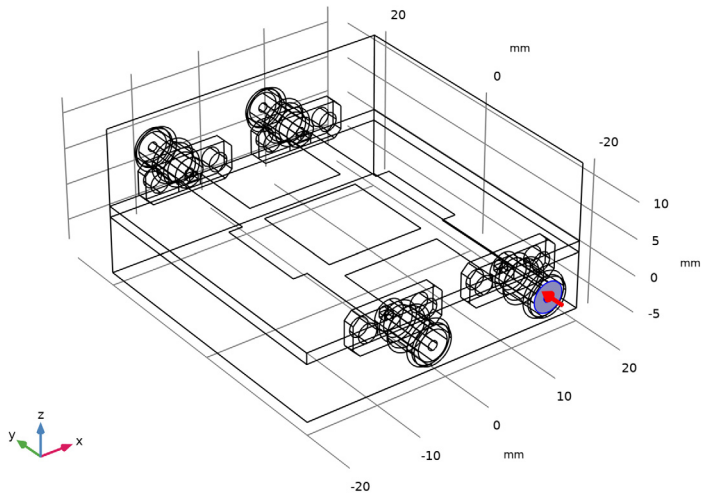

5 Locate the **Lumped Port Properties** section. From the **Type of lumped port** list, choose **Coaxial**.

Lumped Port 2

- 1 In the **Model Builder** window, click **Lumped Port 2**.
- 2 In the **Settings** window for **Lumped Port**, locate the **Boundary Selection** section.
- 3 Click  **Clear Selection**.
- 4 Select Boundary 243 only.
- 5 Locate the **Lumped Port Properties** section. From the **Type of lumped port** list, choose **Coaxial**.

Lumped Port 3

- 1 In the **Model Builder** window, click **Lumped Port 3**.
- 2 In the **Settings** window for **Lumped Port**, locate the **Boundary Selection** section.
- 3 Click  **Clear Selection**.
- 4 Select Boundary 80 only.
- 5 Locate the **Lumped Port Properties** section. From the **Type of lumped port** list, choose **Coaxial**.

Lumped Port 4

- 1 In the **Model Builder** window, click **Lumped Port 4**.

- 2 In the **Settings** window for **Lumped Port**, locate the **Boundary Selection** section.
- 3 Click  **Clear Selection**.
- 4 Select Boundary 71 only.
- 5 Locate the **Lumped Port Properties** section. From the **Type of lumped port** list, choose **Coaxial**.

Perfect Electric Conductor 3

- 1 In the **Physics** toolbar, click  **Boundaries** and choose **Perfect Electric Conductor**.
- 2 In the **Settings** window for **Perfect Electric Conductor**, locate the **Boundary Selection** section.
- 3 From the **Selection** list, choose **Conductive surface (SMA Connector, Flange with Two Holes 1)**.

MATERIALS

Material 3 (mat3)

- 1 In the **Model Builder** window, under **Component 1 (comp1)** right-click **Materials** and choose **Blank Material**.
- 2 In the **Settings** window for **Material**, locate the **Geometric Entity Selection** section.
- 3 From the **Selection** list, choose **Dielectric (SMA Connector, Flange with Two Holes 1)**.
- 4 Locate the **Material Contents** section. In the table, enter the following settings:

Property	Variable	Value	Unit	Property group
Relative permittivity	epsilon _n _iso ; epsilon _n ii = epsilon _n _iso, epsilon _n ij = 0	2.1		Basic
Relative permeability	mu _r _iso ; mu _r ii = mu _r _iso, mu _r ij = 0	1		Basic
Electrical conductivity	sigma _s _iso ; sigma _s ii = sigma _s _iso, sigma _s ij = 0	0	S/m	Basic

MESH 1

- 1 In the **Model Builder** window, under **Component 1 (comp1)** right-click **Mesh 1** and choose **Build All**.

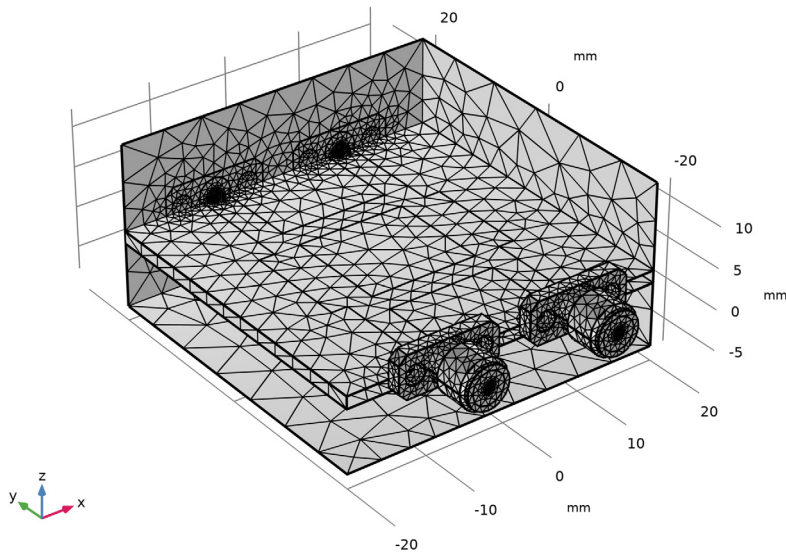

- 2 In the **Home** toolbar, click  **Compute**.

RESULTS

Multislice

- 1 In the **Model Builder** window, under **Results>Electric Field (emw)** click **Multislice**.
- 2 In the **Settings** window for **Multislice**, locate the **Coloring and Style** section.
- 3 From the **Color table** list, choose **HeatCameraLight**.
- 4 From the **Color table transformation** list, choose **Reverse**.

Surface 1

- 1 In the **Model Builder** window, right-click **Electric Field (emw)** and choose **Surface**.
- 2 In the **Settings** window for **Surface**, locate the **Coloring and Style** section.
- 3 From the **Color table** list, choose **AuroraAustralis**.
- 4 Clear the **Color legend** check box.

Selection 1

- 1 Right-click **Surface 1** and choose **Selection**.
- 2 In the **Settings** window for **Selection**, locate the **Selection** section.
- 3 From the **Selection** list, choose **Conductive surface (SMA Connector, Flange with Two Holes 1)**.
- 4 In the **Electric Field (emw)** toolbar, click  **Plot**.

freq(21)=3 GHz Multislice: Electric field norm (V/m) Surface: Electric field norm (V/m)

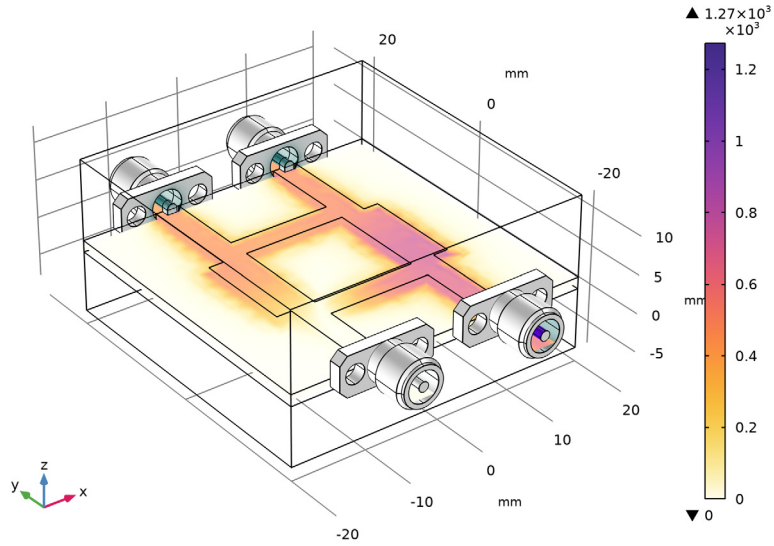

S-parameter (emw)

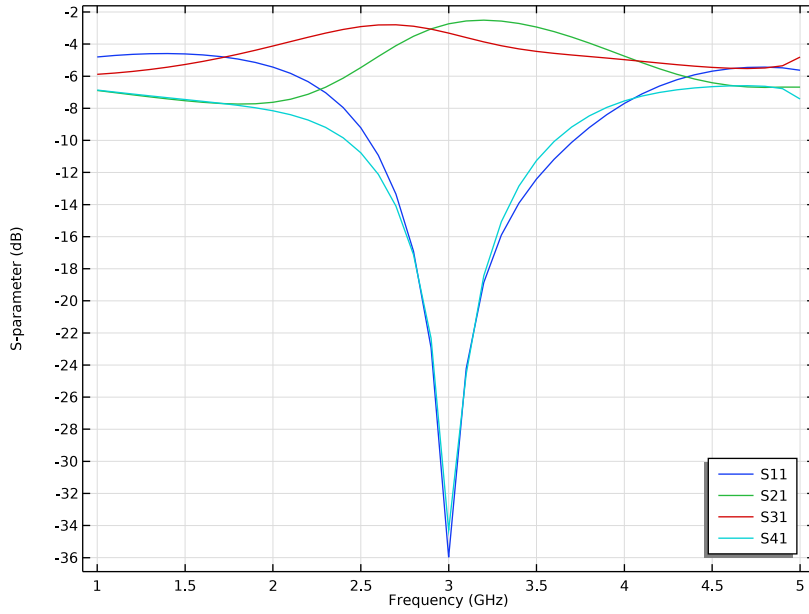

Smith Plot (emw)

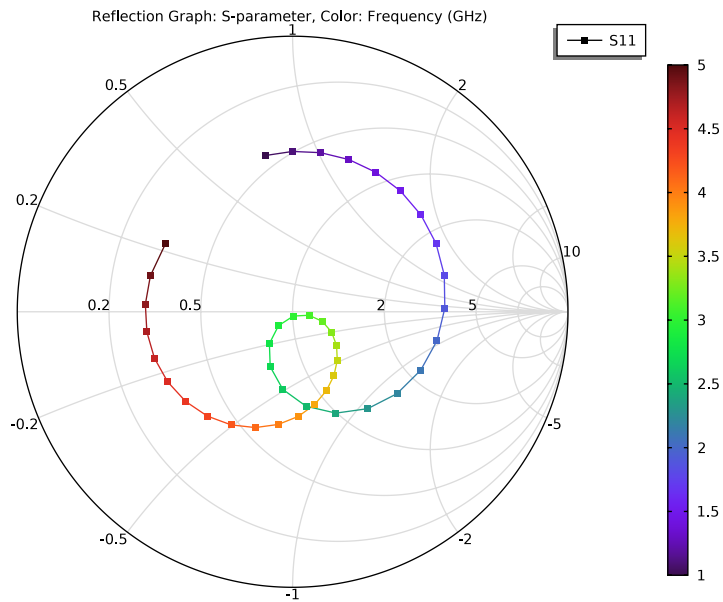

Imbalance

