



Estimating Permeability from Microscale Porous Structures

Introduction

This tutorial model demonstrates how to compute porosity and permeability of a sphere packing from a fully resolved microscopic model. These values are then used to model the sphere packing on the macroscopic scale using Darcy's Law.

Model Definition

The geometry used to calculate the permeability in the microscopic scale is shown in the figure below.

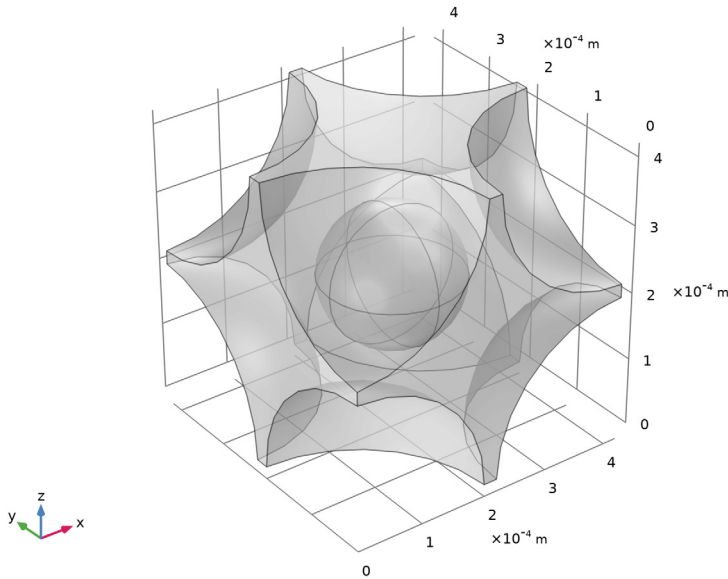

Figure 1: Geometry of the unit cell of a sphere packing.

A body-centered cubic (BCC) lattice is built with spheres of two different diameters. The flow around the spheres is described using the Creeping Flow interface. A pressure difference of 1 Pa is applied between inlet (top boundary) and outlet (bottom boundary). The boundaries that correspond to the solid-fluid interface are defined as walls and the remaining boundaries are symmetry boundaries.

From this set up the porosity and permeability can be calculated. The porosity is defined as the fraction of pore space volume V_{fluid} to total volume V_{tot}

$$\varepsilon = \frac{V_{\text{fluid}}}{V_{\text{tot}}}.$$

To calculate the permeability κ (m^2) the following relationship is used

$$\mathbf{u} = -\frac{\kappa}{\mu} \nabla p$$

whereas the pressure gradient ∇p is replaced by the pressure difference between inlet and outlet Δp divided by the size of the unit cell L and the velocity vector \mathbf{u} is replaced by the outlet velocity u_{out} in flow direction (z -direction), hence

$$\kappa = u_{\text{out}} \mu \frac{L}{\Delta p}.$$

The resulting values are then used to model the sphere packing on the macroscopic scale. The block height is 10 times larger than the height of the unit cell and the base area is 3 times larger.

To verify that a macroscopic approach using homogenization by deploying Darcy's Law gives accurate values, the model compares the mass flow per unit area (L^2).

Results and Discussion

The velocity field in the unit cell is shown in [Figure 2](#).

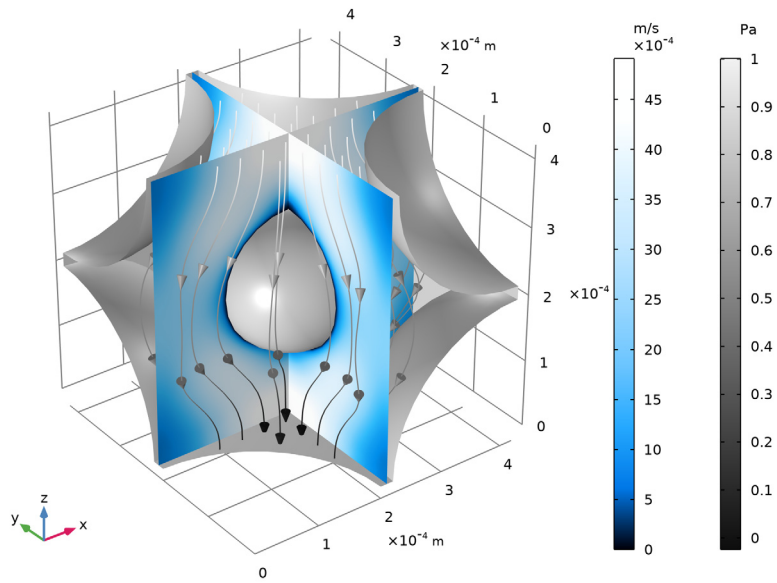

Figure 2: Velocity in the unit cell.

From the simulation the values for the porosity and permeability are obtained, with $\varepsilon = 0.49571$ and $\kappa \approx 3 \cdot 10^{-10} \text{ m}^2$.

Figure 3 shows the pressure distribution in the macroscopic model.

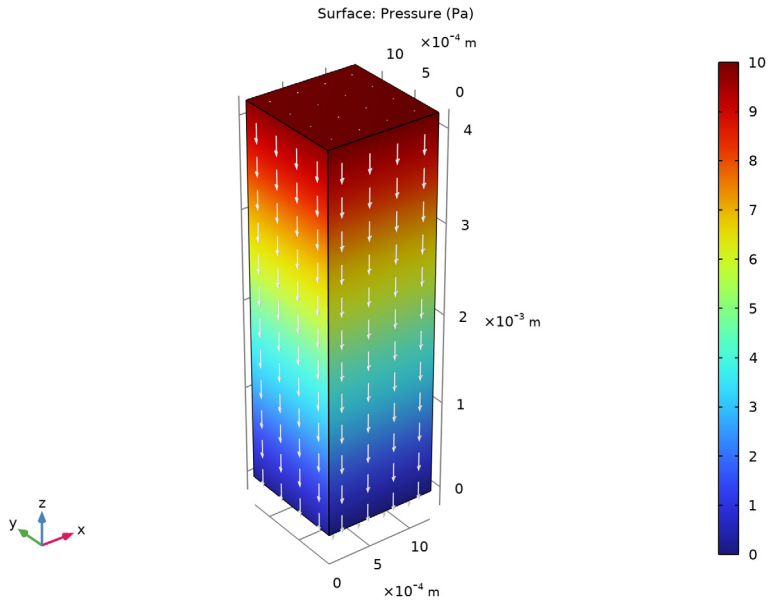

Figure 3: Pressure field for the macroscopic model.

The mass flow per unit area is about $0.72 \text{ kg}/(\text{m}^2 \cdot \text{s})$ in both models.

Application Library path: Porous_Media_Flow_Module/Fluid_Flow/permeability_estimation

Modeling Instructions

From the **File** menu, choose **New**.



NEW

In the **New** window, click  **Model Wizard**.

MODEL WIZARD



1 In the **Model Wizard** window, click  **3D**.

2 In the **Select Physics** tree, select **Fluid Flow>Single-Phase Flow>Creeping Flow (spf)**.

- 3 Click **Add**.
- 4 Click  **Study**.
- 5 In the **Select Study** tree, select **General Studies>Stationary**.
- 6 Click  **Done**.

GEOMETRY I

Insert the geometry sequence from a file.

- 1 In the **Geometry** toolbar, click **Insert Sequence** and choose **Insert Sequence**.
- 2 Browse to the model's Application Libraries folder and double-click the file `permeability_estimation_geom_sequence.mph`.
- 3 In the **Geometry** toolbar, click  **Build All**.
- 4 Click the  **Go to Default View** button in the **Graphics** toolbar.

Add some parameters to the **Parameters** list, that are used to set up the physics. The list already contains the parameters used to create the geometry and were imported automatically with the geometry sequence.

GLOBAL DEFINITIONS

Parameters I

- 1 In the **Model Builder** window, under **Global Definitions** click **Parameters I**.
- 2 In the **Settings** window for **Parameters**, locate the **Parameters** section.
- 3 In the table, enter the following settings:

Name	Expression	Value	Description
<code>p_in</code>	<code>1 [Pa]</code>	1 Pa	Inlet pressure
<code>rho_f</code>	<code>1000 [kg/m^3]</code>	1000 kg/m ³	Fluid density
<code>mu_f</code>	<code>1e-3 [Pa*s]</code>	0.001 Pa·s	Fluid viscosity

MATERIALS

Material I (mat1)

- 1 In the **Model Builder** window, under **Component I (comp1)** right-click **Materials** and choose **Blank Material**.
- 2 In the **Settings** window for **Material**, locate the **Material Contents** section.

3 In the table, enter the following settings:

Property	Variable	Value	Unit	Property group
Density	rho	rho_f	kg/m ³	Basic
Dynamic viscosity	mu	mu_f	Pa·s	Basic

CREEPING FLOW (SPF)

Inlet 1

- 1 In the **Model Builder** window, under **Component 1 (comp1)** right-click **Creeping Flow (spf)** and choose **Inlet**.
- 2 In the **Settings** window for **Inlet**, locate the **Boundary Condition** section.
- 3 From the list, choose **Pressure**.
- 4 Locate the **Pressure Conditions** section. In the p_0 text field, type p_{in} .
- 5 Select Boundary 6 only.

Outlet 1

- 1 In the **Physics** toolbar, click  **Boundaries** and choose **Outlet**.
- 2 Select Boundary 5 only.

Symmetry 1

- 1 In the **Physics** toolbar, click  **Boundaries** and choose **Symmetry**.
- 2 Select Boundaries 1, 2, 9, and 22 only.

Use the **Mass Properties** to create a variable for the fluid volume and add variables that calculate porosity and permeability.

DEFINITIONS

Mass Properties 1 (mass1)

- 1 In the **Model Builder** window, under **Component 1 (comp1)** right-click **Definitions** and choose **Physics Utilities>Mass Properties**.
- 2 Clear all check boxes, except the one for **Create volume variable**.

Variables 1

- 1 In the **Model Builder** window, right-click **Definitions** and choose **Variables**.
- 2 In the **Settings** window for **Variables**, locate the **Variables** section.

3 In the table, enter the following settings:

Name	Expression	Unit	Description
por	mass1.volume/L^3		Porosity
u_out	spf.out1.Mflow/rho_f/L^2	m/s	Outlet velocity
k0	u_out*mu_f*L/p_in	m ²	Permeability

MESH I

The physics-controlled mesh sets up a boundary layer mesh at the walls which ensures a good resolution of the steep velocity gradients in that region.

In the **Model Builder** window, under **Component 1 (comp1)** right-click **Mesh I** and choose **Build All**.

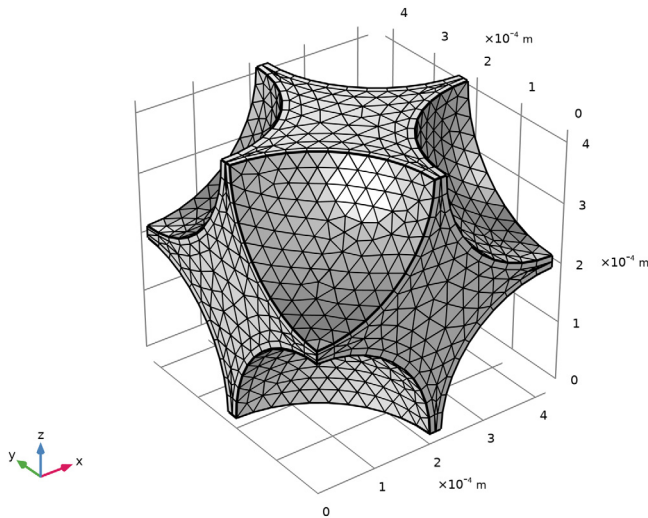

STUDY I

In the **Home** toolbar, click  **Compute**.

RESULTS

Slice

Two default plots are created automatically. Modify the velocity plot to obtain [Figure 2](#).

1 In the **Model Builder** window, expand the **Velocity (spf)** node, then click **Slice**.

- 2 In the **Settings** window for **Slice**, locate the **Plane Data** section.
- 3 In the **Planes** text field, type 1.
- 4 Locate the **Coloring and Style** section. From the **Color table** list, choose **JupiterAuroraBorealis**.

Slice 2

- 1 Right-click **Slice** and choose **Duplicate**.
- 2 In the **Settings** window for **Slice**, locate the **Plane Data** section.
- 3 From the **Plane** list, choose **zx-planes**.
- 4 In the **Planes** text field, type 1.
- 5 Click to expand the **Inherit Style** section. From the **Plot** list, choose **Slice**.
- 6 In the **Velocity (spf)** toolbar, click  **Plot**.

Surface 1

- 1 In the **Model Builder** window, right-click **Velocity (spf)** and choose **Surface**.
- 2 In the **Settings** window for **Surface**, locate the **Expression** section.
- 3 In the **Expression** text field, type 1.
- 4 Locate the **Coloring and Style** section. From the **Coloring** list, choose **Uniform**.
- 5 From the **Color** list, choose **Gray**.

Selection 1

- 1 Right-click **Surface 1** and choose **Selection**.
- 2 In the **Settings** window for **Selection**, locate the **Selection** section.

- From the **Selection** list, choose **All boundaries** and remove the top, bottom and front boundaries as shown below.

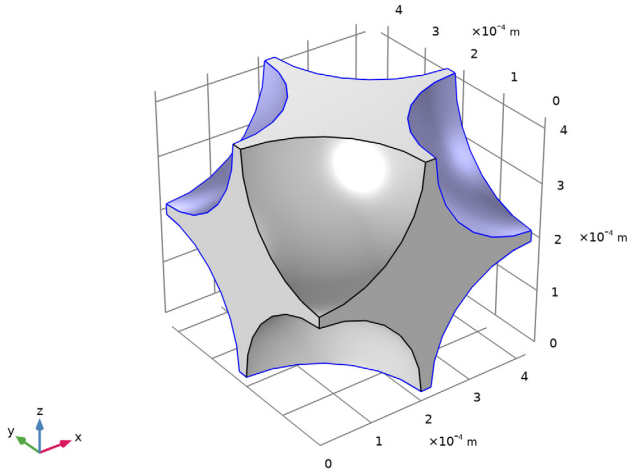

Streamline 1

- In the **Model Builder** window, right-click **Velocity (spf)** and choose **Streamline**.
- Select Boundary 6 only.
- In the **Settings** window for **Streamline**, locate the **Streamline Positioning** section.
- In the **Number** text field, type 40.
- Locate the **Coloring and Style** section. Find the **Point style** subsection. From the **Type** list, choose **Arrow**.
- Select the **Number of arrows** check box.
- In the associated text field, type 80.
- In the **Velocity (spf)** toolbar, click  **Plot**.



Color Expression 1

- Right-click **Streamline 1** and choose **Color Expression**.
- In the **Settings** window for **Color Expression**, locate the **Expression** section.
- In the **Expression** text field, type p .
- Locate the **Coloring and Style** section. From the **Color table** list, choose **GrayPrint**.

Velocity (spf)

- 1 In the **Model Builder** window, under **Results** click **Velocity (spf)**.
- 2 In the **Settings** window for **3D Plot Group**, click to expand the **Title** section.
- 3 From the **Title type** list, choose **None**.
- 4 Locate the **Plot Settings** section. Clear the **Plot dataset edges** check box.
- 5 Locate the **Color Legend** section. Select the **Show units** check box.
- 6 In the **Velocity (spf)** toolbar, click  **Plot**.

Global Evaluation 1

- 1 In the **Results** toolbar, click  **Global Evaluation**.
- 2 In the **Settings** window for **Global Evaluation**, click **Add Expression** in the upper-right corner of the **Expressions** section. From the menu, choose **Component 1 (comp1)>Definitions>Variables>k0 - Permeability - m²**.
- 3 Click **Add Expression** in the upper-right corner of the **Expressions** section. From the menu, choose **Component 1 (comp1)>Definitions>Variables>por - Porosity**.
- 4 Click  **Evaluate**.

TABLE

- 1 Go to the **Table** window.

The permeability is about 3^{-10}m^2 and the porosity is 0.49571.

ROOT



Now, add a new component to set up a Darcy's Law interface and use these values.

ADD COMPONENT



In the **Model Builder** window, right-click the root node and choose **Add Component>3D**.

GEOMETRY 2

Block 1 (blk1)

- 1 In the **Geometry** toolbar, click  **Block**.
- 2 In the **Settings** window for **Block**, locate the **Size and Shape** section.
- 3 In the **Width** text field, type $3*L$.
- 4 In the **Depth** text field, type $3*L$.
- 5 In the **Height** text field, type $10*L$.
- 6 Click  **Build All Objects**.

ADD PHYSICS

- 1 In the **Home** toolbar, click  **Add Physics** to open the **Add Physics** window.
- 2 Go to the **Add Physics** window.
- 3 In the tree, select **Fluid Flow>Porous Media and Subsurface Flow>Darcy's Law (dl)**.
- 4 Find the **Physics interfaces in study** subsection. In the table, clear the **Solve** check box for **Study 1**.
- 5 Click **Add to Component 2** in the window toolbar.
- 6 In the **Home** toolbar, click  **Add Physics** to close the **Add Physics** window.

DARCY'S LAW (DL)

Fluid 1

- 1 In the **Model Builder** window, under **Component 2 (comp2)>Darcy's Law (dl)>Porous Medium 1** click **Fluid 1**.
- 2 In the **Settings** window for **Fluid**, locate the **Fluid Properties** section.
- 3 From the ρ list, choose **User defined**. In the associated text field, type ρ_{of} .
- 4 From the μ list, choose **User defined**. In the associated text field, type μ_{of} .

Porous Matrix 1

- 1 In the **Model Builder** window, click **Porous Matrix 1**.
- 2 In the **Settings** window for **Porous Matrix**, locate the **Matrix Properties** section.
- 3 From the ϵ_p list, choose **User defined**. In the associated text field, type 0.49571.
- 4 From the κ list, choose **User defined**. In the associated text field, type 3.0292E-10.

Pressure 1

- 1 In the **Physics** toolbar, click  **Boundaries** and choose **Pressure**.
- 2 Select Boundary 4 only.



The macroscopic model is ten times larger in the direction of the pressure gradient than the unit cell. To compare the results of the unit cell with the results of the macroscopic model set the pressure to $10 \cdot p_{in}$.

- 3 In the **Settings** window for **Pressure**, locate the **Pressure** section.
- 4 In the p_0 text field, type $10 \cdot p_{in}$.

Pressure 2

- 1 In the **Physics** toolbar, click  **Boundaries** and choose **Pressure**.
- 2 Select Boundary 3 only.

ADD STUDY

- 1 In the **Home** toolbar, click  **Add Study** to open the **Add Study** window.
- 2 Go to the **Add Study** window.
- 3 Find the **Studies** subsection. In the **Select Study** tree, select **General Studies>Stationary**.
- 4 Disable the Creeping Flow interface for this study.
- 5 Click **Add Study** in the window toolbar.
- 6 In the **Home** toolbar, click  **Add Study** to close the **Add Study** window.

STUDY 2

- 1 In the **Model Builder** window, click **Study 2**.
- 2 In the **Home** toolbar, click  **Compute**.

RESULTS

Again default plots are created. Modify the pressure plot to obtain [Figure 3](#).

Arrow Surface 1

- 1 In the **Model Builder** window, right-click **Pressure (dl)** and choose **Arrow Surface**.
- 2 In the **Settings** window for **Arrow Surface**, click to expand the **Title** section.
- 3 From the **Title type** list, choose **None**.
- 4 Locate the **Coloring and Style** section. From the **Color** list, choose **White**.
- 5 In the **Pressure (dl)** toolbar, click  **Plot**.

Finally, compare the models using predefined mass flow variables. For the unit cell divide the variable by the area of the unit cell which is L^2 and not the area of the outlet boundary. For the macroscopic model use $(3*L)^2$. The resulting values should be almost identical.

Global Evaluation 2

- 1 In the **Results** toolbar, click  **Global Evaluation**.
- 2 In the **Settings** window for **Global Evaluation**, click **Replace Expression** in the upper-right corner of the **Expressions** section. From the menu, choose **Component 1 (comp1)>Creeping Flow>Auxiliary variables>spf.out1.massFlowRate - Outward mass flow rate across feature selection - kg/s**.
- 3 Locate the **Expressions** section. In the table, enter the following settings:

Expression	Unit	Description
$\text{spf.out1.massFlowRate}/L^2$	$\text{kg}/(\text{m}^2\cdot\text{s})$	Unit mass flow

4 Click  **Evaluate**.

Global Evaluation 3

- 1 In the **Results** toolbar, click  **Global Evaluation**.
- 2 In the **Settings** window for **Global Evaluation**, locate the **Data** section.
- 3 From the **Dataset** list, choose **Study 2/Solution 2 (3) (sol2)**.
- 4 Click **Replace Expression** in the upper-right corner of the **Expressions** section. From the menu, choose **Component 2 (comp2)>Darcy's Law>Mass flow>dl.pr2.Mflow - Mass flow - kg/s**.
- 5 Locate the **Expressions** section. In the table, enter the following settings:

Expression	Unit	Description
dl.pr2.Mflow/ (3*L) ^2	kg/ (m^2*s)	Unit mass flow

6 Click the **Evaluate** button. The results appear in the **Table** window.