

Slot Die Coating with Channel Defect

Introduction

Achieving uniform coating quality is important in several different industries: from optical coatings, semiconductor and electronics industry, through technologies utilizing thin membranes, to surface treatment of metals. Bad coating quality will compromise the performance of the products, or lead to complete failure in some cases.

Several different coating processes exist. This tutorial investigates the performance of a slot-die coating process, a so-called pre-metered coating method. In this process, the coating fluid is suspended from a thin slot die to a moving substrate. The final coating layer thickness is evaluated from the continuity relationship for a coating liquid. Therefore, the thickness of the liquid layer is determined by the slot gap, the coating fluid inlet velocity and the substrate speed.

The final goal of coating processes is to achieve a defect-free film of a desired thickness. However, manufacturing the uniform coating is not a trivial task, various flow instabilities or defects such as bubbles, ribbing, and rivulets are frequently observed in the process. The die geometry, the size of the slot and height above the substrate, together with the non-Newtonian fluid nature of the coating fluid are important to consider.

This tutorial demonstrates how to model the fluid flow in a polymer slot die coating process using the **Laminar Two-Phase Flow, Phase Field** interface and an inelastic non-Newtonian power law model for the polymer fluid.

Model Definition

MODEL GEOMETRY

A typical setup of the slot-die coating process is shown in [Figure 1](#).

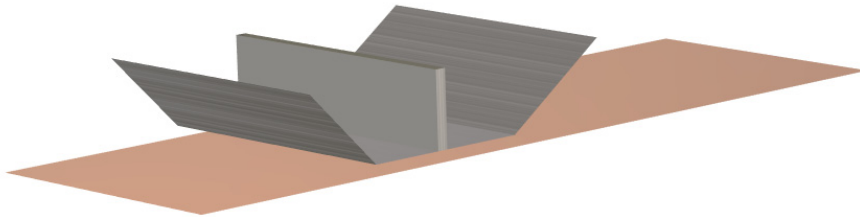

Figure 1: Typical geometry for a slot-die coating process with the slot die positioned over a substrate.

This example models the coating process in 3D where the inlet channel is obstructed (Figure 2).

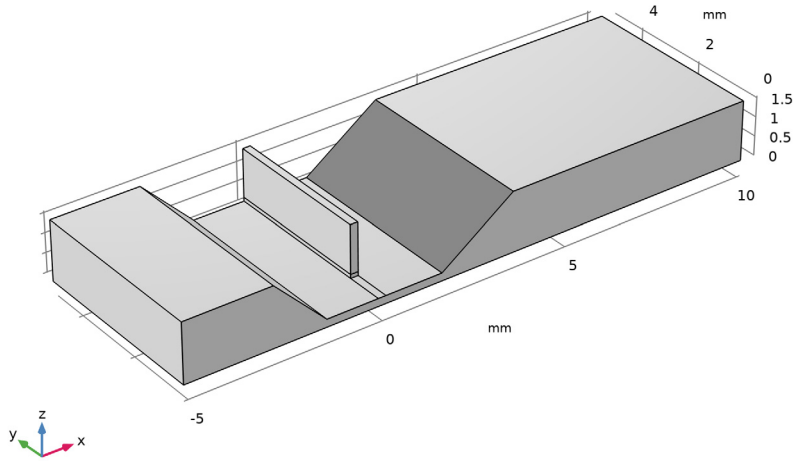

Figure 2: Model geometry.

More details about the model setup and COMSOL implementation can be found in the tutorial model *2D Non-Newtonian Slot Die Coating*.

Results

Figure 3 shows the evolution of the coating fluid interface for $t = 0.05$ s, $t = 0.1$ s, and $t = 0.2$ s.

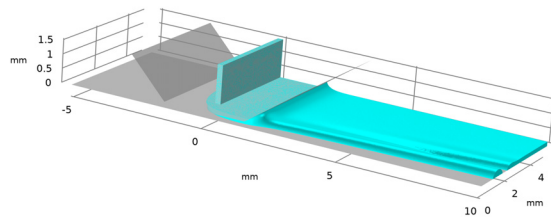
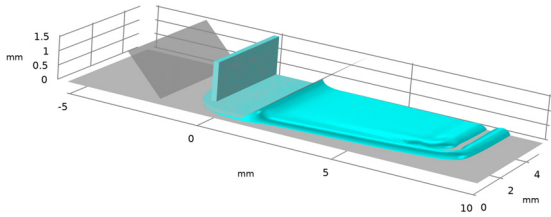
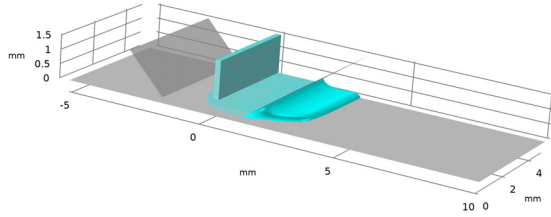

Figure 3: Fluid interface at $t = 0.03$ s, $t = 0.1$ s, and $t = 0.2$ s.

Figure 4 shows the variation of the film thickness across the outlet boundary. The channel defect leads to an uneven film thickness distribution. This can be partially mitigated by reducing the coating velocity.

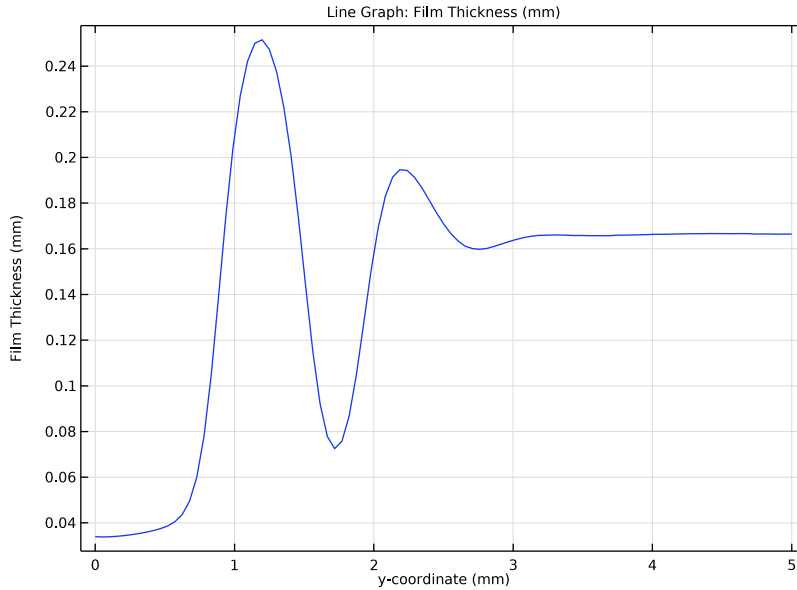

Figure 4: Coating film thickness across the outlet boundary.

Reference

1. K.L. Bhamidipati, *Detection and elimination of defects during manufacture of high-temperature polymer electrolyte membranes*, PhD Thesis, Georgia Institute of Technology, 2011

Application Library path: Polymer_Flow_Module/Tutorials/
slot_die_coating_3d



Modeling Instructions

From the **File** menu, choose **New**.

NEW

In the **New** window, click  **Model Wizard**.

MODEL WIZARD

- 1 In the **Model Wizard** window, click  **3D**.
- 2 In the **Select Physics** tree, select **Fluid Flow>Multiphase Flow>Two-Phase Flow, Phase Field>Laminar Flow**.
- 3 Click **Add**.
- 4 Click  **Study**.
- 5 In the **Select Study** tree, select **Preset Studies for Selected Multiphysics>Time Dependent with Phase Initialization**.
- 6 Click  **Done**.

GLOBAL DEFINITIONS

Parameters 1



- 1 In the **Model Builder** window, under **Global Definitions** click **Parameters 1**.
- 2 In the **Settings** window for **Parameters**, locate the **Parameters** section.
- 3 In the table, enter the following settings:

| Name | Expression | Value | Description |
|-----------|------------|-------------|-----------------------------|
| W | 0.2[mm] | 2E-4 m | Inlet width |
| Hc | 1.35[mm] | 0.00135 m | Inlet height |
| W_dd | 1.5[mm] | 0.0015 m | Die width downstream |
| W_ud | 1.35[mm] | 0.00135 m | Die width upstream |
| alpha_u | 45[deg] | 0.7854 rad | Upstream die angle |
| alpha_d | 55[deg] | 0.95993 rad | Downstream die angle |
| L_u | 5[mm] | 0.005 m | Upstream length |
| L_d | 10[mm] | 0.01 m | Downstream length |
| H | 0.2[mm] | 2E-4 m | Channel height |
| Thickness | 5[mm] | 0.005 m | Thickness |
| U_wall | 0.12[m/s] | 0.12 m/s | Sliding wall velocity |
| U_in | 0.1[m/s] | 0.1 m/s | Inlet velocity |
| L_notch | 1[mm] | 0.001 m | Length of channel end notch |

GEOMETRY I

- 1 In the **Model Builder** window, expand the **Component 1 (comp1)>Geometry 1** node, then click **Geometry 1**.
- 2 In the **Settings** window for **Geometry**, locate the **Units** section.
- 3 From the **Length unit** list, choose **mm**.

Work Plane 1 (wp1)

- 1 In the **Geometry** toolbar, click  **Work Plane**.
- 2 In the **Model Builder** window, click **Work Plane 1 (wp1)**.
- 3 In the **Settings** window for **Work Plane**, locate the **Plane Definition** section.
- 4 From the **Plane** list, choose **xz-plane**.
- 5 Click  **Build All Objects**.

Work Plane 1 (wp1)>Plane Geometry

In the **Model Builder** window, click **Plane Geometry**.

Work Plane 1 (wp1)>Rectangle 1 (r1)

- 1 In the **Work Plane** toolbar, click  **Rectangle**.
- 2 In the **Settings** window for **Rectangle**, locate the **Size and Shape** section.
- 3 In the **Width** text field, type W .
- 4 In the **Height** text field, type H_c .
- 5 Locate the **Position** section. In the **xw** text field, type $-W/2$.
- 6 In the **yw** text field, type H .
- 7 Click to expand the **Layers** section. In the table, enter the following settings:

| Layer name | Thickness (mm) |
|------------|----------------|
| Layer 1 | 0.1 |

Work Plane 1 (wp1)>Polygon 1 (pol1)

- 1 In the **Work Plane** toolbar, click  **Polygon**.
- 2 In the **Settings** window for **Polygon**, locate the **Coordinates** section.
- 3 In the table, enter the following settings:

| xw (mm) | yw (mm) |
|----------------------------------|---------|
| $-W/2$ | H |
| $-W/2-W_{ud}$ | H |
| $-W/2-W_{ud}-\tan(\alpha_u)*H_c$ | H_c+H |

| xw (mm) | yw (mm) |
|---------------------------------|----------------|
| $-W/2-L_u$ | H_c+H |
| $-W/2-L_u$ | 0 |
| $W/2+L_d$ | 0 |
| $W/2+L_d$ | H_c+H |
| $W/2+W_{dd}+\tan(\alpha_d)*H_c$ | H_c+H |
| $W/2+W_{dd}$ | H |

Extrude 1 (ext1)

- 1 In the **Model Builder** window, right-click **Geometry 1** and choose **Extrude**.
- 2 In the **Settings** window for **Extrude**, locate the **Distances** section.
- 3 In the table, enter the following settings:



| Distances (mm) |
|-----------------------|
| Thickness |

- 4 Select the **Reverse direction** check box.
- 5 Click  **Build All Objects**.

Block 1 (blk1)

- 1 In the **Geometry** toolbar, click  **Block**.
- 2 In the **Settings** window for **Block**, locate the **Size and Shape** section.
- 3 In the **Width** text field, type W.
- 4 In the **Depth** text field, type L_{notch} .
- 5 In the **Height** text field, type H_c .
- 6 Locate the **Position** section. In the **z** text field, type H.
- 7 In the **x** text field, type $-W/2$.

Difference 1 (dif1)

- 1 In the **Geometry** toolbar, click  **Booleans and Partitions** and choose **Difference**.
- 2 Select the object **ext1** only.
- 3 In the **Settings** window for **Difference**, locate the **Difference** section.
- 4 Find the **Objects to subtract** subsection. Click to select the  **Activate Selection** toggle button.
- 5 Select the object **blk1** only.

6 Click  **Build Selected.**

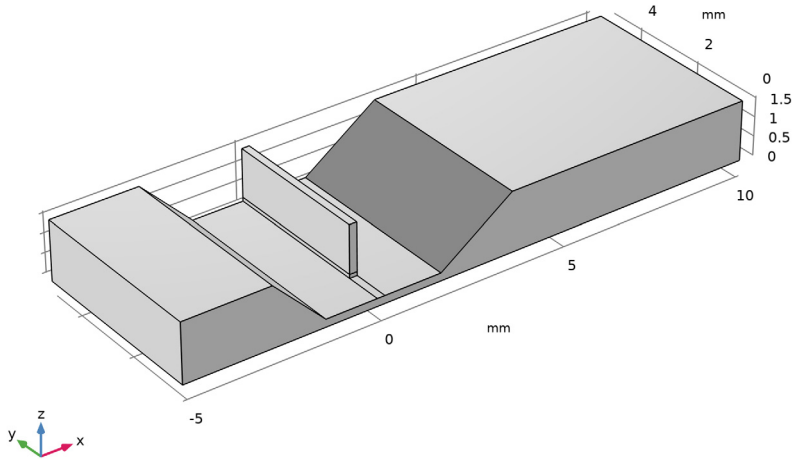

GLOBAL DEFINITIONS

Step 1 (step1)

- 1 In the **Home** toolbar, click  **Functions** and choose **Global>Step**.
- 2 In the **Settings** window for **Step**, locate the **Parameters** section.
- 3 In the **Location** text field, type 0.01.
- 4 Click to expand the **Smoothing** section. In the **Size of transition zone** text field, type 0.02.

MATERIALS

Air

- 1 In the **Model Builder** window, under **Component 1 (comp1)** right-click **Materials** and choose **Blank Material**.
- 2 In the **Settings** window for **Material**, type Air in the **Label** text field.

3 Locate the **Material Contents** section. In the table, enter the following settings:

| Property | Variable | Value | Unit | Property group |
|-------------------|----------|--------|-------------------|----------------|
| Density | rho | 1.2 | kg/m ³ | Basic |
| Dynamic viscosity | mu | 1.8e-5 | Pa·s | Basic |

Coating Fluid

1 Right-click **Materials** and choose **Blank Material**.

2 In the **Settings** window for **Material**, type **Coating Fluid** in the **Label** text field.

Go to the definition of the two phase model and select a non-newtonian power law model for the coating fluid. This will automatically enable the corresponding material parameters in the coating-fluid material.

MULTIPHYSICS

Two-Phase Flow, Phase Field 1 (tpf1)

1 In the **Model Builder** window, under **Component 1 (comp1)>Multiphysics** click **Two-Phase Flow, Phase Field 1 (tpf1)**.

2 In the **Settings** window for **Two-Phase Flow, Phase Field**, locate the **Fluid 1 Properties** section.

3 From the **Fluid 1** list, choose **Air (mat1)**.

4 Locate the **Fluid 2 Properties** section. From the **Fluid 2** list, choose **Coating Fluid (mat2)**.

5 Find the **Constitutive relation** subsection. From the list, choose **Inelastic non-Newtonian**.

6 Locate the **Surface Tension** section. From the **Surface tension coefficient** list, choose **User defined**. In the σ text field, type 0.049.

7 Click the  **Show More Options** button in the **Model Builder** toolbar.

8 In the **Show More Options** dialog box, select **Physics>Advanced Physics Options** in the tree.

9 In the tree, select the check box for the node **Physics>Advanced Physics Options**.

10 Click **OK**.

11 In the **Settings** window for **Two-Phase Flow, Phase Field**, click to expand the **Advanced Settings** section.

12 From the **Density averaging** list, choose **Heaviside function**.

13 In the l_p text field, type 0.9.

14 From the **Viscosity averaging** list, choose **Heaviside function**.

15 In the l_μ text field, type 0.9.

16 Select the **Shift surface tension force to the heaviest phase** check box.

To avoid spurious velocity and pressure oscillations due to the large density and viscosity ratios between the fluid, it can be advantageous to shift the surface tension force so that it is only applied in the heaviest phase. Note that this will reduce the computation time by several hours in this model.

MATERIALS

Coating Fluid (mat2)

- 1 In the **Model Builder** window, under **Component 1 (comp1)>Materials** click **Coating Fluid (mat2)**.
- 2 In the **Settings** window for **Material**, locate the **Material Contents** section.
- 3 In the table, enter the following settings:

| Property | Variable | Value | Unit | Property group |
|-------------------------------|----------|-------|-------------------|----------------|
| Density | rho | 1400 | kg/m ³ | Basic |
| Fluid consistency coefficient | m_pow | 7.77 | Pa·s | Power law |
| Flow behavior index | n_pow | 0.85 | | Power law |

LAMINAR FLOW (SPF)

Inlet 1

- 1 In the **Model Builder** window, under **Component 1 (comp1)** right-click **Laminar Flow (spf)** and choose **Inlet**.
- 2 Select Boundary 15 only.
- 3 In the **Settings** window for **Inlet**, locate the **Velocity** section.
- 4 In the U_0 text field, type $U_{in} \cdot \text{step1}(t[1/s])$.

Open Boundary 1

- 1 In the **Physics** toolbar, click  **Boundaries** and choose **Open Boundary**.
- 2 Select Boundaries 1 and 23 only.

Symmetry 1

- 1 In the **Physics** toolbar, click  **Boundaries** and choose **Symmetry**.
- 2 Select Boundaries 5, 16, and 17 only.

Wall 2

- 1 In the **Physics** toolbar, click  **Boundaries** and choose **Wall**.

- 2 Select Boundary 3 only.
- 3 In the **Settings** window for **Wall**, click to expand the **Wall Movement** section.
- 4 Select the **Sliding wall** check box.
- 5 Specify the \mathbf{u}_w vector as

| | |
|---|---|
| $U_{\text{wall}} * \text{step1}(t[1/\text{s}])$ | x |
| 0 | y |
| 0 | z |

PHASE FIELD (PF)

Initial Values, Fluid 2

- 1 In the **Model Builder** window, under **Component 1 (comp1)>Phase Field (pf)** click **Initial Values, Fluid 2**.
- 2 Select Domain 3 only.

Inlet 1

- 1 In the **Physics** toolbar, click  **Boundaries** and choose **Inlet**.
- 2 Select Boundary 15 only.
- 3 In the **Settings** window for **Inlet**, locate the **Phase Field Condition** section.
- 4 From the list, choose **Fluid 2** ($\varphi = 1$).

Wetted Wall 2

- 1 In the **Physics** toolbar, click  **Boundaries** and choose **Wetted Wall**.
- 2 Select Boundary 3 only.
- 3 In the **Settings** window for **Wetted Wall**, locate the **Wetted Wall** section.
- 4 In the θ_w text field, type 74[deg].

Wetted Wall 1

- 1 In the **Model Builder** window, click **Wetted Wall 1**.
- 2 In the **Settings** window for **Wetted Wall**, locate the **Wetted Wall** section.
- 3 In the θ_w text field, type 68.5[deg].

Symmetry 1

- 1 In the **Physics** toolbar, click  **Boundaries** and choose **Symmetry**.
- 2 Select Boundaries 5, 16, and 17 only.

Outlet 1

- 1 In the **Physics** toolbar, click  **Boundaries** and choose **Outlet**.
- 2 Select Boundaries 1 and 23 only.

MESH 1

- 1 In the **Model Builder** window, under **Component 1 (comp1)** click **Mesh 1**.
- 2 In the **Settings** window for **Mesh**, locate the **Sequence Type** section.
- 3 From the list, choose **User-controlled mesh**.

Size

- 1 In the **Model Builder** window, under **Component 1 (comp1)>Mesh 1** click **Size**.
- 2 In the **Settings** window for **Size**, locate the **Element Size** section.
- 3 Click the **Custom** button.
- 4 Locate the **Element Size Parameters** section. In the **Maximum element size** text field, type 5.2E-2.

Size 1

In the **Model Builder** window, under **Component 1 (comp1)>Mesh 1** right-click **Size 1** and choose **Delete**.

Compute the initial values. This will generate the default plots so that you can select which one to enable for plot while solving. Note that enabling plot while solving will increase the computation time for large models since time is spent on updating the selected plot in the graphical user interface after each solved time step. To reduce the computing time, disable plot while solving.

In the **Study** toolbar, click  **Get Initial Value**.

STUDY 1

Step 2: Time Dependent

- 1 In the **Model Builder** window, expand the **Study 1** node, then click **Step 2: Time Dependent**.
- 2 In the **Settings** window for **Time Dependent**, click to expand the **Results While Solving** section.
- 3 Select the **Plot** check box.
- 4 From the **Plot group** list, choose **Volume Fraction of Fluid 1 (pf)**.
- 5 From the **Update at** list, choose **Time steps taken by solver**.

- 6 Locate the **Study Settings** section. In the **Output times** text field, type range (0,0.05, .2).
- 7 In the **Study** toolbar, click  **Compute**.

RESULTS

- 1 In the **Model Builder** window, click **Results**.
- 2 In the **Settings** window for **Results**, locate the **Update of Results** section.
- 3 Select the **Only plot when requested** check box.

Coating film

- 1 In the **Home** toolbar, click  **Add Plot Group** and choose **3D Plot Group**.
- 2 Right-click **3D Plot Group 4** and choose **Rename**.
- 3 In the **Rename 3D Plot Group** dialog box, type *Coating film* in the **New label** text field.
- 4 Click **OK**.

Volume 1

- 1 In the **Model Builder** window, right-click **Coating film** and choose **Volume**.
- 2 In the **Settings** window for **Volume**, locate the **Expression** section.
- 3 In the **Expression** text field, type 1.
- 4 Locate the **Coloring and Style** section. From the **Coloring** list, choose **Uniform**.
- 5 From the **Color** list, choose **Cyan**.
- 6 Click to expand the **Title** section. From the **Title type** list, choose **Manual**.
- 7 In the **Title** text area, type *Coating fluid*.

Filter 1

- 1 Right-click **Volume 1** and choose **Filter**.
- 2 In the **Settings** window for **Filter**, locate the **Element Selection** section.
- 3 In the **Logical expression for inclusion** text field, type $pf.Vf2>0.5$.
- 4 In the **Coating film** toolbar, click  **Plot**.

Surface 1

In the **Model Builder** window, right-click **Coating film** and choose **Surface**.

Selection 1

- 1 In the **Model Builder** window, right-click **Surface 1** and choose **Selection**.
- 2 Select Boundary 2 only.
- 3 Click the  **Select All** button in the **Graphics** toolbar.

- 4 Select Boundaries 6–13, 15, 16, and 18–21 only.

Surface 1

- 1 In the **Model Builder** window, click **Surface 1**.
- 2 In the **Settings** window for **Surface**, locate the **Coloring and Style** section.
- 3 From the **Coloring** list, choose **Uniform**.
- 4 From the **Color** list, choose **Gray**.

Transparency 1

- 1 Right-click **Surface 1** and choose **Transparency**.
- 2 In the **Settings** window for **Transparency**, locate the **Transparency** section.
- 3 Set the **Transparency** value to **0.25**.

Surface 1

- 1 In the **Model Builder** window, click **Surface 1**.
- 2 In the **Settings** window for **Surface**, locate the **Expression** section.
- 3 In the **Expression** text field, type 1.
- 4 Click to expand the **Title** section. From the **Title type** list, choose **None**.

Surface 2

- 1 In the **Model Builder** window, right-click **Coating film** and choose **Surface**.
- 2 In the **Settings** window for **Surface**, locate the **Expression** section.
- 3 In the **Expression** text field, type 1.
- 4 Click to expand the **Title** section. From the **Title type** list, choose **None**.
- 5 Locate the **Coloring and Style** section. From the **Coloring** list, choose **Uniform**.
- 6 From the **Color** list, choose **Gray**.

Selection 1

- 1 Right-click **Surface 2** and choose **Selection**.
- 2 Select Boundary 3 only.
- 3 In the **Coating film** toolbar, click  **Plot**.







Coating film

- 1 In the **Model Builder** window, under **Results** click **Coating film**.
- 2 In the **Settings** window for **3D Plot Group**, locate the **Plot Settings** section.
- 3 Clear the **Plot dataset edges** check box.

To inspect the film thickness along the width of the outlet, you can use a nonlocal coupling operator, the linear projection operator. This operator integrates the projection of the expression on the surface toward the edge. Define this as shown in the following instructions.

DEFINITIONS

Linear Projection 1 (linproj1)

- 1 In the **Definitions** toolbar, click  **Nonlocal Couplings** and choose **Linear Projection**.
- 2 In the **Settings** window for **Linear Projection**, locate the **Source Selection** section.
- 3 From the **Geometric entity level** list, choose **Boundary**.
- 4 Select Boundary 23 only.
- 5 Locate the **Source Vertices** section. Click to select the  **Activate Selection** toggle button.
- 6 Select Point 28 only.
- 7 Click to select the  **Activate Selection** toggle button.
- 8 Select Point 30 only.
- 9 Click to select the  **Activate Selection** toggle button.
- 10 Select Point 27 only.
- 11 Locate the **Destination Vertices** section. Click to select the  **Activate Selection** toggle button.
- 12 Select Point 27 only.
- 13 Click to select the  **Activate Selection** toggle button.
- 14 Select Point 29 only.

Update the solution so that the newly defined operator is included.

STUDY 1

In the **Study** toolbar, click  **Update Solution**.

RESULTS

Film thickness

- 1 In the **Home** toolbar, click  **Add Plot Group** and choose **ID Plot Group**.
- 2 In the **Settings** window for **ID Plot Group**, locate the **Data** section.
- 3 From the **Time selection** list, choose **Last**.

4 In the **Label** text field, type `Film thickness`.

Line Graph 1

1 Right-click **Film thickness** and choose **Line Graph**.

2 Select Edge 47 only.

3 In the **Settings** window for **Line Graph**, locate the **y-Axis Data** section.

4 In the **Expression** text field, type `linproj1(pf.Vf2)`.

5 Locate the **x-Axis Data** section. From the **Parameter** list, choose **Expression**.

6 In the **Expression** text field, type `y`.

7 Locate the **y-Axis Data** section. From the **Unit** list, choose **mm**.

8 Locate the **x-Axis Data** section. From the **Unit** list, choose **mm**.

9 Locate the **y-Axis Data** section. Select the **Description** check box.

10 In the associated text field, type `Film Thickness`.

11 Click to expand the **Quality** section. From the **Resolution** list, choose **No refinement**.

12 In the **Film thickness** toolbar, click  **Plot**.

