

Rotating Channel

Introduction

A lab-on-a-chip platform can be realized on a rotating disc by designing channels and other features to use the Coriolis or centrifugal forces to manipulate the flow. These forces are controlled by changing the angular velocity of the disc, so the platform is programmed by using a controlled sequence of angular velocities. In a microchannel, the centrifugal force induces a parabolic flow profile pointing in the radial direction. This is analogous to a Poiseuille or pressure-driven flow. The velocity-dependent Coriolis force produces an inhomogeneous transverse force in the tangential direction, which has its highest value in the center of the channel. This results in a change in the pressure distribution from that of a standard Poiseuille flow, which is assessed in this model. Ref. 1 computes the pressure distribution in the channel as part of a benchmarking exercise, and the results computed by COMSOL compare well with those given in this paper.

Model Definition

The geometry consists of a square cross section channel of length 10 mm with side 200 μm (see Figure 1). The channel points in the radial direction and begins at a radius of 20 mm from the center of rotation of the disc.

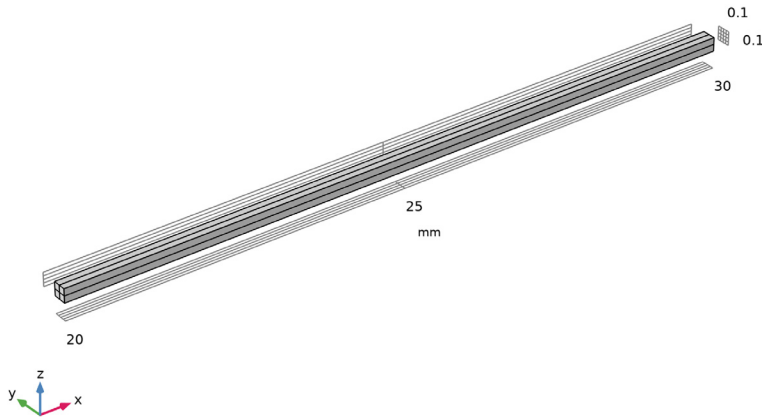

Figure 1: Model geometry. The radial direction corresponds to the x -direction.

Results and Discussion

Figure 2 shows the pressure along the channel axis. The results are in good agreement with those presented by Glatzel and others (Ref. 1). It should be noted that the inlet boundary

condition used by Glatzel and others is unphysical, because the Coriolis force acting at the inlet implies that there should be a pressure gradient in the y direction. Just as there is a pressure perpendicular to the flow when gravity acts in the perpendicular direction, so pressure gradients in the y direction are produced by the Coriolis force. This unphysical boundary condition accounts for the “kink” in the curve observed at the inlet and the complex pressure distribution at the inlet. Alternative approaches in this instance include using a point constraint on the pressure with the open boundary condition, explicitly including the pressure gradients in the pressure constraint and locating the inlet at the center of rotation of the disc. Because these methods invalidate comparisons with the results in [Ref. 1](#), this model uses the unphysical boundary condition.

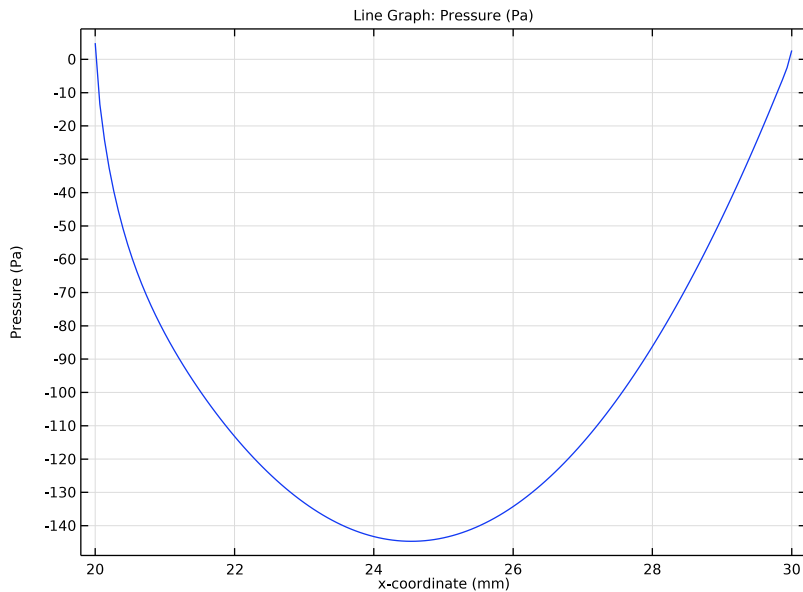

Figure 2: Pressure along the central axis of the channel.

The total flow rate through the channel is $14.9 \mu\text{l/s}$, in good agreement with the results in [Ref. 1](#).

Reference

1. T. Glatzel, C. Litterst, C. Cupelli, T. Lindemann, C. Moosmann, R. Niekrawietz, W. Streule, R. Zengerle, and P. Koltay, “Computational fluid dynamics (CFD) software tools

for microfluidic applications - A case study,” *Computers & Fluids*, vol. 37, pp. 218–235, 2008.

Notes About the COMSOL Implementation

The model is straightforward to set up using a Laminar Flow interface. The Coriolis and centrifugal forces are added explicitly as body forces.

Application Library path: Microfluidics_Module/Fluid_Flow/rotating_channel



Modeling Instructions

From the **File** menu, choose **New**.

NEW

In the **New** window, click  **Model Wizard**.

MODEL WIZARD

- 1 In the **Model Wizard** window, click  **3D**.
- 2 In the **Select Physics** tree, select **Fluid Flow>Single-Phase Flow>Laminar Flow (spf)**.
- 3 Click **Add**.
- 4 Click  **Study**.
- 5 In the **Select Study** tree, select **General Studies>Stationary**.
- 6 Click  **Done**.

GLOBAL DEFINITIONS

Parameters 1

- 1 In the **Model Builder** window, under **Global Definitions** click **Parameters 1**.
- 2 In the **Settings** window for **Parameters**, locate the **Parameters** section.
- 3 In the table, enter the following settings:

Name	Expression	Value	Description
omega	100[rad/s]	100 rad/s	Angular velocity



GEOMETRY I

- 1 In the **Model Builder** window, under **Component 1 (comp1)** click **Geometry I**.
- 2 In the **Settings** window for **Geometry**, locate the **Units** section.
- 3 From the **Length unit** list, choose **mm**.

Block 1 (blk1)

- 1 In the **Geometry** toolbar, click  **Block**.
- 2 In the **Settings** window for **Block**, locate the **Size and Shape** section.
- 3 In the **Width** text field, type 10.
- 4 In the **Depth** text field, type 0.1.
- 5 In the **Height** text field, type 0.1.
- 6 Locate the **Position** section. In the **x** text field, type 20.

Array 1 (arr1)

- 1 In the **Geometry** toolbar, click  **Transforms** and choose **Array**.
- 2 Select the object **blk1** only.
- 3 In the **Settings** window for **Array**, locate the **Size** section.
- 4 In the **y size** text field, type 2.
- 5 In the **z size** text field, type 2.
- 6 Locate the **Displacement** section. In the **y** text field, type 0.1.
- 7 In the **z** text field, type 0.1.
- 8 Click  **Build All Objects**.
- 9 Click the  **Zoom Extents** button in the **Graphics** toolbar.

MATERIALS

Material 1 (mat1)

- 1 In the **Model Builder** window, under **Component 1 (comp1)** right-click **Materials** and choose **Blank Material**.
- 2 In the **Settings** window for **Material**, locate the **Material Contents** section.

3 In the table, enter the following settings:

Property	Variable	Value	Unit	Property group
Density	rho	977	kg/m ³	Basic
Dynamic viscosity	mu	8.55e-4	Pa·s	Basic



The large aspect ratio of the channel is not practical for creating the model. To continue more easily, it is useful to define a different view.

DEFINITIONS

View 2

- 1 In the **Model Builder** window, under **Component 1 (comp1)** right-click **Definitions** and choose **View**.
- 2 In the **Model Builder** window, click **View 2**.
- 3 In the **Settings** window for **View**, locate the **View** section.
- 4 Select the **Wireframe rendering** check box.

Camera

- 1 In the **Model Builder** window, click **Camera**.
- 2 In the **Settings** window for **Camera**, locate the **Camera** section.
- 3 From the **View scale** list, choose **Automatic**.
- 4 From the **Automatic** list, choose **Anisotropic**.
- 5 In the **x weight** text field, type 6.
- 6 Click  **Update**.
- 7 Click the  **Zoom Extents** button in the **Graphics** toolbar.

Define a nonlocal integration coupling for the outlet boundary.

Integration 1 (intop1)

- 1 In the **Definitions** toolbar, click  **Nonlocal Couplings** and choose **Integration**.
- 2 In the **Settings** window for **Integration**, locate the **Source Selection** section.
- 3 From the **Geometric entity level** list, choose **Boundary**.
- 4 Select Boundaries 17–20 only.

Variables 1

- 1 In the **Definitions** toolbar, click  **Local Variables**.
- 2 In the **Settings** window for **Variables**, locate the **Variables** section.

3 In the table, enter the following settings:

Name	Expression	Unit	Description
Q	intop1(u)	m ³ /s	Total flow rate

LAMINAR FLOW (SPF)

Volume Force 1

- 1 In the **Model Builder** window, under **Component 1 (comp1)** right-click **Laminar Flow (spf)** and choose **Volume Force**.
- 2 In the **Settings** window for **Volume Force**, locate the **Domain Selection** section.
- 3 From the **Selection** list, choose **All domains**.
- 4 Locate the **Volume Force** section. Specify the \mathbf{F} vector as

spf.rho*x*omega^2	x
0	y
0	z

Volume Force 2

- 1 In the **Physics** toolbar, click  **Domains** and choose **Volume Force**.
- 2 In the **Settings** window for **Volume Force**, locate the **Domain Selection** section.
- 3 From the **Selection** list, choose **All domains**.
- 4 Locate the **Volume Force** section. Specify the \mathbf{F} vector as

0	x
2*spf.rho*omega*u	y
0	z

Open Boundary 1

- 1 In the **Physics** toolbar, click  **Boundaries** and choose **Open Boundary**.

2 Select Boundaries 1, 4, 8, 11, and 17–20 only.

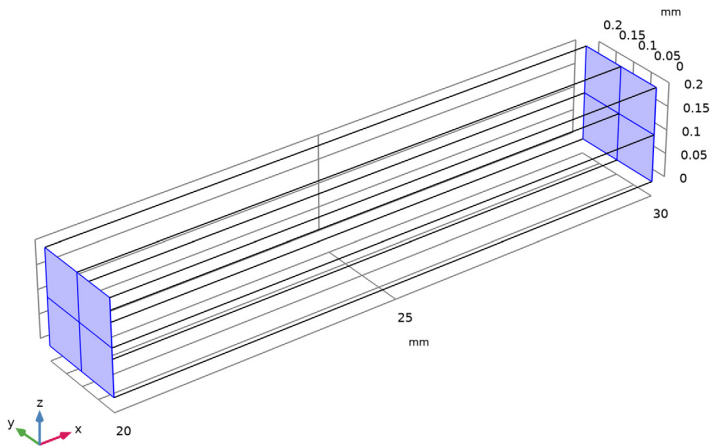

MESH I

Mapped I

1 In the **Mesh** toolbar, click  **Boundary** and choose **Mapped**.

2 Select Boundaries 1, 4, 8, and 11 only.

Distribution I

1 Right-click **Mapped I** and choose **Distribution**.

2 Select Edges 1, 2, 4, 5, 7, 9, 10, 12, 13, 15, 17, and 19 only.

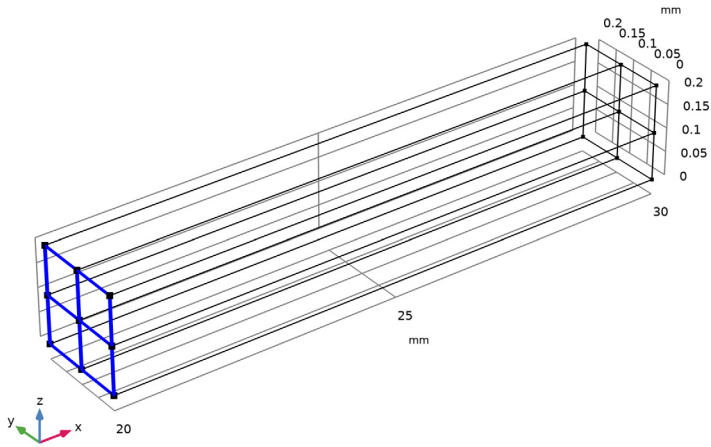

Swept 1

In the **Mesh** toolbar, click  **Swept**.

Distribution 1

- 1 Right-click **Swept 1** and choose **Distribution**.
- 2 In the **Settings** window for **Distribution**, locate the **Distribution** section.
- 3 In the **Number of elements** text field, type 150.

4 Click  **Build All**.

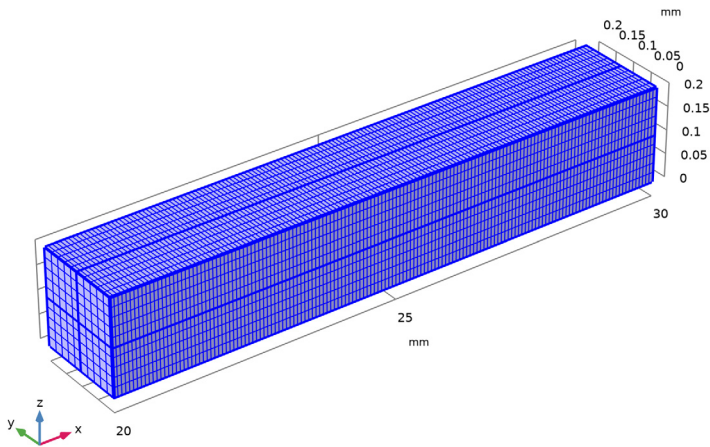

STUDY I

In the **Home** toolbar, click  **Compute**.

RESULTS

Unlike pressure-driven flows, the pressure drop along the channel is not linear. Add a 3D edge dataset to enable the creation of a pressure line plot.

Edge 3D I

1 In the **Results** toolbar, click  **More Datasets** and choose **Edge 3D**.

2 Select Edge 14 only.

Pressure drop

1 In the **Results** toolbar, click  **ID Plot Group**.

2 In the **Settings** window for **ID Plot Group**, type Pressure drop in the **Label** text field.

3 Locate the **Data** section. From the **Dataset** list, choose **Edge 3D I**.

Line Graph I

1 Right-click **Pressure drop** and choose **Line Graph**.

2 In the **Settings** window for **Line Graph**, click **Replace Expression** in the upper-right corner of the **y-Axis Data** section. From the menu, choose **Component I (comp1)>Laminar Flow>Velocity and pressure>p - Pressure - Pa**.

3 Click **Replace Expression** in the upper-right corner of the **x-Axis Data** section. From the menu, choose **Component 1 (comp1)>Geometry>Coordinate>x - x-coordinate**.

4 In the **Pressure drop** toolbar, click  **Plot**.

Compare the result with [Figure 2](#).

Finally, evaluate the total flow rate.

Global Evaluation 1

1 In the **Results** toolbar, click  **Global Evaluation**.

2 In the **Settings** window for **Global Evaluation**, click **Replace Expression** in the upper-right corner of the **Expressions** section. From the menu, choose **Component 1 (comp1)>Definitions>Variables>Q - Total flow rate - m³/s**.

3 Locate the **Expressions** section. In the table, enter the following settings:

Expression	Unit	Description
Q	dm ³ /s	Total flow rate

4 Click  **Evaluate**.

TABLE

1 Go to the **Table** window.

1.56e-5 dm³/s corresponds to 15.6 μl/s.

