



# Piezoresistive Pressure Sensor

## *Introduction*

---

Piezoresistive pressure sensors were some of the first MEMS devices to be commercialized. Compared to capacitive pressure sensors, they are simpler to integrate with electronics, their response is more linear, and they are inherently shielded from RF noise. They do, however, usually require more power during operation, and the fundamental noise limits of the sensor are higher than their capacitive counterparts. Historically, piezoresistive devices have been dominant in the pressure sensor market.

This example considers the design of the MPX100 series pressure sensors originally produced by the semiconductor products division of Motorola Inc. (now Freescale Semiconductor Inc.). Although the sensor is no longer in production, a detailed analysis of its design is given in [Ref. 1](#), and an archived data sheet is available from Freescale Semiconductor Inc. ([Ref. 2](#)).

## *Model Definition*

---

The model consists square membrane with side 1 mm and thickness 20  $\mu\text{m}$ , supported around its edges by region 0.1mm wide, which is intended to represent the remainder of the wafer. The supporting region is fixed on its underside (representing a connection to the thicker handle of the device die). Near to one edge of the membrane an X-shaped piezoresistor (or Xducer<sup>TM</sup>)<sup>1</sup> and part of its associated interconnects are visible. The geometry is shown in [Figure 1](#).

The piezoresistor is assumed to have a uniform p-type dopant density of  $1.32 \times 10^{19} \text{ cm}^{-3}$  and a thickness of 400 nm. The interconnects are assumed to have the same thickness but a dopant density of  $1.45 \times 10^{20} \text{ cm}^{-3}$ . Only a part of the interconnects is included in the geometry, since their conductivity is sufficiently high that they do not contribute to the voltage output of the device (in practice the interconnects would also be thicker in addition to having a higher conductivity but this also has little effect on the solution).

The edges of the die are aligned with the {110} directions of the silicon. The die edges are also aligned with the global  $X$  and  $Y$  axes in the COMSOL Multiphysics model. The piezoresistor is oriented at 45 to the die edge, and so lies in the [100] direction of the

---

1. Xducer<sup>TM</sup> is believed to be a trademark of Freescale Semiconductor, Inc. f/k/a Motorola, Inc. Neither Freescale Semiconductor Inc. nor Motorola, Inc. has in any way provided any sponsorship or endorsement of, nor do they have any connection or involvement with, COMSOL Multiphysics® software or this model.

crystal. In the COMSOL Multiphysics model, a coordinate system rotated 45° about the global Z-axis is added to define the orientation of the crystal.

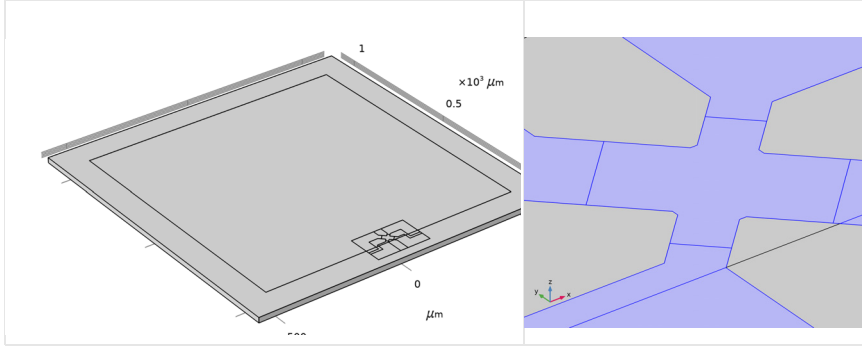

Figure 1: Left: Model geometry. Right: Detail showing the piezoresistor geometry.

#### DEVICE PHYSICS AND EQUATIONS

The conductivity of the Xducer™ sensor changes when the membrane in its vicinity is subject to an applied stress. This effect is known as the piezoresistance effect and is usually associated with semiconducting materials. In semiconductors, piezoresistance results from the strain-induced alteration of the material's band structure, and the associated changes in carrier mobility and number density. The relation between the electric field,  $\mathbf{E}$ , and the current,  $\mathbf{J}$ , within a piezoresistor is:

$$\mathbf{E} = \rho \cdot \mathbf{J} + \Delta\rho \cdot \mathbf{J} \quad (1)$$

where  $\rho$  is the resistivity and  $\Delta\rho$  is the induced change in the resistivity. In the general case both  $\rho$  and  $\Delta\rho$  are rank 2 tensors (matrices). The change in resistance is related to the stress,  $\sigma$ , by the constitutive relationship:

$$\Delta\rho = \Pi \cdot \sigma \quad (2)$$

where  $\Pi$  is the piezoresistance tensor (SI units: Pa<sup>-1</sup>Ωm), a material property. Note that the definition of  $\Pi$  in COMSOL Multiphysics includes the resistivity in each element of the tensor, rather than having a scalar multiple outside of  $\Pi$  (which is possible only for materials with isotropic conductivity).  $\Pi$  is in this case a rank-4 tensor; however, it can be represented as a matrix if the resistivity and stress are converted to vectors within a reduced subscript notation. Within the Voigt notation used by COMSOL Multiphysics for this purpose, Equation 2 becomes:

$$\begin{bmatrix} \Delta\rho_{xx} \\ \Delta\rho_{yy} \\ \Delta\rho_{zz} \\ \Delta\rho_{yz} \\ \Delta\rho_{xz} \\ \Delta\rho_{xy} \end{bmatrix} = \begin{bmatrix} \Pi_{11} & \Pi_{12} & \Pi_{13} & \Pi_{14} & \Pi_{15} & \Pi_{16} \\ \Pi_{21} & \Pi_{22} & \Pi_{23} & \Pi_{24} & \Pi_{25} & \Pi_{26} \\ \Pi_{31} & \Pi_{32} & \Pi_{33} & \Pi_{34} & \Pi_{35} & \Pi_{36} \\ \Pi_{41} & \Pi_{42} & \Pi_{43} & \Pi_{44} & \Pi_{45} & \Pi_{46} \\ \Pi_{51} & \Pi_{52} & \Pi_{53} & \Pi_{54} & \Pi_{55} & \Pi_{56} \\ \Pi_{61} & \Pi_{62} & \Pi_{63} & \Pi_{64} & \Pi_{65} & \Pi_{66} \end{bmatrix} \cdot \begin{bmatrix} \sigma^{xx} \\ \sigma^{yy} \\ \sigma^{zz} \\ \sigma^{yz} \\ \sigma^{xz} \\ \sigma^{xy} \end{bmatrix} \quad (3)$$

The  $\Delta\rho$  vector computed from Equation 3 is assembled into matrix form in the following manner in Equation 1:

$$\begin{bmatrix} E_x \\ E_y \\ E_z \end{bmatrix} = \begin{bmatrix} \rho_{xx} & \rho_{xy} & \rho_{xz} \\ \rho_{xy} & \rho_{yy} & \rho_{yz} \\ \rho_{xz} & \rho_{yz} & \rho_{zz} \end{bmatrix} \cdot \begin{bmatrix} J_x \\ J_y \\ J_z \end{bmatrix} + \begin{bmatrix} \Delta\rho_{xx} & \Delta\rho_{xy} & \Delta\rho_{xz} \\ \Delta\rho_{xy} & \Delta\rho_{yy} & \Delta\rho_{yz} \\ \Delta\rho_{xz} & \Delta\rho_{yz} & \Delta\rho_{zz} \end{bmatrix} \cdot \begin{bmatrix} J_x \\ J_y \\ J_z \end{bmatrix} \quad (4)$$

Silicon has cubic symmetry, and as a result the  $\Pi$  matrix can be described in terms of three independent constants in the following manner:

$$\Pi = \begin{bmatrix} \Pi_{11} & \Pi_{12} & \Pi_{12} & 0 & 0 & 0 \\ \Pi_{12} & \Pi_{22} & \Pi_{12} & 0 & 0 & 0 \\ \Pi_{12} & \Pi_{12} & \Pi_{33} & 0 & 0 & 0 \\ 0 & 0 & 0 & \Pi_{44} & 0 & 0 \\ 0 & 0 & 0 & 0 & \Pi_{44} & 0 \\ 0 & 0 & 0 & 0 & 0 & \Pi_{44} \end{bmatrix}$$

For p-type silicon the  $\Pi_{44}$  constant is two orders of magnitude larger than either the  $\Pi_{11}$  or the  $\Pi_{12}$  coefficients. The  $\Pi_{66}$  element (which is equal in magnitude to the  $\Pi_{44}$  element) couples the  $\sigma_{xy}$  shear stress, with the  $\Delta\rho_{xy}$  off-diagonal term in the change in resistivity matrix. In turn,  $\Delta\rho_{xy}$  couples a current in the  $x$ -direction to an induced electric field in the  $y$ -direction (and vice versa). This is the principle of the Xducer™ transducer. An applied voltage (typically 3 V; see Ref. 2) across the [100] orientated arm of the X produces a current (typically 6 mA; see Ref. 2) down this arm. Shear stresses are present in the Xducer™ as a result of the pressure induced deformation of the diaphragm in which it is implanted. Through the piezoresistance effect, these shear stresses cause an electric field or potential gradient transverse to the direction of current flow, in the [010] arm of the X.

Across the width of the transducer, the potential gradient sums up to produce an induced voltage difference between the [010] arms of the X. According to the device data sheet, under normal operating conditions a 60 mV potential difference is generated from a 100 kPa applied pressure with a 3 V applied bias (Ref. 2).

The situation is complicated somewhat by the detailed current distribution within the device, since the voltage sensing elements increase the width of the current carrying silicon wire locally, leading to a “short circuit” effect (Ref. 3) or a spreading out of the current into the sense arms of the X.

The Piezoresistivity interfaces available in the MEMS Module solve Equation 3 and an inverse form of Equation 4, together with the equations of structural mechanics. In this model the *Piezoresistivity, Boundary Currents* interface is used to model the structural equations on the domain level and to solve the electrical equations on a thin layer coincident with a boundary in the model geometry.

## *Results and Discussion*

---

Figure 2 shows the displacement of the diaphragm as a result of a 100 kPa pressure difference. At the center of the diaphragm the displacement is 1.2  $\mu\text{m}$ . A simple isotropic model for the deform displacement given in Ref. 1 predicts an order of magnitude value of 4  $\mu\text{m}$  (assuming a Young’s modulus of 170 GPa and a Poisson’s ratio of 0.06). The agreement is reasonable considering the limitations of the analytic model, which is derived by a crude variational guess. A more accurate value for the shear stress in local coordinates at the midpoint of the diaphragm edge is given in Ref. 1 as:

$$\sigma^{l,12} = 0.141 \left( \frac{L}{H} \right)^2 P$$

where  $P$  is the applied pressure,  $L$  is the length of the diaphragm edge, and  $H$  is the diaphragm thickness. This equation predicts the magnitude of the local shear stress to be 35 MPa, in good agreement with the minimum value shown in Figure 3, which is also 35 MPa. Theoretically the shear stress should be maximal at the midpoint of the edge of the diaphragm. Figure 4 shows the shear stress along the edge in the model. This shows a maximum magnitude at the center of each of the two edges along which the plot is made, but the value of this maximum is less than the maximum stress in the model, in part due to the boundary conditions employed on the three dimensional diaphragm. The model:

piezoresistive\_pressure\_sensor\_shell.mph shows better agreement with the theoretical maximum shear stress along this edge.

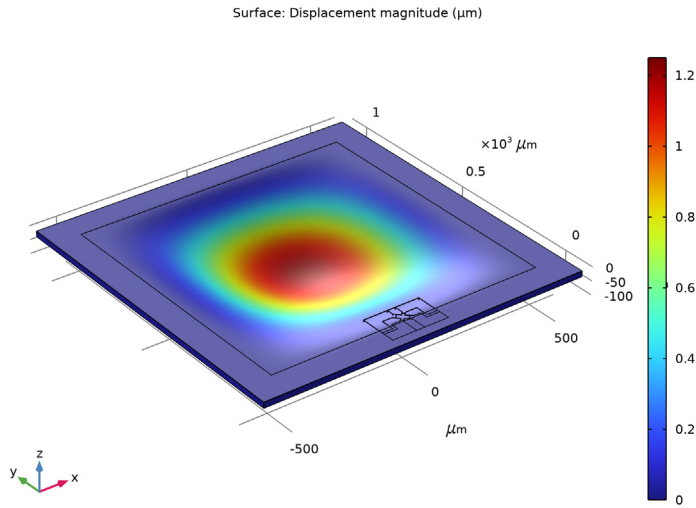

Figure 2: Diaphragm displacement as a result of a 100 kPa applied pressure.

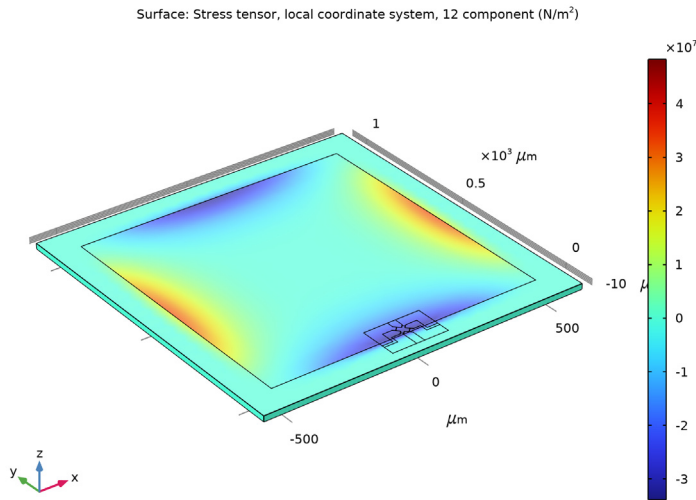
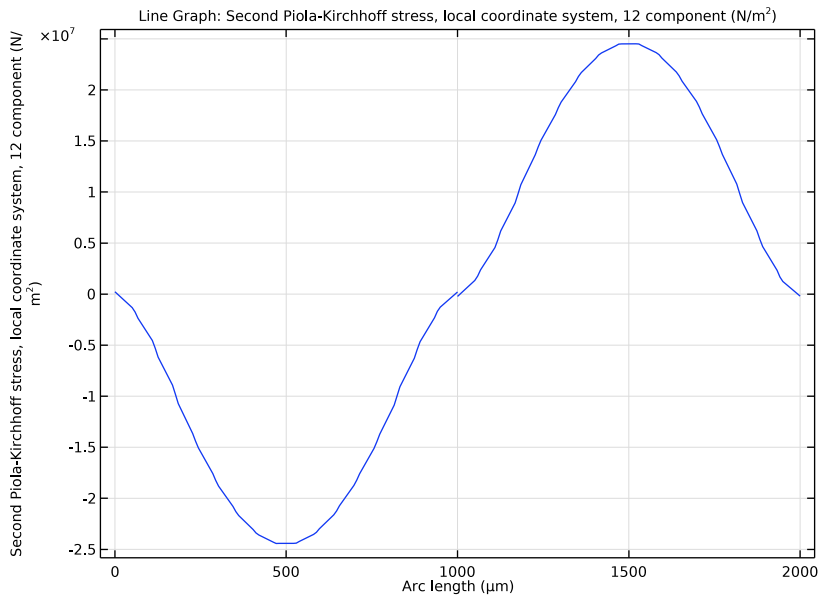

Figure 3: Shear stress, shown in the local coordinate system of the piezoresistor (rotated  $45^\circ$  about the z-axis of the global system). The shear stress is has its highest magnitude close to the piezoresistor with a value of approximately -35 MPa.



*Figure 4: Plot of the local shear stress along two edges of the diaphragm.*

The output of the model during normal operation shows good agreement with the manufacturer’s data sheet, given that the device dimensions and doping levels have been guessed. With an applied bias of 3 V a typical operating current of 5.9 mA is obtained (compare the current quoted in [Ref. 2](#) of 6 mA). The model produces an output voltage of 52 mV, similar to the actual device output of 60 mV quoted in [Ref. 2](#). The detailed current and voltage distribution within the Xducer™ is shown in [Figure 5](#). There is clear evidence of the current flow “spreading out” into the sense electrodes (which are narrower), a phenomena described in [Ref. 3](#) as the “short circuit” effect. The asymmetry in the potential, which is induced by the piezoresistive effect, is also apparent in the figure.

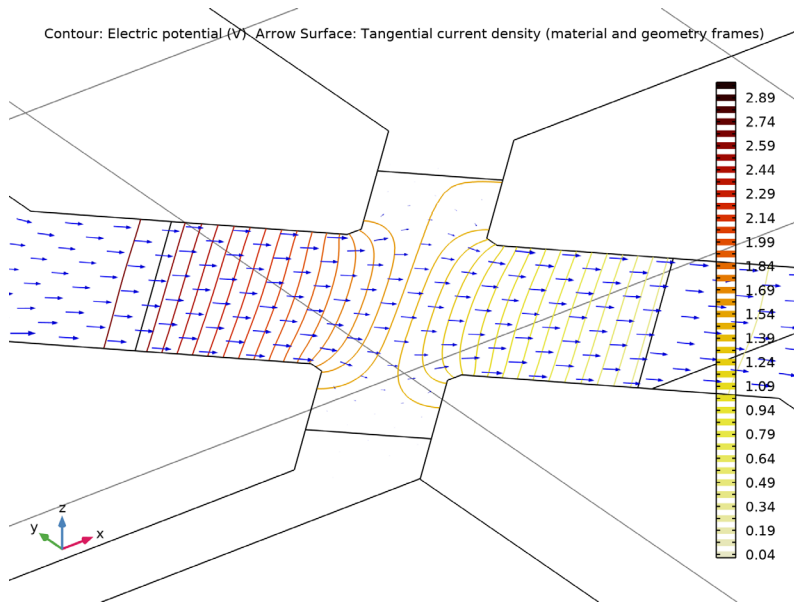

Figure 5: Arrows: Current density, Contours: Electric Potential, for a device driven by a 3 V bias with an applied pressure of 100 kPa.

## References

1. S.D. Senturia, "A Piezoresistive Pressure Sensor," *Microsystem Design*, chapter 18, Springer, 2000.
2. Motorola Semiconductor MPX100 series technical data, document: MPX100/D, 1998 (available from Freescale Semiconductor Inc at <http://www.freescale.com>).
3. M. Bao, *Analysis and Design Principles of MEMS Devices*, Elsevier B. V., 2005.

---

**Application Library path:** MEMS\_Module/Sensors/  
piezoresistive\_pressure\_sensor

---

## Modeling Instructions



From the **File** menu, choose **New**.



## NEW

In the **New** window, click  **Model Wizard**.

## MODEL WIZARD

- 1 In the **Model Wizard** window, click  **3D**.
- 2 In the **Select Physics** tree, select **Structural Mechanics>Electromagnetics-Structure Interaction>Piezoresistivity>Piezoresistivity, Boundary Currents**.
- 3 Click **Add**.
- 4 Click  **Study**.
- 5 In the **Select Study** tree, select **General Studies>Stationary**.
- 6 Click  **Done**.

## GEOMETRY I

- 1 In the **Model Builder** window, under **Component 1 (comp1)** click **Geometry 1**.
- 2 In the **Settings** window for **Geometry**, locate the **Units** section.
- 3 From the **Length unit** list, choose **µm**.  
  
For convenience, the device geometry is inserted from an existing file. You can read the instructions for creating the geometry in the [Appendix — Geometry Modeling Instructions](#).
- 4 In the **Geometry** toolbar, click **Insert Sequence** and choose **Insert Sequence**.
- 5 Browse to the model's Application Libraries folder and double-click the file `piezoresistive_pressure_sensor_geom_sequence.mph`.
- 6 In the **Geometry** toolbar, click  **Build All**.

## DEFINITIONS

### *Piezoresistor*

- 1 In the **Definitions** toolbar, click  **Explicit**.
- 2 In the **Settings** window for **Explicit**, type **Piezoresistor** in the **Label** text field.
- 3 Locate the **Input Entities** section. From the **Geometric entity level** list, choose **Boundary**.
- 4 Select **Boundary 46** only.

### *Connections*

- 1 In the **Definitions** toolbar, click  **Explicit**.
- 2 In the **Settings** window for **Explicit**, type **Connections** in the **Label** text field.
- 3 Locate the **Input Entities** section. From the **Geometric entity level** list, choose **Boundary**.

4 Select Boundaries 14, 22, 26, 39, 46, 73, 77, 81, and 104 only.

#### *Membrane (Lower Surface)*

- 1 In the **Definitions** toolbar, click  **Box**.
- 2 In the **Settings** window for **Box**, type Membrane (Lower Surface) in the **Label** text field.
- 3 Locate the **Geometric Entity Level** section. From the **Level** list, choose **Boundary**.
- 4 Locate the **Box Limits** section. In the **x minimum** text field, type -501.
- 5 In the **x maximum** text field, type 501.
- 6 In the **y minimum** text field, type -30.
- 7 In the **y maximum** text field, type 1000.
- 8 In the **z maximum** text field, type -1.
- 9 Locate the **Output Entities** section. From the **Include entity if** list, choose **Entity inside box**.

#### *Membrane (Upper Surface)*

- 1 Right-click **Membrane (Lower Surface)** and choose **Duplicate**.
- 2 In the **Settings** window for **Box**, type Membrane (Upper Surface) in the **Label** text field.
- 3 Locate the **Box Limits** section. In the **z minimum** text field, type -1.
- 4 In the **z maximum** text field, type inf.

#### *Lower Surface*

- 1 In the **Definitions** toolbar, click  **Box**.
- 2 In the **Settings** window for **Box**, type Lower Surface in the **Label** text field.
- 3 Locate the **Geometric Entity Level** section. From the **Level** list, choose **Boundary**.
- 4 Locate the **Box Limits** section. In the **z maximum** text field, type -1.
- 5 Locate the **Output Entities** section. From the **Include entity if** list, choose **Entity inside box**.

#### *Upper Surface*

- 1 Right-click **Lower Surface** and choose **Duplicate**.
- 2 In the **Settings** window for **Box**, type Upper Surface in the **Label** text field.
- 3 Locate the **Box Limits** section. In the **z minimum** text field, type -1.
- 4 In the **z maximum** text field, type inf.

### *Fixed*

- 1 In the **Definitions** toolbar, click  **Difference**.
- 2 In the **Settings** window for **Difference**, type Fixed in the **Label** text field.
- 3 Locate the **Geometric Entity Level** section. From the **Level** list, choose **Boundary**.
- 4 Locate the **Input Entities** section. Under **Selections to add**, click **+ Add**.
- 5 In the **Add** dialog box, select **Lower Surface** in the **Selections to add** list.
- 6 Click **OK**.
- 7 In the **Settings** window for **Difference**, locate the **Input Entities** section.
- 8 Under **Selections to subtract**, click **+ Add**.
- 9 In the **Add** dialog box, select **Membrane (Lower Surface)** in the **Selections to subtract** list.
- 10 Click **OK**.



### *Electric Currents*

- 1 In the **Definitions** toolbar, click  **Union**.
- 2 In the **Settings** window for **Union**, type Electric Currents in the **Label** text field.
- 3 Locate the **Geometric Entity Level** section. From the **Level** list, choose **Boundary**.
- 4 Locate the **Input Entities** section. Under **Selections to add**, click **+ Add**.
- 5 In the **Add** dialog box, in the **Selections to add** list, choose **Piezoresistor** and **Connections**.
- 6 Click **OK**.

### *Rotated System 2 (sys2)*

- 1 In the **Definitions** toolbar, click  **Coordinate Systems** and choose **Rotated System**.
- 2 In the **Settings** window for **Rotated System**, locate the **Rotation** section.
- 3 Find the **Euler angles (Z-X-Z)** subsection. In the  $\alpha$  text field, type -45[deg].

### **ADD MATERIAL**

- 1 In the **Home** toolbar, click  **Add Material** to open the **Add Material** window.
- 2 Go to the **Add Material** window.
- 3 In the tree, select **Piezoresistivity>n-Silicon (single-crystal, lightly doped)**.
- 4 Right-click and choose **Add to Component 1 (comp1)**.
- 5 In the tree, select **Piezoresistivity>p-Silicon (single-crystal, lightly doped)**.
- 6 Right-click and choose **Add to Component 1 (comp1)**.
- 7 In the **Home** toolbar, click  **Add Material** to close the **Add Material** window.

## MATERIALS

*p-Silicon (single-crystal, lightly doped) (mat2)*

- 1 In the **Settings** window for **Material**, locate the **Geometric Entity Selection** section.
- 2 From the **Geometric entity level** list, choose **Boundary**.
- 3 From the **Selection** list, choose **Electric Currents**.

## SOLID MECHANICS (SOLID)

*Linear Elastic Material I*

- 1 In the **Model Builder** window, under **Component 1 (comp1)>Solid Mechanics (solid)** click **Linear Elastic Material I**.
- 2 In the **Settings** window for **Linear Elastic Material**, locate the **Coordinate System Selection** section.
- 3 From the **Coordinate system** list, choose **Rotated System 2 (sys2)**.
- 4 Locate the **Linear Elastic Material** section. From the **Solid model** list, choose **Anisotropic**.
- 5 From the **Material data ordering** list, choose **Voigt (11, 22, 33, 23, 13, 12)**.

*Fixed Constraint I*

- 1 In the **Physics** toolbar, click  **Boundaries** and choose **Fixed Constraint**.
- 2 In the **Settings** window for **Fixed Constraint**, locate the **Boundary Selection** section.
- 3 From the **Selection** list, choose **Fixed**.

*Boundary Load I*

- 1 In the **Physics** toolbar, click  **Boundaries** and choose **Boundary Load**.
- 2 In the **Settings** window for **Boundary Load**, locate the **Boundary Selection** section.
- 3 From the **Selection** list, choose **Membrane (Upper Surface)**.
- 4 Locate the **Force** section. From the **Load type** list, choose **Pressure**.
- 5 In the  $p$  text field, type 100[kPa].

## ELECTRIC CURRENTS, SINGLE LAYER SHELL (ECS)

- 1 In the **Model Builder** window, under **Component 1 (comp1)** click **Electric Currents, Single Layer Shell (ecs)**.
- 2 In the **Settings** window for **Electric Currents, Single Layer Shell**, locate the **Boundary Selection** section.
- 3 From the **Selection** list, choose **Electric Currents**.
- 4 Locate the **Shell Thickness** section. In the  $d_s$  text field, type 400[nm].

- 5 Click the  **Show More Options** button in the **Model Builder** toolbar.
- 6 In the **Show More Options** dialog box, in the tree, select the check box for the node **Physics>Advanced Physics Options**.
- 7 Click **OK**.

#### *Current Conservation 1*

- 1 In the **Model Builder** window, under **Component 1 (comp1)>Electric Currents, Single Layer Shell (ecs)** click **Current Conservation 1**.
- 2 In the **Settings** window for **Current Conservation**, locate the **Model Inputs** section.
- 3 In the  $n_d$  text field, type  $1.45e20[1/cm^3]$ .
- 4 Locate the **Coordinate System Selection** section. From the **Coordinate system** list, choose **Rotated System 2 (sys2)**.

#### *Piezoresistive Material 1*

- 1 In the **Model Builder** window, click **Piezoresistive Material 1**.
- 2 In the **Settings** window for **Piezoresistive Material**, locate the **Boundary Selection** section.
- 3 From the **Selection** list, choose **Piezoresistor**.
- 4 Locate the **Model Input** section. In the  $n_d$  text field, type  $1.32e19[1/cm^3]$ .
- 5 Locate the **Coordinate System Selection** section. From the **Coordinate system** list, choose **Rotated System 2 (sys2)**.

#### *Ground 1*

- 1 In the **Physics** toolbar, click  **Edges** and choose **Ground**.
- 2 Select Edge 195 only.

#### *Terminal 1*

- 1 In the **Physics** toolbar, click  **Edges** and choose **Terminal**.
- 2 Select Edges 30 and 35 only.
- 3 In the **Settings** window for **Terminal**, locate the **Terminal** section.
- 4 From the **Terminal type** list, choose **Voltage**.
- 5 In the  $V_0$  text field, type 3.

#### *Terminal 2*

- 1 In the **Physics** toolbar, click  **Edges** and choose **Terminal**.
- 2 Select Edge 20 only.

#### *Terminal 3*

- 1 In the **Physics** toolbar, click  **Edges** and choose **Terminal**.

2 Select Edges 201 and 205 only.

### **MESH 1**

1 In the **Model Builder** window, under **Component 1 (comp1)** click **Mesh 1**.

2 In the **Settings** window for **Mesh**, locate the **Sequence Type** section.

3 From the list, choose **User-controlled mesh**.

### *Size*

1 In the **Model Builder** window, under **Component 1 (comp1)>Mesh 1** click **Size**.

2 In the **Settings** window for **Size**, locate the **Element Size** section.

3 Click the **Custom** button.

4 Locate the **Element Size Parameters** section. In the **Maximum element size** text field, type 60.

5 In the **Minimum element size** text field, type 0.5.

### *Size 1*

1 In the **Model Builder** window, right-click **Mesh 1** and choose **Size**.

2 In the **Settings** window for **Size**, locate the **Geometric Entity Selection** section.

3 From the **Geometric entity level** list, choose **Boundary**.

4 From the **Selection** list, choose **Piezoresistor**.

5 Locate the **Element Size** section. Click the **Custom** button.

6 Locate the **Element Size Parameters** section. Select the **Maximum element size** check box.

7 In the associated text field, type 2.

8 Select the **Minimum element size** check box.

9 In the associated text field, type 0.1.

### *Size 2*

1 Right-click **Size 1** and choose **Duplicate**.

2 In the **Settings** window for **Size**, locate the **Geometric Entity Selection** section.

3 From the **Selection** list, choose **Connections**.

4 Locate the **Element Size Parameters** section. In the **Maximum element size** text field, type 6.

### *Size 3*

1 Right-click **Size 2** and choose **Duplicate**.

2 In the **Settings** window for **Size**, locate the **Geometric Entity Selection** section.

- 3 From the **Geometric entity level** list, choose **Edge**.
- 4 Select Edges 74, 79, 104, 108, 111, 114, 117, 120, 123, 142, 143, and 146 only.
- 5 Locate the **Element Size Parameters** section. In the **Maximum element size** text field, type 0.4.



#### *Free Tetrahedral I*

In the **Model Builder** window, right-click **Free Tetrahedral I** and choose **Disable**.

#### *Free Triangular I*

- 1 In the **Mesh** toolbar, click  **Boundary** and choose **Free Triangular**.
- 2 In the **Settings** window for **Free Triangular**, locate the **Boundary Selection** section.
- 3 From the **Selection** list, choose **Upper Surface**.

#### *Swept I*

- 1 In the **Mesh** toolbar, click  **Swept**.
- 2 Click  **Build Mesh**.
- 3 In the **Home** toolbar, click  **Compute**.

## **RESULTS**

#### *Stress (solid)*

The default plots show the von Mises stress and the electric potential. Now create a plot of the displacement to compare with [Figure 2](#).

#### *Displacement*

- 1 In the **Home** toolbar, click  **Add Plot Group** and choose **3D Plot Group**.
- 2 In the **Settings** window for **3D Plot Group**, type Displacement in the **Label** text field.

#### *Surface I*

- 1 Right-click **Displacement** and choose **Surface**.
- 2 In the **Settings** window for **Surface**, click **Replace Expression** in the upper-right corner of the **Expression** section. From the menu, choose **Component 1 (comp1)>Solid Mechanics>Displacement>solid.disp - Displacement magnitude - m**.

#### *Deformation I*

- 1 Right-click **Surface I** and choose **Deformation**.
- 2 In the **Displacement** toolbar, click  **Plot**.

Now create a plot of the shear stress in the local coordinate system of the piezoresistor, to compare with [Figure 3](#).

### *In-Plane Shear Stress (Local Coordinates)*

- 1 In the **Home** toolbar, click  **Add Plot Group** and choose **3D Plot Group**.
- 2 In the **Settings** window for **3D Plot Group**, type In-Plane Shear Stress (Local Coordinates) in the **Label** text field.

### *Surface 1*

- 1 Right-click **In-Plane Shear Stress (Local Coordinates)** and choose **Surface**.
- 2 In the **Settings** window for **Surface**, click **Replace Expression** in the upper-right corner of the **Expression** section. From the menu, choose **Component 1 (comp1)>Solid Mechanics>Stress>Stress tensor, local coordinate system - N/m<sup>2</sup>>solid.sl12 - Stress tensor, local coordinate system, 12 component**.
- 3 In the **In-Plane Shear Stress (Local Coordinates)** toolbar, click  **Plot**.  
Create a line plot of the shear stress in the local coordinate system of the piezoresistor, to compare with [Figure 4](#).

### *In-Plane Shear Stress (Local Coordinate System)*

- 1 In the **Home** toolbar, click  **Add Plot Group** and choose **1D Plot Group**.
- 2 In the **Settings** window for **1D Plot Group**, type In-Plane Shear Stress (Local Coordinate System) in the **Label** text field.

### *Line Graph 1*

- 1 Right-click **In-Plane Shear Stress (Local Coordinate System)** and choose **Line Graph**.
- 2 Select Edges 16 and 213 only.
- 3 In the **Settings** window for **Line Graph**, click **Replace Expression** in the upper-right corner of the **y-Axis Data** section. From the menu, choose **Component 1 (comp1)>Solid Mechanics>Stress>Second Piola-Kirchhoff stress, local coordinate system - N/m<sup>2</sup>>solid.sl12 - Second Piola-Kirchhoff stress, local coordinate system, 12 component**.
- 4 In the **In-Plane Shear Stress (Local Coordinate System)** toolbar, click  **Plot**.  
Now create a plot of the detailed current and voltage distribution, to compare with [Figure 5](#).

### *Study 1/Solution 1 (2) (sol1)*

- 1 In the **Model Builder** window, expand the **Results>Datasets** node.
- 2 Right-click **Results>Datasets>Study 1/Solution 1 (sol1)** and choose **Duplicate**.

### *Selection*

- 1 In the **Results** toolbar, click  **Attributes** and choose **Selection**.
- 2 In the **Settings** window for **Selection**, locate the **Geometric Entity Selection** section.



- 3 From the **Geometric entity level** list, choose **Boundary**.
- 4 From the **Selection** list, choose **Piezoresistor**.
- 5 Click  **Zoom to Selection**.
- 6 From the **Selection** list, choose **Electric Currents**.

#### *Current and Voltage*

- 1 In the **Results** toolbar, click  **3D Plot Group**.
- 2 In the **Settings** window for **3D Plot Group**, type **Current** and **Voltage** in the **Label** text field.
- 3 Locate the **Data** section. From the **Dataset** list, choose **Study 1/Solution 1 (2) (sol1)**.

#### *Contour 1*

- 1 Right-click **Current and Voltage** and choose **Contour**.
- 2 In the **Settings** window for **Contour**, locate the **Expression** section.
- 3 In the **Expression** text field, type **V**.
- 4 Locate the **Levels** section. In the **Total levels** text field, type **40**.
- 5 Locate the **Coloring and Style** section. From the **Color table** list, choose **ThermalDark**.
- 6 From the **Color table transformation** list, choose **Reverse**.

#### *Arrow Surface 1*

- 1 In the **Model Builder** window, right-click **Current and Voltage** and choose **Arrow Surface**.
- 2 In the **Settings** window for **Arrow Surface**, click **Replace Expression** in the upper-right corner of the **Expression** section. From the menu, choose **Component 1 (comp1) > Electric Currents, Single Layer Shell > Currents and charge > ecs.tjX,...,ecs.tjZ - Tangential current density (material and geometry frames)**.
- 3 Locate the **Coloring and Style** section. Select the **Scale factor** check box.
- 4 In the associated text field, type **2e-9**.
- 5 Locate the **Arrow Positioning** section. In the **Number of arrows** text field, type **3000**.
- 6 Locate the **Coloring and Style** section. From the **Color** list, choose **Blue**.
- 7 In the **Current and Voltage** toolbar, click  **Plot**.

Finally evaluate the current drawn by the device and the output voltage.

#### *Global Evaluation 1*

- 1 In the **Results** toolbar, click  **Global Evaluation**.

- 2 In the **Settings** window for **Global Evaluation**, click **Replace Expression** in the upper-right corner of the **Expressions** section. From the menu, choose **Component 1 (comp1)>Electric Currents, Single Layer Shell>Terminals>ecs.I0\_1 - Terminal current - A**.
- 3 Click **Add Expression** in the upper-right corner of the **Expressions** section. From the menu, choose **Component 1 (comp1)>Electric Currents, Single Layer Shell>Terminals>ecs.V0\_2 - Terminal voltage - V**.
- 4 Locate the **Expressions** section. In the table, enter the following settings:

Expression	Unit	Description
ecs.I0_1	mA	Terminal current
ecs.V0_2-ecs.V0_3	mV	Device Output

- 5 Click  **Evaluate**.

## *Appendix — Geometry Modeling Instructions*

---

From the **File** menu, choose **New**.

### **NEW**

In the **New** window, click  **Blank Model**.

### **ADD COMPONENT**

In the **Home** toolbar, click  **Add Component** and choose **3D**.

### **GEOMETRY I**

- 1 In the **Settings** window for **Geometry**, locate the **Units** section.

- 2 From the **Length unit** list, choose **µm**.

*Work Plane 1 (wp1)*

In the **Geometry** toolbar, click  **Work Plane**.

*Work Plane 1 (wp1)>Plane Geometry*

In the **Model Builder** window, click **Plane Geometry**.

*Work Plane 1 (wp1)>Square 1 (sq1)*

- 1 In the **Work Plane** toolbar, click  **Square**.

- 2 In the **Settings** window for **Square**, locate the **Size** section.

- 3 In the **Side length** text field, type 1200.

- 4 Locate the **Position** section. From the **Base** list, choose **Center**.

5 In the **yw** text field, type 478.

6 Click to expand the **Layers** section. In the table, enter the following settings:

Layer name	Thickness ( $\mu\text{m}$ )
Layer 1	100

7 Select the **Layers to the left** check box.

8 Select the **Layers to the right** check box.

9 Select the **Layers on top** check box.

*Work Plane 1 (wp1)>Square 2 (sq2)*

1 In the **Work Plane** toolbar, click  **Square**.

2 In the **Settings** window for **Square**, locate the **Size** section.

3 In the **Side length** text field, type 22.6.

4 Locate the **Position** section. From the **Base** list, choose **Center**.

*Work Plane 1 (wp1)>Rectangle 1 (r1)*

1 In the **Work Plane** toolbar, click  **Rectangle**.

2 In the **Settings** window for **Rectangle**, locate the **Size and Shape** section.

3 In the **Width** text field, type 52.5.

4 In the **Height** text field, type 10.

5 Locate the **Position** section. From the **Base** list, choose **Center**.

6 Locate the **Rotation Angle** section. In the **Rotation** text field, type 45.

7 Click to expand the **Layers** section. In the table, enter the following settings:

Layer name	Thickness ( $\mu\text{m}$ )
Layer 1	6.25

8 Select the **Layers to the right** check box.

9 Select the **Layers to the left** check box.

10 Clear the **Layers on bottom** check box.

*Work Plane 1 (wp1)>Rectangle 2 (r2)*

1 Right-click **Component 1 (comp1)>Geometry 1>Work Plane 1 (wp1)>Plane Geometry>Rectangle 1 (r1)** and choose **Duplicate**.

2 In the **Settings** window for **Rectangle**, locate the **Size and Shape** section.

3 In the **Width** text field, type 62.5.

- 4 In the **Height** text field, type 20.
- 5 Locate the **Rotation Angle** section. In the **Rotation** text field, type -45.
- 6 Locate the **Layers** section. In the table, enter the following settings:

Layer name	Thickness ( $\mu\text{m}$ )
Layer 1	11.25

*Work Plane 1 (wp1)>Rectangle 3 (r3)*

- 1 In the **Work Plane** toolbar, click  **Rectangle**.
- 2 In the **Settings** window for **Rectangle**, locate the **Size and Shape** section.
- 3 In the **Width** text field, type 210.
- 4 In the **Height** text field, type 140.
- 5 Locate the **Position** section. From the **Base** list, choose **Center**.
- 6 In the **yw** text field, type -15.

*Work Plane 1 (wp1)>Rectangle 4 (r4)*

- 1 In the **Work Plane** toolbar, click  **Rectangle**.
- 2 In the **Settings** window for **Rectangle**, locate the **Size and Shape** section.
- 3 In the **Width** text field, type 40.
- 4 In the **Height** text field, type 90.
- 5 Locate the **Position** section. In the **xw** text field, type -105.
- 6 In the **yw** text field, type -35.

*Work Plane 1 (wp1)>Rectangle 5 (r5)*

- 1 In the **Work Plane** toolbar, click  **Rectangle**.
- 2 In the **Settings** window for **Rectangle**, locate the **Size and Shape** section.
- 3 In the **Width** text field, type 50.
- 4 In the **Height** text field, type 40.
- 5 Locate the **Position** section. In the **xw** text field, type -65.
- 6 In the **yw** text field, type 15.

*Work Plane 1 (wp1)>Rectangle 6 (r6)*

- 1 In the **Work Plane** toolbar, click  **Rectangle**.
- 2 In the **Settings** window for **Rectangle**, locate the **Size and Shape** section.
- 3 In the **Width** text field, type 90.
- 4 In the **Height** text field, type 40.

- 5 Locate the **Position** section. In the **xw** text field, type -105.
- 6 In the **yw** text field, type -85.

*Work Plane 1 (wp1)>Rectangle 7 (r7)*

- 1 In the **Work Plane** toolbar, click  **Rectangle**.
- 2 In the **Settings** window for **Rectangle**, locate the **Size and Shape** section.
- 3 In the **Width** text field, type 40.
- 4 In the **Height** text field, type 30.
- 5 Locate the **Position** section. In the **xw** text field, type -55.
- 6 In the **yw** text field, type -45.

*Work Plane 1 (wp1)>Mirror 1 (mir1)*

- 1 In the **Work Plane** toolbar, click  **Transforms** and choose **Mirror**.
- 2 Select the objects **r4**, **r5**, **r6**, and **r7** only.
- 3 In the **Settings** window for **Mirror**, locate the **Input** section.
- 4 Select the **Keep input objects** check box.

*Extrude 1 (ext1)*

- 1 In the **Model Builder** window, under **Component 1 (comp1)>Geometry 1** right-click **Work Plane 1 (wp1)** and choose **Extrude**.
- 2 In the **Settings** window for **Extrude**, locate the **Distances** section.
- 3 In the table, enter the following settings:

Distances (μm)
20

- 4 Select the **Reverse direction** check box.

*Work Plane 2 (wp2)*

- 1 In the **Geometry** toolbar, click  **Work Plane**.
- 2 In the **Settings** window for **Work Plane**, locate the **Plane Definition** section.
- 3 From the **Plane type** list, choose **Face parallel**.
- 4 On the object **ext1**, select Boundary 50 only.
- 5 In the tree, select **ext1**.

*Form Composite Domains 1 (cmd1)*

- 1 In the **Geometry** toolbar, click  **Virtual Operations** and choose **Form Composite Domains**.

- 2 On the object **fin**, select Domains 10, 12, 14–18, 36, 39, 44–47, and 50 only.

#### *Form Composite Domains 2 (cmd2)*

- 1 In the **Geometry** toolbar, click  **Virtual Operations** and choose **Form Composite Domains**.
- 2 On the object **cmd1**, select Domains 7, 12, 16, 18, 32, and 36–38 only.

#### *Form Composite Domains 3 (cmd3)*

- 1 In the **Geometry** toolbar, click  **Virtual Operations** and choose **Form Composite Domains**.
- 2 On the object **cmd2**, select Domains 13, 14, 18–27, and 30 only.

#### *Form Composite Domains 4 (cmd4)*

- 1 In the **Geometry** toolbar, click  **Virtual Operations** and choose **Form Composite Domains**.
- 2 On the object **cmd3**, select Domains 1–4, 6, and 23–25 only.

#### *Partition Faces 1 (parf1)*

- 1 In the **Geometry** toolbar, click  **Booleans and Partitions** and choose **Partition Faces**.
- 2 On the object **cmd4**, select Boundaries 23 and 109 only.
- 3 In the **Settings** window for **Partition Faces**, locate the **Partition Faces** section.
- 4 From the **Partition with** list, choose **Work plane**.

#### *Piezoresistor*

- 1 In the **Geometry** toolbar, click  **Selections** and choose **Explicit Selection**.
- 2 In the **Settings** window for **Explicit Selection**, type Piezoresistor in the **Label** text field.
- 3 Locate the **Entities to Select** section. From the **Geometric entity level** list, choose **Boundary**.
- 4 On the object **parf1**, select Boundary 46 only.

#### *Connections*

- 1 In the **Geometry** toolbar, click  **Selections** and choose **Explicit Selection**.
- 2 In the **Settings** window for **Explicit Selection**, type Connections in the **Label** text field.
- 3 Locate the **Entities to Select** section. From the **Geometric entity level** list, choose **Boundary**.
- 4 On the object **parf1**, select Boundaries 14, 26, 39, 73, 77, and 81 only.

#### *Membrane (Lower Surface)*

- 1 In the **Geometry** toolbar, click  **Selections** and choose **Box Selection**.

- 2 In the **Settings** window for **Box Selection**, type Membrane (Lower Surface) in the **Label** text field.
- 3 Locate the **Geometric Entity Level** section. From the **Level** list, choose **Boundary**.
- 4 Locate the **Box Limits** section. In the **x minimum** text field, type -501.
- 5 In the **x maximum** text field, type 501.
- 6 In the **y minimum** text field, type -30.
- 7 In the **y maximum** text field, type 1000.
- 8 In the **z maximum** text field, type -1.
- 9 Locate the **Output Entities** section. From the **Include entity if** list, choose **Entity inside box**.

#### *Membrane (Upper Surface)*

- 1 Right-click **Membrane (Lower Surface)** and choose **Duplicate**.
- 2 In the **Settings** window for **Box Selection**, type Membrane (Upper Surface) in the **Label** text field.
- 3 Locate the **Box Limits** section. In the **z minimum** text field, type -1.
- 4 In the **z maximum** text field, type inf.



#### *Lower Surface*

- 1 In the **Geometry** toolbar, click  **Selections** and choose **Explicit Selection**.
- 2 In the **Settings** window for **Explicit Selection**, type Lower Surface in the **Label** text field.
- 3 Locate the **Entities to Select** section. From the **Geometric entity level** list, choose **Boundary**.
- 4 Select the **Group by continuous tangent** check box.
- 5 On the object **parfl**, select Boundaries 3, 8, 13, 17, 21, 25, 32, 38, 45, 51, 56, 61, 72, 76, 80, 84, 97, and 103 only.



#### *Upper Surface*

- 1 In the **Geometry** toolbar, click  **Selections** and choose **Explicit Selection**.
- 2 In the **Settings** window for **Explicit Selection**, type Upper Surface in the **Label** text field.
- 3 Locate the **Entities to Select** section. From the **Geometric entity level** list, choose **Boundary**.
- 4 Select the **Group by continuous tangent** check box.
- 5 On the object **parfl**, select Boundaries 4, 9, 14, 18, 22, 26, 33, 39, 46, 52, 57, 62, 73, 77, 81, 85, 98, and 104 only.

### *Fixed*

- 1 In the **Geometry** toolbar, click  **Selections** and choose **Difference Selection**.
- 2 In the **Settings** window for **Difference Selection**, type **Fixed** in the **Label** text field.
- 3 Locate the **Geometric Entity Level** section. From the **Level** list, choose **Boundary**.
- 4 Locate the **Input Entities** section. Click  **Add**.
- 5 In the **Add** dialog box, select **Lower Surface** in the **Selections to add** list.
- 6 Click **OK**.
- 7 In the **Settings** window for **Difference Selection**, locate the **Input Entities** section.
- 8 Click  **Add**.
- 9 In the **Add** dialog box, select **Membrane (Lower Surface)** in the **Selections to subtract** list.
- 10 Click **OK**.

### *Electric currents*

- 1 In the **Geometry** toolbar, click  **Selections** and choose **Union Selection**.
- 2 In the **Settings** window for **Union Selection**, type **Electric currents** in the **Label** text field.
- 3 Locate the **Geometric Entity Level** section. From the **Level** list, choose **Boundary**.
- 4 Locate the **Input Entities** section. Click  **Add**.
- 5 In the **Add** dialog box, in the **Selections to add** list, choose **Piezoresistor** and **Connections**.
- 6 Click **OK**.