



# Slider Crank Mechanism with Joint Clearance

## *Introduction*

---

Joints between two components of a mechanical system are not always perfectly fitting. For the ease of assembly and to allow relative movement between the components, a small gap called clearance is provided between the joining components. The presence of clearance on joints can sometimes adversely affect the performance of the system by generating impact forces thus giving rise to noise and vibrations.

This model compares the performance of a slider crank mechanism with and without a joint clearance. All components of the mechanism are assumed rigid. Hinge Joint node is used when there is no clearance on a joint whereas Clearance Joint node is used to include clearance on a joint. A transient analysis is performed to analyze the effect of joint clearance on slider velocity, slider acceleration, and crank moment. In addition to this, the dynamics of journal within the bearing and the reaction force in the clearance joint are also analyzed.

## *Model Definition*

---

As shown in [Figure 1](#), the model geometry consists of four rigid components: support, crank, connecting rod, and slider.

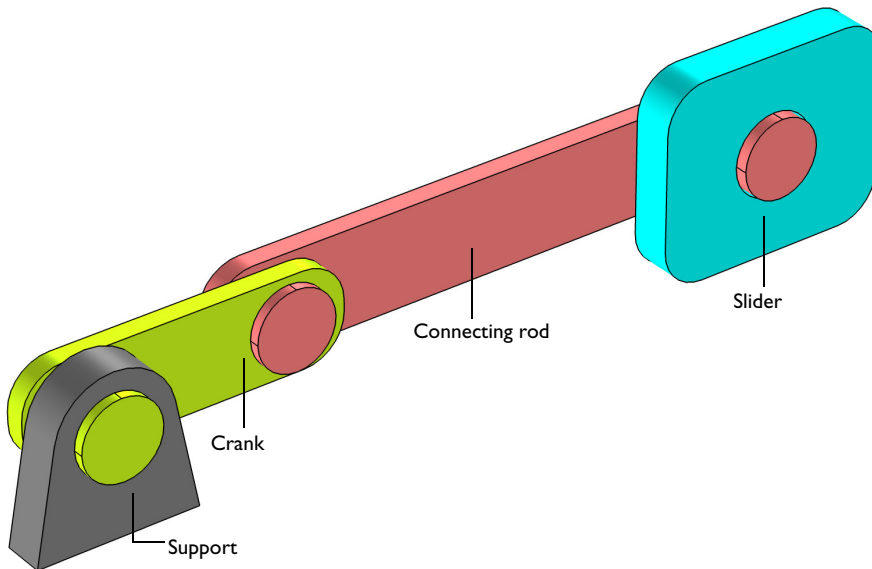

*Figure 1: Model geometry of a slider crank mechanism.*

One end of the crank is connected to the fixed support and other end to the connecting rod. Connecting rod, in turn, is connected to the center of the slider, which can slide freely along  $x$ -direction.

The connection between the support and crank is modeled as a hinge joint with one rotational degree of freedom about  $y$ -axis. A similar hinge joint is used to model the connection between crank and connecting rod also. To model the connection between connecting rod journal and slider, two different cases are considered:

- In the first case, a perfect hinge joint without any clearance is assumed between journal and the slider.
- In the second case, a clearance of 0.5 mm is provided between journal and the slider. A clearance joint is used to model this connection, which allows the connected members to move within the provided clearance distance.

The mechanism is driven by the crank which rotates with an angular velocity of 5000 rpm. A time dependent study is performed for 0.025 s to analyze the effect of joint clearance on slider velocity, slider acceleration, and crank moment.

### *Results and Discussion*

---

Figure 2 shows the displacement of components in the slider crank mechanism for hinge joint and clearance joint cases. To visualize the motion of connecting rod with respect to the slider, the relative displacement of connecting rod is plotted in Figure 3. For hinge joint case, the relative motion is purely rotational without any translation, however for clearance joint case, connecting rod journal exhibits both translational and rotational motion within the slider hole. This trajectory of the journal within the slider hole is plotted in Figure 7.

The time variation of slider velocity is plotted in Figure 4. It is observed that the velocity profile in hinge joint case is smoother compared to the clearance joint case. Unlike the continuous contact in hinge joint, the translation and the consequent impact of journal with the slider generate a step like velocity profile in clearance joint case. As shown in Figure 5 and Figure 6, the impact between journal and slider also causes sudden variations in slider acceleration and reaction moment in the crank.

Figure 8 shows the variation in clearance joint force as a function of time. The zero value of force at times denotes the intermittent contact within the clearance joint. The variation of gap distance with crank rotation is shown in Figure 9. When gap distance is negative (inside magenta circle), journal and slider are in contact and penalty force acts on the bodies to maintain the relative movement of journal within the specified clearance.

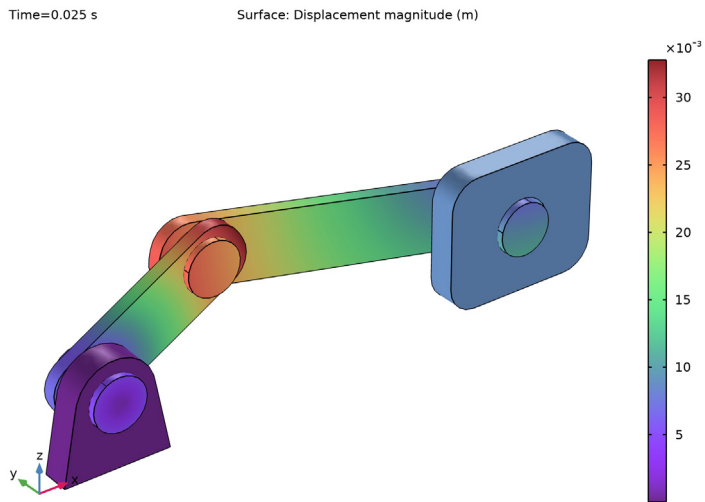
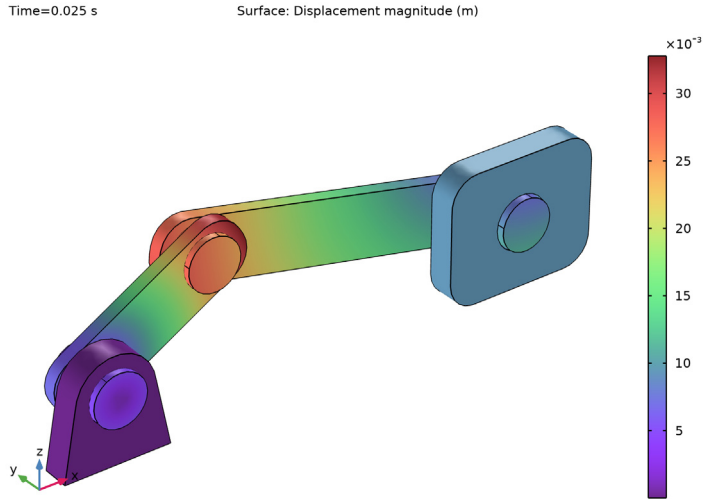

*Figure 2: Displacement of slider crank mechanism for hinge joint and clearance joint cases respectively at  $t = 0.025$  s.*

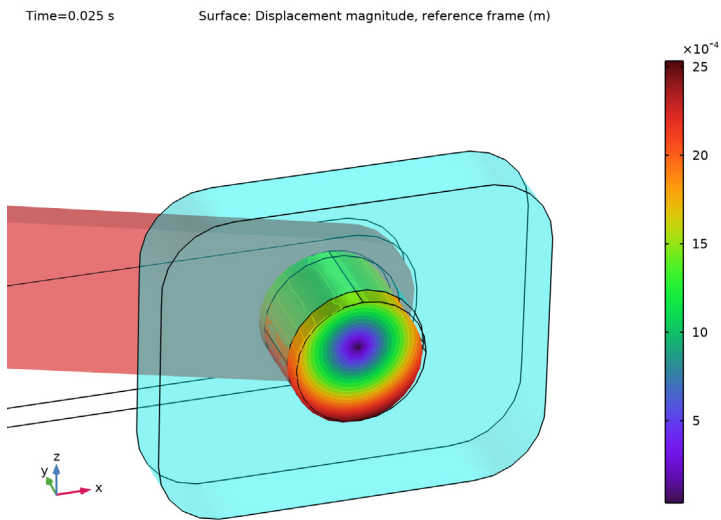
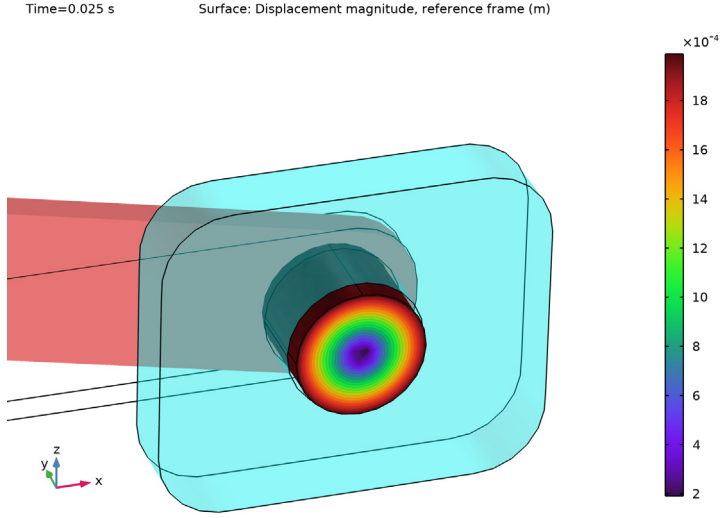

*Figure 3: Relative displacement of connecting rod journal with respect to the slider for hinge joint and clearance joint cases respectively at  $t = 0.025$  s.*

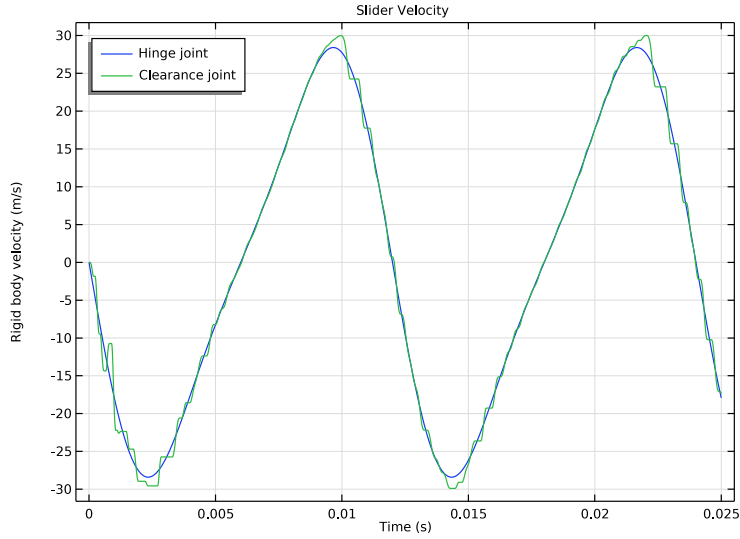

Figure 4: Variation of slider velocity, as a function of time.

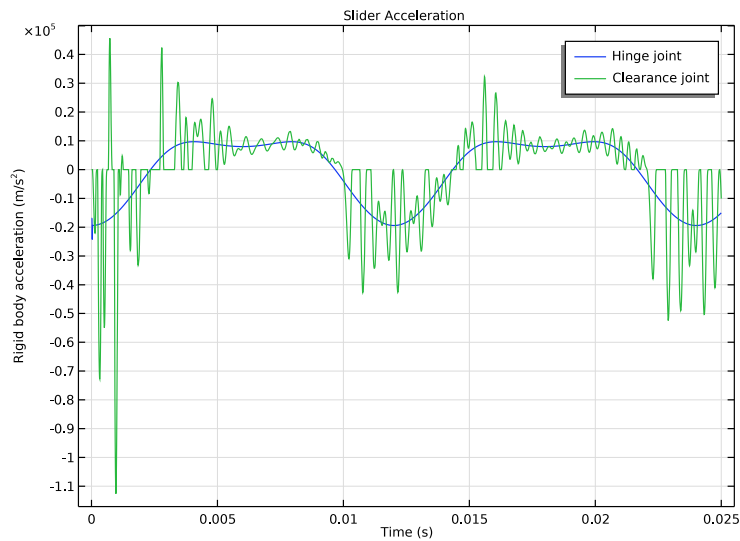

Figure 5: Variation of slider acceleration, as a function of time.

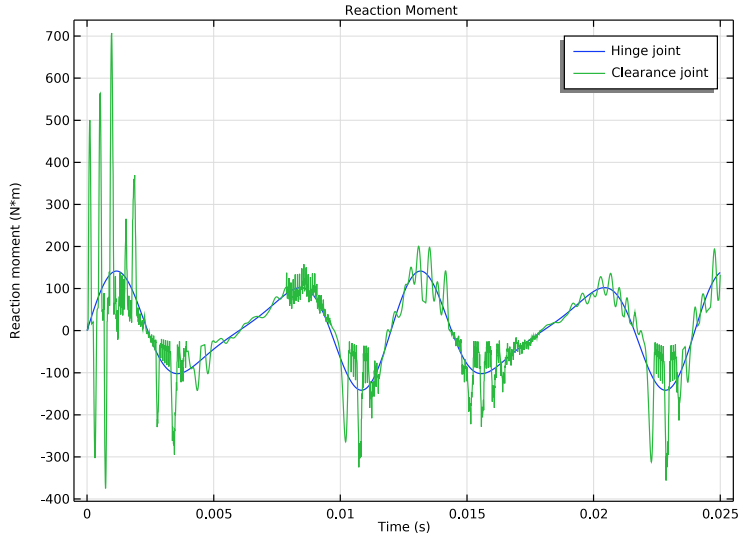

Figure 6: Variation of crank reaction moment, as a function of time.

Time=0.025 s                      Journal Trajectory: Clearance Joint

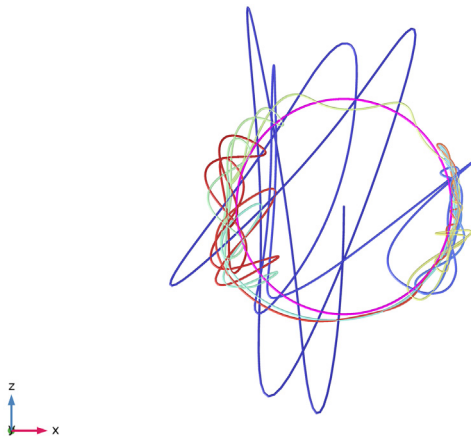

Figure 7: Journal trajectory within the slider hole for clearance joint case. Here blue color denotes the initial position and red color denotes the final position.

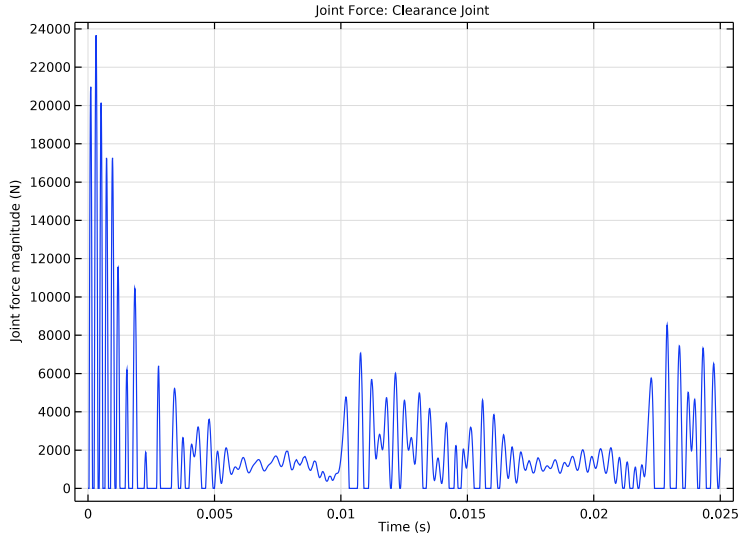

Figure 8: Variation of clearance joint force, as a function of time.

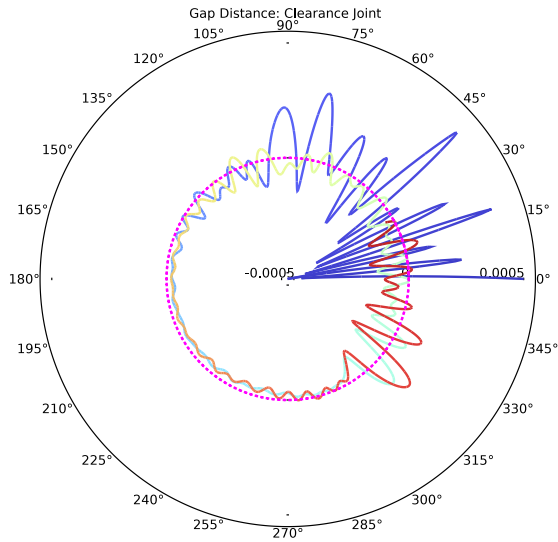

Figure 9: Variation of gap distance, as a function of crank rotation. Here blue color denotes the initial position, red color denotes the final position, and magenta dotted circle corresponds to the zero gap distance.



## Notes About the COMSOL Implementation

---

- In this model, linkages are modeled as rigid elements using the **Rigid Domain** nodes which can be created automatically using the **Create Rigid Domains** button in the **Automated Model Setup** section at the physics interface.
- **Joint** nodes between two respective components can also be created automatically using the **Create Joints** button in the **Automated Model Setup** section at the physics interface. The automatic joint creation requires the geometry to be in assembly mode and **Identity Boundary Pair** nodes to be available in the **Definitions**. In case geometry doesn't create an identity pair automatically because of a geometric clearance between the two sets of boundaries, then the identity pair can be created manually in order to create a joint between those two components.

## Reference

---

P. Flores and J. Ambrosio, "Revolute Joints with Clearance in Multibody Systems", *Computers and Structures*, vol. 82, pp. 1359–1369, 2004.

---

**Application Library path:** Multibody\_Dynamics\_Module/Tutorials/  
slider\_crank\_mechanism\_with\_clearance

---

## Modeling Instructions



---

From the **File** menu, choose **New**.

### NEW

In the **New** window, click  **Model Wizard**.

### MODEL WIZARD

- 1 In the **Model Wizard** window, click  **3D**.
- 2 In the **Select Physics** tree, select **Structural Mechanics>Multibody Dynamics (mbd)**.
- 3 Click **Add**.
- 4 Click  **Study**.
- 5 In the **Select Study** tree, select **General Studies>Time Dependent**.
- 6 Click  **Done**.

## GLOBAL DEFINITIONS

### *Parameters I*



- 1 In the **Model Builder** window, under **Global Definitions** click **Parameters I**.
- 2 In the **Settings** window for **Parameters**, locate the **Parameters** section.
- 3 Click  **Load from File**.
- 4 Browse to the model's Application Libraries folder and double-click the file `slider_crank_mechanism_with_clearance_parameters.txt`.

If you do not want to import the geometry and create selections, you can load the geometry sequence from the stored model. In the **Model Builder** window, under **Component I (comp1)** right-click **Geometry I** and choose **Insert Sequence**. Browse to the model's Application Libraries folder and double-click the file `slider_crank_mechanism_with_clearance.mph`. You can then continue to the **Definitions** section below.

To import the geometry and create selections from scratch, continue here.

## GEOMETRY I

### *Import I (impl)*

- 1 In the **Model Builder** window, expand the **Component I (comp1)>Geometry I** node.
- 2 Right-click **Geometry I** and choose **Import**.
- 3 In the **Settings** window for **Import**, locate the **Import** section.
- 4 Click  **Browse**.
- 5 Browse to the model's Application Libraries folder and double-click the file `slider_crank_mechanism_with_clearance.mphbin`.
- 6 Click  **Import**.

### *Form Union (fin)*



- 1 In the **Model Builder** window, under **Component I (comp1)>Geometry I** click **Form Union (fin)**.
- 2 In the **Settings** window for **Form Union/Assembly**, locate the **Form Union/Assembly** section.
- 3 From the **Action** list, choose **Form an assembly**.
- 4 In the **Home** toolbar, click  **Build All**.

### *Support*



- 1 In the **Geometry** toolbar, click  **Selections** and choose **Explicit Selection**.
- 2 In the **Settings** window for **Explicit Selection**, type **Support** in the **Label** text field.

- 3 On the object **fin**, select Domain 1 only.
- 4 Locate the **Color** section. From the **Color** list, choose **None** or — if you are running the cross-platform desktop —**Custom**. On the cross-platform desktop, click the **Color** button.
- 5 Click **Define custom colors**.
- 6 Set the RGB values to 128, 128, and 128, respectively.
- 7 Click **Add to custom colors**.
- 8 Click **Show color palette only** or **OK** on the cross-platform desktop.
- 9 Click  **Build Selected**.

#### *Crank*



- 1 Right-click **Support** and choose **Duplicate**.
- 2 In the **Settings** window for **Explicit Selection**, type Crank in the **Label** text field.
- 3 Locate the **Entities to Select** section. Click  **Clear Selection**.
- 4 On the object **fin**, select Domain 2 only.
- 5 Locate the **Color** section. Click **Define custom colors**.
- 6 Set the RGB values to 209, 255, and 28, respectively.
- 7 Click **Add to custom colors**.
- 8 Click **Show color palette only** or **OK** on the cross-platform desktop.
- 9 Click  **Build Selected**.

#### *Connecting Rod*



- 1 Right-click **Crank** and choose **Duplicate**.
- 2 In the **Settings** window for **Explicit Selection**, type Connecting Rod in the **Label** text field.
- 3 Locate the **Entities to Select** section. Click  **Clear Selection**.
- 4 On the object **fin**, select Domain 3 only.
- 5 Locate the **Color** section. Click **Define custom colors**.
- 6 Set the RGB values to 255, 128, and 128, respectively.
- 7 Click **Add to custom colors**.
- 8 Click **Show color palette only** or **OK** on the cross-platform desktop.
- 9 Click  **Build Selected**.

#### *Slider*

- 1 Right-click **Connecting Rod** and choose **Duplicate**.

- 2 In the **Settings** window for **Explicit Selection**, type **Slider** in the **Label** text field.
- 3 Locate the **Entities to Select** section. Click  **Clear Selection**.
- 4 On the object **fin**, select **Domain 4** only.
- 5 Locate the **Color** section. Click **Define custom colors**.
- 6 Set the RGB values to 0, 255, and 255, respectively.
- 7 Click **Add to custom colors**.
- 8 Click **Show color palette only** or **OK** on the cross-platform desktop.
- 9 Click  **Build Selected**.



#### *Connecting Rod Boundaries*

- 1 In the **Geometry** toolbar, click  **Selections** and choose **Adjacent Selection**.
- 2 In the **Settings** window for **Adjacent Selection**, type **Connecting Rod Boundaries** in the **Label** text field.
- 3 Locate the **Input Entities** section. Click  **Add**.
- 4 In the **Add** dialog box, select **Connecting Rod** in the **Input selections** list.
- 5 Click **OK**.

#### *Journal Boundaries*

- 1 In the **Geometry** toolbar, click  **Selections** and choose **Explicit Selection**.
- 2 In the **Settings** window for **Explicit Selection**, type **Journal Boundaries** in the **Label** text field.
- 3 Locate the **Entities to Select** section. From the **Geometric entity level** list, choose **Boundary**.
- 4 On the object **fin**, select **Boundaries 33** and **37** only.
- 5 Select the **Group by continuous tangent** check box.

#### *Connecting Rod without Journal*

- 1 In the **Geometry** toolbar, click  **Selections** and choose **Difference Selection**.
- 2 In the **Settings** window for **Difference Selection**, type **Connecting Rod without Journal** in the **Label** text field.
- 3 Locate the **Geometric Entity Level** section. From the **Level** list, choose **Boundary**.
- 4 Locate the **Input Entities** section. Click  **Add**.
- 5 In the **Add** dialog box, select **Connecting Rod Boundaries** in the **Selections to add** list.
- 6 Click **OK**.
- 7 In the **Settings** window for **Difference Selection**, locate the **Input Entities** section.

8 Click **+** **Add**.

9 In the **Add** dialog box, select **Journal Boundaries** in the **Selections to subtract** list.

10 Click **OK**.

The identity pair between connecting rod and slider is not added automatically because of the geometric clearance. Add it manually to allow automatic joint creation functionality to create a hinge joint between the two components.

## DEFINITIONS

### *Identity Boundary Pair 3 (p3)*

1 In the **Model Builder** window, expand the **Component 1 (comp1)>Definitions** node.

2 Right-click **Definitions** and choose **Pairs>Identity Boundary Pair**.

3 Select Boundaries 31, 32, 37, and 38 only.

4 In the **Settings** window for **Pair**, locate the **Destination Boundaries** section.

5 Click to select the  **Activate Selection** toggle button.

6 Select Boundaries 42 and 43 only.

## MULTIBODY DYNAMICS (MBD)

Do as follows to generate **Rigid Domain** nodes for all components.

1 In the **Model Builder** window, under **Component 1 (comp1)** click **Multibody Dynamics (mbd)**.

2 In the **Settings** window for **Multibody Dynamics**, locate the **Automated Model Setup** section.

3 Select the **Include mass and moment of inertia node** check box. This automatically sets the density of all rigid domains to zero and adds a Mass and Moment of Inertia subnode to each Rigid Domain node.

4 Click **Physics Node Generation** in the upper-right corner of the **Automated Model Setup** section. From the menu, choose **Create Rigid Domains**.

### *Rigid Domain: Support*

1 In the **Model Builder** window, expand the **Rigid Domains (All)** node, then click **Rigid Domain 1**.

2 In the **Settings** window for **Rigid Domain**, type Rigid Domain: Support in the **Label** text field.

### *Fixed Constraint 1*

In the **Physics** toolbar, click  **Attributes** and choose **Fixed Constraint**.

### *Rigid Domain: Crank*

- 1 In the **Model Builder** window, expand the **Component 1 (comp1)>Multibody Dynamics (mbd)>Rigid Domains (All)>Rigid Domain 2** node, then click **Rigid Domain 2**.
- 2 In the **Settings** window for **Rigid Domain**, type Rigid Domain: Crank in the **Label** text field.

### *Mass and Moment of Inertia 1*

- 1 In the **Model Builder** window, click **Mass and Moment of Inertia 1**.
- 2 In the **Settings** window for **Mass and Moment of Inertia**, locate the **Mass and Moment of Inertia** section.
- 3 In the  $m$  text field, type  $m1$ .
- 4 In the **I** text field, type  $I1$ .

### *Rigid Domain: Connecting Rod*

- 1 In the **Model Builder** window, expand the **Component 1 (comp1)>Multibody Dynamics (mbd)>Rigid Domains (All)>Rigid Domain 3** node, then click **Rigid Domain 3**.
- 2 In the **Settings** window for **Rigid Domain**, type Rigid Domain: Connecting Rod in the **Label** text field.

### *Mass and Moment of Inertia 1*

- 1 In the **Model Builder** window, click **Mass and Moment of Inertia 1**.
- 2 In the **Settings** window for **Mass and Moment of Inertia**, locate the **Mass and Moment of Inertia** section.
- 3 In the  $m$  text field, type  $m2$ .
- 4 In the **I** text field, type  $I2$ .

### *Rigid Domain: Slider*

- 1 In the **Model Builder** window, expand the **Component 1 (comp1)>Multibody Dynamics (mbd)>Rigid Domains (All)>Rigid Domain 4** node, then click **Rigid Domain 4**.
- 2 In the **Settings** window for **Rigid Domain**, type Rigid Domain: Slider in the **Label** text field.

### *Mass and Moment of Inertia I*

- 1 In the **Model Builder** window, click **Mass and Moment of Inertia I**.
- 2 In the **Settings** window for **Mass and Moment of Inertia**, locate the **Mass and Moment of Inertia** section.
- 3 In the  $m$  text field, type  $m3$ .

### *Rigid Domain: Slider*

In the **Model Builder** window, click **Rigid Domain: Slider**.

### *Prescribed Displacement/Rotation I*

- 1 In the **Physics** toolbar, click  **Attributes** and choose **Prescribed Displacement/Rotation**.
- 2 In the **Settings** window for **Prescribed Displacement/Rotation**, locate the **Prescribed Displacement at Center of Rotation** section.
- 3 Select the **Prescribed in y direction** check box.
- 4 Select the **Prescribed in z direction** check box.
- 5 Locate the **Prescribed Rotation** section. From the **By** list, choose **Constrained rotation**.
- 6 Select the **Constrain rotation around x-axis** check box.
- 7 Select the **Constrain rotation around y-axis** check box.
- 8 Select the **Constrain rotation around z-axis** check box.

Do as follows to generate **Hinge Joint** nodes between components.

- 9 In the **Model Builder** window, click **Multibody Dynamics (mbd)**.
- 10 In the **Settings** window for **Multibody Dynamics**, click **Physics Node Generation** in the upper-right corner of the **Automated Model Setup** section. From the menu, choose **Create Joints**.

### *Hinge Joint I*

In the **Model Builder** window, expand the **Hinge Joints** node, then click **Hinge Joint I**.

### *Prescribed Motion I*

- 1 In the **Physics** toolbar, click  **Attributes** and choose **Prescribed Motion**.
- 2 In the **Settings** window for **Prescribed Motion**, locate the **Prescribed Rotational Motion** section.
- 3 From the **Prescribed motion through** list, choose **Angular velocity**.
- 4 In the  $\omega_p$  text field, type  $\omega$ .

- 5 Click to expand the **Reaction Force Settings** section. Select the **Evaluate reaction forces** check box.

In order to visualize the motion of the system with respect to the slider, you can use the option of defining a reference frame available in the **Multibody Dynamics** interface and plot the postprocessing variables for displacement with respect to the reference frame.

- 6 In the **Model Builder** window, click **Multibody Dynamics (mbd)**.
- 7 In the **Settings** window for **Multibody Dynamics**, click to expand the **Results** section.
- 8 From the **Body defining reference frame** list, choose **Rigid Domain: Slider**.

## MESH 1

- 1 In the **Model Builder** window, under **Component 1 (comp1)** click **Mesh 1**.
- 2 In the **Settings** window for **Mesh**, locate the **Physics-Controlled Mesh** section.
- 3 From the **Element size** list, choose **Extra fine**.
- 4 Click  **Build All**.



## STUDY 1: HINGE JOINT

- 1 In the **Model Builder** window, click **Study 1**.
- 2 In the **Settings** window for **Study**, type Study 1: Hinge Joint in the **Label** text field.

### *Step 1: Time Dependent*

- 1 In the **Model Builder** window, under **Study 1: Hinge Joint** click **Step 1: Time Dependent**.
- 2 In the **Settings** window for **Time Dependent**, locate the **Study Settings** section.
- 3 In the **Output times** text field, type range(0,0.00001,0.025).

### *Solution 1 (sol1)*

- 1 In the **Study** toolbar, click  **Show Default Solver**.
- 2 In the **Model Builder** window, expand the **Solution 1 (sol1)** node.
- 3 In the **Model Builder** window, expand the **Study 1: Hinge Joint>Solver Configurations>Solution 1 (sol1)>Dependent Variables 1** node, then click **Reaction moment (comp1.mbd.hgjl.pml.RM)**.
- 4 In the **Settings** window for **State**, locate the **Scaling** section.
- 5 In the **Scale** text field, type  $1e8*(0.1*0.22463859864235272)^3*500$ .
- 6 In the **Study** toolbar, click  **Compute**.

## RESULTS

Click the  **Show Grid** button in the **Graphics** toolbar.



#### *Displacement: Hinge Joint*

- 1 In the **Model Builder** window, under **Results** click **Displacement (mbd)**.
- 2 In the **Settings** window for **3D Plot Group**, type Displacement: Hinge Joint in the **Label** text field.

#### *Velocity: Hinge Joint*

- 1 In the **Model Builder** window, under **Results** click **Velocity (mbd)**.
- 2 In the **Settings** window for **3D Plot Group**, type Velocity: Hinge Joint in the **Label** text field.

Follow the instructions below to plot relative displacement in hinge joint case. The resulting plot should match the one shown in [Figure 3](#).

#### *Relative Displacement: Hinge Joint*

- 1 In the **Model Builder** window, right-click **Displacement: Hinge Joint** and choose **Duplicate**.
- 2 In the **Settings** window for **3D Plot Group**, type Relative Displacement: Hinge Joint in the **Label** text field.
- 3 Locate the **Plot Settings** section. From the **View** list, choose **New view**.
- 4 From the **Frame** list, choose **Material (X, Y, Z)**.

#### *Surface*

- 1 In the **Model Builder** window, expand the **Relative Displacement: Hinge Joint** node, then click **Surface**.
- 2 In the **Settings** window for **Surface**, click **Replace Expression** in the upper-right corner of the **Expression** section. From the menu, choose **Component 1 (comp1)> Multibody Dynamics>Displacement>mbd.disp\_ref - Displacement magnitude, reference frame - m**.
- 3 Locate the **Coloring and Style** section. From the **Color table** list, choose **Spectrum**.

#### *Selection 1*

Right-click **Surface** and choose **Selection**.

#### *Deformation*

In the **Settings** window for **Deformation**, click **Replace Expression** in the upper-right corner of the **Expression** section. From the menu, choose **Component 1 (comp1)> Multibody Dynamics>Displacement>u\_ref,...,w\_ref - Displacement field, reference frame (spatial frame)**.

#### *Selection 1*

- 1 In the **Model Builder** window, click **Selection 1**.

- 2 In the **Settings** window for **Selection**, locate the **Selection** section.
- 3 From the **Selection** list, choose **Journal Boundaries**.

#### *Contour 1*

- 1 In the **Model Builder** window, right-click **Relative Displacement: Hinge Joint** and choose **Contour**.
- 2 In the **Settings** window for **Contour**, locate the **Expression** section.
- 3 In the **Expression** text field, type `mbd.disp_ref`.
- 4 Click to expand the **Title** section. From the **Title type** list, choose **None**.
- 5 Locate the **Coloring and Style** section. From the **Color table** list, choose **Spectrum**.
- 6 Clear the **Color legend** check box.

#### *Deformation 1*

- 1 Right-click **Contour 1** and choose **Deformation**.
- 2 In the **Settings** window for **Deformation**, click **Replace Expression** in the upper-right corner of the **Expression** section. From the menu, choose **Component 1 (comp1)>Multibody Dynamics>Displacement>u\_ref,...,w\_ref - Displacement field, reference frame (spatial frame)**.
- 3 Locate the **Scale** section. Select the **Scale factor** check box.
- 4 In the associated text field, type 1.

#### *Selection 1*

- 1 In the **Model Builder** window, right-click **Contour 1** and choose **Selection**.
- 2 In the **Settings** window for **Selection**, locate the **Selection** section.
- 3 From the **Selection** list, choose **Journal Boundaries**.

#### *Surface 2*

- 1 In the **Model Builder** window, right-click **Surface** and choose **Duplicate**.
- 2 In the **Settings** window for **Surface**, click **Replace Expression** in the upper-right corner of the **Expression** section. From the menu, choose **Geometry>dom - Entity index**.
- 3 Click to expand the **Title** section. From the **Title type** list, choose **None**.
- 4 Locate the **Coloring and Style** section. From the **Coloring** list, choose **Uniform**.
- 5 From the **Color** list, choose **Custom**.
- 6 On Windows, click the colored bar underneath, or — if you are running the cross-platform desktop — the **Color** button.
- 7 Click **Define custom colors**.

- 8 Set the RGB values to 255, 128, and 128, respectively.
- 9 Click **Add to custom colors**.
- 10 Click **Show color palette only** or **OK** on the cross-platform desktop.

#### *Selection 1*

- 1 In the **Model Builder** window, expand the **Surface 2** node, then click **Selection 1**.
- 2 In the **Settings** window for **Selection**, locate the **Selection** section.
- 3 From the **Selection** list, choose **Connecting Rod without Journal**.

#### *Volume 1*

- 1 In the **Model Builder** window, right-click **Relative Displacement: Hinge Joint** and choose **Volume**.
- 2 In the **Settings** window for **Volume**, click **Replace Expression** in the upper-right corner of the **Expression** section. From the menu, choose **Geometry>dom - Entity index**.
- 3 Click to expand the **Title** section. From the **Title type** list, choose **None**.
- 4 Locate the **Coloring and Style** section. From the **Coloring** list, choose **Uniform**.
- 5 From the **Color** list, choose **Cyan**.

#### *Selection 1*

- 1 Right-click **Volume 1** and choose **Selection**.
- 2 Select Domain 4 only.

#### *Transparency 1*

- 1 In the **Model Builder** window, right-click **Volume 1** and choose **Transparency**.
- 2 In the **Settings** window for **Transparency**, locate the **Transparency** section.
- 3 Set the **Transparency** value to **0.75**.

#### *Deformation 1*

- 1 Right-click **Volume 1** and choose **Deformation**.
- 2 In the **Settings** window for **Deformation**, click **Replace Expression** in the upper-right corner of the **Expression** section. From the menu, choose **Component 1 (comp1)>Multibody Dynamics>Displacement>u\_ref,...,w\_ref - Displacement field, reference frame (spatial frame)**.
- 3 Locate the **Scale** section. Select the **Scale factor** check box.
- 4 In the associated text field, type 1.

#### *Volume 2*

- 1 Right-click **Volume 1** and choose **Duplicate**.

- 2 In the **Settings** window for **Volume**, locate the **Coloring and Style** section.
- 3 From the **Coloring** list, choose **Color table**.
- 4 From the **Color table** list, choose **TrafficLight**.
- 5 Clear the **Color legend** check box.

#### *Selection 1*

- 1 In the **Model Builder** window, expand the **Volume 2** node, then click **Selection 1**.
- 2 In the **Settings** window for **Selection**, locate the **Selection** section.
- 3 Click  **Clear Selection**.
- 4 Select Domains 1 and 2 only.

#### *Transparency 1*

In the **Model Builder** window, under **Results>Relative Displacement: Hinge Joint>Volume 2** right-click **Transparency 1** and choose **Delete**.

#### *Relative Displacement: Hinge Joint*

- 1 In the **Model Builder** window, under **Results** click **Relative Displacement: Hinge Joint**.
- 2 In the **Relative Displacement: Hinge Joint** toolbar, click  **Plot**.

## **MULTIBODY DYNAMICS (MBD)**

#### *Clearance Joint 1*

- 1 In the **Physics** toolbar, click  **Global** and choose **Clearance Joint**.
- 2 In the **Settings** window for **Clearance Joint**, locate the **Attachment Selection** section.
- 3 From the **Source** list, choose **Rigid Domain: Connecting Rod**.
- 4 From the **Connection point** list, choose **Centroid of selected entities**.

#### *Source Point: Boundary 1*



- 1 In the **Model Builder** window, click **Source Point: Boundary 1**.
- 2 In the **Settings** window for **Source Point: Boundary**, locate the **Boundary Selection** section.
- 3 From the **Selection** list, choose **Journal Boundaries**.
- 4 In the list, select **33**.
- 5 Click  **Remove from Selection**.
- 6 Select Boundaries 31, 32, 37, and 38 only.

#### *Clearance Joint 1*

- 1 In the **Model Builder** window, click **Clearance Joint 1**.

- 2 In the **Settings** window for **Clearance Joint**, locate the **Attachment Selection** section.
- 3 From the **Destination** list, choose **Rigid Domain: Slider**.
- 4 Locate the **Clearance Settings** section. In the *C* text field, type *C*.
- 5 In the *p<sub>j</sub>* text field, type  $\text{mbd.crj1.Eequ}*(0.1*\text{mbd.diag})/100$ .

#### ADD STUDY

- 1 In the **Home** toolbar, click  **Add Study** to open the **Add Study** window.
- 2 Go to the **Add Study** window.
- 3 Find the **Studies** subsection. In the **Select Study** tree, select **General Studies>Time Dependent**.
- 4 Click **Add Study** in the window toolbar.
- 5 In the **Home** toolbar, click  **Add Study** to close the **Add Study** window.

#### STUDY 2: CLEARANCE JOINT

- 1 In the **Model Builder** window, click **Study 2**.
- 2 In the **Settings** window for **Study**, type Study 2: Clearance Joint in the **Label** text field.

##### *Step 1: Time Dependent*

- 1 In the **Model Builder** window, under **Study 2: Clearance Joint** click **Step 1: Time Dependent**.
- 2 In the **Settings** window for **Time Dependent**, locate the **Study Settings** section.
- 3 In the **Output times** text field, type  $\text{range}(0, 0.00001, 0.025)$ .
- 4 Locate the **Physics and Variables Selection** section. Select the **Modify model configuration for study step** check box.
- 5 In the tree, select **Component 1 (Comp 1)>Multibody Dynamics (Mbd)>Hinge Joints>Hinge Joint 3**.
- 6 Right-click and choose **Disable**.

##### *Solution 2 (sol2)*

- 1 In the **Study** toolbar, click  **Show Default Solver**.
- 2 In the **Model Builder** window, expand the **Solution 2 (sol2)** node.
- 3 In the **Model Builder** window, expand the **Study 2: Clearance Joint>Solver Configurations>Solution 2 (sol2)>Dependent Variables 1** node, then click **Reaction moment (comp1.mbd.hgjl.pml.RM)**.
- 4 In the **Settings** window for **State**, locate the **Scaling** section.
- 5 In the **Scale** text field, type  $1\text{e}8*(0.1*0.22463859864235272)^3*500$ .

6 In the **Study** toolbar, click  **Compute**.

## RESULTS

### *Displacement: Clearance Joint*

In the **Settings** window for **3D Plot Group**, type Displacement: Clearance Joint in the **Label** text field.

### *Velocity: Clearance Joint*

1 In the **Model Builder** window, under **Results** click **Velocity (mbd)**.

2 In the **Settings** window for **3D Plot Group**, type Velocity: Clearance Joint in the **Label** text field.

Follow the instructions below to plot relative displacement in clearance joint case. The resulting plot should match the one shown in [Figure 3](#).

### *Relative Displacement: Clearance Joint*

1 In the **Model Builder** window, right-click **Relative Displacement: Hinge Joint** and choose **Duplicate**.

2 In the **Settings** window for **3D Plot Group**, type Relative Displacement: Clearance Joint in the **Label** text field.

3 Locate the **Data** section. From the **Dataset** list, choose **Study 2: Clearance Joint/ Solution 2 (sol2)**.

4 In the **Relative Displacement: Clearance Joint** toolbar, click  **Plot**.

Follow the instructions below to plot slider velocity. The resulting plot should match the one shown in [Figure 4](#).

### *Slider Velocity*

1 In the **Home** toolbar, click  **Add Plot Group** and choose **ID Plot Group**.

2 In the **Settings** window for **ID Plot Group**, type Slider Velocity in the **Label** text field.

3 Click to expand the **Title** section. From the **Title type** list, choose **Label**.

4 Locate the **Legend** section. From the **Position** list, choose **Upper left**.

### *Global 1*

1 Right-click **Slider Velocity** and choose **Global**.

2 In the **Settings** window for **Global**, click **Replace Expression** in the upper-right corner of the **y-Axis Data** section. From the menu, choose **Component 1 (comp1)> Multibody Dynamics>Rigid domains>Rigid Domain: Slider>**

**Rigid body velocity (spatial frame) - m/s>mbd.rd4.u\_tx - Rigid body velocity, x component.**

**3** Locate the **y-Axis Data** section. In the table, enter the following settings:

Expression	Unit	Description
mbd.rd4.u_tx	m/s	Hinge joint

#### *Global 2*

- 1** Right-click **Global 1** and choose **Duplicate**.
- 2** In the **Settings** window for **Global**, locate the **Data** section.
- 3** From the **Dataset** list, choose **Study 2: Clearance Joint/Solution 2 (sol2)**.
- 4** Locate the **y-Axis Data** section. In the table, enter the following settings:

Expression	Unit	Description
mbd.rd4.u_tx	m/s	Clearance joint

#### *Slider Velocity*

- 1** In the **Model Builder** window, click **Slider Velocity**.
- 2** In the **Settings** window for **ID Plot Group**, locate the **Plot Settings** section.
- 3** Select the **y-axis label** check box.
- 4** In the associated text field, type Rigid body velocity (m/s).
- 5** In the **Slider Velocity** toolbar, click  **Plot**.

Follow the instructions below to plot slider acceleration. The resulting plot should match the one shown in [Figure 5](#).

#### *Slider Acceleration*

- 1** Right-click **Slider Velocity** and choose **Duplicate**.
- 2** In the **Settings** window for **ID Plot Group**, type Slider Acceleration in the **Label** text field.
- 3** Locate the **Plot Settings** section. In the **y-axis label** text field, type Rigid body acceleration (m/s<sup>2</sup>).
- 4** Locate the **Legend** section. From the **Position** list, choose **Upper right**.

#### *Global 1*

- 1** In the **Model Builder** window, expand the **Slider Acceleration** node, then click **Global 1**.
- 2** In the **Settings** window for **Global**, locate the **y-Axis Data** section.

3 In the table, enter the following settings:

Expression	Unit	Description
mbd.rd4.u_ttx	m/s <sup>2</sup>	Hinge joint

#### Global 2

- 1 In the **Model Builder** window, click **Global 2**.
- 2 In the **Settings** window for **Global**, locate the **y-Axis Data** section.
- 3 In the table, enter the following settings:

Expression	Unit	Description
mbd.rd4.u_ttx	m/s <sup>2</sup>	Clearance joint

Follow the instructions below to plot crank reaction moment. The resulting plot should match the one shown in [Figure 6](#).

#### Reaction Moment

- 1 In the **Model Builder** window, right-click **Slider Acceleration** and choose **Duplicate**.
- 2 In the **Settings** window for **ID Plot Group**, type Reaction Moment in the **Label** text field.
- 3 Locate the **Plot Settings** section. In the **y-axis label** text field, type Reaction moment (N\*m).

#### Global 1

- 1 In the **Model Builder** window, expand the **Reaction Moment** node, then click **Global 1**.
- 2 In the **Settings** window for **Global**, locate the **y-Axis Data** section.
- 3 In the table, enter the following settings:

Expression	Unit	Description
mbd.hgj1.pm1.RM	N*m	Hinge joint

#### Global 2

- 1 In the **Model Builder** window, click **Global 2**.
- 2 In the **Settings** window for **Global**, locate the **y-Axis Data** section.
- 3 In the table, enter the following settings:

Expression	Unit	Description
mbd.hgj1.pm1.RM	N*m	Clearance joint

- 4 In the **Reaction Moment** toolbar, click  **Plot**.



Follow the instructions below to plot journal trajectory for clearance joint case. The resulting plot should match the one shown in [Figure 7](#).

#### *Journal Trajectory: Clearance Joint*

- 1 In the **Home** toolbar, click  **Add Plot Group** and choose **3D Plot Group**.
- 2 In the **Settings** window for **3D Plot Group**, type Journal Trajectory: Clearance Joint in the **Label** text field.
- 3 Locate the **Data** section. From the **Dataset** list, choose **Study 2: Clearance Joint/ Solution 2 (sol2)**.
- 4 Click to expand the **Title** section. From the **Title type** list, choose **Label**.
- 5 Locate the **Plot Settings** section. From the **View** list, choose **New view**.
- 6 Clear the **Plot dataset edges** check box.

#### *Point Trajectories I*

- 1 In the **Journal Trajectory: Clearance Joint** toolbar, click  **More Plots** and choose **Point Trajectories**.
- 2 In the **Settings** window for **Point Trajectories**, locate the **Trajectory Data** section.
- 3 From the **Plot data** list, choose **Global**.
- 4 Click **Replace Expression** in the upper-right corner of the **Trajectory Data** section. From the menu, choose **Component 1 (comp1)>Multibody Dynamics>Clearance joints> Clearance Joint 1>mbd.crj1.dx,...,mbd.crj1.dz - Instantaneous distance**.
- 5 Locate the **Coloring and Style** section. Find the **Line style** subsection. From the **Type** list, choose **Tube**.
- 6 In the **Tube radius expression** text field, type  $1e-8$ .
- 7 Select the **Radius scale factor** check box.
- 8 In the associated text field, type 500.

#### *Color Expression I*



- 1 Right-click **Point Trajectories I** and choose **Color Expression**.
- 2 In the **Settings** window for **Color Expression**, locate the **Expression** section.
- 3 In the **Expression** text field, type  $t$ .
- 4 Locate the **Coloring and Style** section. From the **Color table** list, choose **RainbowLight**.
- 5 Clear the **Color legend** check box.

#### *Parameterized Curve 3D I*

- 1 In the **Results** toolbar, click  **More Datasets** and choose **Parameterized Curve 3D**.

- 2 In the **Settings** window for **Parameterized Curve 3D**, locate the **Data** section.
- 3 From the **Dataset** list, choose **Study 2: Clearance Joint/Solution 2 (sol2)**.
- 4 Locate the **Parameter** section. In the **Maximum** text field, type  $2*\pi$ .
- 5 Locate the **Expressions** section. In the **x** text field, type  $C*\sin(s)$ .
- 6 In the **z** text field, type  $C*\cos(s)$ .

*Line 1*

- 1 In the **Model Builder** window, right-click **Journal Trajectory: Clearance Joint** and choose **Line**.
- 2 In the **Settings** window for **Line**, locate the **Data** section.
- 3 From the **Dataset** list, choose **Parameterized Curve 3D 1**.
- 4 Locate the **Expression** section. In the **Expression** text field, type 1.
- 5 Locate the **Coloring and Style** section. From the **Line type** list, choose **Tube**.
- 6 In the **Tube radius expression** text field, type  $1e-8$ .
- 7 Select the **Radius scale factor** check box.
- 8 In the associated text field, type 500.
- 9 From the **Coloring** list, choose **Uniform**.
- 10 From the **Color** list, choose **Magenta**.
- 11 In the **Journal Trajectory: Clearance Joint** toolbar, click  **Plot**.
- 12 Click the  **Zoom Extents** button in the **Graphics** toolbar.

Follow the instructions below to plot force in clearance joint. The resulting plot should match the one shown in [Figure 8](#).

*Joint Force: Clearance Joint*

- 1 In the **Home** toolbar, click  **Add Plot Group** and choose **ID Plot Group**.
- 2 In the **Settings** window for **ID Plot Group**, type **Joint Force: Clearance Joint** in the **Label** text field.
- 3 Locate the **Data** section. From the **Dataset** list, choose **Study 2: Clearance Joint/Solution 2 (sol2)**.
- 4 Locate the **Title** section. From the **Title type** list, choose **Label**.
- 5 Locate the **Legend** section. Clear the **Show legends** check box.

*Global 1*

- 1 Right-click **Joint Force: Clearance Joint** and choose **Global**.

- 2 In the **Settings** window for **Global**, click **Replace Expression** in the upper-right corner of the **y-Axis Data** section. From the menu, choose **Component 1 (comp1)>Multibody Dynamics>Clearance joints>Clearance Joint 1>mbd.crj1.Fj - Joint force magnitude - N**.
- 3 In the **Joint Force: Clearance Joint** toolbar, click  **Plot**.

Follow the instructions below to plot gap distance in clearance joint. The resulting plot should match the one shown in [Figure 9](#).

#### *Gap Distance: Clearance Joint*

- 1 In the **Home** toolbar, click  **Add Plot Group** and choose **Polar Plot Group**.
- 2 In the **Settings** window for **Polar Plot Group**, type **Gap Distance: Clearance Joint** in the **Label** text field.
- 3 Locate the **Data** section. From the **Dataset** list, choose **Study 2: Clearance Joint/ Solution 2 (sol2)**.
- 4 Click to expand the **Title** section. From the **Title type** list, choose **Label**.
- 5 Locate the **Grid** section. Clear the **Show grid** check box.
- 6 Locate the **Legend** section. Clear the **Show legends** check box.

#### *Global 1*

- 1 Right-click **Gap Distance: Clearance Joint** and choose **Global**.
- 2 In the **Settings** window for **Global**, click **Replace Expression** in the upper-right corner of the **r-Axis Data** section. From the menu, choose **Component 1 (comp1)>Multibody Dynamics>Clearance joints>Clearance Joint 1>mbd.crj1.gap - Gap distance - m**.
- 3 Locate the  **$\theta$  Angle Data** section. From the **Parameter** list, choose **Expression**.
- 4 In the **Expression** text field, type **mbd.hgj1.th**.
- 5 Click to expand the **Coloring and Style** section. In the **Width** text field, type **2**.

#### *Global 2*

- 1 Right-click **Global 1** and choose **Duplicate**.
- 2 In the **Settings** window for **Global**, locate the **r-Axis Data** section.
- 3 In the table, enter the following settings:

Expression	Unit	Description
0	1	

- 4 Locate the **Coloring and Style** section. Find the **Line style** subsection. From the **Line** list, choose **Dotted**.

- 5 From the **Color** list, choose **Magenta**.

#### *Color Expression I*

- 1 In the **Model Builder** window, right-click **Global I** and choose **Color Expression**.
- 2 In the **Settings** window for **Color Expression**, locate the **Expression** section.
- 3 In the **Expression** text field, type **t**.
- 4 Locate the **Coloring and Style** section. From the **Color table** list, choose **RainbowLight**.
- 5 In the **Gap Distance: Clearance Joint** toolbar, click  **Plot**.

#### *Displacement: Hinge Joint*

- 1 In the **Results** toolbar, click  **Animation** and choose **Player**.
- 2 In the **Settings** window for **Animation**, type **Displacement: Hinge Joint** in the **Label** text field.
- 3 Locate the **Frames** section. In the **Number of frames** text field, type **50**.

#### *Displacement: Clearance Joint*

- 1 Right-click **Displacement: Hinge Joint** and choose **Duplicate**.
- 2 In the **Settings** window for **Animation**, type **Displacement: Clearance Joint** in the **Label** text field.
- 3 Locate the **Scene** section. From the **Subject** list, choose **Displacement: Clearance Joint**.

#### *Relative Displacement: Hinge Joint*

- 1 In the **Model Builder** window, right-click **Displacement: Hinge Joint** and choose **Duplicate**.
- 2 In the **Settings** window for **Animation**, type **Relative Displacement: Hinge Joint** in the **Label** text field.
- 3 Locate the **Scene** section. From the **Subject** list, choose **Relative Displacement: Hinge Joint**.

#### *Relative Displacement: Clearance Joint*

- 1 Right-click **Relative Displacement: Hinge Joint** and choose **Duplicate**.
- 2 In the **Settings** window for **Animation**, type **Relative Displacement: Clearance Joint** in the **Label** text field.
- 3 Locate the **Scene** section. From the **Subject** list, choose **Relative Displacement: Clearance Joint**.

#### *Journal Trajectory: Clearance Joint*

- 1 Right-click **Relative Displacement: Clearance Joint** and choose **Duplicate**.
- 2 In the **Settings** window for **Animation**, type **Journal Trajectory: Clearance Joint** in the **Label** text field.

**3** Locate the **Scene** section. From the **Subject** list, choose **Journal Trajectory: Clearance Joint**.

