



# Three-Cylinder Reciprocating Engine

## Introduction

---

A multibody analysis of an engine is often performed considering the individual components as rigid bodies. However, as specific power and engine speed requirements increase together with a need to improve overall efficiency, it is important to understand the critical points in an engine assembly in order to optimize the engine design. In this model, a combination of rigid and flexible body analysis is displayed.

Two types of analyses are shown in this example:

- A simplified thermodynamic analysis of an air-fuel mixture in an engine cylinder.
- A multibody dynamics analysis of an engine assembly.

In the thermodynamic analysis, the pressure variation in the combustion chamber due to the compression and combustion of air-fuel mixture is determined. This analysis is performed using the Heat Transfer and Coefficient Form PDE interfaces.

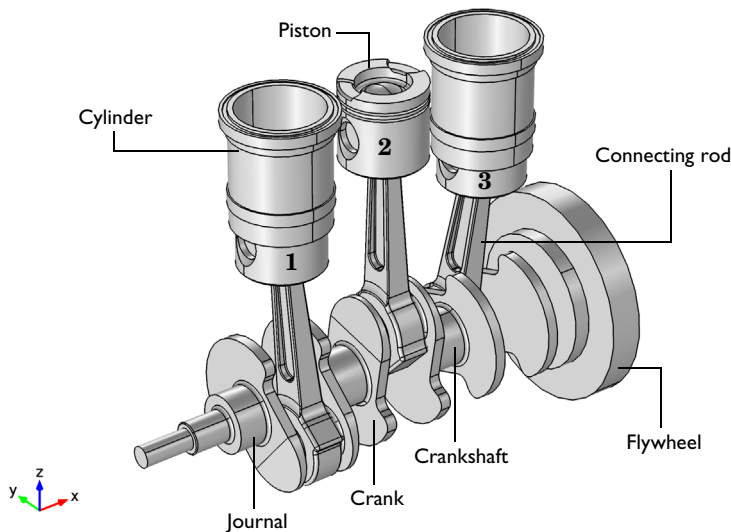

*Figure 1: Geometry of the three-cylinder reciprocating engine.*

In the multibody analysis, the pressure data obtained from the thermodynamic analysis is used to compute the motion of different components of an engine assembly, the RPM of the engine, and the power output (BHP) of the engine. This analysis is performed using the Multibody Dynamics interface. One of the connecting rods is studied from a

component design perspective, and is modeled as a flexible element. The variation of the maximum stress in this component with the crankshaft rotation is analyzed.

The discussions about the thermodynamic study in this model are not required to understand the multibody dynamics modeling, so if you are only interested in the latter, you can skip all descriptions of the first study.

---

**Note:** This model requires the Heat Transfer Module if the thermodynamic analysis is performed. For a pure multibody analysis, only the Multibody Dynamics Module is required.

---

### *Model Definition*

---

#### **THERMODYNAMIC ANALYSIS**

The pressure variation in one of the cylinders is determined during one full revolution of a crankshaft. The geometry modeled in this analysis is shown in [Figure 2](#). It is created from the engine geometry shown in [Figure 1](#) by cutting the 3D geometry through a work-plane ( $xz$ -plane), thus generating a planar 2D geometry.

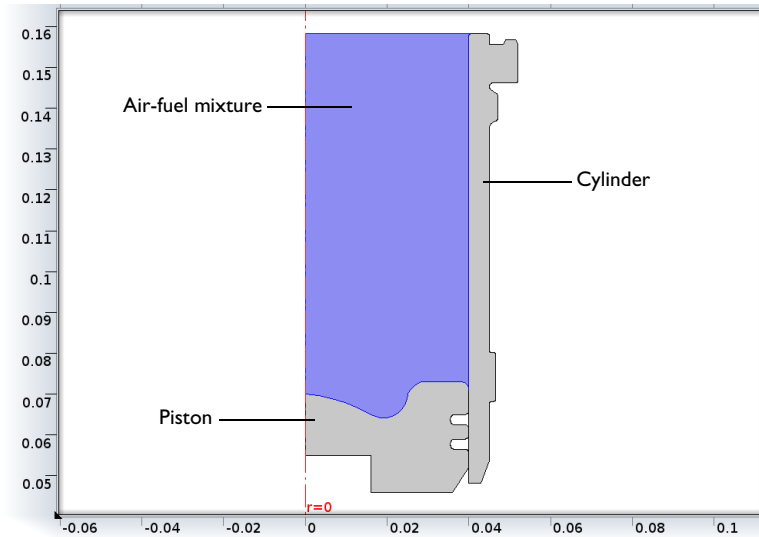

*Figure 2: Axisymmetric view of the piston-cylinder assembly. Only the highlighted domain, where the air-fuel mixture is present, is modeled.*

This analysis is a simplified form of an actual combustion analysis. The purpose of this analysis is to show how you can determine the cylinder pressure variation required for the multibody analysis. The following assumptions and simplifications are used in this analysis:

- Only air is considered as a fluid in the combustion chamber.
- The heat energy, generated by combustion, is added uniformly over the domain.
- The convection effects in the combustion chamber are neglected.
- All the equations are solved in the original domain, and the effect of the change in the cylinder volume is accounted for manually in the equations.

The temperature distribution in the air inside the cylinder is modeled using the heat transfer equations. The pressure work is also added to account for the rise in temperature due to the work done by the piston. The pressure distribution in the air is modeled using an ideal gas equation:

$$p = \frac{m}{V}RT$$

where  $p$ ,  $m$ ,  $V$ ,  $R$ , and  $T$  represent the pressure, mass, current volume, specific gas constant, and temperature respectively.

The current cylinder volume,  $V$ , is computed by subtracting the piston swept volume from the initial cylinder volume. The piston displacement,  $x_p$ , as a function of the crankshaft rotation,  $\theta$ , can be written as

$$x_p = \sqrt{l^2 - (r_c \sin \theta)^2} - r_c \cos \theta - (l - r_c)$$

where  $x_p$ ,  $r_c$ ,  $l$ , and  $\theta$  represent the piston displacement, crank radius, connecting rod length and crank angle, respectively.

During the combustion, it is assumed that a total energy of 600 J is generated in one cycle during the crankshaft rotation from 3° before top dead center (TDC) to 6° after TDC.

### **MULTIBODY ANALYSIS**

In this analysis, the pressure data obtained from the thermodynamic analysis is used to drive the motion of the engine assembly. The engine assembly is shown in [Figure 1](#).

The engine assembly consists of a crankshaft, a flywheel, and three identical sets of cylinders, pistons and connecting rods. Each cylinder is connected to a piston through a prismatic joint and each piston is connected to the top end of a connecting rod through a hinge joint. The bottom end of all three connecting rods are connected to the common crankshaft through hinge joints. The flywheel is mounted on the crankshaft, and this crankshaft-flywheel assembly is supported by journal bearings at both ends.

All the components of the engine are assumed to be rigid, except the central connecting rod which is flexible and uses the material data for structural steel.

All the cylinders are fixed, while the other components are free to move in space. The pressure variation obtained from the thermodynamic analysis, with appropriate phase difference, is applied on the top surface of each piston. A starting torque of 400 Nm is applied on the crankshaft to start the engine until the shaft has rotated 60°. For the first one and a half revolutions of the crankshaft, the engine runs on a no-load condition. After that, an external load proportional to the angular velocity of the crankshaft is applied. Due to this external load, the RPM of the engine slowly reaches a steady state value.

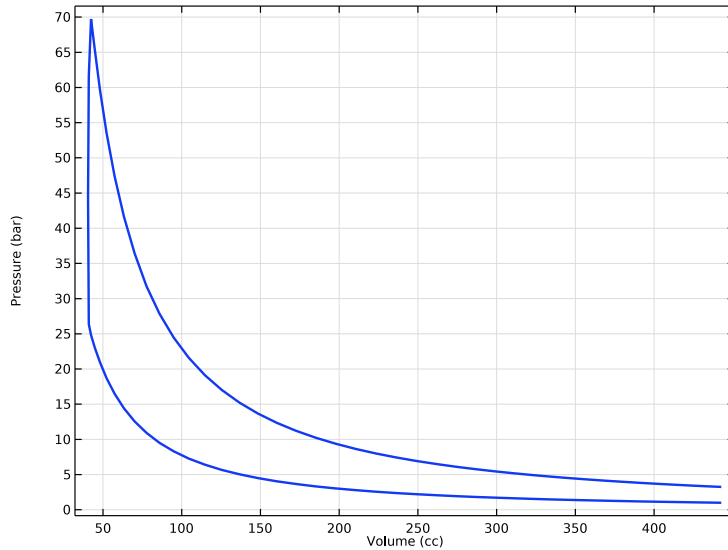

*Figure 3: P-V diagram for one of the cylinders.*

The P-V diagram for one of the cylinders of the engine, as computed from the thermodynamic analysis, is shown in [Figure 3](#). During the compression stroke, the volume of the air-fuel mixture decreases, and hence the pressure increases until the piston reaches close to the top dead center (TDC). At this point, the combustion occurs, which in turn increases the temperature and the pressure of the mixture. Finally, highly pressurized gas in the cylinder pushes the piston back toward the bottom dead center (BDC), thus performing the expansion stroke. During the expansion process, the pressure of the mixture decreases. The enclosed area of this diagram is a measure of the mechanical energy generated over one full cycle of the crankshaft rotation.

[Figure 4](#) shows the variation of the cylinder pressure with the crankshaft rotation. You can clearly observe the compression, combustion and expansion strokes in this curve. The curve is exported and used to prescribe the pressure on the top surface of the piston in the multibody analysis.

The heat energy that was converted into mechanical energy in one full revolution of the crankshaft is also computed. The mechanical energy generated per cycle is approximately 339 J, whereas the input heat energy per cycle is 600 J. This shows that the remaining part

of the heat energy is lost in the exhaust gases, so the thermal efficiency of the system is around 57 %.

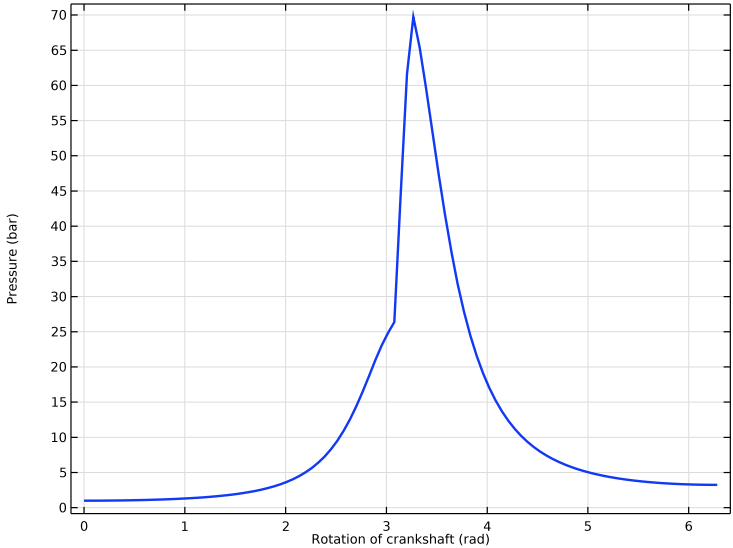

Figure 4: Variation of the cylinder pressure with the crank rotation.

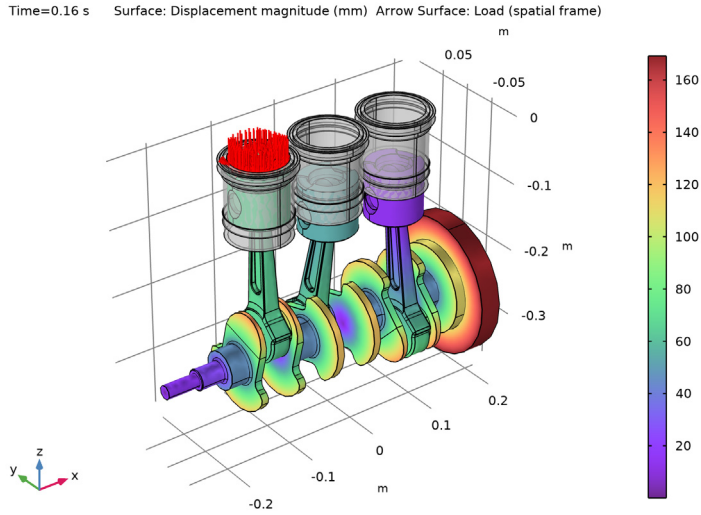

Figure 5: Displacements of the engine components.

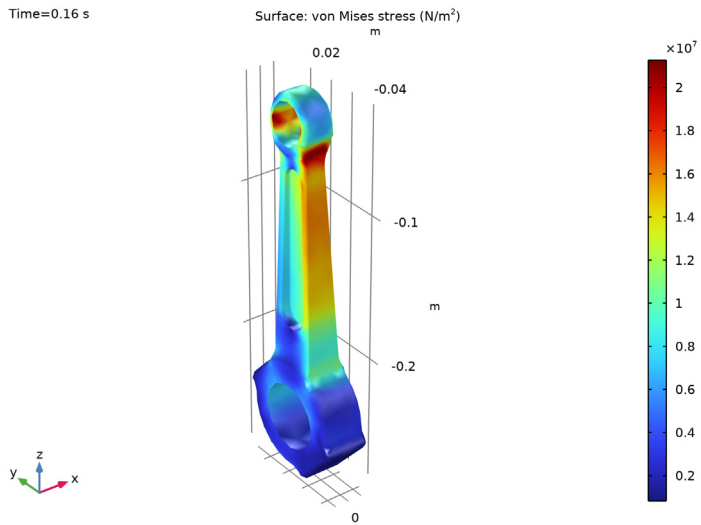

Figure 6: von Mises stress in the flexible connecting rod at 0.16 s.



The displacement of the various components of the engine at  $t = 0.16$  s, computed in the multibody analysis, is shown in [Figure 5](#).

[Figure 6](#) shows the stress distribution in the flexible connecting rod at  $t = 0.16$  s. The maximum stresses occur near the top part of the connecting rod.

[Figure 7](#) displays the time history of the RPM of the engine. The starting torque applied in the beginning of the simulation increases the engine RPM rapidly. After the removal of the starting torque, the RPM increases steadily as there is no external load. Finally after the application of the external load, it approaches a steady-state value close to 2600.

The fluctuations in the engine RPM are caused by the different strokes in a cycle, namely, compression stroke, combustion, and power stroke. During the power stroke, the piston is pushed to accelerate the crankshaft whereas during the compression stroke, the air-fuel mixture in the cylinder is compressed by the inertia of the components. The  $120^\circ$  phase difference between the cylinders makes the angular speed of the crankshaft more uniform. In addition, the flywheel mounted on the crankshaft also helps in making the speed uniform by absorbing the energy during the power stroke and delivering it during the compression stroke.

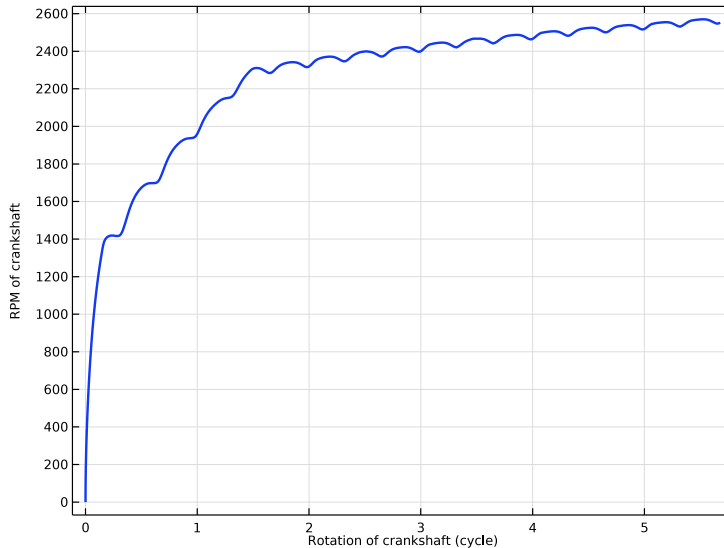

*Figure 7: Time history of the engine RPM.*

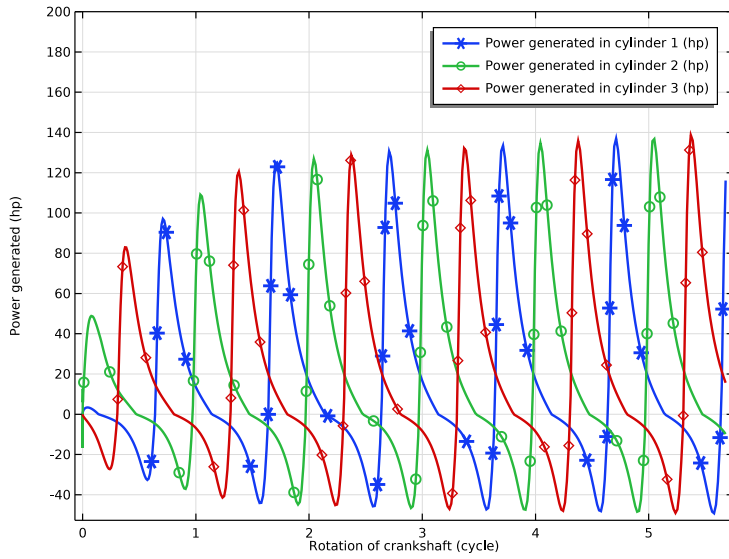

Figure 8: Mechanical power generated in each cylinder.

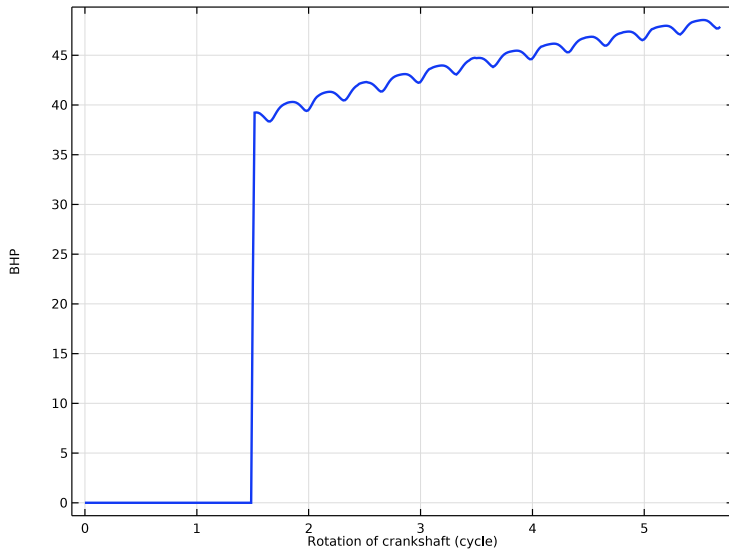

Figure 9: Power output (BHP) of the engine.

Figure 8 displays the mechanical power generated in each cylinder. It can be noted that during the compression stroke, the power generated is negative and it suddenly reverts its sign during the combustion, after which the power generated is positive. The time average of the power over a cycle is the net mechanical power generated in one revolution of the crankshaft. The  $120^\circ$  phase shift between the three sets of cylinder-piston can also be seen.

The power output due to the applied external load is shown in Figure 9. It shows that the engine initially runs on a no-load condition. Once an external load is applied, the power output of the engine (BHP) increases and approaches a steady state value close to 50 bhp.

Figure 10 shows the variation of the maximum stress in the flexible connecting rod during its operation. The connecting rod is subjected to a cyclic loading with stresses having a maximum when the piston is at TDC. The values of maximum and minimum stresses in one cycle are close to 160 MPa and 5 MPa respectively. It should be noted that the displayed stress history does not occur in a single point, since it for each time instance shows the maximum equivalent stress in any point in the connecting rod. This curve can thus not form the basis for a fatigue analysis.

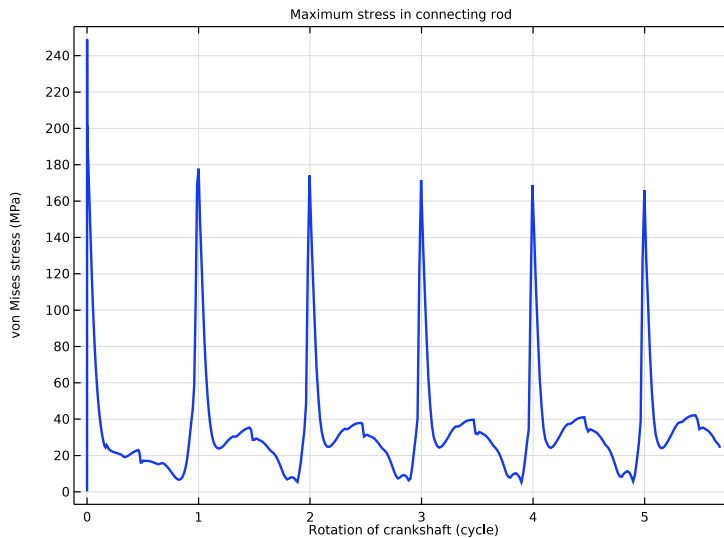

Figure 10: Variation of the maximum stress generated in the flexible connecting rod.

Figure 11 shows the forces in the joint between the flexible connecting rod and crankpin. The forces are largest in the  $z$  direction and almost zero in the  $x$  direction.

These forces obtain their maxima when the piston is near TDC. The change of sign in these forces signify that the flexible connecting rod shifts from a state of compression to a state of tension during its operation. This serves to increase the need for a proper fatigue design.

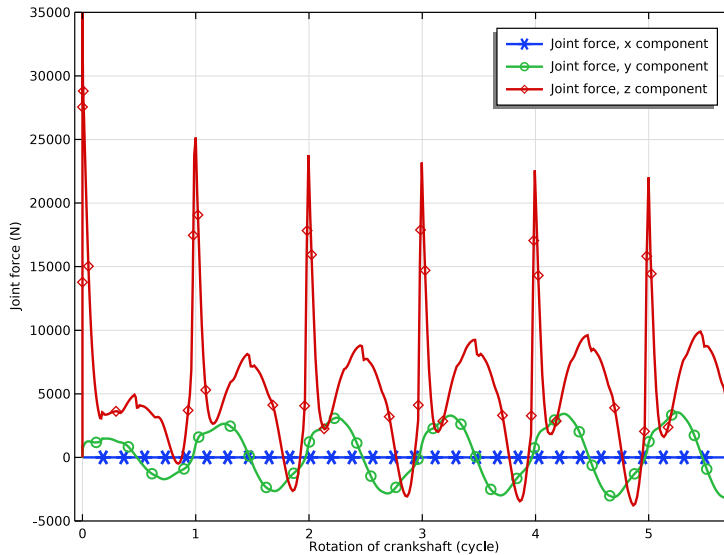

Figure 11: Forces at the joint between the flexible connecting rod and crankpin.

### Notes About the COMSOL Implementation

- A **Joint** node can establish a direct connection between **Rigid Domain** nodes. However, for flexible elements, **Attachment** nodes are needed to define the connection boundaries.
- Constraint boundary conditions like **Prescribed Displacement** cannot be used with a **Rigid Domain** node. Hence, the **Prescribed Displacement/Rotation** node (subnode to **Rigid Domain**) is used to constrain or prescribe the corresponding degrees of freedom.
- The connections used in the model can be reviewed in the **Joints Summary** section at the interface settings.
- The shape function order for flexible components, is by default set to **Linear**. For better accuracy, you can switch it to **Quadratic**.

---

**Application Library path:** Multibody\_Dynamics\_Module/  
Automotive\_and\_Aerospace/reciprocating\_engine

---

## *Modeling Instructions*

---

### *Part 1: Thermodynamic Analysis*

---



The thermodynamic analysis is performed in order to compute the cylinders pressure variation as a function of the crankshaft rotation. This part is optional, and you can skip it and start directly at the second part of the example, the multibody dynamics analysis.

From the **File** menu, choose **New**.

#### **NEW**

In the **New** window, click  **Model Wizard**.

#### **MODEL WIZARD**

- 1 In the **Model Wizard** window, click  **2D Axisymmetric**.
- 2 In the **Select Physics** tree, select **Heat Transfer>Heat Transfer in Fluids (ht)**.
- 3 Click **Add**.
- 4 In the **Select Physics** tree, select **Mathematics>PDE Interfaces>Coefficient Form PDE (c)**.
- 5 Click **Add**.
- 6 Click  **Study**.
- 7 In the **Select Study** tree, select **General Studies>Time Dependent**.
- 8 Click  **Done**.



#### **THERMODYNAMIC ANALYSIS**

- 1 In the **Model Builder** window, click **Component 1 (comp1)**.
- 2 In the **Settings** window for **Component**, type Thermodynamic Analysis in the **Label** text field.

#### **GEOMETRY 1**

*Import 1 (imp1)*

- 1 In the **Home** toolbar, click  **Import**.

- 2 In the **Settings** window for **Import**, locate the **Import** section.
- 3 Click  **Browse**.
- 4 Browse to the model's Application Libraries folder and double-click the file `reciprocating_engine_2d.mphbin`.
- 5 Click  **Import**.
- 6 Click the  **Zoom Extents** button in the **Graphics** toolbar.  
Use a rectangle function to add heat due to combustion while the crankshaft rotates from 3 **deg** before TDC to 6 **deg** after TDC.

## DEFINITIONS

### *Rectangle 1 (rect1)*

- 1 In the **Home** toolbar, click  **Functions** and choose **Local>Rectangle**.
- 2 In the **Settings** window for **Rectangle**, locate the **Parameters** section.
- 3 In the **Lower limit** text field, type  $\pi - \pi/60$ .
- 4 In the **Upper limit** text field, type  $\pi + \pi/30$ .
- 5 Click to expand the **Smoothing** section. In the **Size of transition zone** text field, type  $\pi/120$ .

### *Integration 1 (intop1)*

- 1 In the **Definitions** toolbar, click  **Nonlocal Couplings** and choose **Integration**.
- 2 Select Domain 2 only.
- 3 In the **Settings** window for **Integration**, locate the **Advanced** section.
- 4 Clear the **Compute integral in revolved geometry** check box.

### *Integration 2 (intop2)*

- 1 In the **Definitions** toolbar, click  **Nonlocal Couplings** and choose **Integration**.
- 2 In the **Settings** window for **Integration**, locate the **Source Selection** section.
- 3 From the **Geometric entity level** list, choose **Boundary**.
- 4 Select Boundaries 4, 5, 15, 18, 19, and 27 only.
- 5 Locate the **Advanced** section. Clear the **Compute integral in revolved geometry** check box.



### *Variables 1*

- 1 In the **Definitions** toolbar, click  **Local Variables**.
- 2 In the **Settings** window for **Variables**, locate the **Variables** section.

3 In the table, enter the following settings:

Name	Expression	Unit	Description
rp	40[mm]	m	Radius of piston
rc	40[mm]	m	Radius of crank
l	200[mm]	m	Length of connecting rod
omega	$(1000 \cdot 2 \cdot \pi / 60)$ [rad/s]	rad/s	Angular velocity of crankshaft
theta	omega*t	rad	Rotation of crankshaft
xp	$-rc \cdot \cos(\theta) + \sqrt{l^2 - (rc \cdot \sin(\theta))^2} + rc - l$	m	Piston displacement
V0	$\text{intop1}(2 \cdot \pi \cdot r)$	m <sup>3</sup>	Initial cylinder volume
V	$V0 - \pi \cdot rp^2 \cdot xp$	m <sup>3</sup>	Current cylinder volume
rho0	1.1886[kg/m <sup>3</sup> ]	kg/m <sup>3</sup>	Air density at STP
m	rho0*V0	kg	Mass of air
R_air	287[J/kg/K]	J/(kg·K)	Specific gas constant of air
Q	600[J]	J	Heat generated during combustion
Pi	$Q \cdot \omega / (\pi [\text{rad}] / 20) \cdot \text{rect1}(\theta)$	W	Power input
Po	$\text{intop2}(p \cdot 2 \cdot \pi \cdot r \cdot d(xp, t) \cdot \text{root.nz})$		Power output

#### ADD MATERIAL





- 1 In the **Home** toolbar, click  **Add Material** to open the **Add Material** window.
- 2 Go to the **Add Material** window.
- 3 In the tree, select **Built-in>Air**.
- 4 Click **Add to Component** in the window toolbar.
- 5 In the **Home** toolbar, click  **Add Material** to close the **Add Material** window.

## MATERIALS

*Air (mat1)*

Use the **Coefficient Form PDE** user interface to model the ideal gas behavior.

### COEFFICIENT FORM PDE (C)

- 1 In the **Model Builder** window, under **Thermodynamic Analysis (comp1)** click **Coefficient Form PDE (c)**.
- 2 Select Domain 2 only.
- 3 In the **Settings** window for **Coefficient Form PDE**, locate the **Units** section.
- 4 Click  **Select Dependent Variable Quantity**.
- 5 In the **Physical Quantity** dialog box, type pressure in the text field.
- 6 Click  **Filter**.
- 7 In the tree, select **General>Pressure (Pa)**.
- 8 Click **OK**.
- 9 In the **Settings** window for **Coefficient Form PDE**, locate the **Units** section.
- 10 Click  **Select Source Term Quantity**.
- 11 In the **Physical Quantity** dialog box, click  **Filter**.
- 12 In the tree, select **General>Pressure (Pa)**.
- 13 Click **OK**.
- 14 In the **Settings** window for **Coefficient Form PDE**, click to expand the **Dependent Variables** section.
- 15 In the **Field name** text field, type p.
- 16 In the **Dependent variables** table, enter the following settings:

p

*Coefficient Form PDE 1*

- 1 In the **Model Builder** window, under **Thermodynamic Analysis (comp1)>Coefficient Form PDE (c)** click **Coefficient Form PDE 1**.
- 2 In the **Settings** window for **Coefficient Form PDE**, locate the **Diffusion Coefficient** section.
- 3 In the  $c$  text field, type 0.
- 4 Locate the **Absorption Coefficient** section. In the  $a$  text field, type 1.
- 5 Locate the **Damping or Mass Coefficient** section. In the  $d_a$  text field, type 0.
- 6 Locate the **Source Term** section. In the  $f$  text field, type  $m/V*R\_air*T$ .



Give the atmospheric pressure as the initial value for the absolute cylinder pressure.

#### *Initial Values 1*

- 1 In the **Model Builder** window, click **Initial Values 1**.
- 2 In the **Settings** window for **Initial Values**, locate the **Initial Values** section.
- 3 In the  $p$  text field, type  $1e5$ .

#### **HEAT TRANSFER IN FLUIDS (HT)**

- 1 In the **Model Builder** window, under **Thermodynamic Analysis (comp1)** click **Heat Transfer in Fluids (ht)**.
- 2 Select Domain 2 only.

#### *Fluid 1*

- 1 In the **Model Builder** window, under **Thermodynamic Analysis (comp1)** > **Heat Transfer in Fluids (ht)** click **Fluid 1**.
- 2 In the **Settings** window for **Fluid**, locate the **Model Input** section.
- 3 From the  $p_A$  list, choose **User defined**. In the associated text field, type  $p$ .

#### *Pressure Work 1*

In the **Physics** toolbar, click  **Attributes** and choose **Pressure Work**.

#### *Heat Source 1*

- 1 In the **Physics** toolbar, click  **Domains** and choose **Heat Source**.
- 2 Select Domain 2 only.
- 3 In the **Settings** window for **Heat Source**, locate the **Heat Source** section.
- 4 In the  $Q_0$  text field, type  $Pi/V$ .

Use a coarser mesh, as in this model the solution does not have a spatial dependence. The mesh is only used to compute the cylinder volume.

#### **MESH 1**

- 1 In the **Model Builder** window, under **Thermodynamic Analysis (comp1)** click **Mesh 1**.
- 2 In the **Settings** window for **Mesh**, locate the **Physics-Controlled Mesh** section.
- 3 From the **Element size** list, choose **Coarser**.
- 4 Click  **Build All**.

#### **STUDY: THERMODYNAMIC ANALYSIS**

- 1 In the **Model Builder** window, click **Study 1**.

- 2 In the **Settings** window for **Study**, type Study: Thermodynamic Analysis in the **Label** text field.

Set the time range to solve for one full revolution of the crankshaft.

#### *Step 1: Time Dependent*

- 1 In the **Model Builder** window, under **Study: Thermodynamic Analysis** click **Step 1: Time Dependent**.
- 2 In the **Settings** window for **Time Dependent**, locate the **Study Settings** section.
- 3 In the **Output times** text field, type range (0,0.0006,0.06).
- 4 In the **Model Builder** window, click **Study: Thermodynamic Analysis**.
- 5 In the **Settings** window for **Study**, locate the **Study Settings** section.
- 6 Clear the **Generate default plots** check box.
- 7 In the **Home** toolbar, click  **Compute**.

## **RESULTS**

Use the following steps to plot the P-V diagram shown in [Figure 3](#).

#### *PV Diagram*

- 1 In the **Home** toolbar, click  **Add Plot Group** and choose **ID Plot Group**.
- 2 In the **Settings** window for **ID Plot Group**, type PV Diagram in the **Label** text field.

#### *Point Graph 1*

- 1 Right-click **PV Diagram** and choose **Point Graph**.
- 2 Select Point 2 only.
- 3 In the **Settings** window for **Point Graph**, locate the **y-Axis Data** section.
- 4 In the **Expression** text field, type p.
- 5 From the **Unit** list, choose **bar**.
- 6 Locate the **x-Axis Data** section. From the **Parameter** list, choose **Expression**.
- 7 In the **Expression** text field, type V.
- 8 From the **Unit** list, choose **ml**.
- 9 Click to expand the **Coloring and Style** section. In the **Width** text field, type 2.
- 10 Click to expand the **Title** section. From the **Title type** list, choose **None**.

#### *PV Diagram*

- 1 In the **Model Builder** window, click **PV Diagram**.
- 2 In the **Settings** window for **ID Plot Group**, locate the **Plot Settings** section.

- 3 Select the **y-axis label** check box.
- 4 In the associated text field, type `Pressure (bar)`.
- 5 Select the **x-axis label** check box.
- 6 In the associated text field, type `Volume (cc)`.
- 7 In the **PV Diagram** toolbar, click  **Plot**.

Follow these steps to plot the cylinder pressure variation with the crankshaft rotation shown in [Figure 4](#).

#### *Cylinder Pressure*

- 1 Right-click **PV Diagram** and choose **Duplicate**.
- 2 In the **Settings** window for **ID Plot Group**, type `Cylinder Pressure` in the **Label** text field.
- 3 Locate the **Plot Settings** section. In the **x-axis label** text field, type `Rotation of crankshaft (rad)`.

#### *Point Graph 1*

- 1 In the **Model Builder** window, expand the **Cylinder Pressure** node, then click **Point Graph 1**.
- 2 In the **Settings** window for **Point Graph**, locate the **x-Axis Data** section.
- 3 In the **Expression** text field, type `theta`.
- 4 In the **Cylinder Pressure** toolbar, click  **Plot**.

Export the cylinder pressure data to use it in the second part of the model.

#### *Plot 1*

- 1 Right-click **Results>Cylinder Pressure>Point Graph 1** and choose **Add Plot Data to Export**.
- 2 In the **Settings** window for **Plot**, locate the **Output** section.
- 3 Click  **Browse**.
- 4 Browse to a suitable folder, enter the filename `reciprocating_engine_pressure.txt`, and then click **Save**.
- 5 Click to expand the **Advanced** section. Clear the **Include header** check box.
- 6 Clear the **Full precision** check box.
- 7 Click the **Export** button to save the file.

Follow these steps to compute the mechanical energy generated per cycle, due to the combustion in one of the cylinders of the engine.

### Global Evaluation 1

- 1 In the **Results** toolbar, click  **Global Evaluation**.
- 2 In the **Settings** window for **Global Evaluation**, locate the **Data** section.
- 3 From the **Time selection** list, choose **Last**.
- 4 Locate the **Expressions** section. In the table, enter the following settings:

Expression	Unit	Description
timeint(0, 0.06, Po)	J	Mechanical Energy

- 5 Click  **Evaluate**.

### TABLE

- 1 Go to the **Table** window.  
The result appears in a table below the **Graphics** window.



## Part 2 — Multibody Analysis

In case you start the modeling here, without having the previous thermodynamics study available, a few instructions need to be modified. An example is that **Component 2** should be replaced by **Component 1**. Such differences should be easy to identify. Since in this case there is only one model and one physics interface, there will be no ambiguities in how to interpret the modeling instructions.

### ADD COMPONENT

In the **Model Builder** window, right-click the root node and choose **Add Component>3D**.

### ADD PHYSICS

- 1 In the **Home** toolbar, click  **Add Physics** to open the **Add Physics** window.
- 2 Go to the **Add Physics** window.
- 3 In the tree, select **Structural Mechanics>Multibody Dynamics (mbd)**.
- 4 Find the **Physics interfaces in study** subsection. In the table, clear the **Solve** check box for **Study: Thermodynamic Analysis**.
- 5 Click **Add to Component 2** in the window toolbar.
- 6 In the **Home** toolbar, click  **Add Physics** to close the **Add Physics** window.

### ADD STUDY

- 1 In the **Home** toolbar, click  **Add Study** to open the **Add Study** window.

- 2 Go to the **Add Study** window.
- 3 Find the **Studies** subsection. In the **Select Study** tree, select **General Studies> Time Dependent**.
- 4 Find the **Physics interfaces in study** subsection. In the table, clear the **Solve** check boxes for **Heat Transfer in Fluids (ht)** and **Coefficient Form PDE (c)**.
- 5 Click **Add Study** in the window toolbar.
- 6 In the **Model Builder** window, click the root node.
- 7 In the **Home** toolbar, click  **Add Study** to close the **Add Study** window.



## MULTIBODY ANALYSIS

In the **Settings** window for **Component**, type **Multibody Analysis** in the **Label** text field.

## GEOMETRY 2

In the **Model Builder** window, under **Multibody Analysis (comp2)** click **Geometry 2**.

### *Import 1 (imp1)*

- 1 In the **Home** toolbar, click  **Import**.
- 2 In the **Settings** window for **Import**, locate the **Import** section.
- 3 Click  **Browse**.
- 4 Browse to the model's Application Libraries folder and double-click the file `reciprocating_engine.mphbin`.
- 5 Click  **Import**.

Make a union of the flywheel and the crankshaft to avoid modeling a fixed joint between them.

### *Union 1 (uni1)*

- 1 In the **Geometry** toolbar, click  **Booleans and Partitions** and choose **Union**.
- 2 Select the objects **imp1(1)** and **imp1(11)** only.
- 3 In the **Settings** window for **Union**, locate the **Union** section.
- 4 Clear the **Keep interior boundaries** check box.

### *Form Union (fin)*

- 1 In the **Model Builder** window, under **Multibody Analysis (comp2)>Geometry 2** click **Form Union (fin)**.
- 2 In the **Settings** window for **Form Union/Assembly**, locate the **Form Union/Assembly** section.
- 3 From the **Action** list, choose **Form an assembly**.

4 Click  **Build Selected**.

For automatic generation of hinge and prismatic joints between different parts, group the identity boundary pairs.

#### **DEFINITIONS (COMP2)**

In the **Model Builder** window, expand the **Multibody Analysis (comp2)>Definitions** node.

*Identity Boundary Pair 1 (ap1), Identity Boundary Pair 2 (ap2), Identity Boundary Pair 3 (ap3), Identity Boundary Pair 4 (ap4), Identity Boundary Pair 6 (ap6), Identity Boundary Pair 8 (ap8)*

1 In the **Model Builder** window, under **Multibody Analysis (comp2)>Definitions**, Ctrl-click to select **Identity Boundary Pair 1 (ap1)**, **Identity Boundary Pair 2 (ap2)**, **Identity Boundary Pair 3 (ap3)**, **Identity Boundary Pair 4 (ap4)**, **Identity Boundary Pair 6 (ap6)**, and **Identity Boundary Pair 8 (ap8)**.

2 Right-click and choose **Group**.

#### *Hinge Joint Pairs*

In the **Settings** window for **Group**, type Hinge Joint Pairs in the **Label** text field.

*Identity Boundary Pair 5 (ap5), Identity Boundary Pair 7 (ap7), Identity Boundary Pair 9 (ap9)*

1 In the **Model Builder** window, under **Multibody Analysis (comp2)>Definitions**, Ctrl-click to select **Identity Boundary Pair 5 (ap5)**, **Identity Boundary Pair 7 (ap7)**, and **Identity Boundary Pair 9 (ap9)**.

2 Right-click and choose **Group**.

#### *Prismatic Joint Pairs*

1 In the **Settings** window for **Group**, type Prismatic Joint Pairs in the **Label** text field.

2 Right-click **Prismatic Joint Pairs** and choose **Disable**.

Import the cylinder pressure data obtained in the thermodynamic analysis.

#### *Interpolation 1 (int1)*

1 In the **Home** toolbar, click  **Functions** and choose **Local>Interpolation**.

2 In the **Settings** window for **Interpolation**, locate the **Definition** section.

3 Click  **Load from File**.

4 Browse to the model's Application Libraries folder and double-click the file `reciprocating_engine_pressure.txt`.

5 In the **Function name** text field, type p.

6 Locate the **Units** section. In the **Argument** table, enter the following settings:

Argument	Unit
t	rad

7 In the **Function** table, enter the following settings:

Function	Unit
p	bar

Create selections for the top boundaries of each piston, so that the cylinder pressure can be applied.

#### *Cylinder 1*

- 1 In the **Definitions** toolbar, click  **Cylinder**.
- 2 In the **Settings** window for **Cylinder**, locate the **Geometric Entity Level** section.
- 3 From the **Level** list, choose **Boundary**.
- 4 Locate the **Size and Shape** section. In the **Outer radius** text field, type 0.03.
- 5 In the **Bottom distance** text field, type -0.081.
- 6 Locate the **Position** section. In the **x** text field, type -0.11.

#### *Cylinder 2*

- 1 Right-click **Cylinder 1** and choose **Duplicate**.
- 2 In the **Settings** window for **Cylinder**, locate the **Size and Shape** section.
- 3 In the **Bottom distance** text field, type -0.013.
- 4 Locate the **Position** section. In the **x** text field, type 0.

#### *Cylinder 3*

- 1 Right-click **Cylinder 2** and choose **Duplicate**.
- 2 In the **Settings** window for **Cylinder**, locate the **Size and Shape** section.
- 3 In the **Bottom distance** text field, type -0.07.
- 4 Locate the **Position** section. In the **x** text field, type 0.11.



For automatically creating **Rigid Domain** nodes in Multibody Dynamics interface, create a selection of all rigid components. This includes all domains except the second connecting rod, which is the only flexible component of the system.

#### *Rigid Domains*

- 1 In the **Definitions** toolbar, click  **Explicit**.

- 2 Click in the **Graphics** window and then press Ctrl+A to select all domains.
- 3 Select Domains 1–5 and 7–10 only.
- 4 In the **Settings** window for **Explicit**, type Rigid Domains in the **Label** text field.

#### ADD MATERIAL

- 1 In the **Home** toolbar, click  **Add Material** to open the **Add Material** window.
- 2 Go to the **Add Material** window.
- 3 In the tree, select **Built-in>Structural steel**.
- 4 Click **Add to Component** in the window toolbar.
- 5 In the **Home** toolbar, click  **Add Material** to close the **Add Material** window.

The second connecting rod is the only flexible component and is defined using the default **Linear Elastic Material** model. **Rigid Domain** nodes on all rigid components of engine can be created automatically from **Automated Model Setup** section of Multibody Dynamics node.

#### MULTIBODY DYNAMICS (MBD)

- 1 In the **Model Builder** window, under **Multibody Analysis (comp2)** click **Multibody Dynamics (mbd)**.
- 2 In the **Settings** window for **Multibody Dynamics**, locate the **Automated Model Setup** section.
- 3 From the **Rigid domains selection** list, choose **Rigid Domains**.
- 4 Click **Physics Node Generation** in the upper-right corner of the **Automated Model Setup** section. From the menu, choose **Create Rigid Domains**.

#### *Crankshaft*

- 1 In the **Model Builder** window, expand the **Rigid Domains (sel1)** node, then click **Rigid Domain 1**.
- 2 In the **Settings** window for **Rigid Domain**, type Crankshaft in the **Label** text field.

#### *Reciprocating Engine Components*

You can rename other rigid domains in the group with the ones given in the table below:

Rigid Domain	Name
Rigid Domain 2	Piston 1
Rigid Domain 3	Connecting rod 1
Rigid Domain 4	Cylinder 1
Rigid Domain 5	Piston 2



Rigid Domain	Name
Rigid Domain 6	Cylinder 2
Rigid Domain 7	Piston 3
Rigid Domain 8	Connecting rod 3
Rigid Domain 9	Cylinder 3

#### *Cylinder 1*

In the **Model Builder** window, click **Cylinder 1**.

#### *Fixed Constraint 1*

In the **Physics** toolbar, click  **Attributes** and choose **Fixed Constraint**.

#### *Cylinder 2*

In the **Model Builder** window, under **Multibody Analysis (comp2)>Multibody Dynamics (mbd)>Rigid Domains (sel1)** click **Cylinder 2**.

#### *Fixed Constraint 1*

In the **Physics** toolbar, click  **Attributes** and choose **Fixed Constraint**.

#### *Cylinder 3*

In the **Model Builder** window, under **Multibody Analysis (comp2)>Multibody Dynamics (mbd)>Rigid Domains (sel1)** click **Cylinder 3**.

#### *Fixed Constraint 1*

In the **Physics** toolbar, click  **Attributes** and choose **Fixed Constraint**.

Use **Create Joints** button for automatically creating **Attachment** nodes and **Hinge Joint** nodes from Multibody Dynamics Physics.

#### *Hinge Joints*

1 The details of **Hinge Joint** nodes between different components of engine are given in the table below:

Name	Source	Destination
Hinge Joint 1	Crankshaft	Connecting rod 1
Hinge Joint 2	Crankshaft	Connecting rod 2: bottom end
Hinge Joint 3	Crankshaft	Connecting rod 3
Hinge Joint 4	Piston 1	Connecting rod 1
Hinge Joint 5	Piston 2	Connecting rod 2: top end
Hinge Joint 6	Piston 3	Connecting rod 3

Name	Source	Destination
Hinge Joint 7	Fixed	Crankshaft
Hinge Joint 8	Fixed	Crankshaft

- 2 In the **Model Builder** window, click **Multibody Dynamics (mbd)**.
- 3 In the **Settings** window for **Multibody Dynamics**, locate the **Automated Model Setup** section.
- 4 Find the **Joint types** subsection. From the **Planar boundaries** list, choose **None**.
- 5 From the **Spherical boundaries** list, choose **None**.
- 6 Click **Physics Node Generation** in the upper-right corner of the **Automated Model Setup** section. From the menu, choose **Create Joints**.

#### *Connecting Rod 2: Bottom End*

- 1 In the **Model Builder** window, expand the **Hinge Joints** node, then click **Attachment 1**.
- 2 In the **Settings** window for **Attachment**, type Connecting Rod 2: Bottom End in the **Label** text field.
- 3 Locate the **Connection Type** section. From the list, choose **Flexible**.

#### *Connecting Rod 2: Top End*

- 1 In the **Model Builder** window, under **Multibody Analysis (comp2)> Multibody Dynamics (mbd)>Hinge Joints** click **Attachment 2**.
- 2 In the **Settings** window for **Attachment**, type Connecting Rod 2: Top End in the **Label** text field.
- 3 Locate the **Connection Type** section. From the list, choose **Flexible**.

#### *Hinge Joint 7*

- 1 In the **Model Builder** window, under **Multibody Analysis (comp2)> Multibody Dynamics (mbd)>Hinge Joints** right-click **Hinge Joint 6** and choose **Duplicate**.
- 2 In the **Settings** window for **Hinge Joint**, locate the **Attachment Selection** section.
- 3 From the **Source** list, choose **Fixed**.
- 4 From the **Destination** list, choose **Crankshaft**.
- 5 Locate the **Center of Joint** section. From the list, choose **Centroid of selected entities**.
- 6 From the **Entity level** list, choose **Edge**.

#### *Center of Joint: Edge 1*

- 1 In the **Model Builder** window, click **Center of Joint: Edge 1**.
- 2 Select Edges 21 and 24 only.

### *Hinge Joint 8*

In the **Model Builder** window, under **Multibody Analysis (comp2)**>

**Multibody Dynamics (mbd)**>**Hinge Joints** right-click **Hinge Joint 7** and choose **Duplicate**.

### *Center of Joint: Edge 1*

- 1 In the **Model Builder** window, expand the **Hinge Joint 8** node, then click **Center of Joint: Edge 1**.
- 2 Select Edges 297 and 298 only.

For automatically creating **Prismatic Joint** nodes between cylindrical boundaries, use **Prismatic Joint Pairs**.

## **DEFINITIONS (COMP2)**

### *Hinge Joint Pairs*

In the **Model Builder** window, under **Multibody Analysis (comp2)**>**Definitions** right-click **Hinge Joint Pairs** and choose **Disable**.

### *Prismatic Joint Pairs*

In the **Model Builder** window, right-click **Prismatic Joint Pairs** and choose **Enable**.

## **MULTIBODY DYNAMICS (MBD)**

- 1 In the **Model Builder** window, under **Multibody Analysis (comp2)** click **Multibody Dynamics (mbd)**.
- 2 In the **Settings** window for **Multibody Dynamics**, locate the **Automated Model Setup** section.
- 3 Find the **Joint types** subsection. From the **Cylindrical boundaries** list, choose **Prismatic joint**.
- 4 Click **Physics Node Generation** in the upper-right corner of the **Automated Model Setup** section. From the menu, choose **Create Joints**.

## **DEFINITIONS (COMP2)**

### *Integration 3 (intop3)*

- 1 In the **Definitions** toolbar, click  **Nonlocal Couplings** and choose **Integration**.
- 2 In the **Settings** window for **Integration**, locate the **Source Selection** section.
- 3 From the **Geometric entity level** list, choose **Boundary**.
- 4 From the **Selection** list, choose **Cylinder 1**.
- 5 Locate the **Advanced** section. From the **Frame** list, choose **Material (X, Y, Z)**.

Use step functions for smooth application of starting torque and external load.

#### Step 1 (step1)

- 1 In the **Definitions** toolbar, click  **More Functions** and choose **Step**.
- 2 In the **Settings** window for **Step**, locate the **Parameters** section.
- 3 In the **Location** text field, type  $\pi/3$ .
- 4 In the **From** text field, type 1.
- 5 In the **To** text field, type 0.
- 6 Click to expand the **Smoothing** section. In the **Size of transition zone** text field, type  $\pi/36$ .

#### Step 2 (step2)

- 1 In the **Definitions** toolbar, click  **More Functions** and choose **Step**.
- 2 In the **Settings** window for **Step**, locate the **Parameters** section.
- 3 In the **Location** text field, type  $3\pi$ .
- 4 Locate the **Smoothing** section. In the **Size of transition zone** text field, type  $\pi/18$ .

Create a maximum operator to compute the maximum stress in the connecting rod.

#### Maximum 1 (maxop1)

- 1 In the **Definitions** toolbar, click  **Nonlocal Couplings** and choose **Maximum**.
- 2 Select Domain 6 only.

#### Variables 2

- 1 In the **Definitions** toolbar, click  **Local Variables**.
- 2 In the **Settings** window for **Variables**, locate the **Variables** section.
- 3 In the table, enter the following settings:

Name	Expression	Unit	Description
theta	abs(mbd.hgj7.th)	rad	Rotation of crankshaft
theta0	50.25[deg]	rad	Initial rotation of crank 1
N	d(theta,t)*60/(2*pi)	rad/s	RPM of crankshaft
Ti	400[N*m]* step1(theta)	N·m	Starting torque
To	0.5[N*m*s/rad]* d(theta,t)* step2(theta)	N·m	Output torque

Name	Expression	Unit	Description
p1	$p(\text{mod}(\text{theta}-\text{theta0}, 2*\pi))$	Pa	Pressure in cylinder 1
p2	$p(\text{mod}(\text{theta}-\text{theta0}+ 4*\pi/3, 2*\pi))$	Pa	Pressure in cylinder 2
p3	$p(\text{mod}(\text{theta}-\text{theta0}+ 2*\pi/3, 2*\pi))$	Pa	Pressure in cylinder 3
A	$\text{intop3}(\text{root.nZ})$	m <sup>2</sup>	Projected area of piston
P1	$-p1*A*\text{mbd.prj1.u}_t/746[\text{W}]$		Power generated in cylinder 1 (hp)
P2	$-p2*A*\text{mbd.prj2.u}_t/746[\text{W}]$		Power generated in cylinder 2 (hp)
P3	$-p3*A*\text{mbd.prj3.u}_t/746[\text{W}]$		Power generated in cylinder 3 (hp)
BHP	$\text{To*d}(\text{theta}, t)/746[\text{W}]$	rad	Brake horse power
MaxStress_cr	$\text{maxop1}(\text{mbd.mises})$	N/m <sup>2</sup>	Maximum stress in connecting rod

Use the **Applied Moment** subnode to apply the starting torque and the external load on the crankshaft.

## MULTIBODY DYNAMICS (MBD)

### Crankshaft

In the **Model Builder** window, under **Multibody Analysis (comp2)> Multibody Dynamics (mbd)>Rigid Domains (sel1)** click **Crankshaft**.

### Applied Moment 1

- 1 In the **Physics** toolbar, click  **Attributes** and choose **Applied Moment**.
- 2 In the **Settings** window for **Applied Moment**, locate the **Applied Moment** section.
- 3 Specify the **M** vector as

Ti	x
0	y
0	z

### Applied Moment 2

- 1 Right-click **Applied Moment 1** and choose **Duplicate**.
- 2 In the **Settings** window for **Applied Moment**, locate the **Applied Moment** section.

3 Specify the **M** vector as

-To	x
0	y
0	z

#### *Boundary Load 1*

- 1 In the **Physics** toolbar, click  **Boundaries** and choose **Boundary Load**.
- 2 In the **Settings** window for **Boundary Load**, locate the **Boundary Selection** section.
- 3 From the **Selection** list, choose **Cylinder 1**.
- 4 Locate the **Force** section. From the **Load type** list, choose **Pressure**.
- 5 In the  $p$  text field, type  $p1$ .

#### *Boundary Load 2*

- 1 In the **Physics** toolbar, click  **Boundaries** and choose **Boundary Load**.
- 2 In the **Settings** window for **Boundary Load**, locate the **Boundary Selection** section.
- 3 From the **Selection** list, choose **Cylinder 2**.
- 4 Locate the **Force** section. From the **Load type** list, choose **Pressure**.
- 5 In the  $p$  text field, type  $p2$ .

#### *Boundary Load 3*

- 1 In the **Physics** toolbar, click  **Boundaries** and choose **Boundary Load**.
- 2 In the **Settings** window for **Boundary Load**, locate the **Boundary Selection** section.
- 3 From the **Selection** list, choose **Cylinder 3**.
- 4 Locate the **Force** section. From the **Load type** list, choose **Pressure**.
- 5 In the  $p$  text field, type  $p3$ .



### **STUDY: MULTIBODY ANALYSIS**

- 1 In the **Model Builder** window, click **Study 2**.
- 2 In the **Settings** window for **Study**, type Study: Multibody Analysis in the **Label** text field.

#### *Step 1: Time Dependent*

- 1 In the **Model Builder** window, under **Study: Multibody Analysis** click **Step 1: Time Dependent**.
- 2 In the **Settings** window for **Time Dependent**, locate the **Study Settings** section.
- 3 In the **Output times** text field, type range(0, 4e-4, 0.16).

### *Solution 2 (sol2)*

- 1 In the **Study** toolbar, click  **Show Default Solver**.
- 2 In the **Model Builder** window, expand the **Solution 2 (sol2)** node.
- 3 In the **Model Builder** window, expand the **Study: Multibody Analysis> Solver Configurations>Solution 2 (sol2)>Dependent Variables 1** node, then click **comp2.mbd.att1.Fc1x**.
- 4 In the **Settings** window for **State**, locate the **Scaling** section.
- 5 In the **Scale** text field, type  $1e8*(0.1*0.7011179332388733)^2*100$ .
- 6 In the **Model Builder** window, under **Study: Multibody Analysis>Solver Configurations>Solution 2 (sol2)>Dependent Variables 1** click **comp2.mbd.att1.Fd1x**.
- 7 In the **Settings** window for **State**, locate the **Scaling** section.
- 8 In the **Scale** text field, type  $1e8*(0.1*0.7011179332388733)*100$ .
- 9 In the **Model Builder** window, under **Study: Multibody Analysis>Solver Configurations>Solution 2 (sol2)>Dependent Variables 1** click **comp2.mbd.att2.Fc1x**.
- 10 In the **Settings** window for **State**, locate the **Scaling** section.
- 11 In the **Scale** text field, type  $1e8*(0.1*0.7011179332388733)^2*100$ .
- 12 In the **Model Builder** window, under **Study: Multibody Analysis>Solver Configurations>Solution 2 (sol2)>Dependent Variables 1** click **comp2.mbd.att2.Fd1x**.
- 13 In the **Settings** window for **State**, locate the **Scaling** section.
- 14 In the **Scale** text field, type  $1e8*(0.1*0.7011179332388733)*100$ .
- 15 In the **Model Builder** window, under **Study: Multibody Analysis>Solver Configurations>Solution 2 (sol2)** click **Time-Dependent Solver 1**.
- 16 In the **Settings** window for **Time-Dependent Solver**, click to expand the **Time Stepping** section.
- 17 From the **Steps taken by solver** list, choose **Free**.
- 18 From the **Maximum step constraint** list, choose **Constant**.
- 19 In the **Maximum step** text field, type  $4e-4$ .
- 20 In the **Study** toolbar, click  **Compute**.

## **RESULTS**

### *Displacement (mbd)*

The numbering of the datasets and plots may differ from the instructions given below, if you started by directly modeling the multibody analysis.

Follow these instructions to generate the displacement plot shown in [Figure 5](#).

*Study: Multibody Analysis/Solution 2 (4) (sol2)*

- 1 In the **Model Builder** window, expand the **Results>Datasets** node.
- 2 Right-click **Results>Datasets>Study: Multibody Analysis/Solution 2 (3) (sol2)** and choose **Duplicate**.

*Selection*

- 1 In the **Model Builder** window, right-click **Study: Multibody Analysis/Solution 2 (4) (sol2)** and choose **Selection**.
- 2 In the **Settings** window for **Selection**, locate the **Geometric Entity Selection** section.
- 3 From the **Geometric entity level** list, choose **Domain**.
- 4 Select Domains 1–3, 5, 6, 8, and 9 only.

*Surface*

- 1 In the **Model Builder** window, expand the **Results>Displacement (mbd)** node, then click **Surface**.
- 2 In the **Settings** window for **Surface**, locate the **Data** section.
- 3 From the **Dataset** list, choose **Study: Multibody Analysis/Solution 2 (4) (sol2)**.
- 4 From the **Solution parameters** list, choose **From parent**.
- 5 Locate the **Expression** section. From the **Unit** list, choose **mm**.

*Volume 1*

- 1 In the **Model Builder** window, right-click **Displacement (mbd)** and choose **Volume**.
- 2 In the **Settings** window for **Volume**, click to expand the **Title** section.
- 3 From the **Title type** list, choose **None**.
- 4 Locate the **Coloring and Style** section. From the **Coloring** list, choose **Uniform**.
- 5 From the **Color** list, choose **Gray**.

*Selection 1*

- 1 In the **Model Builder** window, right-click **Volume 1** and choose **Selection**.
- 2 Select Domains 4, 7, and 10 only.
- 3 In the **Displacement (mbd)** toolbar, click  **Plot**.

*Transparency 1*

- In the **Model Builder** window, right-click **Volume 1** and choose **Transparency**.



### *Applied Loads (mbd)*

In the **Model Builder** window, expand the **Results>Applied Loads (mbd)** node.

### *Boundary Loads (mbd)*

In the **Model Builder** window, expand the **Results>Applied Loads (mbd)>Boundary Loads (mbd)** node.

### *Boundary Load 1, Boundary Load 2, Boundary Load 3*

- 1 In the **Model Builder** window, under **Results>Applied Loads (mbd)>Boundary Loads (mbd)**, Ctrl-click to select **Boundary Load 1**, **Boundary Load 2**, and **Boundary Load 3**.
- 2 Right-click and choose **Copy**.

### *Boundary Load 1*

In the **Model Builder** window, right-click **Displacement (mbd)** and choose **Paste Multiple Items**.



### *Color Expression*

- 1 In the **Model Builder** window, expand the **Boundary Load 1** node, then click **Color Expression**.
- 2 In the **Settings** window for **Color Expression**, locate the **Coloring and Style** section.
- 3 Clear the **Color legend** check box.

### *Boundary Load 2*

- 1 In the **Model Builder** window, under **Results>Displacement (mbd)** click **Boundary Load 2**.
- 2 In the **Settings** window for **Arrow Surface**, click to expand the **Title** section.
- 3 From the **Title type** list, choose **None**.

### *Boundary Load 3*

- 1 In the **Model Builder** window, click **Boundary Load 3**.
- 2 In the **Settings** window for **Arrow Surface**, locate the **Title** section.
- 3 From the **Title type** list, choose **None**.
- 4 Click the  **Zoom Extents** button in the **Graphics** toolbar.
- 5 In the **Displacement (mbd)** toolbar, click  **Plot**.

Use the following instructions to plot the von-Mises stress in the second connecting rod as shown in [Figure 6](#).

### *Study: Multibody Analysis/Solution 2 (5) (sol2)*

In the **Model Builder** window, under **Results>Datasets** right-click **Study: Multibody Analysis/Solution 2 (3) (sol2)** and choose **Duplicate**.

### Selection

- 1 In the **Results** toolbar, click  **Attributes** and choose **Selection**.
- 2 In the **Settings** window for **Selection**, locate the **Geometric Entity Selection** section.
- 3 From the **Geometric entity level** list, choose **Domain**.
- 4 Select Domain 6 only.



### Stress: Connecting Rod

- 1 In the **Results** toolbar, click  **3D Plot Group**.
- 2 In the **Settings** window for **3D Plot Group**, type Stress: Connecting Rod in the **Label** text field.
- 3 Locate the **Data** section. From the **Dataset** list, choose **Study: Multibody Analysis/Solution 2 (5) (sol2)**.

### Surface 1

- 1 Right-click **Stress: Connecting Rod** and choose **Surface**.
- 2 In the **Settings** window for **Surface**, click **Replace Expression** in the upper-right corner of the **Expression** section. From the menu, choose **Multibody Analysis (comp2)>Multibody Dynamics>Stress>mbd.mises - von Mises stress - N/m<sup>2</sup>**.

### Stress: Connecting Rod

- 1 In the **Model Builder** window, click **Stress: Connecting Rod**.
- 2 In the **Settings** window for **3D Plot Group**, locate the **Plot Settings** section.
- 3 Clear the **Plot dataset edges** check box.
- 4 Click the  **Zoom Extents** button in the **Graphics** toolbar.
- 5 In the **Stress: Connecting Rod** toolbar, click  **Plot**.

Follow these instructions to reproduce the RPM versus crank rotation curve shown in [Figure 7](#).

### RPM

- 1 In the **Home** toolbar, click  **Add Plot Group** and choose **ID Plot Group**.
- 2 In the **Settings** window for **ID Plot Group**, type RPM in the **Label** text field.
- 3 Locate the **Data** section. From the **Dataset** list, choose **Study: Multibody Analysis/Solution 2 (3) (sol2)**.

### Global 1

- 1 Right-click **RPM** and choose **Global**.

- 2 In the **Settings** window for **Global**, click **Replace Expression** in the upper-right corner of the **y-Axis Data** section. From the menu, choose **Multibody Analysis (comp2)>Definitions>Variables>N - RPM of crankshaft - rad/s**.
- 3 Click to expand the **Legends** section. Clear the **Show legends** check box.
- 4 Locate the **x-Axis Data** section. From the **Parameter** list, choose **Expression**.
- 5 In the **Expression** text field, type  $\text{theta}/(2*\text{pi})$ .
- 6 Click to expand the **Coloring and Style** section. In the **Width** text field, type 2.
- 7 Click to expand the **Title** section. From the **Title type** list, choose **None**.

#### *RPM*

- 1 In the **Model Builder** window, click **RPM**.
- 2 In the **Settings** window for **ID Plot Group**, locate the **Plot Settings** section.
- 3 Select the **x-axis label** check box.
- 4 In the associated text field, type **Rotation of crankshaft (cycle)**.
- 5 Select the **y-axis label** check box.
- 6 In the associated text field, type **RPM of crankshaft**.
- 7 In the **RPM** toolbar, click  **Plot**.

Follow the instructions below to plot the mechanical power generated in each cylinder. The resulting plot should look like the one shown in [Figure 8](#).

#### *Power Generated*

- 1 Right-click **RPM** and choose **Duplicate**.
- 2 In the **Settings** window for **ID Plot Group**, type **Power Generated** in the **Label** text field.
- 3 Locate the **Plot Settings** section. In the **y-axis label** text field, type **Power generated (hp)**.

#### *Global 1*

- 1 In the **Model Builder** window, expand the **Power Generated** node, then click **Global 1**.
- 2 In the **Settings** window for **Global**, click **Replace Expression** in the upper-right corner of the **y-Axis Data** section. From the menu, choose **Multibody Analysis (comp2)>Definitions>Variables>P1 - Power generated in cylinder 1 (hp)**.
- 3 Click **Add Expression** in the upper-right corner of the **y-Axis Data** section. From the menu, choose **Multibody Analysis (comp2)>Definitions>Variables>P2 - Power generated in cylinder 2 (hp)**.

- 4 Click **Add Expression** in the upper-right corner of the **y-Axis Data** section. From the menu, choose **Multibody Analysis (comp2)>Definitions>Variables>P3 - Power generated in cylinder 3 (hp)**.
- 5 Locate the **Coloring and Style** section. Find the **Line markers** subsection. From the **Marker** list, choose **Cycle**.
- 6 In the **Number** text field, type 30.
- 7 Locate the **Legends** section. Select the **Show legends** check box.
- 8 In the **Power Generated** toolbar, click  **Plot**.

#### *Power Generated*

- 1 In the **Model Builder** window, click **Power Generated**.
- 2 In the **Settings** window for **ID Plot Group**, locate the **Axis** section.
- 3 Select the **Manual axis limits** check box.
- 4 In the **y maximum** text field, type 200.
- 5 In the **Power Generated** toolbar, click  **Plot**.

Use the following instructions to plot the brake horse power of the engine. The resulting plot should look like the one shown in [Figure 9](#).

#### *Brake Horse Power*

- 1 In the **Model Builder** window, right-click **RPM** and choose **Duplicate**.
- 2 In the **Settings** window for **ID Plot Group**, type Brake Horse Power in the **Label** text field.
- 3 Locate the **Plot Settings** section. In the **y-axis label** text field, type BHP.

#### *Global 1*

- 1 In the **Model Builder** window, expand the **Brake Horse Power** node, then click **Global 1**.
- 2 In the **Settings** window for **Global**, click **Replace Expression** in the upper-right corner of the **y-Axis Data** section. From the menu, choose **Multibody Analysis (comp2)>Definitions>Variables>BHP - Brake horse power - rad**.
- 3 In the **Brake Horse Power** toolbar, click  **Plot**.

Use the following instructions to reproduce the variation of the maximum stress generated in the second connecting rod shown in [Figure 10](#).

#### *Max Stress: Connecting Rod*

- 1 In the **Model Builder** window, right-click **RPM** and choose **Duplicate**.

- 2 In the **Settings** window for **ID Plot Group**, type Max Stress: Connecting Rod in the **Label** text field.
- 3 Locate the **Plot Settings** section. In the **y-axis label** text field, type von Mises stress (MPa).

*Global 1*

- 1 In the **Model Builder** window, expand the **Max Stress: Connecting Rod** node, then click **Global 1**.
- 2 In the **Settings** window for **Global**, click **Replace Expression** in the upper-right corner of the **y-Axis Data** section. From the menu, choose **Multibody Analysis (comp2)>Definitions>Variables>MaxStress\_cr - Maximum stress in connecting rod - N/m<sup>2</sup>**.
- 3 Locate the **y-Axis Data** section. In the table, enter the following settings:

Expression	Unit	Description
MaxStress_cr	MPa	Maximum stress in connecting rod

- 4 Locate the **Title** section. From the **Title type** list, choose **Manual**.
- 5 In the **Title** text area, type Maximum stress in connecting rod.
- 6 In the **Max Stress: Connecting Rod** toolbar, click  **Plot**.

Use the following instructions to plot the forces in the joint between the second connecting rod and the crankpin. The resulting plot should look like the one shown in [Figure 11](#).

*Joint Force: Connecting Rod-Crank*

- 1 In the **Model Builder** window, right-click **Power Generated** and choose **Duplicate**.
- 2 In the **Settings** window for **ID Plot Group**, type Joint Force: Connecting Rod-Crank in the **Label** text field.
- 3 Locate the **Plot Settings** section. In the **y-axis label** text field, type Joint force (N).

*Global 1*

- 1 In the **Model Builder** window, expand the **Joint Force: Connecting Rod-Crank** node, then click **Global 1**.
- 2 In the **Settings** window for **Global**, click **Replace Expression** in the upper-right corner of the **y-Axis Data** section. From the menu, choose **Multibody Analysis (comp2)>Multibody Dynamics>Hinge joints>Hinge Joint 2>Joint force - N>mbd.hgj2.Fx - Joint force, x component**.



- 3 Click **Add Expression** in the upper-right corner of the **y-Axis Data** section. From the menu, choose **Multibody Analysis (comp2)>Multibody Dynamics>Hinge joints>Hinge Joint 2>Joint force - N>mbd.hgj2.Fy - Joint force, y component**.
- 4 Click **Add Expression** in the upper-right corner of the **y-Axis Data** section. From the menu, choose **Multibody Analysis (comp2)>Multibody Dynamics>Hinge joints>Hinge Joint 2>Joint force - N>mbd.hgj2.Fz - Joint force, z component**.
- 5 In the **Joint Force: Connecting Rod-Crank** toolbar, click  **Plot**.

#### *Joint Force: Connecting Rod-Crank*

- 1 In the **Model Builder** window, click **Joint Force: Connecting Rod-Crank**.
- 2 In the **Settings** window for **ID Plot Group**, locate the **Axis** section.
- 3 In the **y minimum** text field, type -5000.
- 4 In the **y maximum** text field, type 35000.
- 5 In the **Joint Force: Connecting Rod-Crank** toolbar, click  **Plot**.

Use the following instructions to generate an animation of the motion of the different components of the engine.

#### *Animation 1*

- 1 In the **Results** toolbar, click  **Animation** and choose **Player**.
- 2 In the **Settings** window for **Animation**, locate the **Scene** section.
- 3 From the **Subject** list, choose **Displacement (mbd)**.
- 4 Locate the **Frames** section. In the **Number of frames** text field, type 100.
- 5 Click the  **Play** button in the **Graphics** toolbar.

The analyses are now finished. If you open a saved model and want to recompute the solution, then **Study: Multibody analysis** can be re-computed without making any changes. To run the **Study: Thermodynamic analysis**, you need to enable the **Pressure Work** node by right clicking on **Component 1 > Heat Transfer in Fluids > Fluid > Pressure Work** and then clicking **Enable**.