

Polymer Electrolyte Membrane Electrolyzer

Introduction

In a polymer electrolyte membrane electrolyzer cell (PEMEC), the two electrode compartments are separated by a polymer membrane, coated by porous gas diffusion electrodes. Liquid water is fed to the anode side, forming oxygen gas on the anode side and hydrogen gas on the cathode side.

The respective designs of the flow field patterns are important in order to obtain a uniform distribution of flow, in combination with low pressure drops, during operation.

In this example, the mixture model is used to model the two-phase fluid dynamics on the anode side of a PEMEC.

The model geometry and operating condition were taken from [Ref. 1](#), with added gravity and zero tangential (no slip) conditions for all channel walls. The single-phase results for a 60 ml/min flow rate were verified versus [Ref. 2](#).

Model Definition

[Figure 1](#) shows the model geometry. From the circular inlet (located at the top boundary of the cylinder), liquid water is led into a manifold, which in turn distributes the flow over 23 channels. Oxygen gas is produced at the anode electrode, located below the

23 channels. The two-phase oxygen gas/liquid water mixture exits the cell through the exit manifold.

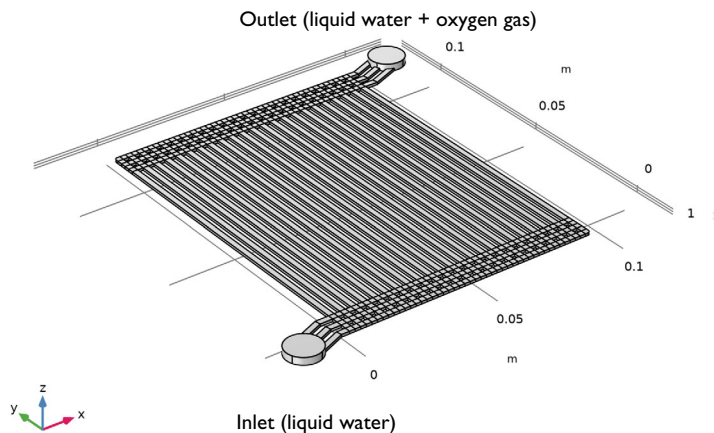
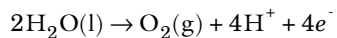

Figure 1: Geometry of the anode flow field.

The model is set up using the Mixture Model, Laminar Flow interface, with liquid water defining the continuous phase and the oxygen gas bubbles the dispersed phase. Incompressible and isothermal conditions are assumed.

The inlet flow rate of liquid water is 260 ml/min. This is defined using an Inlet boundary condition.

At the electrode surface/channel boundaries liquid water is consumed, and oxygen gas is produced according to



The protons are transported through the polymer membrane, dividing the two electrode compartments, over to the cathode side of the electrolyzer cell. In addition to the oxygen gas produced, there is hence a net mass outflux due to the proton transport at the electrode surface/channel boundaries.

The combined oxygen gas production/total mass outflux is defined using an Inlet boundary condition node, assuming a total oxygen production of 5 mg/s.

A pressure condition is used at the outlet boundaries. No-slip wall conditions are set for all other boundaries.

Finally, the buoyancy effects due to gravity are included in the model using a Gravity node, with the gravity vector pointing downward in the z direction.

The model is solved in two steps. First the single-phase (pure liquid water, no oxygen production) stationary flow is computed using a stationary solver. This solution is then used as initial conditions for a 10 s time-dependent simulation, where the oxygen production is ramped up to full production from 0 during the first second.

Results and Discussion

Figure 2 shows a slice plot of the mass-averaged velocity magnitude.

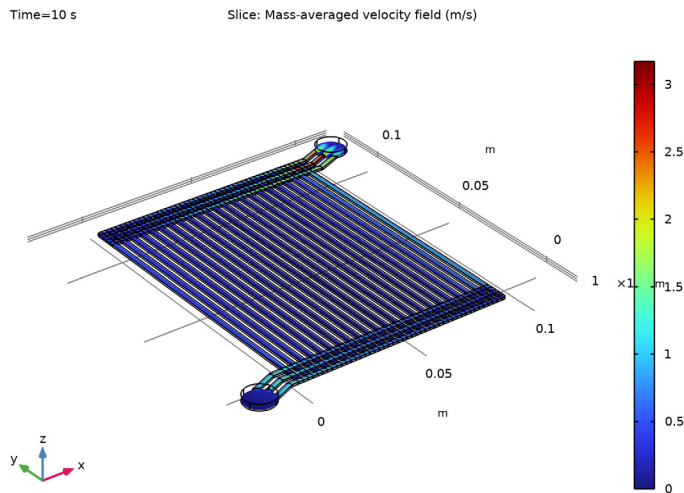

Figure 2: Slice plot of the velocity magnitude at $t = 10$ s.

The highest velocities are found in the inlet/outlet manifold channels. A good practice when assuming laminar flow is to check the Reynolds number of the computed results.

The Reynolds number Re is defined as

$$Re = \frac{\rho u D}{\mu}$$

where ρ is the density, u the velocity, μ the dynamic viscosity and D the characteristic length.

Given that the width of the channels, 2 mm, is larger than the height, 0.889 mm, we choose the doubled height (an approximation valid for a wide duct) as the characteristic length D . At the inlet, where we have pure water and the density-to-dynamic viscosity is the highest, the maximum velocity is about 1.3 m/s.

The Reynolds number for the inlet manifold channels becomes (all parameter values using the corresponding SI units)

$$\text{Re} = \frac{\rho u D}{\mu} \approx \frac{10^3 \times 1.3 \times (2 \times 0.889 \times 10^{-3})}{10^{-3}} \approx 2300$$

A similar calculation for the outlet renders lower values. Reynolds numbers in the range of 2300 and lower, indicates that turbulence should not have to be considered for the given geometry and flow rates.

Figure 3 shows the gas volume fraction due to evolved oxygen in the cell at 10 s.

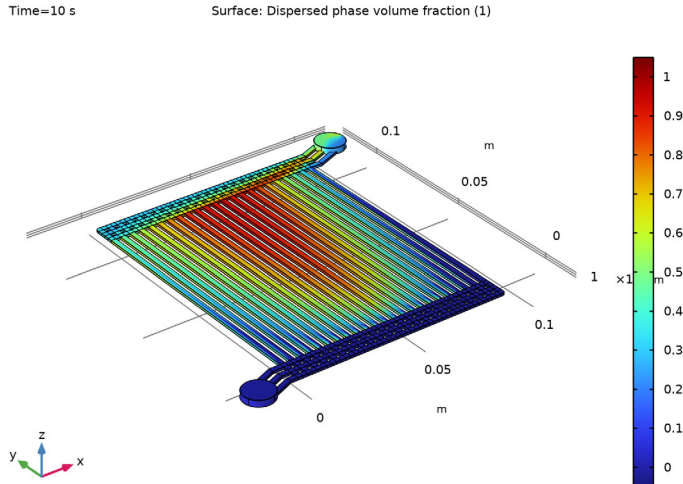

Figure 3: Gas volume fraction in the cell at $t = 10$ s.

The gas volume fraction approaches 100% at the end of the electrode flow channels located at the middle of the flow field.

Figure 4 and Figure 5 show the pressure drop in the anode flow field at $t = 0$ and $t = 10$ s, respectively. The pressure drop over the whole flow field increases slightly as a result of the oxygen gas evolution.

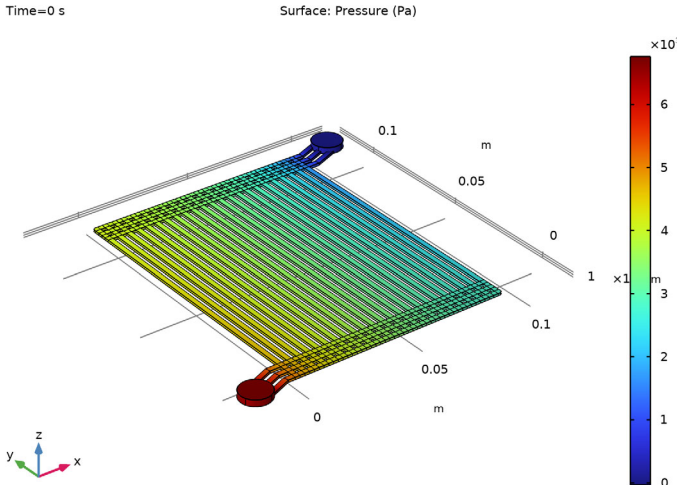

Figure 4: Pressure drop in the cell at $t = 0$ s.

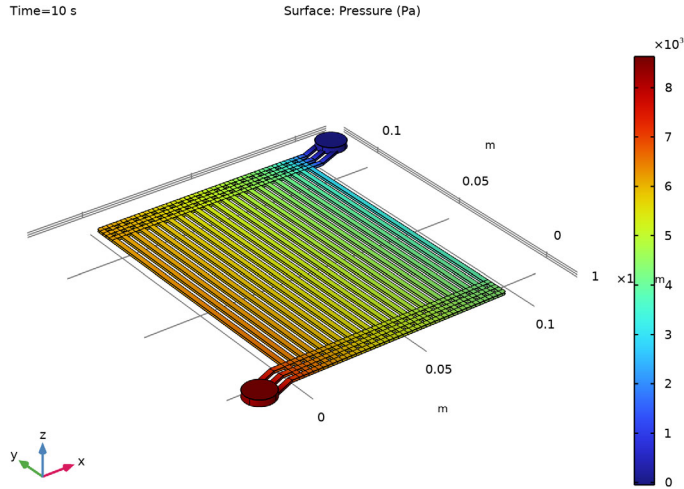

Figure 5: Pressure drop in the cell at $t = 10$ s.

Finally, [Figure 6](#) shows the velocity magnitudes at half the length (y direction) and half in the height (z direction) of the electrode channels at various times. This plot is important since it indicates the uniformness of the flow distribution over the individual channels. As can be seen, the flow distribution not particularly uniform for pure water ($t=0$ s), but gets significantly even less uniform when the gas production starts ($t=1$ and 2 s). At $t=10$ s the distribution has relaxed back to a somewhat more uniform profile, but still less uniform than for pure water. It is also seen that the flow field distribution does not change

significantly between 2 s and 10 s. This indicates that a stationary flow distribution is established fairly soon after full oxygen production has been reached at 1 s.

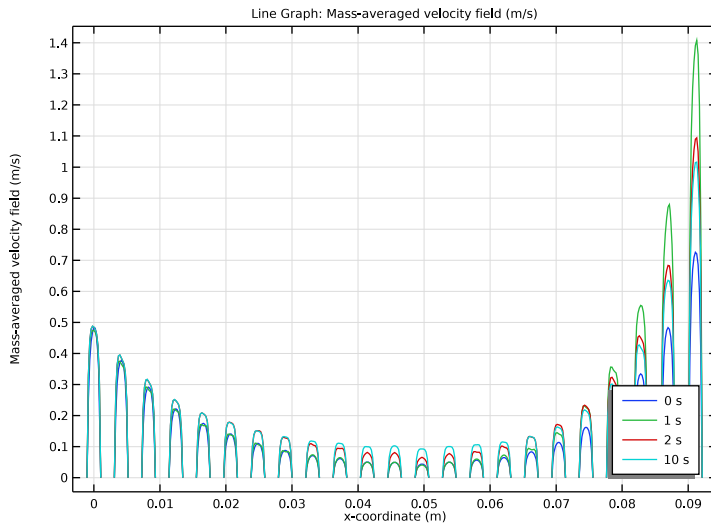

Figure 6: Individual channel velocities at various times.

Notes About the COMSOL Implementation

The local oxygen flux is multiplied by a smoothed step function, going from 1 to 0 when the volume fraction of oxygen approaches 1. The smoothing improves convergence.

Reference

1. J. Nie and Y. Chen, *Numerical modeling of three-dimensional two-phase gas-liquid flow in the field plate of a PEM electrolysis cell*, Int. J. Hydrogen Energy 35 (2010) 3183-3197
2. J. Nie, Y. Chen, S. Cohen, B. Carter and R. Boehm, *Numerical and experimental study of three-dimensional fluid flow in the bipolar plate of a PEM electrolysis cell*, Int. J. Thermal Sciences 48 (2009) 1914-1922.

Application Library path: Fuel_Cell_and_Electrolyzer_Module/Electrolyzers/
pem_electrolyzer



Modeling Instructions

From the **File** menu, choose **New**.

NEW

In the **New** window, click  **Model Wizard**.

MODEL WIZARD

- 1 In the **Model Wizard** window, click  **3D**.
- 2 In the **Select Physics** tree, select **Fluid Flow>Multiphase Flow>Mixture Model>Mixture Model, Laminar Flow (mm)**.
- 3 Click **Add**.
- 4 Click  **Study**.
- 5 In the **Select Study** tree, select **General Studies>Time Dependent**.
- 6 Click  **Done**.

GEOMETRY I

The model geometry is available as a parameterized geometry sequence in a separate MPH-file. If you want to build it from scratch, follow the instructions in the section [Appendix — Geometry Modeling Instructions](#). Otherwise load it from file with the following steps.

- 1 In the **Geometry** toolbar, click **Insert Sequence** and choose **Insert Sequence**.
- 2 Browse to the model's Application Libraries folder and double-click the file pem_electrolyzer_geom_sequence.mph.

3 In the **Geometry** toolbar, click  **Build All**.

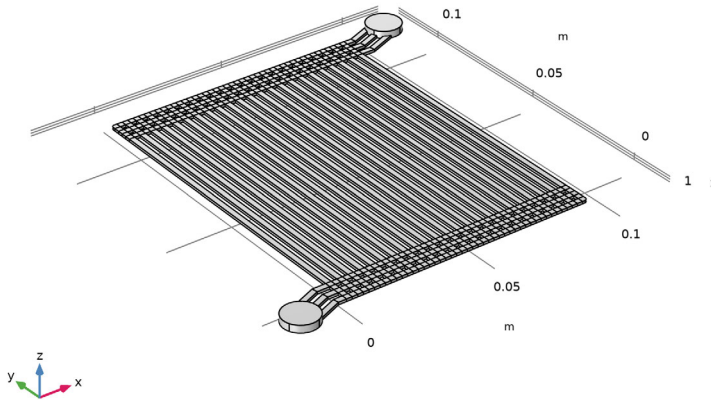

GLOBAL DEFINITIONS

Use the parameterization to reduce the number of channels and the channel lengths when setting up the model. It is often a good practice to start a modeling project on a reduced geometry size (or dimension). This saves time and computational resources while troubleshooting.

Parameters 1

- 1 In the **Model Builder** window, under **Global Definitions** click **Parameters 1**.
- 2 In the **Settings** window for **Parameters**, locate the **Parameters** section.
- 3 In the table, enter the following settings:

Name	Expression	Value	Description
N_ch	3	3	Number of electrode channels
L_ch	$118 \cdot h_a / 5$	0.02098 m	Electrode channel lengths

GEOMETRY 1

- 1 In the **Geometry** toolbar, click  **Build All**.

- 2 Click the  **Zoom Extents** button in the **Graphics** toolbar.

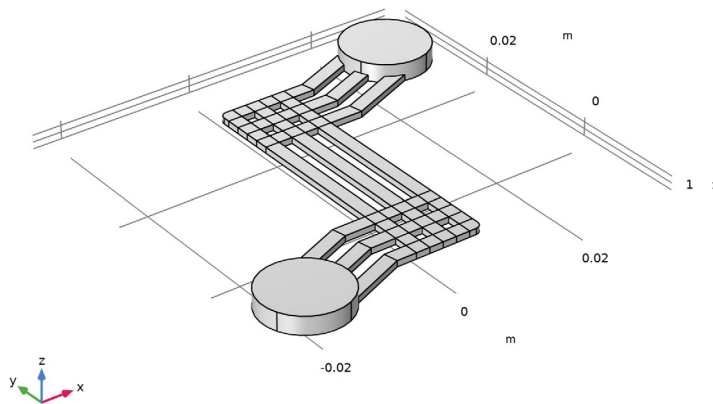

GLOBAL DEFINITIONS

Load some more physics parameters and variables from text files. Note that parameters and variables defining the oxygen and water flows are scaled with the geometric parameters.

Parameters 1

- 1 In the **Model Builder** window, under **Global Definitions** click **Parameters 1**.
- 2 In the **Settings** window for **Parameters**, locate the **Parameters** section.
- 3 Click  **Load from File**.
- 4 Browse to the model's Application Libraries folder and double-click the file `pem_electrolyzer_parameters.txt`.

DEFINITIONS

Variables 1

- 1 In the **Model Builder** window, under **Component 1 (comp1)** right-click **Definitions** and choose **Variables**.
- 2 In the **Settings** window for **Variables**, locate the **Variables** section.
- 3 Click  **Load from File**.

- 4 Browse to the model's Application Libraries folder and double-click the file `pem_electrolyzer_variables.txt`.

The variables make use of a step and a ramp function. These have not yet been defined, hence some of the loaded variable expressions are marked in orange. Define the missing functions as follows:

Step 1 (step1)

- 1 In the **Home** toolbar, click **f(x) Functions** and choose **Local>Step**.
- 2 In the **Settings** window for **Step**, locate the **Parameters** section.
- 3 In the **Location** text field, type `0.95`.
- 4 In the **From** text field, type `1`.
- 5 In the **To** text field, type `0`.
- 6 Click to expand the **Smoothing** section. In the **Size of transition zone** text field, type `0.1`.
- 7 Click  **Plot**.

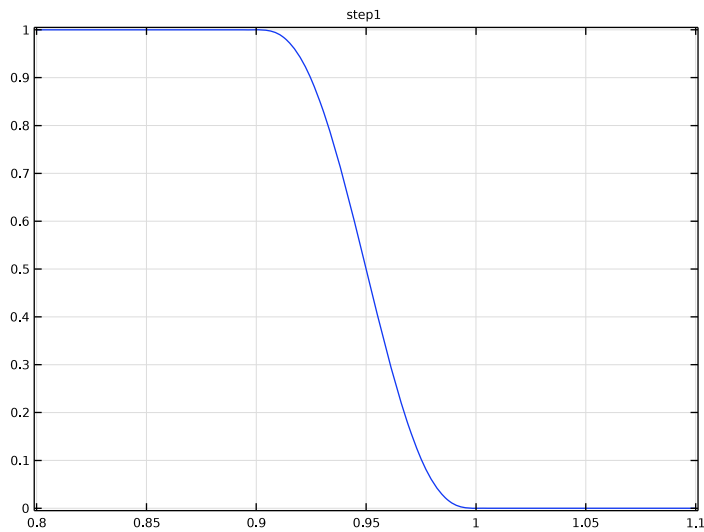

The step function is used to set the oxygen flux to zero locally when the gas volume fraction approaches 1. Smoothing is important in order to avoid discrete jumps in the flux. We will decrease the smoothing later when solving for the full model.

Ramp 1 (rm1)

- 1 In the **Home** toolbar, click **f(x) Functions** and choose **Local>Ramp**.
- 2 In the **Settings** window for **Ramp**, locate the **Parameters** section.

3 Select the **Cutoff** check box.

4 Click  **Plot**.

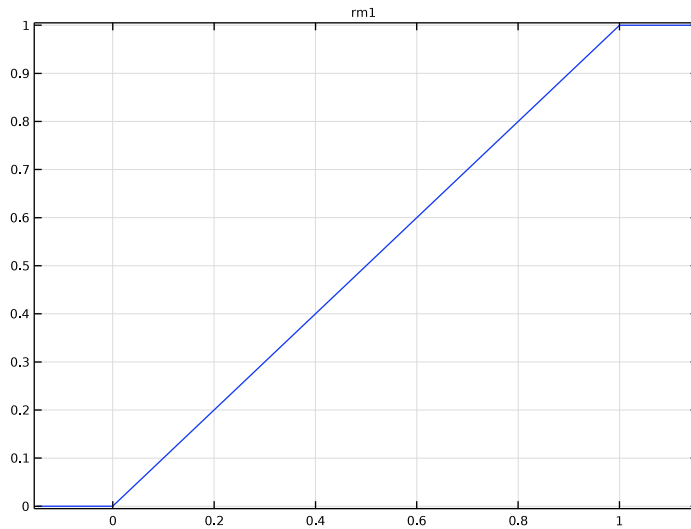

The ramp function is used to ramp up the oxygen flux from zero when the time-dependent solver starts. This shortens the computational time.

DEFINITIONS

In the **Model Builder** window, collapse the **Component 1 (comp1)>Definitions** node.

ADD MATERIAL

1 In the **Home** toolbar, click  **Add Material** to open the **Add Material** window.

Add liquid water and oxygen gas from the Material Library. Note that the order is important - Add water first.

2 Go to the **Add Material** window.

3 In the tree, select **Built-in>Water, liquid**.

4 Right-click and choose **Add to Component 1 (comp1)**.

5 In the tree, select **Liquids and Gases>Gases>Oxygen**.

6 Right-click and choose **Add to Component 1 (comp1)**.

7 In the **Home** toolbar, click  **Add Material** to close the **Add Material** window.

The oxygen node under Materials should now have a small warning symbol in the Model Builder Tree. This is because the selection of this node is zero. This is expected at this point.

Since the water node was added first, it got assigned to all domains by default.

MIXTURE MODEL, LAMINAR FLOW (MM)

1 In the **Settings** window for **Mixture Model, Laminar Flow**, locate the **Physical Model** section.

2 From the **Dispersed phase** list, choose **Liquid droplets/bubbles**.

3 From the **Slip model** list, choose **Schiller-Naumann**.

In this model, water is the continuous phase, and oxygen the dispersed phase.

Mixture Properties 1

1 In the **Model Builder** window, under **Component 1 (comp1)>Mixture Model, Laminar Flow (mm)** click **Mixture Properties 1**.

2 In the **Settings** window for **Mixture Properties**, locate the **Materials** section.

3 From the **Continuous phase** list, choose **Water, liquid (mat1)**.

4 From the **Dispersed phase** list, choose **Oxygen (mat2)**.

5 Locate the **Dispersed Phase Properties** section. From the ρ_d list, choose **User defined**. In the associated text field, type rho02.

6 In the d_d text field, type D_bubbles.

7 Locate the **Mixture Model** section. From the **Mixture viscosity model** list, choose **Volume averaged**.

Inlet - Liquid Water

1 In the **Physics** toolbar, click  **Boundaries** and choose **Inlet**.

2 In the **Settings** window for **Inlet**, type Inlet - Liquid Water in the **Label** text field.

3 Locate the **Boundary Selection** section. From the **Selection** list, choose **Inlet**.

4 Locate the **Velocity** section. In the J_0 text field, type Flow_rate/ (pi*R_in^2).

Inlet - Electrode Surface Oxygen Evolution

1 In the **Physics** toolbar, click  **Boundaries** and choose **Inlet**.

2 In the **Settings** window for **Inlet**, type Inlet - Electrode Surface Oxygen Evolution in the **Label** text field.

3 Locate the **Boundary Selection** section. From the **Selection** list, choose **Electrode Surface**.

- 4 Locate the **Velocity** section. In the J_0 text field, type `mixture_flow`.
- 5 Locate the **Dispersed Phase Boundary Condition** section. From the **Dispersed phase boundary condition** list, choose **Dispersed phase flux**.
- 6 In the $N_{\phi d}$ text field, type `disp_flow`.

Outlet 1

- 1 In the **Physics** toolbar, click  **Boundaries** and choose **Outlet**.
- 2 In the **Settings** window for **Outlet**, locate the **Boundary Selection** section.
- 3 From the **Selection** list, choose **Outlet**.

Gravity 1

- 1 In the **Physics** toolbar, click  **Domains** and choose **Gravity**.
The cell is oriented so that the z direction points upward.
- 2 In the **Settings** window for **Gravity**, locate the **Domain Selection** section.
- 3 From the **Selection** list, choose **All domains**.
- 4 Locate the **Gravity** section. Specify the \mathbf{g} vector as

0	x
0	y
-g_const	z

MESH 1

Manual meshing is required for a geometry of this complexity. Use a swept mesh along the electrode channels, and free tetrahedral meshing for the remaining domains.

- 1 In the **Model Builder** window, under **Component 1 (comp1)** click **Mesh 1**.
- 2 In the **Settings** window for **Mesh**, locate the **Sequence Type** section.
- 3 From the list, choose **Physics-controlled mesh**.

Swept 1

In the **Mesh** toolbar, click  **Swept**.

Size

- 1 In the **Model Builder** window, click **Size**.
- 2 In the **Settings** window for **Size**, locate the **Element Size** section.
- 3 From the **Predefined** list, choose **Finer**.

Swept 1

- 1 In the **Model Builder** window, click **Swept 1**.
- 2 In the **Settings** window for **Swept**, locate the **Domain Selection** section.
- 3 From the **Geometric entity level** list, choose **Domain**.
- 4 From the **Selection** list, choose **Channels Above Electrode Surface**.
- 5 Click to expand the **Source Faces** section. From the **Selection** list, choose **Inlets to Electrode Channels**.
- 6 Click to expand the **Destination Faces** section. From the **Selection** list, choose **Outlets from Electrode Channels**.

Distribution 1

- 1 Right-click **Swept 1** and choose **Distribution**.
- 2 In the **Settings** window for **Distribution**, locate the **Domain Selection** section.
- 3 From the **Selection** list, choose **Channels Above Electrode Surface**.
- 4 Locate the **Distribution** section. In the **Number of elements** text field, type $\text{floor}(L_{\text{ch}} / (0.5 * w_{\text{ch}}))$.

Size 1

- 1 Right-click **Swept 1** and choose **Size**.
- 2 In the **Settings** window for **Size**, locate the **Element Size** section.
- 3 Click the **Custom** button.
- 4 Locate the **Geometric Entity Selection** section. From the **Geometric entity level** list, choose **Boundary**.
- 5 From the **Selection** list, choose **Inlets to Electrode Channels**.
- 6 Locate the **Element Size Parameters** section. Select the **Maximum element size** check box.
- 7 In the associated text field, type $h_a/4$.

8 Click  **Build Selected**.

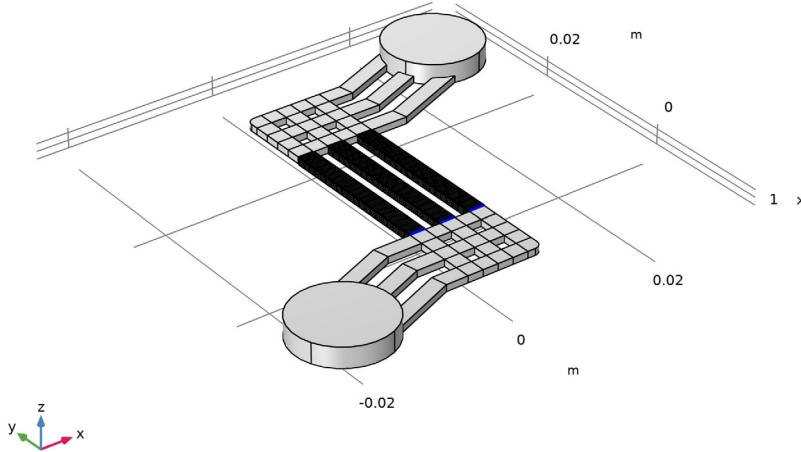

Free Tetrahedral I

- 1 In the **Mesh** toolbar, click  **Free Tetrahedral**.
- 2 In the **Settings** window for **Free Tetrahedral**, locate the **Domain Selection** section.
- 3 From the **Geometric entity level** list, choose **Domain**.
- 4 From the **Selection** list, choose **Manifolds**.
- 5 Click to expand the **Scale Geometry** section. In the **z-direction scale** text field, type 2.

Size I

- 1 Right-click **Free Tetrahedral I** and choose **Size**.
- 2 In the **Settings** window for **Size**, locate the **Element Size** section.
- 3 Click the **Custom** button.
- 4 Locate the **Element Size Parameters** section. Select the **Maximum element size** check box.
- 5 In the associated text field, type $w_{ch}/4$.

6 Click  **Build Selected**.

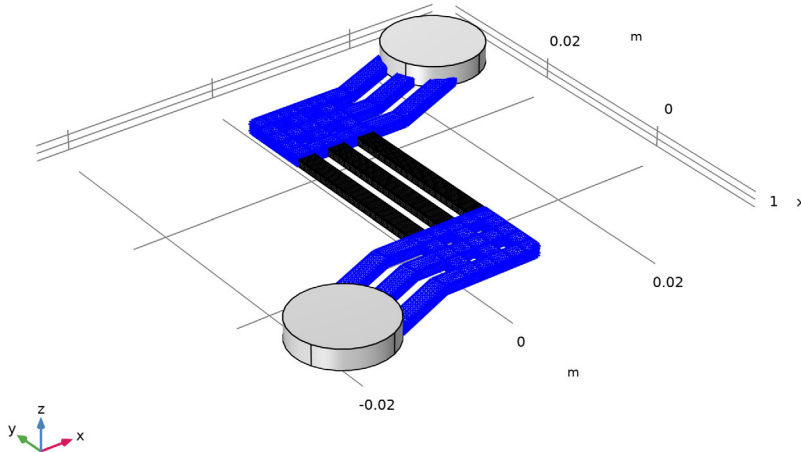

Free Tetrahedral 2

- 1 In the **Mesh** toolbar, click  **Free Tetrahedral**.
- 2 In the **Settings** window for **Free Tetrahedral**, locate the **Scale Geometry** section.
- 3 In the **z-direction scale** text field, type 2.

Size 1

- 1 Right-click **Free Tetrahedral 2** and choose **Size**.
- 2 In the **Settings** window for **Size**, locate the **Element Size** section.
- 3 Click the **Custom** button.
- 4 Locate the **Element Size Parameters** section. Select the **Maximum element size** check box.
- 5 In the associated text field, type h_a.

6 Click  **Build Selected.**

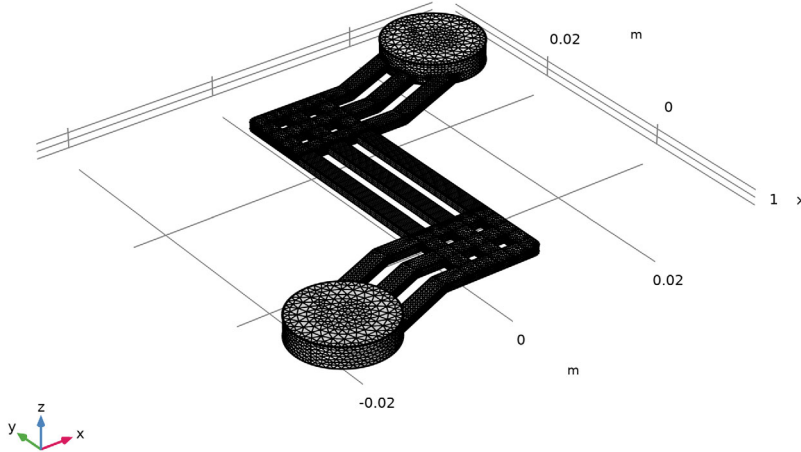

Boundary Layers I

Add boundary layer meshing to resolve steep velocity gradients at the inlet and outlet regions to the electrode channels and along the walls..

- 1 In the **Mesh** toolbar, click  **Boundary Layers.**
- 2 In the **Settings** window for **Boundary Layers**, locate the **Geometric Entity Selection** section.
- 3 From the **Geometric entity level** list, choose **Domain.**
- 4 From the **Selection** list, choose **Channels Above Electrode Surface.**

Boundary Layer Properties

- 1 In the **Model Builder** window, click **Boundary Layer Properties.**
- 2 In the **Settings** window for **Boundary Layer Properties**, locate the **Boundary Selection** section.
- 3 From the **Selection** list, choose **Inlets and Outlets to Electrode Channels.**
- 4 Locate the **Layers** section. In the **Number of layers** text field, type 4.
- 5 From the **Thickness specification** list, choose **First layer.**
- 6 In the **Thickness** text field, type $w_{ch}/15$.

7 Click  **Build Selected**.

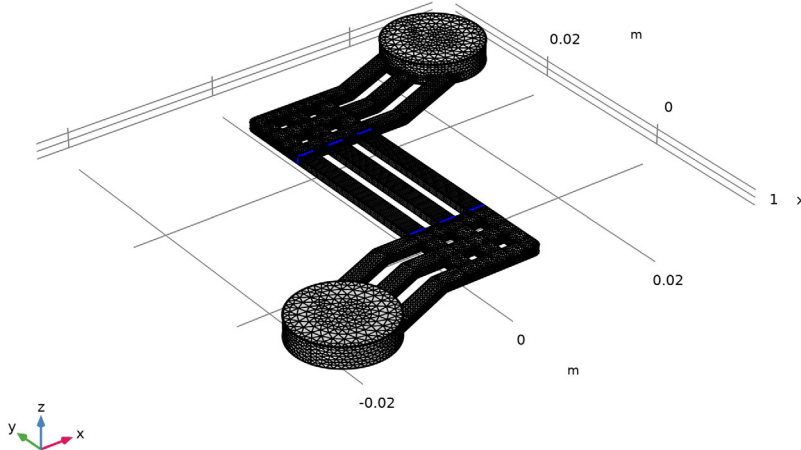

STUDY 1

The problem is now ready for solving. Add a Stationary study step to first solve for the velocity and pressure fields for pure liquid water. This solution will then be used as initial values for the time-dependent simulation.

Stationary

- 1 In the **Study** toolbar, click  **Study Steps** and choose **Stationary>Stationary**.
- 2 Right-click **Study 1>Step 2: Stationary** and choose **Move Up**.

Step 2: Time Dependent

- 1 In the **Model Builder** window, click **Step 2: Time Dependent**.
- 2 In the **Settings** window for **Time Dependent**, locate the **Study Settings** section.
- 3 In the **Output times** text field, type 0 1 2 10.

Solution 1 (sol1)

- 1 In the **Study** toolbar, click  **Show Default Solver**.
- 2 In the **Model Builder** window, expand the **Solution 1 (sol1)** node, then click **Dependent Variables 1**.
- 3 In the **Settings** window for **Dependent Variables**, locate the **General** section.

- 4 From the **Defined by study step** list, choose **User defined**.
- 5 In the **Model Builder** window, expand the **Study 1>Solver Configurations>Solution 1 (sol1)>Dependent Variables 1** node, then click **Volume fraction, dispersed phase (comp1.phid)**.
- 6 In the **Settings** window for **Field**, locate the **General** section.
- 7 Clear the **Solve for this field** check box.
- 8 In the **Model Builder** window, under **Study 1>Solver Configurations>Solution 1 (sol1)>Dependent Variables 1** click **Squared slip velocity (comp1.slipvel)**.
- 9 In the **Settings** window for **Field**, locate the **General** section.
- 10 Clear the **Solve for this field** check box.
By setting the scales for the velocity, pressure and volume fraction of the dispersed phase, the computation time can be reduced.
- 11 In the **Model Builder** window, expand the **Study 1>Solver Configurations>Solution 1 (sol1)>Dependent Variables 2** node, then click **Velocity field, mixture (comp1.j)**.
- 12 In the **Settings** window for **Field**, locate the **Scaling** section.
- 13 From the **Method** list, choose **Initial value based**.
- 14 In the **Model Builder** window, under **Study 1>Solver Configurations>Solution 1 (sol1)>Dependent Variables 2** click **Pressure (comp1.p)**.
- 15 In the **Settings** window for **Field**, locate the **Scaling** section.
- 16 From the **Method** list, choose **Initial value based**.
- 17 In the **Model Builder** window, under **Study 1>Solver Configurations>Solution 1 (sol1)>Dependent Variables 2** click **Volume fraction, dispersed phase (comp1.phid)**.
- 18 In the **Settings** window for **Field**, locate the **Scaling** section.
- 19 From the **Method** list, choose **Manual**.
- 20 In the **Model Builder** window, click **Study 1**.
- 21 In the **Settings** window for **Study**, locate the **Study Settings** section.
- 22 Clear the **Generate default plots** check box.
- 23 In the **Study** toolbar, click  **Compute**.

The model should take about half an hour to solve.

RESULTS

Create plots for the pressure, velocity and gas volume fraction as follows:

Pressure

- 1 In the **Home** toolbar, click  **Add Plot Group** and choose **3D Plot Group**.
- 2 In the **Settings** window for **3D Plot Group**, type Pressure in the **Label** text field.

Surface 1

- 1 Right-click **Pressure** and choose **Surface**.
- 2 In the **Settings** window for **Surface**, click **Replace Expression** in the upper-right corner of the **Expression** section. From the menu, choose **Component 1 (comp1)>Mixture Model, Laminar Flow>VelAndPressure>p - Pressure - Pa**.
- 3 In the **Pressure** toolbar, click  **Plot**.

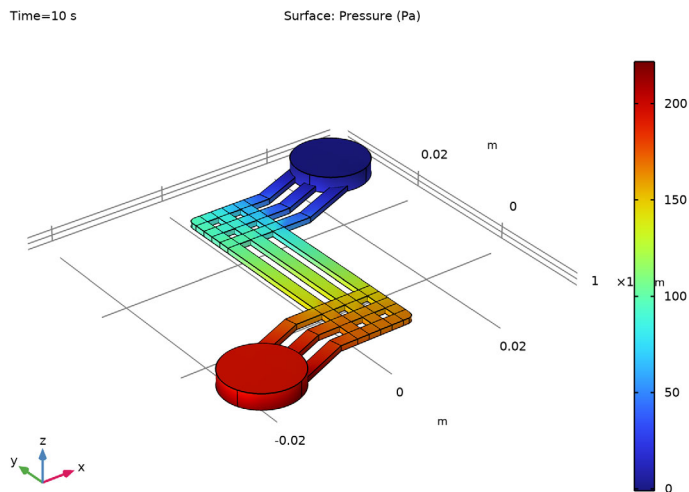

Velocity

- 1 In the **Home** toolbar, click  **Add Plot Group** and choose **3D Plot Group**.
- 2 In the **Settings** window for **3D Plot Group**, type Velocity in the **Label** text field.

Slice 1

- 1 Right-click **Velocity** and choose **Slice**.
- 2 In the **Settings** window for **Slice**, click **Replace Expression** in the upper-right corner of the **Expression** section. From the menu, choose **Component 1 (comp1)>Mixture Model, Laminar Flow>VelAndPressure>mm.U - Mass-averaged velocity field - m/s**.
- 3 Locate the **Plane Data** section. From the **Plane** list, choose **xy-planes**.
- 4 From the **Entry method** list, choose **Coordinates**.

5 In the **z-coordinates** text field, type $h_a/2$.

6 In the **Velocity** toolbar, click  **Plot**.

Time=10 s

Slice: Mass-averaged velocity field (m/s)

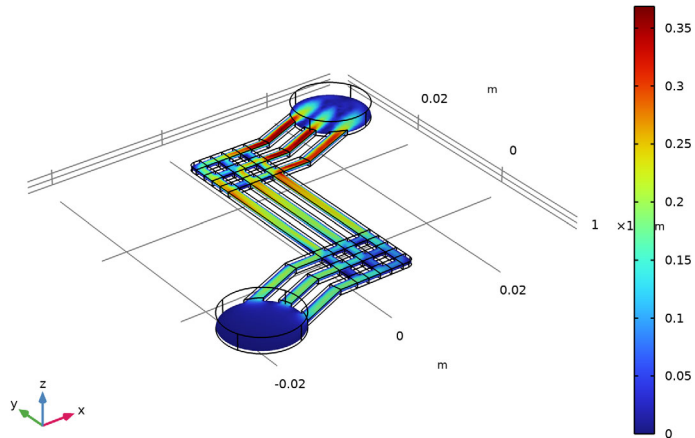

Gas Volume Fraction

1 In the **Home** toolbar, click  **Add Plot Group** and choose **3D Plot Group**.

2 In the **Settings** window for **3D Plot Group**, type Gas Volume Fraction in the **Label** text field.

Surface 1

1 Right-click **Gas Volume Fraction** and choose **Surface**.

2 In the **Gas Volume Fraction** toolbar, click  **Plot**.

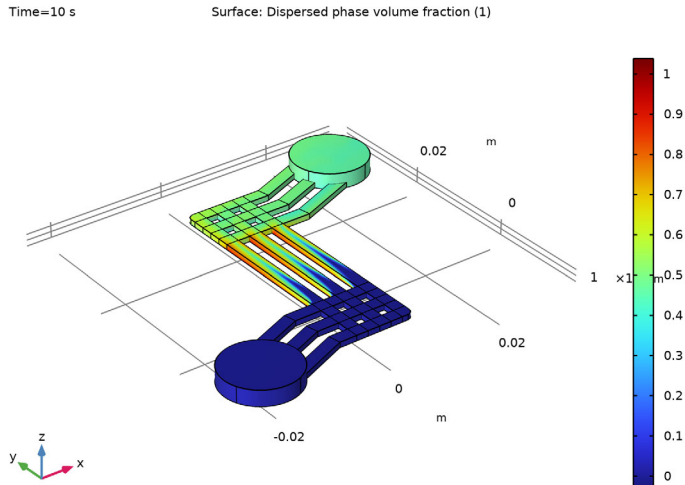

Cut Line 3D 1

- 1 In the **Results** toolbar, click  **Cut Line 3D**.
- 2 In the **Settings** window for **Cut Line 3D**, locate the **Line Data** section.
- 3 In row **Point 1**, set **x** to $-w_{ch}/2$.
- 4 In row **Point 1**, set **y** to $L_{ch}/2$.
- 5 In row **Point 1**, set **z** to $h_a/2$.
- 6 In row **Point 2**, set **x** to $N_{ch} \cdot w_{ch} \cdot 2 - 3 \cdot w_{ch} / 2$.
- 7 In row **Point 2**, set **y** to $L_{ch}/2$.
- 8 In row **Point 2**, set **z** to $h_a/2$.

Velocity in Electrode Channels

- 1 In the **Results** toolbar, click  **ID Plot Group**.
- 2 In the **Settings** window for **ID Plot Group**, type **Velocity in Electrode Channels** in the **Label** text field.
- 3 Locate the **Data** section. From the **Dataset** list, choose **Cut Line 3D 1**.

Line Graph 1

- 1 Right-click **Velocity in Electrode Channels** and choose **Line Graph**.

- 2 In the **Settings** window for **Line Graph**, click **Replace Expression** in the upper-right corner of the **y-Axis Data** section. From the menu, choose **Component 1 (comp1)>Mixture Model, Laminar Flow>VelAndPressure>mm.U - Mass-averaged velocity field - m/s**.
- 3 Locate the **x-Axis Data** section. From the **Parameter** list, choose **Expression**.
- 4 In the **Expression** text field, type **x**.
- 5 Click to expand the **Legends** section. Select the **Show legends** check box.

Velocity in Electrode Channels

- 1 In the **Model Builder** window, click **Velocity in Electrode Channels**.
- 2 In the **Settings** window for **ID Plot Group**, locate the **Legend** section.
- 3 From the **Position** list, choose **Lower right**.
- 4 In the **Velocity in Electrode Channels** toolbar, click  **Plot**.

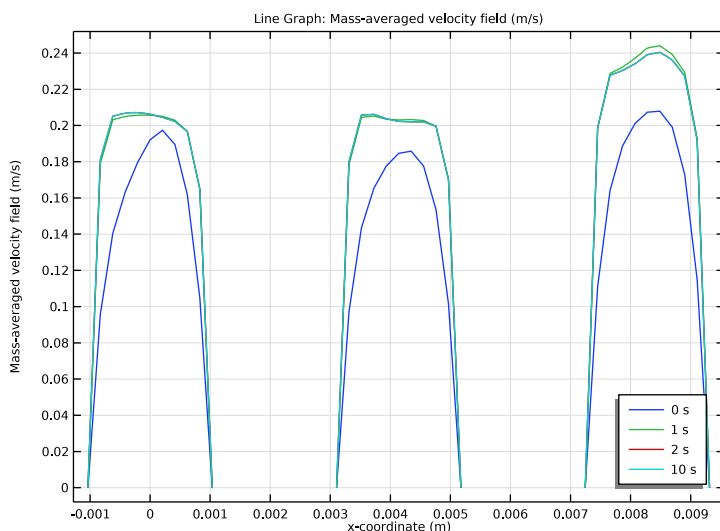

GLOBAL DEFINITIONS

Now model the full geometry. Go back and set the number of channels and the cell length to their original values.

Parameters 1

- 1 In the **Model Builder** window, under **Global Definitions** click **Parameters 1**.
- 2 In the **Settings** window for **Parameters**, locate the **Parameters** section.

3 In the table, enter the following settings:

Name	Expression	Value	Description
N_ch	23	23	Number of electrode channels
L_ch	118*h_a	0.1049 m	Electrode channel lengths

GEOMETRY I

1 In the **Home** toolbar, click  **Build All**.

2 Click the  **Zoom Extents** button in the **Graphics** toolbar.

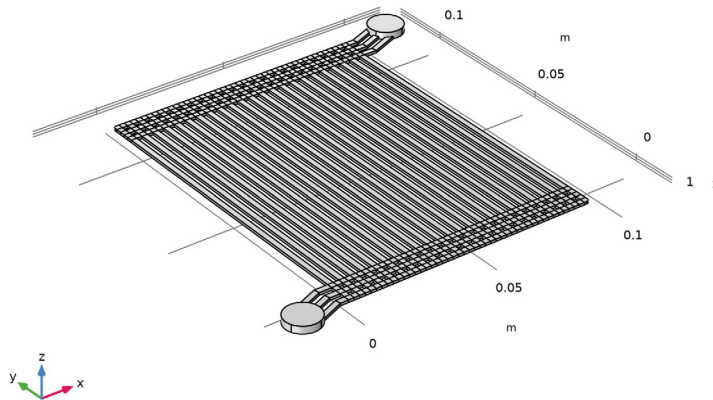

MESH I

Inspect the mesh after the geometry change.

In the **Model Builder** window, under **Component 1 (comp1)** right-click **Mesh 1** and choose **Build All**.

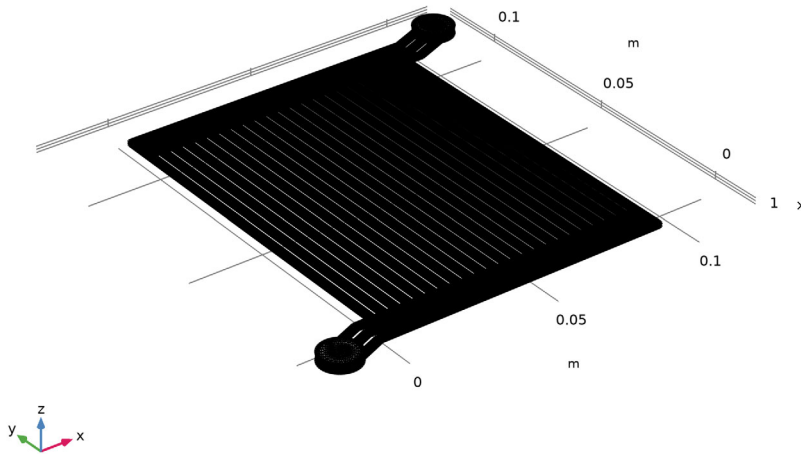

DEFINITIONS

Step 1 (step1)

Decrease the smoothing of the step function.

- 1 In the **Model Builder** window, under **Component 1 (comp1)**>**Definitions** click **Step 1 (step1)**.
- 2 In the **Settings** window for **Step**, locate the **Parameters** section.
- 3 In the **Location** text field, type 0.995.
- 4 Locate the **Smoothing** section. In the **Size of transition zone** text field, type 0.01.

5 Click  **Plot**.

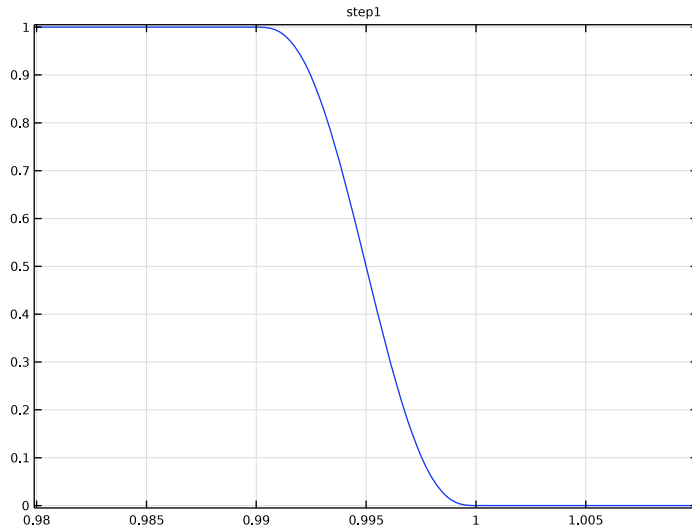

STUDY 1

Solution 1 (sol1)

Before solving, make a copy of the solution for the small geometry to keep it for future reference.

- 1 In the **Model Builder** window, under **Study 1 > Solver Configurations** right-click **Solution 1 (sol1)** and choose **Solution > Copy**.

Solution - Small Geometry

- 1 In the **Model Builder** window, under **Study 1 > Solver Configurations** click **Solution 1 - Copy 1 (sol3)**.
- 2 In the **Settings** window for **Solution**, type **Solution - Small Geometry** in the **Label** text field.

Solver Configurations

Reset the solver sequence in order to obtain the default solver for the new problem size.

Solution 1 (sol1)

- 1 In the **Model Builder** window, right-click **Solver Configurations** and choose **Reset Solver to Default**.
- 2 In the **Settings** window for **Dependent Variables**, locate the **General** section.

- 3 From the **Defined by study step** list, choose **User defined**.
- 4 In the **Model Builder** window, expand the **Study 1>Solver Configurations>Solution 1 (sol1)>Dependent Variables 1** node, then click **Volume fraction, dispersed phase (comp1.phid)**.
- 5 In the **Settings** window for **Field**, locate the **General** section.
- 6 Clear the **Solve for this field** check box.
- 7 In the **Model Builder** window, click **Squared slip velocity (comp1.slipvel)**.
- 8 In the **Settings** window for **Field**, locate the **General** section.
- 9 Clear the **Solve for this field** check box.
- 10 In the **Model Builder** window, expand the **Study 1>Solver Configurations>Solution 1 (sol1)>Dependent Variables 2** node, then click **Volume fraction, dispersed phase (comp1.phid)**.
- 11 In the **Settings** window for **Field**, locate the **Scaling** section.
- 12 From the **Method** list, choose **Manual**.
- 13 In the **Model Builder** window, click **Squared slip velocity (comp1.slipvel)**.
- 14 In the **Settings** window for **Field**, locate the **Scaling** section.
- 15 From the **Method** list, choose **Manual**.
- 16 In the **Scale** text field, type $1e-5$.

Step 2: Time Dependent

The problem will take several hours to solve. Plot the gas volume fraction while solving in order to monitor the solution process.

- 1 In the **Model Builder** window, under **Study 1** click **Step 2: Time Dependent**.
- 2 In the **Settings** window for **Time Dependent**, click to expand the **Results While Solving** section.
- 3 Select the **Plot** check box.
- 4 From the **Plot group** list, choose **Gas Volume Fraction**.
- 5 From the **Update at** list, choose **Time steps taken by solver**.
The full problem is now ready for solving.
- 6 In the **Home** toolbar, click  **Compute**.

RESULTS

Pressure

1 In the **Pressure** toolbar, click  **Plot**.

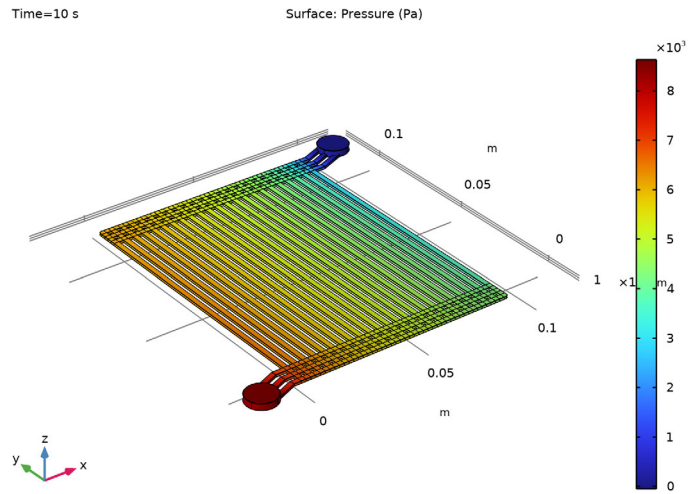

2 In the **Settings** window for **3D Plot Group**, locate the **Data** section.

3 From the **Time (s)** list, choose **0**.

4 In the **Pressure** toolbar, click  **Plot**.

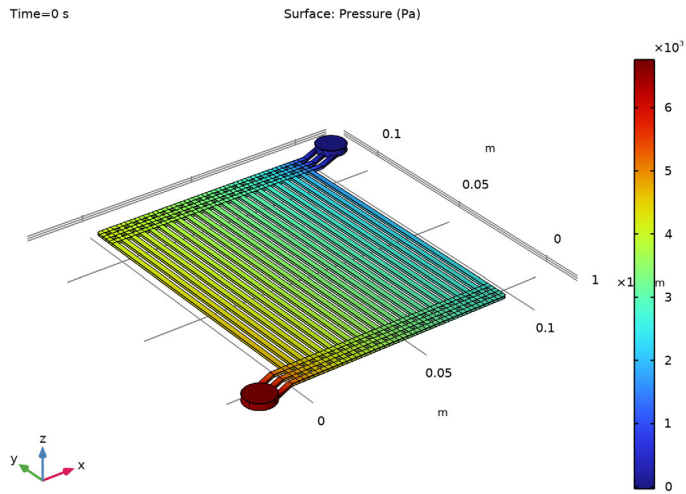

5 From the **Time (s)** list, choose **10**.

Velocity

1 In the **Model Builder** window, click **Velocity**.

2 In the **Velocity** toolbar, click  **Plot**.

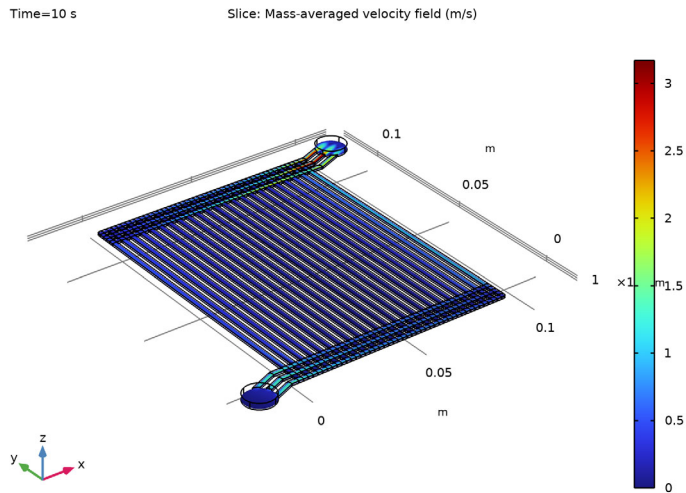

Gas Volume Fraction

- 1 In the **Model Builder** window, click **Gas Volume Fraction**.
- 2 In the **Gas Volume Fraction** toolbar, click  **Plot**.

Time=10 s

Surface: Dispersed phase volume fraction (1)

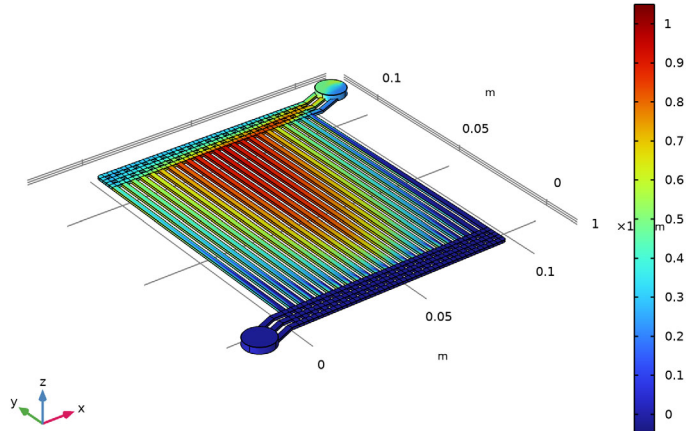

Velocity in Electrode Channels

- 1 In the **Model Builder** window, click **Velocity in Electrode Channels**.

2 In the **Velocity in Electrode Channels** toolbar, click  **Plot**.

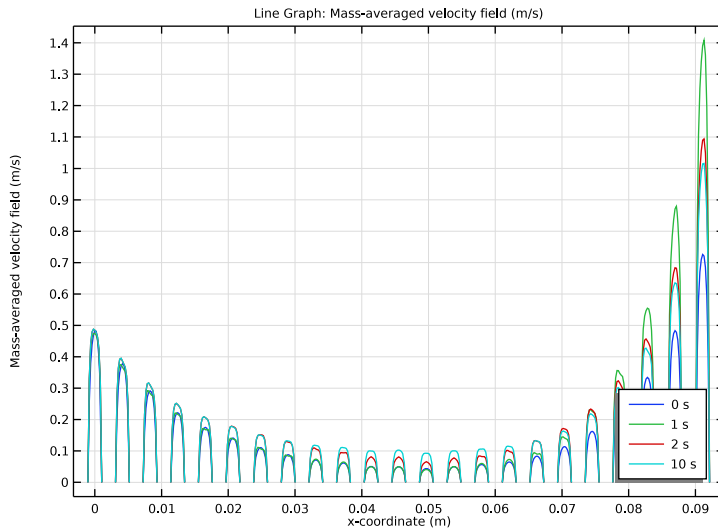

Appendix — Geometry Modeling Instructions

From the **File** menu, choose **New**.

NEW

In the **New** window, click  **Model Wizard**.

MODEL WIZARD

1 In the **Model Wizard** window, click  **3D**.

2 Click **Done**.

GLOBAL DEFINITIONS

Parameters 1

1 In the **Model Builder** window, under **Global Definitions** click **Parameters 1**.

2 In the **Settings** window for **Parameters**, locate the **Parameters** section.

3 Click  **Load from File**.

4 Browse to the model's Application Libraries folder and double-click the file `pem_electrolyzer_geom_sequence_parameters.txt`.

GEOMETRY I



Work Plane 1 (wp1)

In the **Geometry** toolbar, click  **Work Plane**.



Work Plane 1 (wp1)>Plane Geometry

In the **Model Builder** window, click **Plane Geometry**.



Work Plane 1 (wp1)>Circle 1 (c1)

- 1 In the **Work Plane** toolbar, click  **Circle**.
- 2 In the **Settings** window for **Circle**, locate the **Size and Shape** section.
- 3 In the **Radius** text field, type R_{in} .
- 4 Click  **Build Selected**.
- 5 Click the  **Zoom Extents** button in the **Graphics** toolbar.

Work Plane 1 (wp1)>Rectangle 1 (r1)

- 1 In the **Work Plane** toolbar, click  **Rectangle**.
- 2 In the **Settings** window for **Rectangle**, locate the **Size and Shape** section.
- 3 In the **Width** text field, type $L_{inout} * 3/4$.
- 4 In the **Height** text field, type w_{ch} .
- 5 Locate the **Position** section. In the **yw** text field, type $-w_{ch} * 2.5$.
- 6 Click  **Build Selected**.

Work Plane 1 (wp1)>Rectangle 2 (r2)

- 1 In the **Work Plane** toolbar, click  **Rectangle**.
- 2 In the **Settings** window for **Rectangle**, locate the **Size and Shape** section.
- 3 In the **Width** text field, type $L_{inout} * 1/4$.
- 4 In the **Height** text field, type w_{ch} .
- 5 Locate the **Position** section. In the **xw** text field, type $L_{inout} * 3/4$.
- 6 In the **yw** text field, type $-w_{ch} * 2.5$.
- 7 Click  **Build Selected**.
- 8 Click the  **Zoom Extents** button in the **Graphics** toolbar.

Work Plane 1 (wp1)>Array 1 (arr1)

- 1 In the **Work Plane** toolbar, click  **Transforms** and choose **Array**.
- 2 Select the objects **r1** and **r2** only.
- 3 In the **Settings** window for **Array**, locate the **Size** section.

- 4 In the **yw size** text field, type 3.
- 5 Locate the **Displacement** section. In the **yw** text field, type $2*w_ch$.
- 6 Click  **Build Selected**.



Work Plane 1 (wp1)>Polygon 1 (pol1)

- 1 In the **Work Plane** toolbar, click  **Polygon**.
- 2 In the **Settings** window for **Polygon**, locate the **Coordinates** section.
- 3 In the table, enter the following settings:

xw (m)	yw (m)
$L_inout*3/4$	$2*w_ch*1.25$
$L_inout*3/4$	$-2*w_ch*1.25$
$L_inout*3/4-5*w_ch*\tan(ang_inout/2)$	$-2*w_ch*1.25$

- 4 Click  **Build Selected**.

Work Plane 1 (wp1)>Difference 1 (dif1)

- 1 In the **Work Plane** toolbar, click  **Booleans and Partitions** and choose **Difference**.
- 2 Select the object **arr1(1,3,1)** only.
- 3 In the **Settings** window for **Difference**, locate the **Difference** section.
- 4 Click  **Clear Selection**.
- 5 Select the objects **arr1(1,1,1)**, **arr1(1,2,1)**, and **arr1(1,3,1)** only.
- 6 Find the **Objects to subtract** subsection. Click to select the **Activate Selection** toggle button.
- 7 Select the objects **c1** and **pol1** only.
- 8 Click  **Build Selected**.



Work Plane 1 (wp1)>Polygon 2 (pol2)

- 1 In the **Work Plane** toolbar, click  **Polygon**.
- 2 In the **Settings** window for **Polygon**, locate the **Coordinates** section.
- 3 In the table, enter the following settings:



xw (m)	yw (m)
$L_inout*3/4$	$2*w_ch*1.25$
$L_inout*3/4$	$-2*w_ch*1.25$
$L_inout*3/4+5*w_ch*\tan(ang_inout/2)$	$-2*w_ch*1.25$

- 4 Click  **Build Selected**.



Work Plane 1 (wp1)>Difference 2 (dif2)

- 1 In the **Work Plane** toolbar, click  **Booleans and Partitions** and choose **Difference**.
- 2 Select the objects **arr1(1,1,2)**, **arr1(1,2,2)**, and **arr1(1,3,2)** only.
- 3 In the **Settings** window for **Difference**, locate the **Difference** section.
- 4 Find the **Objects to subtract** subsection. Click to select the  **Activate Selection** toggle button.
- 5 Select the object **pol2** only.
- 6 Click  **Build Selected**.



Work Plane 1 (wp1)>Rotate 1 (rot1)

- 1 In the **Work Plane** toolbar, click  **Transforms** and choose **Rotate**.
- 2 Select the object **dif1** only.
- 3 In the **Settings** window for **Rotate**, locate the **Rotation** section.
- 4 In the **Angle** text field, type `ang_inout`.
- 5 Locate the **Center of Rotation** section. In the **xw** text field, type `L_inout*3/4`.
- 6 In the **yw** text field, type `2*w_ch*1.25`.
- 7 Click  **Build Selected**.

Work Plane 1 (wp1)>Union 1 (uni1)

- 1 In the **Work Plane** toolbar, click  **Booleans and Partitions** and choose **Union**.
- 2 Click in the **Graphics** window and then press **Ctrl+A** to select both objects.
- 3 In the **Settings** window for **Union**, click  **Build Selected**.

Work Plane 1 (wp1)>Move 1 (mov1)



- 1 In the **Work Plane** toolbar, click  **Transforms** and choose **Move**.
- 2 Select the object **uni1** only.
- 3 In the **Settings** window for **Move**, locate the **Displacement** section.
- 4 In the **xw** text field, type `-L_inout-w_ch*0.5`.
- 5 In the **yw** text field, type `-w_ch*2.5`.
- 6 Click  **Build Selected**.
- 7 Click the  **Zoom Extents** button in the **Graphics** toolbar.

Work Plane 1 (wp1)>Rectangle 3 (r3)

- 1 In the **Work Plane** toolbar, click  **Rectangle**.
- 2 In the **Settings** window for **Rectangle**, locate the **Size and Shape** section.

- 3 In the **Width** text field, type w_ch .
- 4 In the **Height** text field, type $L_ch+10*w_ch$.
- 5 Locate the **Position** section. In the **xw** text field, type $-w_ch/2$.
- 6 In the **yw** text field, type $-5*w_ch$.
- 7 Click  **Build Selected**.



Work Plane 1 (wp1)>Array 2 (arr2)

- 1 In the **Work Plane** toolbar, click  **Transforms** and choose **Array**.
- 2 Click the  **Zoom Extents** button in the **Graphics** toolbar.
- 3 Select the object **r3** only.
- 4 In the **Settings** window for **Array**, locate the **Size** section.
- 5 In the **xw size** text field, type N_ch .
- 6 Locate the **Displacement** section. In the **xw** text field, type w_ch*2 .
- 7 Click  **Build Selected**.



Work Plane 1 (wp1)>Rectangle 4 (r4)

- 1 In the **Work Plane** toolbar, click  **Rectangle**.
- 2 In the **Settings** window for **Rectangle**, locate the **Size and Shape** section.
- 3 In the **Width** text field, type $(N_ch-0.5)*(2*w_ch)$.
- 4 In the **Height** text field, type w_ch .
- 5 Locate the **Position** section. In the **xw** text field, type $-w_ch/2$.
- 6 In the **yw** text field, type $-w_ch*5$.

Work Plane 1 (wp1)>Array 3 (arr3)



- 1 In the **Work Plane** toolbar, click  **Transforms** and choose **Array**.
- 2 Select the object **r4** only.
- 3 In the **Settings** window for **Array**, locate the **Size** section.
- 4 In the **yw size** text field, type 3.
- 5 Locate the **Displacement** section. In the **yw** text field, type w_ch*2 .
- 6 Click  **Build Selected**.

Work Plane 1 (wp1)>Copy 1 (copy1)



- 1 In the **Work Plane** toolbar, click  **Transforms** and choose **Copy**.
- 2 Click the  **Zoom Extents** button in the **Graphics** toolbar.
- 3 Select the objects **arr3(1,1)**, **arr3(1,2)**, and **arr3(1,3)** only.

- 4 In the **Settings** window for **Copy**, locate the **Displacement** section.
- 5 In the **yw** text field, type L_ch+5*w_ch .
- 6 Click  **Build Selected**.



Work Plane 1 (wp1)>Rotate 2 (rot2)

- 1 In the **Work Plane** toolbar, click  **Transforms** and choose **Rotate**.
- 2 Select the object **mov1** only.
- 3 In the **Settings** window for **Rotate**, locate the **Rotation** section.
- 4 In the **Angle** text field, type 180.
- 5 Locate the **Center of Rotation** section. In the **xw** text field, type $(N_ch-1)*w_ch$.
- 6 In the **yw** text field, type $L_ch/2$.
- 7 Locate the **Input** section. Select the **Keep input objects** check box.
- 8 Click  **Build Selected**.

Work Plane 1 (wp1)>Union 2 (uni2)

- 1 In the **Work Plane** toolbar, click  **Booleans and Partitions** and choose **Union**.
- 2 Click the  **Select Box** button in the **Graphics** toolbar.
- 3 Click in the **Graphics** window and then press Ctrl+A to select all objects.

Fillet Selection 1



- 1 In the **Work Plane** toolbar, click  **Selections** and choose **Box Selection**.
- 2 In the **Settings** window for **Box Selection**, type *Fillet Selection 1* in the **Label** text field.
- 3 Locate the **Geometric Entity Level** section. From the **Level** list, choose **Point**.
- 4 Locate the **Box Limits** section. In the **xw maximum** text field, type 0.
- 5 In the **yw minimum** text field, type $L_ch+w_ch*4.5$.
- 6 Click  **Build Selected**.

Fillet Selection 2



- 1 In the **Work Plane** toolbar, click  **Selections** and choose **Box Selection**.
- 2 In the **Settings** window for **Box Selection**, type *Fillet Selection 2* in the **Label** text field.
- 3 Locate the **Geometric Entity Level** section. From the **Level** list, choose **Point**.
- 4 Locate the **Box Limits** section. In the **xw minimum** text field, type $2*w_ch*(N_ch-1)$.
- 5 In the **yw maximum** text field, type $-w_ch*4.5$.

6 Click  **Build Selected**.

Work Plane 1 (wp1)>Fillet 1 (fil1)

- 1 In the **Work Plane** toolbar, click  **Fillet**.
- 2 In the **Settings** window for **Fillet**, locate the **Points** section.
- 3 From the **Vertices to fillet** list, choose **Fillet Selection 1**.
- 4 Locate the **Radius** section. In the **Radius** text field, type $w_{ch}/2$.
- 5 Click  **Build Selected**.

Work Plane 1 (wp1)>Fillet 2 (fil2)

- 1 Right-click **Component 1 (comp1)>Geometry 1>Work Plane 1 (wp1)>Plane Geometry>Fillet 1 (fil1)** and choose **Duplicate**.
- 2 In the **Settings** window for **Fillet**, locate the **Points** section.
- 3 Find the **Vertices to fillet** subsection. Click to select the  **Activate Selection** toggle button.
- 4 From the **Vertices to fillet** list, choose **Fillet Selection 2**.
- 5 Click  **Build Selected**.

Extrude 1 (ext1)



- 1 In the **Model Builder** window, right-click **Geometry 1** and choose **Extrude**.
- 2 In the **Settings** window for **Extrude**, locate the **Distances** section.
- 3 In the table, enter the following settings:

Distances (m)

h_a

4 Click  **Build Selected**.

Cylinder 1 (cyl1)



- 1 In the **Geometry** toolbar, click  **Cylinder**.
- 2 In the **Settings** window for **Cylinder**, locate the **Size and Shape** section.
- 3 In the **Radius** text field, type R_{in} .
- 4 In the **Height** text field, type $3 \cdot h_a$.
- 5 Click  **Build Selected**.

Rotate 1 (rot1)



- 1 In the **Geometry** toolbar, click  **Transforms** and choose **Rotate**.
- 2 Select the object **cyl1** only.

- 3 In the **Settings** window for **Rotate**, locate the **Rotation** section.
- 4 In the **Angle** text field, type ang_inout .
- 5 Locate the **Point on Axis of Rotation** section. In the **x** text field, type $L_inout*3/4$.
- 6 In the **y** text field, type $2*w_ch*1.25$.
- 7 Click  **Build Selected**.



Move 1 (mov1)

- 1 In the **Geometry** toolbar, click  **Transforms** and choose **Move**.
- 2 Select the object **rot1** only.
- 3 In the **Settings** window for **Move**, locate the **Displacement** section.
- 4 In the **x** text field, type $-L_inout-w_ch*0.5$.
- 5 In the **y** text field, type $-w_ch*2.5$.
- 6 Click  **Build Selected**.

Rotate 2 (rot2)

- 1 In the **Geometry** toolbar, click  **Transforms** and choose **Rotate**.
- 2 Select the object **mov1** only.
- 3 In the **Settings** window for **Rotate**, locate the **Input** section.
- 4 Select the **Keep input objects** check box.
- 5 Locate the **Rotation** section. In the **Angle** text field, type 180.
- 6 Locate the **Point on Axis of Rotation** section. In the **x** text field, type $(N_ch-1)*w_ch$.
- 7 In the **y** text field, type $L_ch/2$.
- 8 Click  **Build Selected**.

Form Union (fin)

- 1 In the **Model Builder** window, click **Form Union (fin)**.
- 2 In the **Settings** window for **Form Union/Assembly**, click  **Build Selected**.
- 3 Click the  **Zoom Extents** button in the **Graphics** toolbar.

Inlet Manifold

- 1 In the **Geometry** toolbar, click  **Selections** and choose **Box Selection**.
- 2 In the **Settings** window for **Box Selection**, type Inlet Manifold in the **Label** text field.
- 3 Locate the **Box Limits** section. In the **x minimum** text field, type $-L_inout$.
- 4 In the **y maximum** text field, type $w_ch/2$.

5 Locate the **Output Entities** section. From the **Include entity if** list, choose **Entity inside box**.

6 Click  **Build Selected**.

Outlet Manifold

- 1 In the **Geometry** toolbar, click  **Selections** and choose **Box Selection**.
- 2 In the **Settings** window for **Box Selection**, type Outlet Manifold in the **Label** text field.
- 3 Locate the **Box Limits** section. In the **x maximum** text field, type $N_ch * w_ch * 2 + L_inout - w_ch$.
- 4 In the **y minimum** text field, type $L_ch - w_ch / 2$.
- 5 Locate the **Output Entities** section. From the **Include entity if** list, choose **Entity inside box**.

Channels Above Electrode Surface

- 1 In the **Geometry** toolbar, click  **Selections** and choose **Box Selection**.
- 2 In the **Settings** window for **Box Selection**, type Channels Above Electrode Surface in the **Label** text field.
- 3 Locate the **Box Limits** section. In the **y minimum** text field, type $-w_ch / 2$.
- 4 In the **y maximum** text field, type $L_ch + w_ch / 2$.
- 5 Locate the **Output Entities** section. From the **Include entity if** list, choose **Entity inside box**.

Electrode Surface

- 1 In the **Geometry** toolbar, click  **Selections** and choose **Box Selection**.
- 2 In the **Settings** window for **Box Selection**, type Electrode Surface in the **Label** text field.
- 3 Locate the **Geometric Entity Level** section. From the **Level** list, choose **Boundary**.
- 4 Locate the **Box Limits** section. In the **y minimum** text field, type $-w_ch / 2$.
- 5 In the **y maximum** text field, type $L_ch + w_ch / 2$.
- 6 In the **z maximum** text field, type $h_a / 2$.
- 7 Locate the **Output Entities** section. From the **Include entity if** list, choose **Entity inside box**.

Inlet



- 1 In the **Geometry** toolbar, click  **Selections** and choose **Box Selection**.
- 2 In the **Settings** window for **Box Selection**, type Inlet in the **Label** text field.

- 3 Locate the **Geometric Entity Level** section. From the **Level** list, choose **Boundary**.
- 4 Locate the **Box Limits** section. In the **x maximum** text field, type 0.
- 5 In the **z minimum** text field, type h_a^2 .
- 6 Locate the **Output Entities** section. From the **Include entity if** list, choose **Entity inside box**.



Outlet

- 1 In the **Geometry** toolbar, click  **Selections** and choose **Box Selection**.
- 2 In the **Settings** window for **Box Selection**, locate the **Geometric Entity Level** section.
- 3 From the **Level** list, choose **Boundary**.
- 4 In the **Label** text field, type Outlet.
- 5 Locate the **Box Limits** section. In the **x minimum** text field, type $N_{ch} * w_{ch}^2$.
- 6 In the **z minimum** text field, type h_a^2 .
- 7 Locate the **Output Entities** section. From the **Include entity if** list, choose **Entity inside box**.

Exterior Boundaries to Electrode Channels

- 1 In the **Geometry** toolbar, click  **Selections** and choose **Adjacent Selection**.
- 2 In the **Settings** window for **Adjacent Selection**, type Exterior Boundaries to Electrode Channels in the **Label** text field.
- 3 Locate the **Input Entities** section. Click  **Add**.
- 4 In the **Add** dialog box, select **Channels Above Electrode Surface** in the **Input selections** list.
- 5 Click **OK**.

Exterior Boundaries to Inlet Manifold



- 1 In the **Geometry** toolbar, click  **Selections** and choose **Adjacent Selection**.
- 2 In the **Settings** window for **Adjacent Selection**, type Exterior Boundaries to Inlet Manifold in the **Label** text field.
- 3 Locate the **Input Entities** section. Click  **Add**.
- 4 In the **Add** dialog box, select **Inlet Manifold** in the **Input selections** list.
- 5 Click **OK**.

Inlets to Electrode Channels



- 1 In the **Geometry** toolbar, click  **Selections** and choose **Intersection Selection**.
- 2 In the **Settings** window for **Intersection Selection**, type Inlets to Electrode Channels in the **Label** text field.

- 3 Locate the **Geometric Entity Level** section. From the **Level** list, choose **Boundary**.
- 4 Locate the **Input Entities** section. Click  **Add**.
- 5 In the **Add** dialog box, in the **Selections to intersect** list, choose **Exterior Boundaries to Electrode Channels** and **Exterior Boundaries to Inlet Manifold**.
- 6 Click **OK**.



Manifolds

- 1 In the **Geometry** toolbar, click  **Selections** and choose **Union Selection**.
- 2 In the **Settings** window for **Union Selection**, type Manifolds in the **Label** text field.
- 3 Locate the **Input Entities** section. Click  **Add**.
- 4 In the **Add** dialog box, in the **Selections to add** list, choose **Inlet Manifold** and **Outlet Manifold**.
- 5 Click **OK**.

Exterior Boundaries to Manifolds

- 1 In the **Geometry** toolbar, click  **Selections** and choose **Adjacent Selection**.
- 2 In the **Settings** window for **Adjacent Selection**, type Exterior Boundaries to Manifolds in the **Label** text field.
- 3 Locate the **Input Entities** section. Click  **Add**.
- 4 In the **Add** dialog box, select **Manifolds** in the **Input selections** list.
- 5 Click **OK**.

Inlets and Outlets to Electrode Channels

- 1 In the **Geometry** toolbar, click  **Selections** and choose **Intersection Selection**.
- 2 In the **Settings** window for **Intersection Selection**, type Inlets and Outlets to Electrode Channels in the **Label** text field.
- 3 Locate the **Geometric Entity Level** section. From the **Level** list, choose **Boundary**.
- 4 Locate the **Input Entities** section. Click  **Add**.
- 5 In the **Add** dialog box, in the **Selections to intersect** list, choose **Exterior Boundaries to Electrode Channels** and **Exterior Boundaries to Manifolds**.
- 6 Click **OK**.

Electrode Channels and Manifolds

- 1 In the **Geometry** toolbar, click  **Selections** and choose **Union Selection**.
- 2 In the **Settings** window for **Union Selection**, type Electrode Channels and Manifolds in the **Label** text field.

- 3 Locate the **Input Entities** section. Click **+ Add**.
- 4 In the **Add** dialog box, in the **Selections to add** list, choose **Inlet Manifold**, **Outlet Manifold**, and **Channels Above Electrode Surface**.
- 5 Click **OK**.

Exterior Boundaries to Outlet Manifold

- 1 In the **Geometry** toolbar, click  **Selections** and choose **Adjacent Selection**.
- 2 In the **Settings** window for **Adjacent Selection**, type Exterior Boundaries to Outlet Manifold in the **Label** text field.
- 3 Locate the **Input Entities** section. Click **+ Add**.
- 4 In the **Add** dialog box, select **Outlet Manifold** in the **Input selections** list.
- 5 Click **OK**.

Outlets from Electrode Channels

- 1 In the **Geometry** toolbar, click  **Selections** and choose **Intersection Selection**.
- 2 In the **Settings** window for **Intersection Selection**, type Outlets from Electrode Channels in the **Label** text field.
- 3 Locate the **Geometric Entity Level** section. From the **Level** list, choose **Boundary**.
- 4 Locate the **Input Entities** section. Click **+ Add**.
- 5 In the **Add** dialog box, in the **Selections to intersect** list, choose **Exterior Boundaries to Electrode Channels** and **Exterior Boundaries to Outlet Manifold**.
- 6 Click **OK**.