



Piezoelectric Tonpilz Transducer with a Prestressed Bolt

Introduction

A tonpiliz transducer, such as the one shown in [Figure 1](#), is used for relatively low frequency, high power sound emission. It is one of the popular transducer configurations for sonar applications. The transducer consists of piezoceramic rings stacked between a head mass and a tail mass which are connected by a central bolt. This example shows how to incorporate the effect of a pretension in the bolt for various levels of bolt preload. A constitutive model is set up in order to incorporate the prestress effects on the piezoelectric material of the rings. The bolt geometry is imported from the *Part Libraries*. The frequency response of the transducer is studied to determine structural and acoustic response of the device such as deformation, stresses, radiated power, sound pressure level, the transmitting voltage response (TVR) curve, and the directivity index (DI) of the sound beam.

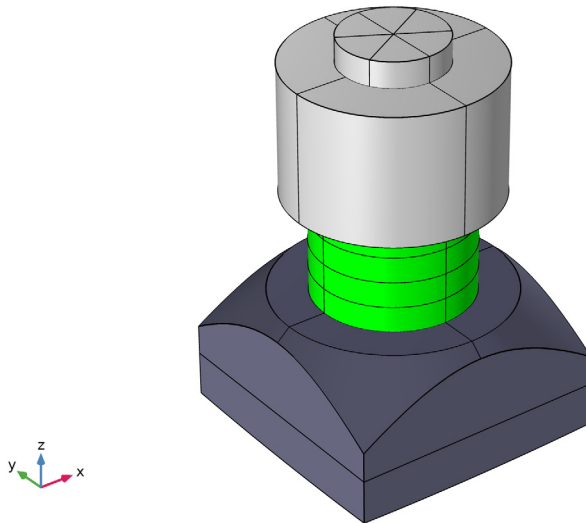

Figure 1: A tonpiliz transducer. The aluminum head mass is shown in dark gray, the central steel bolt and steel tail mass are shown in light gray and the piezostack actuator with four disks of PZT-4 is shown in green.

Note: This application requires both the Acoustics Module and the Structural Mechanics Module.

A similar version of this tutorial entitled [Piezoelectric Tonpilz Transducer](#), is available in the Application Libraries under Acoustics Module only. That version of the tutorial analyzes a slightly different geometry and does not implement the pretension in the bolt and hence does not require the Structural Mechanics Module. For additional details related to different customized settings and user-defined variables used in both the tonpilz transducer models, you are encouraged to read the documentation of the [Piezoelectric Tonpilz Transducer](#) tutorial.

Model Definition

The basic working principle involved in the operation of this transducer is that an AC electrical signal applied to the piezostack actuator produces vibration in the entire transducer which in turn produces sound waves in the surrounding fluid. Thus modeling the operation of the transducer requires coupling electrical, structural and acoustic phenomena.

In this tutorial we will particularly emphasize on the implementation of pretension in the central bolt of the transducer and associated solver settings that allow us to model the effect of prestress on the frequency response characteristics of the transducer.

The parameters used in this model are shown in [Table 1](#).

TABLE 1: LIST OF MODELING PARAMETERS.

NAME	EXPRESSION	DESCRIPTION
rho0	1000[kg/m ³]	Density of water
c0	1480[m/s]	Speed of sound in water
Zeval	-500[m]	Directivity evaluation distance
Vrms	1[V]	RMS drive voltage
V0	sqrt(2)*Vrms	Zero-to-peak drive voltage
f0min	30[kHz]	Minimum operating frequency
f0max	60[kHz]	Maximum operating frequency
f0step	0.5[kHz]	Frequency step
F_pre	3.1[kN]	Bolt pre-stress force
w_salinity	0.035	Salinity of the water
w_depth	500[m]	Depth of the water
eta_struct	0.01	Damping ratio of the structural components

PHYSICS IMPLEMENTATION

The *Pressure Acoustics, Boundary Elements* physics is used to solve for the wave equation in the water domain. The *Solid Mechanics* physics is solved on all structural materials including the PZT-4 disks. The *Electrostatics* physics is solved on the PZT-4 disks. The multiphysics couplings necessary to model this system are available as predefined nodes under the **Multiphysics** node. These couplings are:

Acoustic-Structure Boundary: This node is active on the boundaries that are at the interface of the water domain and transducer head mass. On these boundaries a bidirectional coupling is automatically set up. The fluid pressure evaluated by the Pressure Acoustics, Boundary Elements physics is applied as a mechanical load in the Solid Mechanics physics. Furthermore, the normal component of the structural acceleration is used as a sound source.

Piezoelectric Effect: This node is active on the PZT-4 domains only and couple the Solid Mechanics and Electrostatics equations solved in these domains via the linear constitutive equations that model the piezoelectric effect by coupling stresses and strains with electric field and electric displacement.

BOUNDARY SETTINGS

The outer curved surface of the steel tail mass has a *Spring Foundation* condition applied, with a total spring constant of 10000 [N/m]. This means that the transducer is effectively on a free condition in its operation range, as the spring foundation leaves the translational modes below 100 [Hz]. Each of the piezo disks are excited with a 1 V RMS electrical signal.

The head mass is exposed to a semi-infinite region of water represented by the *Pressure Acoustics, Boundary Elements* physics. Losses in the fluid domain are included using the built-in Ocean Attenuation available.

The *Pressure Acoustics, Boundary Elements* physics allows computation of both amplitude and phase of the acoustic pressure and sound pressure level (SPL) at any point in the semi-infinite space. This pressure is used to compute the TVR and DI.

The user-defined variables used to compute the transducer characteristics are shown in Table 2.

TABLE 2: LIST OF VARIABLES.

NAME	EXPRESSION	DESCRIPTION
Zaco	$\text{intop1}(p)/\text{intop1}(pabe.i\omega*(w+\epsilon))/(\rho_0*c_0)$	Specific acoustic impedance
pext_l	$\text{at3_spatial}(0,0,-l[m],pabe.p_t,'minc')$	Acoustic pressure at l m
prms	$\text{sqrt}(0.5*pext_l*conj(pext_l))$	RMS pressure at l m
TVR	$20*\log_{10}(prms/Vrms/l[\text{uPa/V}])$	Transmitting Voltage Response (TVR)
pext_Zeval	$\text{at3_spatial}(0,0,-Zeval,pabe.p_t,'minc')$	Acoustic pressure at Zeval
lfront	$0.5*pext_Zeval*conj(pext_Zeval)[\text{Pa}^2]/(\rho_0*c_0)$	On-axis intensity at Zeval
Ptot	$-\text{intop1}(pabe.l_bndx*pabe.nx+pabe.l_bndy*pabe.ny+pabe.l_bndz*pabe.nz)$	Total radiated power
lave	$Ptot/(4*\pi*Zeval^2)$	Average intensity of monopole source at Zeval
Di	$lfront/lave$	Intensity directivity
DI	$10*\log_{10}(Di)$	Directivity index of Tonpilz transducer
k0	$2*\pi*freq/c_0$	Wave number
pzt_stress	$F_pre/\text{intop2}(l)$	Nominal compressive stress at the PZT

MODELING A BOLT WITH PRETENSION

When a bolt is mounted on a device to clamp the components, it is tightened by twisting the bolt head. As a reaction to the tightening process, a pretension force is experienced by the bolt. This force produces a prestress that helps to hold the bolt in place during regular operation of the device. This also ensures that when additional stresses develop in the bolt during operation of the device, it should not become loose. Note that the tightening of the bolt also produces stresses in the surrounding components, including the piezoelectric material. This is why accounting for the pretension force in the bolt would give us an accurate picture of the prestress distribution not only in the bolt but also in the entire device.

The piezoelectric properties are usually altered when the material is stressed, varying the value of some of the piezoelectric constants as the stress value changes. For this purpose a

constitutive model is used. The form of the model is based on experimental results. This model uses an approach similar to the one described in Ref. 1, where the piezoelectric constants of the material depend on the nominal pretension stress at the piezoelectric material, as defined in Equation 1.

$$\sigma_{pzt} = \frac{F_{pre}}{A_{pzt}} \quad (1)$$

In Equation 1 σ_{pzt} is the nominal pretension stress at the piezoelectric material, F_{pre} is the Bolt pre-stress force and A_{pzt} is the area of the piezoelectric material perpendicular to the bolt axis.

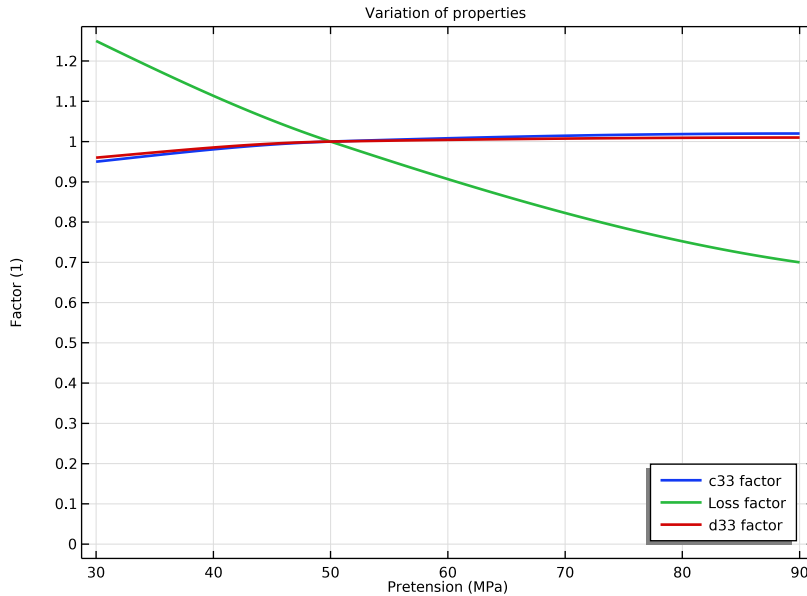

Figure 2: Variation of the piezoelectric constants as a function of the nominal pretension stress. The values are normalized at a pretension stress of 50 MPa.

Figure 2 shows the variation of the piezoelectric properties of the material as a function of the nominal pretension stress of the piezoelectric material. The values shown in this curve are generic and included in the model as an example.

COMSOL's *Structural Mechanics Module* provides a *Bolt Pretension* feature that can be used to implement a desired pretension or prestress in bolted joints. You can import the

bolt geometry from the *Part Libraries*. These bolt geometries are created in a certain way so that we can directly use the Bolt Pretension feature on them. In order to use this feature, there should be a cross section surface passing through the shank of the bolt. This surface needs to be associated with the Bolt Selection subnode under the Bolt Pretension node. COMSOL sets up an additional equation for each bolt that computes the pre-deformation of the bolt, the pretension force as well as the shear force in the bolt. For example, in this model, on application of 3.1 kN pretension, we get a pre-deformation of 37 μm .

Note that the deformation along the longitudinal axis of the bolt is discontinuous at the surface assigned to the Bolt Selection subnode but the stresses and strains are continuous. For more details on implementation of the Bolt Pretension feature, you can refer to the section on *Modeling Pretensioned Bolts* in the *Structural Mechanics Module User's Guide*.

As a result of the prestress in the device, if we want to solve a vibrations problem in frequency domain, we need to account for the fact that the harmonic variation of stress and other physical quantities during vibration takes place on top of the static bias stress. Hence we need to solve this model using a two-step approach where the first step involves solving for the static stress distribution using a **Stationary** study step. The solution from this step is then used as a linearization point for solving the vibration problem in the **Frequency Domain Perturbation** study step.

Note that this workflow is valid only for small perturbations about the static solution. Hence we should only use this technique if the magnitude of the stress and other physical quantities from the frequency domain problem is significantly smaller than the magnitude of the same quantities obtained from the static problem.

The AC voltage signal applied to the piezostack actuator is specified using the `linper()` operator. This operator ensures that the numerical input is used only in the **Frequency Domain Perturbation** step and not in the **Stationary** step when solving the model. Furthermore, when solving the vibrations problem in frequency domain, you only want to account for the stress generated in the device as a result of its operation and hence you do not want to solve the pre-deformation variable in the bolt. This is ensured by using the **Frequency Domain Perturbation** study step.

Results and Discussion

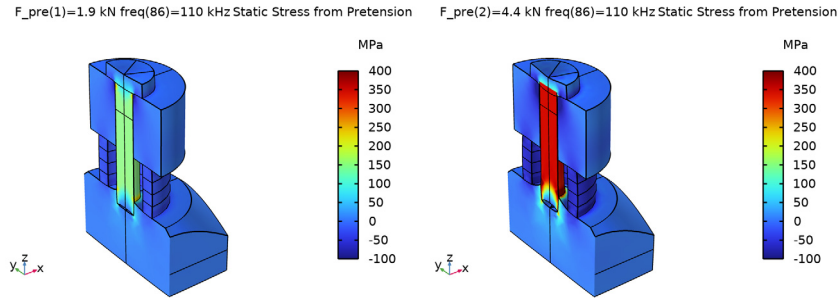

Figure 3: Static z-component of the stress in the transducer for two levels of pretension. An exaggerated deformation has been used for better visualization.

Figure 3 shows the z-component of the static stress in the transducer for two levels of bolt pretension. The stress is fairly uniform in the shank of the bolt. Note that the largest stress appears mainly in the shank of the bolt and in the central part of the aluminum head mass which is located directly below the bolt.

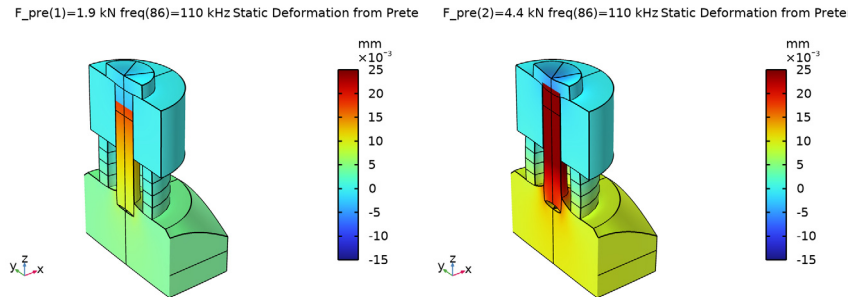

Figure 4: Static displacement of the transducer for different levels of pretension. An exaggerated deformation has been used for better visualization.

Figure 4 shows the z-component of the static displacement in the transducer for three levels of bolt pretension. Note the discontinuity of displacements through the shank of the

bolt and the small displacement around the tail mass due to the *Spring Foundation* boundary condition.

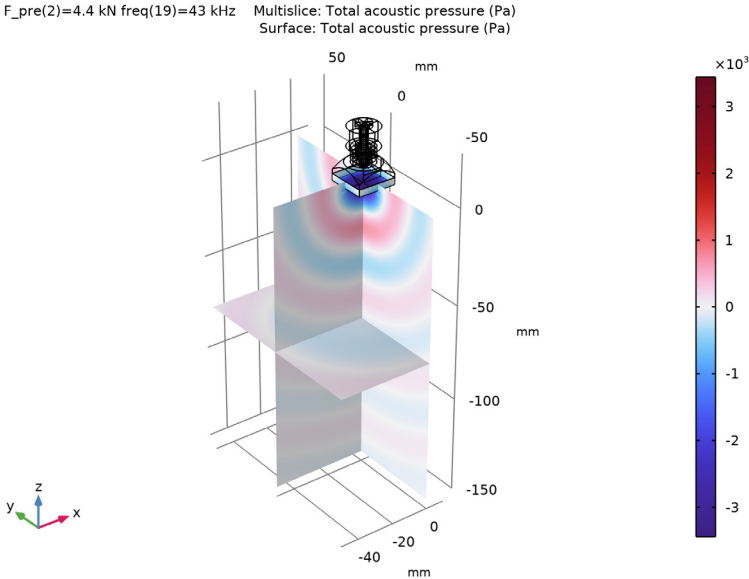

Figure 5: Slice plot of the total acoustic pressure in the water domain at 43 kHz for a pretension of 4.4 kN.

Figure 5 shows the total acoustic pressure in the water domain for 43 kHz excitation. Note that the transducer behaves mostly as an omni directional sound at this frequency.

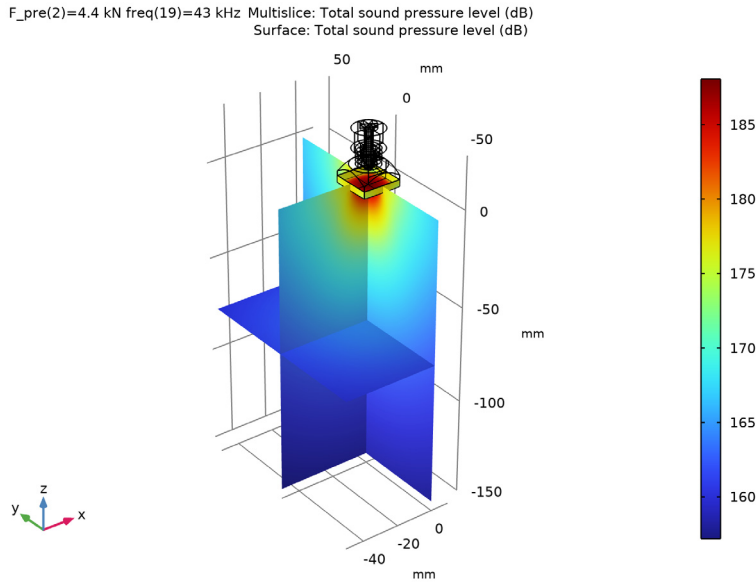

Figure 6: Slice plot showing the variation in sound pressure level (in dB) in the water domain at 43 kHz for a pretension of 4.4 kN.

Figure 5 shows the sound pressure level (SPL) in the water domain for 43 kHz excitation. The SPL is highest near the transducer head mass. The variation in the SPL around the transducer would depend on the operating frequency and the dominant mode in which the transducer vibrates.

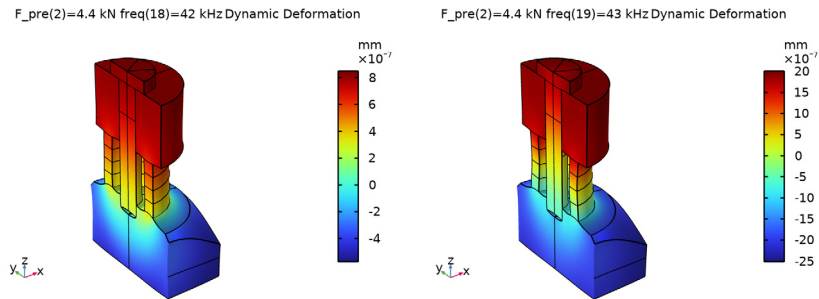

Figure 7: Variation in the dynamic displacement of the transducer between 42 kHz and 43 kHz for a pretension of 4.4 kN.

Figure 7 shows the dynamic deformation and vertical displacement of the tonpilz transducer at 43 kHz and 44 kHz excitation. The sudden change in the deformed shape for these two close frequencies indicates a structural mode. The head mass vibrates mainly along its axis similar to a flanged piston.

F_pre(2)=4.4 kN freq(86)=110 kHz Volume: Electric potential (V)

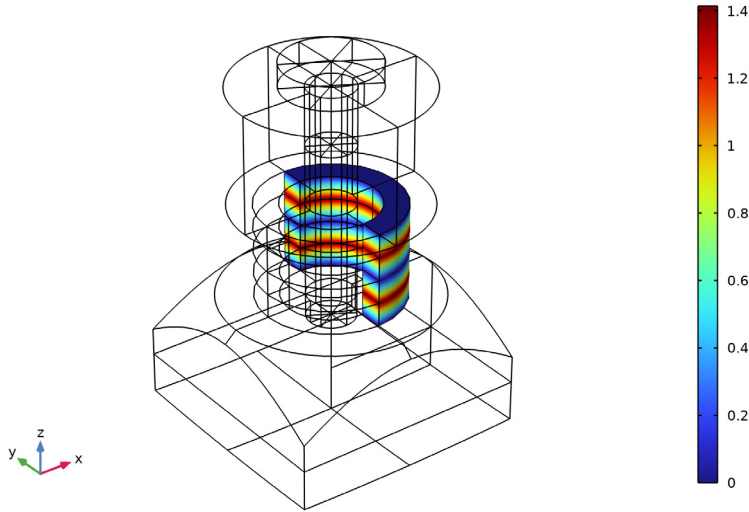

Figure 8: Electric potential distribution within the four PZT-4 disks.

Figure 8 shows the electric potential distribution through the thickness of the PZT-4 disks. The piezoelectric disks are stacked in a way such that alternate disks are poled along opposite directions. This allows us to use a single electrical terminal at the interface of each pair of disks and obtain the piezoelectric actuation effect in each of the disks along the same direction. Having the piezoelectric strain in-phase in all the disks maximizes the actuation.

In this model, the PZT-4 disks actuate in the d_{33} -mode. Hence two of the disks are poled along the $+Z$ direction while the other two are poled along the $-Z$ direction. The default definition of the piezoelectric material properties in COMSOL's **Global Coordinate System** automatically creates a $+Z$ polarization. In order to create a $-Z$ polarization, a user-defined **Rotated Coordinate System** is used. In this coordinate system, the Euler angles are set to $\alpha = 0$, $\beta = \pi$ and $\gamma = 0$.

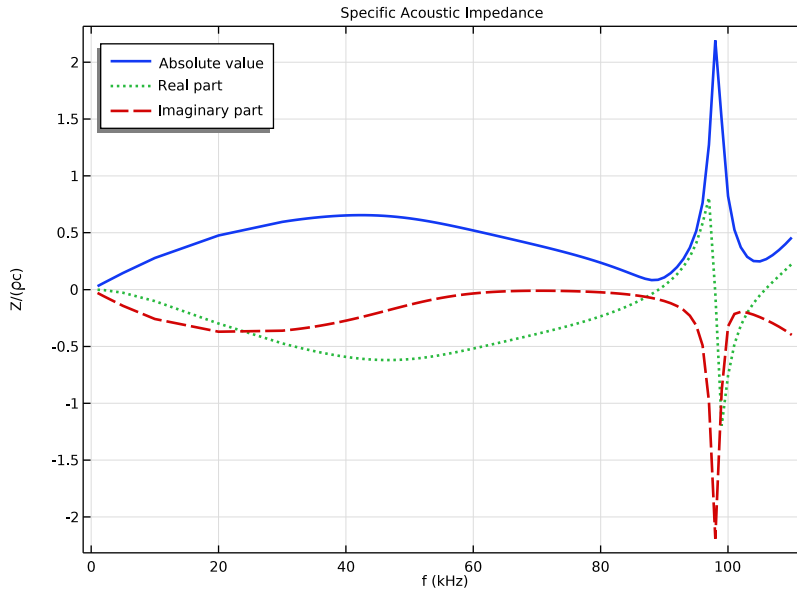

Figure 9: Frequency response plot of the absolute value, real and imaginary components of the specific acoustic impedance at the interface between the head mass and water for a pretension of 3.1 kN.

Figure 9 shows the frequency response of the specific acoustic impedance of the head mass surface that is exposed to water.

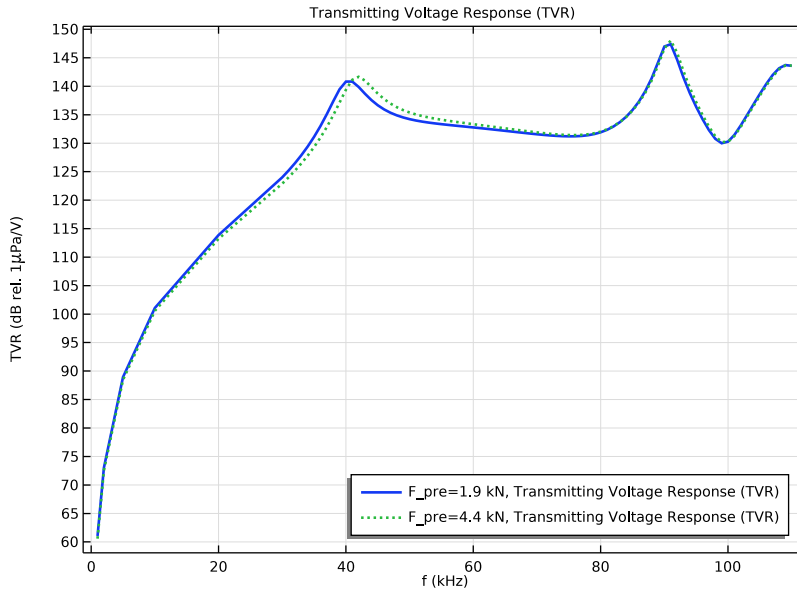

Figure 10: Transmitting Voltage Response (TVR) as a function of frequency obtained at an on-axis distance of 1 m ahead of the head mass and computed relative to 1 $\mu\text{Pa}/\text{V}$ for two levels of bolt pretension.

Figure 10 shows the variation in the TVR of the transducer as a function of operating frequency. The fairly flat region above 30 kHz can be particularly useful for sensing applications.

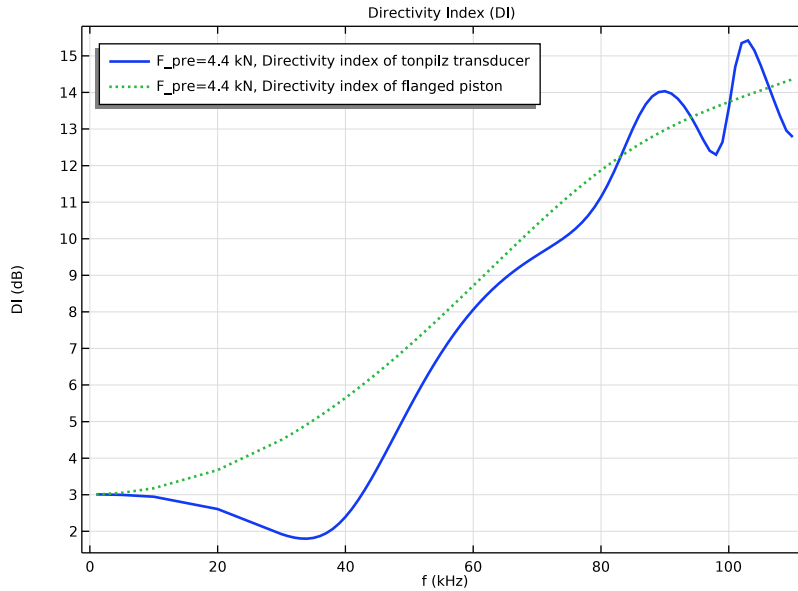

Figure 11: Frequency response of the Directivity Index (DI) computed at an on-axis distance of 500 m from the head mass.

Figure 11 shows the Directivity Index (DI) of the tonpilz transducer (blue curve) and compares it with the DI of a flanged piston (green curve). The latter can be computed from analytical expression as shown in Table 2. It is defined by the variable DI_{fl_pist} . Note that the DI is very similar to that of a flanged piston for most of the frequency range.

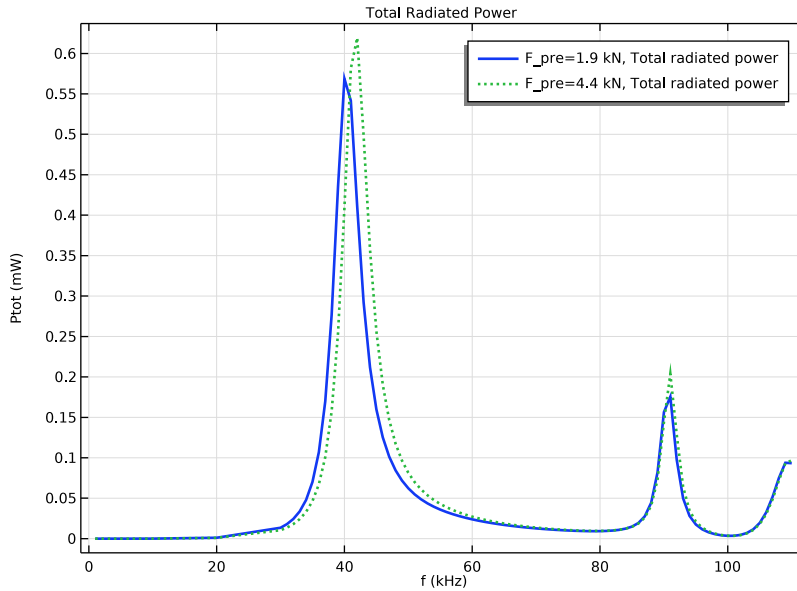

Figure 12: Total radiated power from the tonpilz transducer within the operating frequency range of 1 kHz to 110 kHz for the two levels of bolt pretension.

Figure 12 shows the total radiated power as a function of the operating frequency of the tonpilz transducer. Note that the modification of the piezoelectric properties with the pretension is reflected in the frequency at which the maximum power is produced and also in the shape of the curve.

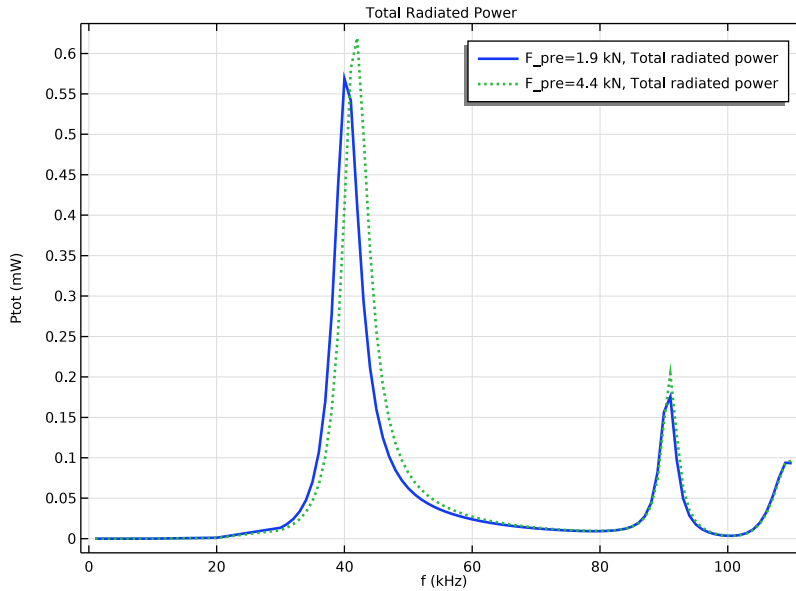

Figure 13: Absolute electric impedance and its angle for the two levels of bolt pretension.

Figure 13 shows the absolute electric impedance and its angle for the two levels of bolt pretension. The two main resonances are quite clear due to the sudden change of the electric impedance angle.

References

1. Bo Fu ; Ting Li ; Yongle Xie, “Model-Based Diagnosis for Pre-Stress of Langevin Transducers” *IEEE Circuits and Systems International Conference on Testing and Diagnosis*, 2009.

Application Library path: Acoustics_Module/Piezoelectric_Devices/
tonpilz_transducer_pre stressed



Modeling Instructions

From the **File** menu, choose **New**.

NEW

In the **New** window, click  **Model Wizard**.

MODEL WIZARD

- 1 In the **Model Wizard** window, click  **3D**.
- 2 In the **Select Physics** tree, select **Acoustics>Pressure Acoustics>Pressure Acoustics, Boundary Elements (pabe)**.
- 3 Click **Add**.
- 4 In the **Select Physics** tree, select **Structural Mechanics>Electromagnetics-Structure Interaction>Piezoelectricity>Piezoelectricity, Solid**.
- 5 Click **Add**.
- 6 Click  **Study**.
- 7 In the **Select Study** tree, select **Preset Studies for Some Physics Interfaces>Bolt Pretension**.
- 8 Click  **Done**.

GEOMETRY I

- 1 In the **Model Builder** window, under **Component 1 (comp1)** click **Geometry 1**.
- 2 In the **Settings** window for **Geometry**, locate the **Units** section.
- 3 From the **Length unit** list, choose **mm**.
Import the file containing the model parameters.

GLOBAL DEFINITIONS

Parameters 1

- 1 In the **Model Builder** window, under **Global Definitions** click **Parameters 1**.
- 2 In the **Settings** window for **Parameters**, locate the **Parameters** section.
- 3 Click  **Load from File**.
- 4 Browse to the model's Application Libraries folder and double-click the file `tonpilz_transducer_prestressed_parameters.txt`.

GEOMETRY I

Work Plane 1 (wp1)

1 In the **Geometry** toolbar, click  **Work Plane**.

The modeling geometry is created by first drawing the cross section on a work plane and then revolving this cross section to get the 3-dimensional geometry. The central bolt in the transducer is later added from the Part Libraries.

2 In the **Settings** window for **Work Plane**, locate the **Plane Definition** section.

3 From the **Plane** list, choose **xz-plane**.

4 Click  **Show Work Plane**.

Work Plane 1 (wp1)>Rectangle 1 (r1)

1 In the **Work Plane** toolbar, click  **Rectangle**.

2 In the **Settings** window for **Rectangle**, locate the **Size and Shape** section.

3 In the **Width** text field, type 6[mm].

4 In the **Height** text field, type 10[mm].

5 Locate the **Position** section. In the **xw** text field, type 2[mm].

6 In the **yw** text field, type 15[mm].

Work Plane 1 (wp1)>Rectangle 2 (r2)

1 In the **Work Plane** toolbar, click  **Rectangle**.

2 In the **Settings** window for **Rectangle**, locate the **Size and Shape** section.

3 In the **Width** text field, type 2[mm].

4 In the **Height** text field, type 8[mm].

5 Locate the **Position** section. In the **xw** text field, type 4[mm].

6 In the **yw** text field, type 7[mm].

7 Click to expand the **Layers** section. In the table, enter the following settings:

Layer name	Thickness (mm)
Layer 1	2
Layer 2	2
Layer 3	2

Work Plane 1 (wp1)>Polygon 1 (pol1)

1 In the **Work Plane** toolbar, click  **Polygon**.

2 In the **Settings** window for **Polygon**, locate the **Coordinates** section.

3 In the table, enter the following settings:

xw (mm)	yw (mm)
0	-5 [mm]
0	5 [mm]
2 [mm]	5 [mm]
2 [mm]	7 [mm]
9 [mm]	7 [mm]
20 [mm]	-3 [mm]

Work Plane 1 (wp1)>Quadratic Bézier 1 (qbl)

- 1 In the **Work Plane** toolbar, click  **More Primitives** and choose **Quadratic Bézier**.
- 2 In the **Settings** window for **Quadratic Bézier**, locate the **Control Points** section.
- 3 In row **1**, set **xw** to -20 [mm].
- 4 In row **1**, set **yw** to -3 [mm].
- 5 In row **2**, set **yw** to -5 [mm].
- 6 In row **3**, set **xw** to 20 [mm].
- 7 In row **3**, set **yw** to -3 [mm].

Work Plane 1 (wp1)>Union 1 (uni1)

- 1 In the **Work Plane** toolbar, click  **Booleans and Partitions** and choose **Union**.
- 2 Select the objects **pol1** and **qbl** only.

Work Plane 1 (wp1)>Delete Entities 1 (del1)

- 1 In the **Model Builder** window, right-click **Plane Geometry** and choose **Delete Entities**.
- 2 On the object **uni1**, select Boundaries 1, 2, and 8 only.
- 3 In the **Settings** window for **Delete Entities**, click  **Build Selected**.

Revolve 1 (rev1)

In the **Model Builder** window, under **Component 1 (comp1)>Geometry 1** right-click **Work Plane 1 (wp1)** and choose **Revolve**.



Block 1 (blk1)

- 1 In the **Geometry** toolbar, click  **Block**.
- 2 In the **Settings** window for **Block**, locate the **Size and Shape** section.
- 3 In the **Width** text field, type 20 [mm].
- 4 In the **Depth** text field, type 20 [mm].

- 5 In the **Height** text field, type 60 [mm].
- 6 Locate the **Position** section. From the **Base** list, choose **Center**.
- 7 Click to expand the **Layers** section. In the table, enter the following settings:

Layer name	Thickness (mm)
Layer 1	30 [mm]

Intersection 1 (int1)

- 1 In the **Geometry** toolbar, click  **Booleans and Partitions** and choose **Intersection**.
- 2 Click in the **Graphics** window and then press Ctrl+A to select both objects.
- 3 In the **Settings** window for **Intersection**, click  **Build Selected**.
Create domain and boundary selections that will be used in the model.

Aluminum

- 1 In the **Geometry** toolbar, click  **Selections** and choose **Explicit Selection**.
- 2 In the **Settings** window for **Explicit Selection**, type Aluminum in the **Label** text field.
- 3 On the object **int1**, select Domains 1 and 2 only.

Steel Part

- 1 In the **Geometry** toolbar, click  **Selections** and choose **Explicit Selection**.
- 2 In the **Settings** window for **Explicit Selection**, type Steel Part in the **Label** text field.
- 3 On the object **int1**, select Domain 3 only.
- 4 Locate the **Resulting Selection** section. Clear the **Keep selection** check box.
- 5 Find the **Cumulative selection** subsection. Click **New**.
- 6 In the **New Cumulative Selection** dialog box, type Steel in the **Name** text field.
- 7 Click **OK**.

+Z poled Piezo

- 1 In the **Geometry** toolbar, click  **Selections** and choose **Explicit Selection**.
- 2 In the **Settings** window for **Explicit Selection**, type +Z poled Piezo in the **Label** text field.

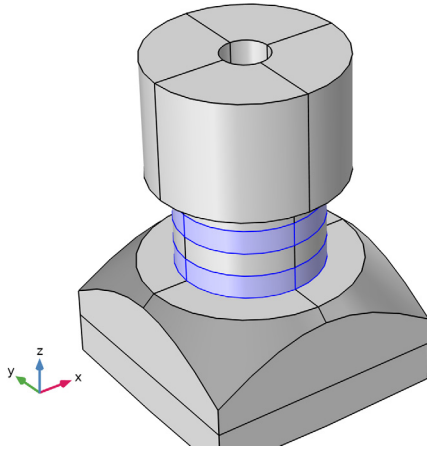

- 3 On the object **int1**, select Domains 4 and 6 only.
The selection should look like this.



-Z poled Piezo

- 1 In the **Geometry** toolbar, click  **Selections** and choose **Explicit Selection**.
- 2 In the **Settings** window for **Explicit Selection**, type -Z poled Piezo in the **Label** text field.
- 3 On the object **int1**, select Domains 5 and 7 only.

Ground boundaries

- 1 In the **Geometry** toolbar, click  **Selections** and choose **Explicit Selection**.
- 2 In the **Settings** window for **Explicit Selection**, type Ground boundaries in the **Label** text field.
- 3 Locate the **Entities to Select** section. From the **Geometric entity level** list, choose **Boundary**.
- 4 Click the  **Wireframe Rendering** button in the **Graphics** toolbar.

- 5 On the object **int1**, select Boundaries 22, 23, 30, 31, 36, 37, 63, 67, 70, 90, 94, and 97 only.

The selection should look like this.

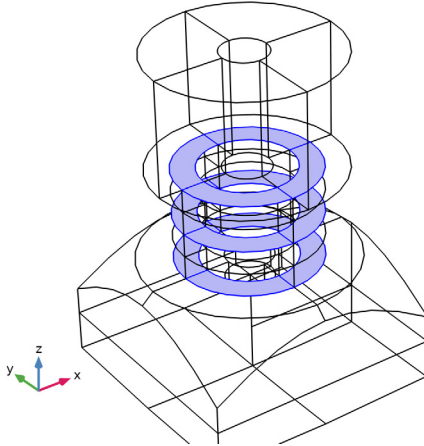

Voltage boundaries

- 1 In the **Geometry** toolbar, click  **Selections** and choose **Explicit Selection**.
- 2 In the **Settings** window for **Explicit Selection**, type Voltage boundaries in the **Label** text field.
- 3 Locate the **Entities to Select** section. From the **Geometric entity level** list, choose **Boundary**.
- 4 On the object **int1**, select Boundaries 26, 27, 34, 35, 65, 69, 92, and 96 only.

Submerged boundaries

- 1 In the **Geometry** toolbar, click  **Selections** and choose **Explicit Selection**.
- 2 In the **Settings** window for **Explicit Selection**, type Submerged boundaries in the **Label** text field.
- 3 Locate the **Entities to Select** section. From the **Geometric entity level** list, choose **Boundary**.
- 4 On the object **int1**, select Boundaries 1–3, 8, 10, 56, 81, 111, and 113 only.

Spring foundation boundaries

- 1 In the **Geometry** toolbar, click  **Selections** and choose **Explicit Selection**.



- 2 In the **Settings** window for **Explicit Selection**, type Spring foundation boundaries in the **Label** text field.
- 3 Locate the **Entities to Select** section. From the **Geometric entity level** list, choose **Boundary**.
- 4 On the object **int1**, select Boundaries 14, 15, 59, and 104 only.

Piezo Domains

- 1 In the **Geometry** toolbar, click  **Selections** and choose **Explicit Selection**.
- 2 In the **Settings** window for **Explicit Selection**, type Piezo Domains in the **Label** text field.
- 3 On the object **int1**, select Domains 4–7 only.

The CAD geometry of a simple bolt with no thread is imported from the Part Libraries. The design parameters of the bolt are adjusted to position the bolt in the tonpilz transducer.

PART LIBRARIES

- 1 In the **Geometry** toolbar, click  **Parts** and choose **Part Libraries**.
- 2 In the **Part Libraries** window, select **Structural Mechanics Module>Bolts>simple_bolt_no_thread** in the tree.
- 3 Click  **Add to Geometry**.

GEOMETRY 1

Simple Bolt, No Thread 1 (pi1)

- 1 In the **Model Builder** window, under **Component 1 (comp1)>Geometry 1** click **Simple Bolt, No Thread 1 (pi1)**.
- 2 In the **Settings** window for **Part Instance**, locate the **Input Parameters** section.
- 3 In the table, enter the following settings:

Name	Expression	Value	Description
hdia	8 [mm]	8 mm	Head diameter
hthc	2 [mm]	2 mm	Head thickness
ndia	4 [mm]	4 mm	Nominal diameter
blen	20 [mm]	20 mm	Bolt length

- 4 Locate the **Position and Orientation of Output** section. Find the **Coordinate system in part** subsection. From the **Work plane in part** list, choose **Head inner plane (wp1)**.
- 5 Find the **Displacement** subsection. In the **zw** text field, type 25.

6 Click to expand the **Domain Selections** section. In the table, enter the following settings:

Name	Keep	Physics	Contribute to
All		√	Steel



7 Click to expand the **Boundary Selections** section. In the table, enter the following settings:

Name	Keep	Physics	Contribute to
Exterior		√	None
Shank		√	None
Head, free surface		√	None
Head, contact surface		√	None
Pretension cut	√	√	None

8 Click  **Build Selected**.

The geometry finalization method is changed to Form an Assembly to ensure that the bolt is not glued or rigidly attached to the adjacent parts.

Excluded BEM boundaries

- 1 In the **Geometry** toolbar, click  **Selections** and choose **Complement Selection**.
- 2 In the **Settings** window for **Complement Selection**, type Excluded BEM boundaries in the **Label** text field.
- 3 Locate the **Geometric Entity Level** section. From the **Level** list, choose **Boundary**.
- 4 Locate the **Input Entities** section. Click  **Add**.
- 5 In the **Add** dialog box, select **Submerged boundaries** in the **Selections to invert** list.
- 6 Click **OK**.

Form Union (fin)

- 1 In the **Model Builder** window, under **Component 1 (comp1)>Geometry 1** click **Form Union (fin)**.
- 2 In the **Settings** window for **Form Union/Assembly**, locate the **Form Union/Assembly** section.
- 3 From the **Action** list, choose **Form an assembly**.
- 4 Select the **Create imprints** check box.
- 5 In the **Geometry** toolbar, click  **Build All**.

An Identity Pair is used to get continuity in solution between the external surfaces of the bolt and the surfaces of other materials touching them. This continuity in solution

is applicable for the lower end of the shank that is bolted into the aluminum head mass and the lower surface of the bolt head which is resting on the steel tail mass. The outer surface of the shank should be allowed to slip through the hole in the tail mass. Hence those boundaries need to be removed from the Identity Pair by modifying the default Identity Pair that has been created.

Source Boundaries

- 1 In the **Geometry** toolbar, click  **Selections** and choose **Explicit Selection**.
- 2 In the **Settings** window for **Explicit Selection**, type **Source Boundaries** in the **Label** text field.
- 3 Locate the **Entities to Select** section. From the **Geometric entity level** list, choose **Boundary**.
- 4 On the object **fin**, select Boundaries 144, 145, 148, 153, 155, 156, 166, 176, 186, 189, 215, 219, 221, 225, 226, and 229 only.

Destination Boundaries

- 1 In the **Geometry** toolbar, click  **Selections** and choose **Explicit Selection**.
- 2 In the **Settings** window for **Explicit Selection**, type **Destination Boundaries** in the **Label** text field.
- 3 Locate the **Entities to Select** section. From the **Geometric entity level** list, choose **Boundary**.
- 4 On the object **fin**, select Boundaries 50–55, 62, 66, 91, 92, 102, 107, 126, 129, 130, and 133 only.

DEFINITIONS

Identity Boundary Pair 1 (ap1)



- 1 In the **Model Builder** window, under **Component 1 (comp1)>Definitions** click **Identity Boundary Pair 1 (ap1)**.
- 2 In the **Settings** window for **Pair**, locate the **Pair Type** section.
- 3 Select the **Manual control of selections and pair type** check box.
- 4 Locate the **Source Boundaries** section. From the **Selection** list, choose **Source Boundaries**.
- 5 Locate the **Destination Boundaries** section. From the **Selection** list, choose **Destination Boundaries**.

Integration 1 (intop1)



- 1 In the **Definitions** toolbar, click  **Nonlocal Couplings** and choose **Integration**.
Define a nonlocal integration coupling on the acoustic-structure interface.

- 2 In the **Settings** window for **Integration**, locate the **Source Selection** section.
- 3 From the **Geometric entity level** list, choose **Boundary**.
- 4 From the **Selection** list, choose **Submerged boundaries**.

Integration 2 (intop2)

- 1 In the **Definitions** toolbar, click  **Nonlocal Couplings** and choose **Integration**.
This integral is only used to compute the nominal stress of the piezoelectric material.
- 2 In the **Settings** window for **Integration**, locate the **Source Selection** section.
- 3 From the **Geometric entity level** list, choose **Boundary**.
- 4 Click  **Paste Selection**.
- 5 In the **Paste Selection** dialog box, type 36 37 84 116 in the **Selection** text field.
- 6 Click **OK**.

Integration 3 (intop3)

- 1 In the **Definitions** toolbar, click  **Nonlocal Couplings** and choose **Integration**.
This integral is used to compute the equivalent area of a flanged piston
- 2 In the **Settings** window for **Integration**, locate the **Source Selection** section.
- 3 From the **Geometric entity level** list, choose **Boundary**.
- 4 Click  **Paste Selection**.
- 5 In the **Paste Selection** dialog box, type 6 in the **Selection** text field.
- 6 Click **OK**.
Proceed to define the relationship between the different properties of the piezoelectric material and the nominal stress.

c33 factor

- 1 In the **Definitions** toolbar, click  **Interpolation**.
- 2 In the **Settings** window for **Interpolation**, type *c33 factor* in the **Label** text field.
- 3 Locate the **Definition** section. In the **Function name** text field, type *c33_factor*.
- 4 In the table, enter the following settings:

t	f(t)
30	0.95
50	1
90	1.02

- 5 Locate the **Interpolation and Extrapolation** section. From the **Interpolation** list, choose **Piecewise cubic**.
- 6 Locate the **Units** section. In the **Arguments** text field, type MPa.
- 7 In the **Function** text field, type 1.

Loss factor

- 1 In the **Definitions** toolbar, click  **Interpolation**.
- 2 In the **Settings** window for **Interpolation**, type Loss factor in the **Label** text field.
- 3 Locate the **Definition** section. In the **Function name** text field, type loss_factor.
- 4 In the table, enter the following settings:

t	f(t)
30	1.25
50	1
90	0.7

- 5 Locate the **Interpolation and Extrapolation** section. From the **Interpolation** list, choose **Piecewise cubic**.
- 6 Locate the **Units** section. In the **Arguments** text field, type MPa.
- 7 In the **Function** text field, type 1.

d33 factor

- 1 In the **Definitions** toolbar, click  **Interpolation**.
- 2 In the **Settings** window for **Interpolation**, type d33 factor in the **Label** text field.
- 3 Locate the **Definition** section. In the **Function name** text field, type d33_factor.
- 4 In the table, enter the following settings:

t	f(t)
30	0.96
50	1
90	1.01

- 5 Locate the **Interpolation and Extrapolation** section. From the **Interpolation** list, choose **Piecewise cubic**.
- 6 Locate the **Units** section. In the **Arguments** text field, type MPa.
- 7 In the **Function** text field, type 1.

Variables 1

1 In the **Definitions** toolbar, click  **Local Variables**.

Import the file containing the variable definitions. These variables will mainly be used for postprocessing calculations.

2 In the **Settings** window for **Variables**, locate the **Variables** section.

3 Click  **Load from File**.

4 Browse to the model's Application Libraries folder and double-click the file `tonpilz_transducer_prestressed_variables.txt`.

ADD MATERIAL

1 In the **Home** toolbar, click  **Add Material** to open the **Add Material** window.

2 Go to the **Add Material** window.

3 In the tree, select **Built-in>Water, liquid**.

4 Click  **Add to Component I (comp1)**.

5 In the tree, select **Built-in>Aluminum**.

6 Click  **Add to Component I (comp1)**.

7 In the tree, select **Built-in>Steel AISI 4340**.

8 Click  **Add to Component I (comp1)**.

9 In the tree, select **Piezoelectric>Lead Zirconate Titanate (PZT-4)**.

10 Click  **Add to Component I (comp1)**.

11 In the **Home** toolbar, click  **Add Material** to close the **Add Material** window.

MATERIALS

Water, liquid (mat1)

1 In the **Settings** window for **Material**, locate the **Geometric Entity Selection** section.

2 From the **Selection** list, choose **All voids**.

Aluminum (mat2)

1 In the **Model Builder** window, click **Aluminum (mat2)**.

2 In the **Settings** window for **Material**, locate the **Geometric Entity Selection** section.

3 From the **Selection** list, choose **Aluminum**.

Steel AISI 4340 (mat3)

1 In the **Model Builder** window, click **Steel AISI 4340 (mat3)**.

2 In the **Settings** window for **Material**, locate the **Geometric Entity Selection** section.

3 From the **Selection** list, choose **Steel**.

Lead Zirconate Titanate (PZT-4) (mat4)

1 In the **Model Builder** window, click **Lead Zirconate Titanate (PZT-4) (mat4)**.

2 In the **Settings** window for **Material**, locate the **Geometric Entity Selection** section.

3 From the **Selection** list, choose **Piezo Domains**.

PRESSURE ACOUSTICS, BOUNDARY ELEMENTS (PABE)

1 In the **Model Builder** window, under **Component 1 (comp1)** click **Pressure Acoustics, Boundary Elements (pabe)**.

2 In the **Settings** window for **Pressure Acoustics, Boundary Elements**, locate the **Domain Selection** section.

3 From the **Selection** list, choose **All voids**.

4 Locate the **Sound Pressure Level Settings** section. From the **Reference pressure for the sound pressure level** list, choose **Use reference pressure for water**.

5 Click to expand the **Symmetry/Infinite Boundary Condition** section. From the **Condition for the $z = z^0$ plane** list, choose **Symmetric/Infinite sound hard boundary**.

Excluded Boundary 1

1 In the **Physics** toolbar, click  **Boundaries** and choose **Excluded Boundary**.

2 In the **Settings** window for **Excluded Boundary**, locate the **Boundary Selection** section.

3 From the **Selection** list, choose **Excluded BEM boundaries**.

Pressure Acoustics 1

1 In the **Model Builder** window, click **Pressure Acoustics 1**.

2 In the **Settings** window for **Pressure Acoustics**, locate the **Pressure Acoustics Model** section.

3 From the **Fluid model** list, choose **Ocean attenuation**.

4 Locate the **Model Input** section. In the D text field, type `w_depth`.

SOLID MECHANICS (SOLID)

Piezoelectric Material 1

1 In the **Model Builder** window, under **Component 1 (comp1)>Solid Mechanics (solid)** click **Piezoelectric Material 1**.

2 In the **Settings** window for **Piezoelectric Material**, locate the **Domain Selection** section.

- 3 From the **Selection** list, choose **+Z poled Piezo**.

Mechanical Damping 1

In the **Physics** toolbar, click  **Attributes** and choose **Mechanical Damping**.

Piezoelectric Material 2

- 1 Right-click **Piezoelectric Material 1** and choose **Duplicate**.
- 2 In the **Settings** window for **Piezoelectric Material**, locate the **Domain Selection** section.
- 3 From the **Selection** list, choose **-Z poled Piezo**.

Define a rotated system that will be used for the poling of the -Z poled piezoelectric disks.

DEFINITIONS

Rotated System 2 (sys2)

- 1 In the **Definitions** toolbar, click  **Coordinate Systems** and choose **Rotated System**.
- 2 In the **Settings** window for **Rotated System**, locate the **Rotation** section.
- 3 Find the **Euler angles (Z-X-Z)** subsection. In the β text field, type π .

SOLID MECHANICS (SOLID)

Piezoelectric Material 2

- 1 In the **Model Builder** window, under **Component 1 (comp1)>Solid Mechanics (solid)** click **Piezoelectric Material 2**.
- 2 In the **Settings** window for **Piezoelectric Material**, locate the **Coordinate System Selection** section.
- 3 From the **Coordinate system** list, choose **Rotated System 2 (sys2)**.

Spring Foundation 1

- 1 In the **Physics** toolbar, click  **Boundaries** and choose **Spring Foundation**.
- 2 In the **Settings** window for **Spring Foundation**, locate the **Boundary Selection** section.
- 3 From the **Selection** list, choose **Spring foundation boundaries**.
- 4 Locate the **Spring** section. From the **Spring type** list, choose **Total spring constant**.
- 5 In the k_{tot} text field, type 10000[N/m].

Bolt Pretension 1

- 1 In the **Physics** toolbar, click  **Global** and choose **Bolt Pretension**.
- 2 In the **Settings** window for **Bolt Pretension**, locate the **Bolt Pretension** section.

3 In the F_p text field, type F_pre.

Bolt Selection I

- 1 In the **Model Builder** window, expand the **Bolt Pretension I** node, then click **Bolt Selection I**.
- 2 In the **Settings** window for **Bolt Selection**, locate the **Boundary Selection** section.
- 3 From the **Selection** list, choose **Pretension cut (Simple Bolt, No Thread I)**.

Continuity I

- 1 In the **Physics** toolbar, click  **Pairs** and choose **Continuity**.
- 2 In the **Settings** window for **Continuity**, locate the **Pair Selection** section.
- 3 Under **Pairs**, click **+ Add**.
- 4 In the **Add** dialog box, select **Identity Boundary Pair I (apI)** in the **Pairs** list.
- 5 Click **OK**.

Linear Elastic Material I

In the **Model Builder** window, click **Linear Elastic Material I**.

Damping I

- 1 In the **Physics** toolbar, click  **Attributes** and choose **Damping**.
- 2 In the **Settings** window for **Damping**, locate the **Damping Settings** section.
- 3 From the **Input parameters** list, choose **Damping ratios**.
- 4 In the f_1 text field, type f0min.
- 5 In the ζ_1 text field, type eta_struct.
- 6 In the f_2 text field, type f0max.
- 7 In the ζ_2 text field, type eta_struct.

ELECTROSTATICS (ES)

- 1 In the **Model Builder** window, under **Component I (compI)** click **Electrostatics (es)**.
- 2 In the **Settings** window for **Electrostatics**, locate the **Domain Selection** section.
- 3 From the **Selection** list, choose **Piezo Domains**.

Ground I

- 1 In the **Physics** toolbar, click  **Boundaries** and choose **Ground**.
- 2 In the **Settings** window for **Ground**, locate the **Boundary Selection** section.
- 3 From the **Selection** list, choose **Ground boundaries**.

Terminal 1

- 1 In the **Physics** toolbar, click  **Boundaries** and choose **Terminal**.
- 2 In the **Settings** window for **Terminal**, locate the **Boundary Selection** section.
- 3 From the **Selection** list, choose **Voltage boundaries**.
- 4 Locate the **Terminal** section. From the **Terminal type** list, choose **Voltage**.
- 5 In the V_0 text field, type `linper(V0)`.

The `linper()` operator ensures that the voltage V_0 is only applied in the frequency domain perturbation study step and not during the stationary analysis. If you have the AC/DC Module you can right click and add the Harmonic Perturbation sub-feature, which will do the same.

Add the multiphysics feature between the acoustic and the structural domains.

MULTIPHYSICS

Acoustic-Structure Boundary 1 (asb1)

- 1 In the **Physics** toolbar, click  **Multiphysics Couplings** and choose **Boundary>Acoustic-Structure Boundary**.
- 2 In the **Settings** window for **Acoustic-Structure Boundary**, locate the **Boundary Selection** section.
- 3 From the **Selection** list, choose **Submerged boundaries**.

Modify the piezoelectric material to account for the variation of properties-

MATERIALS

Lead Zirconate Titanate (PZT-4) (with constitutive model)

- 1 In the **Model Builder** window, under **Component 1 (comp1)>Materials** click **Lead Zirconate Titanate (PZT-4) (mat4)**.
- 2 In the **Settings** window for **Material**, type Lead Zirconate Titanate (PZT-4) (with constitutive model) in the **Label** text field.

3 Locate the **Material Contents** section. In the table, enter the following settings:

Property	Variable	Value	Unit	Property group
Elasticity matrix, Voigt notation	{cE11, cE12, cE22, cE13, cE23, cE33, cE14, cE24, cE34, cE44, cE15, cE25, cE35, cE45, cE55, cE16, cE26, cE36, cE46, cE56, cE66} ; cEij = cEji	{1.38999e+011[Pa], 7.78366e+010[Pa], 1.38999e+011[Pa], 7.42836e+010[Pa], 7.42836e+010[Pa], 1.15412e+011[Pa]*c33_factor(pzt_stress), 0[Pa],0[Pa], 0[Pa],2.5641e+010[Pa],0[Pa], 0[Pa],0[Pa], 0[Pa],2.5641e+010[Pa],0[Pa], 0[Pa],0[Pa], 0[Pa],0[Pa], 3.0581e+010[Pa]}	Pa	Stress-charge form

Property	Variable	Value	Unit	Property group
Coupling matrix, Voigt notation	{eES11, eES21, eES31, eES12, eES22, eES32, eES13, eES23, eES33, eES14, eES24, eES34, eES15, eES25, eES35, eES16, eES26, eES36}	{0[C/m ²], 0[C/m ²], -5.20279[C/m ²], 0[C/m ²], 0[C/m ²], -5.20279[C/m ²], 0[C/m ²], 0[C/m ²], 15.0804[C/m ²]* d33_factor(pzt_stress), 0[C/m ²], 12.7179[C/m ²], 0[C/m ²], 12.7179[C/m ²], 0[C/m ²], 0[C/m ²], 0[C/m ²], 0[C/m ²], 0[C/m ²]}	C/m ²	Stress-charge form
Loss factor for elasticity matrix cE	eta_cE_iso ; eta_cEii = eta_cE_iso, eta_cEij = 0	0.01* loss_factor(pzt_stress)	l	Stress-charge form

Mesh the geometry; create a tetrahedral mesh in the solid and the water-inner domains and create a swept mesh in the PML.

MESH 1

Mapped 1

1 In the **Mesh** toolbar, click  **Boundary** and choose **Mapped**.

2 Select Boundaries 3, 8, 22, 23, 70, 77, 97, and 109 only.

Size

1 In the **Model Builder** window, click **Size**.

2 In the **Settings** window for **Size**, locate the **Element Size** section.

3 Click the **Custom** button.

4 Locate the **Element Size Parameters** section. In the **Maximum element size** text field, type 6[mm].

5 In the **Minimum element size** text field, type 1[mm].

6 In the **Curvature factor** text field, type 0.3.

7 Click  **Build All**.

Swept I

- 1 In the **Mesh** toolbar, click  **Swept**.
- 2 In the **Settings** window for **Swept**, locate the **Domain Selection** section.
- 3 From the **Geometric entity level** list, choose **Domain**.
- 4 Select Domains 1 and 4–7 only.

Distribution I

- 1 Right-click **Swept I** and choose **Distribution**.
- 2 In the **Settings** window for **Distribution**, locate the **Domain Selection** section.
- 3 From the **Selection** list, choose **Piezo Domains**.
- 4 Locate the **Distribution** section. In the **Number of elements** text field, type 2.

Free Tetrahedral I

In the **Mesh** toolbar, click  **Free Tetrahedral**.

Size I

- 1 Right-click **Free Tetrahedral I** and choose **Size**.
Apply a mesh setting on the Destination boundaries of the Identity Pair such that the mesh on these surfaces is somewhat finer than the mesh on the Source boundaries of the Identity Pair.
- 2 In the **Settings** window for **Size**, locate the **Geometric Entity Selection** section.
- 3 From the **Geometric entity level** list, choose **Boundary**.
- 4 From the **Selection** list, choose **Ground boundaries**.
- 5 Click  **Build All**.

STUDY I

Frequency Domain Perturbation

- 1 In the **Study** toolbar, click  **Study Steps** and choose **Frequency Domain> Frequency Domain Perturbation**.

The Bolt Pretension step solves for the effect of pretension in the bolt. This is a stationary step and does not solve the Acoustics problem - this can be seen from the small orange exclamation marks next to the acoustics in the **Physics and Variables Selection** section. The Frequency-Domain Perturbation step solves all the physics including the induced effect of the pretension of the bolt.

- 2 In the **Settings** window for **Frequency Domain Perturbation**, locate the **Study Settings** section.
- 3 From the **Frequency unit** list, choose **kHz**.
- 4 In the **Frequencies** text field, type `1 2 5 10 20 range(f0min, f0step, f0max)`.
Make sure to select the **Include geometric nonlinearity** check box - if it is not selected the effect of the pretensioning will not be included as the linearization point for the frequency domain study.
- 5 Select the **Include geometric nonlinearity** check box.

Step 1: Bolt Pretension

- 1 In the **Model Builder** window, click **Step 1: Bolt Pretension**.
- 2 In the **Settings** window for **Bolt Pretension**, locate the **Physics and Variables Selection** section.
- 3 In the table, clear the **Solve for** check box for **Pressure Acoustics, Boundary Elements (pabe)**.
- 4 In the table, clear the **Solve for** check box for **Acoustic-Structure Boundary 1 (asb1)**.

Parametric Sweep

- 1 In the **Study** toolbar, click  **Parametric Sweep**.
- 2 In the **Settings** window for **Parametric Sweep**, locate the **Study Settings** section.
- 3 Click **+ Add**.
- 4 In the table, enter the following settings:

Parameter name	Parameter value list	Parameter unit
F_pre (Bolt prestress force)	1 .9 4 .4	kN

- 5 In the **Model Builder** window, click **Study 1**.
- 6 In the **Settings** window for **Study**, locate the **Study Settings** section.
- 7 Clear the **Generate default plots** check box.

Solution 1 (sol1)

- 1 In the **Study** toolbar, click  **Show Default Solver**.
- 2 In the **Model Builder** window, expand the **Solution 1 (sol1)** node.
- 3 In the **Model Builder** window, expand the **Study 1>Solver Configurations> Solution 1 (sol1)>Stationary Solver 2** node.
- 4 Right-click **Suggested Direct Solver (pze1_asb1)** and choose **Enable**.

- 5 In the **Study** toolbar, click  **Compute**.

The following instructions describe how to create the plots shown in the **Results** section.

RESULTS

Grid 3D 1

- 1 In the **Model Builder** window, expand the **Results** node.
- 2 Right-click **Results>Datasets** and choose **More 3D Datasets>Grid 3D**.
- 3 In the **Settings** window for **Grid 3D**, locate the **Data** section.
- 4 From the **Dataset** list, choose **Study 1/Parametric Solutions 1 (sol3)**.
- 5 Locate the **Parameter Bounds** section. Find the **First parameter** subsection. In the **Minimum** text field, type -50[mm].
- 6 In the **Maximum** text field, type 0.
- 7 Find the **Second parameter** subsection. In the **Minimum** text field, type -50[mm].
- 8 In the **Maximum** text field, type 50[mm].
- 9 Find the **Third parameter** subsection. In the **Maximum** text field, type -150[mm].
- 10 Click to expand the **Resolution** section. In the **x resolution** text field, type 40.
- 11 In the **y resolution** text field, type 80.
- 12 In the **z resolution** text field, type 120.
- 13 Click  **Plot**.

Static Stress from Pretension

- 1 In the **Results** toolbar, click  **3D Plot Group**.
- 2 In the **Settings** window for **3D Plot Group**, type Static Stress from Pretension in the **Label** text field.
- 3 Locate the **Data** section. From the **Dataset** list, choose **Study 1/Parametric Solutions 1 (sol3)**.
- 4 Click to expand the **Title** section. From the **Title type** list, choose **Label**.
- 5 Locate the **Plot Settings** section. Clear the **Plot dataset edges** check box.
- 6 Locate the **Color Legend** section. Select the **Show units** check box.

Volume 1

- 1 Right-click **Static Stress from Pretension** and choose **Volume**.
- 2 In the **Settings** window for **Volume**, locate the **Expression** section.
- 3 In the **Expression** text field, type `solid.sz`.

- 4 From the **Unit** list, choose **MPa**.
- 5 From the **Expression evaluated for** list, choose **Static solution**.
- 6 Click to expand the **Range** section. Select the **Manual color range** check box.
- 7 In the **Minimum** text field, type -100.
- 8 In the **Maximum** text field, type 400.

Filter 1

- 1 Right-click **Volume 1** and choose **Filter**.
- 2 In the **Settings** window for **Filter**, locate the **Element Selection** section.
- 3 In the **Logical expression for inclusion** text field, type $x > -0.01$ [mm].

Deformation 1

- 1 In the **Model Builder** window, right-click **Volume 1** and choose **Deformation**.
- 2 In the **Settings** window for **Deformation**, locate the **Expression** section.
- 3 From the **Expression evaluated for** list, choose **Static solution**.
- 4 Locate the **Scale** section. Select the **Scale factor** check box.
- 5 In the associated text field, type 120.

Line 1

- 1 In the **Model Builder** window, right-click **Static Stress from Pretension** and choose **Line**.
- 2 In the **Settings** window for **Line**, locate the **Expression** section.
- 3 In the **Expression** text field, type 0.
- 4 From the **Expression evaluated for** list, choose **Static solution**.
- 5 Click to expand the **Title** section. From the **Title type** list, choose **None**.
- 6 Locate the **Coloring and Style** section. From the **Coloring** list, choose **Uniform**.
- 7 From the **Color** list, choose **Black**.
- 8 Click to expand the **Inherit Style** section. From the **Plot** list, choose **Volume 1**.
- 9 Clear the **Color** check box.
- 10 Clear the **Color and data range** check box.

Deformation 1

In the **Model Builder** window, right-click **Deformation 1** and choose **Copy**.

Deformation 1

In the **Model Builder** window, right-click **Line 1** and choose **Paste Deformation**.

Filter 1

In the **Model Builder** window, right-click **Filter 1** and choose **Copy**.

Filter 1

1 In the **Model Builder** window, right-click **Line 1** and choose **Paste Filter**.

Now loop through the prestress force to reproduce the results on [Figure 3](#).

Static Deformation from Pretension

1 In the **Model Builder** window, right-click **Filter 1** and choose **Duplicate**.

2 In the **Model Builder** window, click **Static Stress from Pretension 1**.

3 In the **Settings** window for **3D Plot Group**, type Static Deformation from Pretension in the **Label** text field.

Volume 1

1 In the **Model Builder** window, click **Volume 1**.

2 In the **Settings** window for **Volume**, locate the **Expression** section.

3 In the **Expression** text field, type w .

4 Locate the **Range** section. In the **Minimum** text field, type -0.015 .

5 In the **Maximum** text field, type 0.025 .

6 In the **Static Deformation from Pretension** toolbar, click  **Plot**.

Now loop through the prestress force to reproduce the results on [Figure 4](#).

Acoustic Pressure

1 In the **Home** toolbar, click  **Add Plot Group** and choose **3D Plot Group**.

2 In the **Settings** window for **3D Plot Group**, type Acoustic Pressure in the **Label** text field.

3 Locate the **Data** section. From the **Dataset** list, choose **Grid 3D 1**.

4 From the **Parameter value (freq (kHz))** list, choose **43**.

5 Locate the **Plot Settings** section. Clear the **Plot dataset edges** check box.

Multislice 1



1 In the **Acoustic Pressure** toolbar, click  **More Plots** and choose **Multislice**.

2 In the **Settings** window for **Multislice**, locate the **Multiplane Data** section.

3 Find the **x-planes** subsection. From the **Entry method** list, choose **Coordinates**.

4 In the **Coordinates** text field, type 0 .

5 Locate the **Coloring and Style** section. From the **Color table** list, choose **Wave**.

- 6 Select the **Symmetrize color range** check box.
- 7 In the **Acoustic Pressure** toolbar, click  **Plot**.
- 8 Click the  **Zoom Extents** button in the **Graphics** toolbar.

Line 1

- 1 In the **Model Builder** window, right-click **Acoustic Pressure** and choose **Line**.
- 2 In the **Settings** window for **Line**, locate the **Data** section.
- 3 From the **Dataset** list, choose **Study 1/Parametric Solutions 1 (sol3)**.
- 4 From the **Solution parameters** list, choose **From parent**.
- 5 Locate the **Expression** section. In the **Expression** text field, type 0.
- 6 Locate the **Title** section. From the **Title type** list, choose **None**.
- 7 Locate the **Coloring and Style** section. From the **Coloring** list, choose **Uniform**.
- 8 From the **Color** list, choose **Black**.
- 9 In the **Acoustic Pressure** toolbar, click  **Plot**.

Surface 1

- 1 Right-click **Acoustic Pressure** and choose **Surface**.
- 2 In the **Settings** window for **Surface**, locate the **Data** section.
- 3 From the **Dataset** list, choose **Study 1/Parametric Solutions 1 (sol3)**.
- 4 From the **Solution parameters** list, choose **From parent**.
- 5 Locate the **Expression** section. In the **Expression** text field, type `pabe.p_t_bnd`.
- 6 Click to expand the **Inherit Style** section. From the **Plot** list, choose **Multislice 1**.
- 7 In the **Acoustic Pressure** toolbar, click  **Plot**.

The plot should look like [Figure 5](#).

Sound Pressure Level

- 1 Right-click **Acoustic Pressure** and choose **Duplicate**.
- 2 In the **Settings** window for **3D Plot Group**, type **Sound Pressure Level1** in the **Label** text field.

Multislice 1

- 1 In the **Model Builder** window, expand the **Results>Sound Pressure Level** node, then click **Multislice 1**.
- 2 In the **Settings** window for **Multislice**, locate the **Expression** section.
- 3 In the **Expression** text field, type `pabe.Lp`.

- 4 Locate the **Coloring and Style** section. From the **Color table** list, choose **Rainbow**.
- 5 Clear the **Symmetrize color range** check box.
- 6 In the **Sound Pressure Level** toolbar, click  **Plot**.

Surface 1

- 1 In the **Model Builder** window, click **Surface 1**.
- 2 In the **Settings** window for **Surface**, locate the **Expression** section.
- 3 In the **Expression** text field, type `pabe.Lp_bnd`.
- 4 In the **Sound Pressure Level** toolbar, click  **Plot**.

The plot should look like [Figure 6](#).

Voltage

- 1 In the **Home** toolbar, click  **Add Plot Group** and choose **3D Plot Group**.
- 2 In the **Settings** window for **3D Plot Group**, type `Voltage` in the **Label** text field.
- 3 Locate the **Data** section. From the **Dataset** list, choose **Study 1/ Parametric Solutions 1 (sol3)**.
- 4 Click to expand the **Selection** section. From the **Geometric entity level** list, choose **Domain**.
- 5 From the **Selection** list, choose **Piezo Domains**.

Volume 1

- 1 Right-click **Voltage** and choose **Volume**.
- 2 In the **Settings** window for **Volume**, locate the **Expression** section.
- 3 In the **Expression** text field, type `V`.

Filter 1

- 1 Right-click **Volume 1** and choose **Filter**.
- 2 In the **Settings** window for **Filter**, locate the **Element Selection** section.
- 3 In the **Logical expression for inclusion** text field, type `x > -0.01 [mm]`.
- 4 In the **Voltage** toolbar, click  **Plot**.

The plot should look like [Figure 8](#).

Dynamic Deformation

- 1 In the **Model Builder** window, right-click **Static Deformation from Pretension** and choose **Duplicate**.
- 2 In the **Model Builder** window, click **Static Deformation from Pretension 1**.

- 3 In the **Settings** window for **3D Plot Group**, type Dynamic Deformation in the **Label** text field.

Volume 1

- 1 In the **Model Builder** window, click **Volume 1**.
- 2 In the **Settings** window for **Volume**, locate the **Expression** section.
- 3 From the **Expression evaluated for** list, choose **Harmonic perturbation**.
- 4 Locate the **Range** section. Clear the **Manual color range** check box.

Deformation 1

- 1 In the **Model Builder** window, expand the **Volume 1** node, then click **Deformation 1**.
- 2 In the **Settings** window for **Deformation**, locate the **Expression** section.
- 3 From the **Expression evaluated for** list, choose **Harmonic perturbation**.
- 4 Locate the **Scale** section. Clear the **Scale factor** check box.

Deformation 1

- 1 In the **Model Builder** window, expand the **Results>Dynamic Deformation>Line 1** node, then click **Deformation 1**.
- 2 In the **Settings** window for **Deformation**, locate the **Expression** section.
- 3 From the **Expression evaluated for** list, choose **Harmonic perturbation**.
Loop through the frequencies to reproduce the results on [Figure 7](#).

Specific Acoustic Impedance

- 1 In the **Home** toolbar, click  **Add Plot Group** and choose **ID Plot Group**.
- 2 In the **Settings** window for **ID Plot Group**, type Specific Acoustic Impedance in the **Label** text field.
- 3 Locate the **Data** section. From the **Dataset** list, choose **Study 1/ Parametric Solutions 1 (sol3)**.
- 4 From the **Parameter selection (F_pre)** list, choose **From list**.
- 5 In the **Parameter values (F_pre (kN))** list, select **4.4**.
- 6 Click to expand the **Title** section. From the **Title type** list, choose **Label**.
- 7 Locate the **Plot Settings** section. Select the **x-axis label** check box.
- 8 In the associated text field, type f (kHz).
- 9 Select the **y-axis label** check box.
- 10 In the associated text field, type $Z/(\rho c)$.
- 11 Locate the **Legend** section. From the **Position** list, choose **Upper left**.

Global 1

- 1 Right-click **Specific Acoustic Impedance** and choose **Global**.
- 2 In the **Settings** window for **Global**, locate the **y-Axis Data** section.
- 3 In the table, enter the following settings:

Expression	Unit	Description
abs(Zaco)	1	
real(Zaco)	1	
imag(Zaco)	1	

- 4 Click to expand the **Legends** section. From the **Legends** list, choose **Manual**.
- 5 In the table, enter the following settings:

Legends
Absolute value
Real part
Imaginary part

- 6 Locate the **x-Axis Data** section. From the **Parameter** list, choose **Expression**.
- 7 In the **Expression** text field, type **freq**.
- 8 From the **Unit** list, choose **kHz**.
- 9 Click to expand the **Coloring and Style** section. In the **Width** text field, type **2**.
- 10 Find the **Line style** subsection. From the **Line** list, choose **Cycle**.
- 11 In the **Specific Acoustic Impedance** toolbar, click  **Plot**.

The plot should look like [Figure 9](#).

Transmitting Voltage Response (TVR)

- 1 In the **Model Builder** window, right-click **Specific Acoustic Impedance** and choose **Duplicate**.
- 2 In the **Settings** window for **ID Plot Group**, type **Transmitting Voltage Response (TVR)** in the **Label** text field.
- 3 Locate the **Data** section. From the **Parameter selection (F_pre)** list, choose **All**.
- 4 Locate the **Plot Settings** section. In the **y-axis label** text field, type **TVR (dB re1. 1\mu Pa/V)**.
- 5 Locate the **Legend** section. From the **Position** list, choose **Lower right**.

Global I

- 1 In the **Model Builder** window, expand the **Transmitting Voltage Response (TVR)** node, then click **Global I**.
- 2 In the **Settings** window for **Global**, click **Replace Expression** in the upper-right corner of the **y-Axis Data** section. From the menu, choose **Component 1 (comp1)>Definitions>Variables>TVR - Transmitting Voltage Response (TVR)**.
- 3 Locate the **Legends** section. From the **Legends** list, choose **Automatic**.
- 4 In the **Transmitting Voltage Response (TVR)** toolbar, click  **Plot**.
The plot should look like [Figure 10](#).

Directivity Index (DI)

- 1 In the **Model Builder** window, right-click **Specific Acoustic Impedance** and choose **Duplicate**.
- 2 In the **Settings** window for **ID Plot Group**, type **Directivity Index (DI)** in the **Label** text field.
- 3 Locate the **Plot Settings** section. In the **y-axis label** text field, type **DI (dB)**.

Global I

- 1 In the **Model Builder** window, expand the **Directivity Index (DI)** node, then click **Global I**.
- 2 In the **Settings** window for **Global**, click **Replace Expression** in the upper-right corner of the **y-Axis Data** section. From the menu, choose **Component 1 (comp1)>Definitions>Variables>DI - Directivity index of tonpilz transducer**.
- 3 Click **Add Expression** in the upper-right corner of the **y-Axis Data** section. From the menu, choose **Component 1 (comp1)>Definitions>Variables>DI_fl_pist - Directivity index of flanged piston**.
- 4 Locate the **Legends** section. From the **Legends** list, choose **Automatic**.
- 5 In the **Directivity Index (DI)** toolbar, click  **Plot**.
The plot should look like [Figure 11](#).

Total Radiated Power

- 1 In the **Model Builder** window, right-click **Directivity Index (DI)** and choose **Duplicate**.
- 2 In the **Settings** window for **ID Plot Group**, type **Total Radiated Power** in the **Label** text field.
- 3 Locate the **Data** section. From the **Parameter selection (F_pre)** list, choose **All**.
- 4 Locate the **Plot Settings** section. In the **y-axis label** text field, type **Ptot (mW)**.
- 5 Locate the **Legend** section. From the **Position** list, choose **Upper right**.

Global 1

- 1 In the **Model Builder** window, expand the **Total Radiated Power** node, then click **Global 1**.
- 2 In the **Settings** window for **Global**, click **Replace Expression** in the upper-right corner of the **y-Axis Data** section. From the menu, choose **Component 1 (comp1)>Definitions>Variables>Ptot - Total radiated power - W**.
- 3 Locate the **y-Axis Data** section. In the table, enter the following settings:

Expression	Unit	Description
Ptot	mW	Total radiated power

- 4 In the **Total Radiated Power** toolbar, click  **Plot**.

The plot should look like [Figure 12](#).

Electric Impedance

- 1 In the **Home** toolbar, click  **Add Plot Group** and choose **ID Plot Group**.
- 2 In the **Settings** window for **ID Plot Group**, type **Electric Impedance** in the **Label** text field.
- 3 Locate the **Data** section. From the **Dataset** list, choose **Study 1/ Parametric Solutions 1 (sol3)**.
- 4 Locate the **Title** section. From the **Title type** list, choose **Label**.
- 5 Locate the **Plot Settings** section. Select the **Two y-axes** check box.
- 6 Locate the **Axis** section. Select the **y-axis log scale** check box.

Global 1

- 1 Right-click **Electric Impedance** and choose **Global**.
- 2 In the **Settings** window for **Global**, locate the **y-Axis Data** section.
- 3 In the table, enter the following settings:

Expression	Unit	Description
abs(1/es.Y11)	Ω	Z _{e1}

- 4 Locate the **Coloring and Style** section. Set the **Width** value to **2**.

Global 2

- 1 Right-click **Global 1** and choose **Duplicate**.
- 2 In the **Settings** window for **Global**, locate the **y-Axis** section.
- 3 Select the **Plot on secondary y-axis** check box.

4 Locate the **y-Axis Data** section. In the table, enter the following settings:

Expression	Unit	Description
$\arg(1/\text{es.Y11})$	deg	Angle

5 Locate the **Coloring and Style** section. Find the **Line style** subsection. From the **Line** list, choose **Dotted**.

6 From the **Color** list, choose **Cycle (reset)**.

7 In the **Electric Impedance** toolbar, click  **Plot**.

The plot should look like [Figure 13](#).

Grid ID 2

1 In the **Results** toolbar, click  **More Datasets** and choose **Grid>Grid ID**.

2 In the **Settings** window for **Grid ID**, locate the **Parameter Bounds** section.

3 In the **Minimum** text field, type 30.

4 In the **Maximum** text field, type 90.

Variation of properties

1 In the **Results** toolbar, click  **ID Plot Group**.

2 In the **Settings** window for **ID Plot Group**, type Variation of properties in the **Label** text field.

3 Locate the **Title** section. From the **Title type** list, choose **Label**.

4 Locate the **Plot Settings** section. Select the **y-axis label** check box.

5 In the associated text field, type Factor (1).

6 Locate the **Legend** section. From the **Position** list, choose **Lower right**.

Line Graph 1

1 Right-click **Variation of properties** and choose **Line Graph**.

2 In the **Settings** window for **Line Graph**, locate the **Data** section.

3 From the **Dataset** list, choose **Grid ID 2**.

4 From the **Parameter selection (freq)** list, choose **Last**.

5 Locate the **y-Axis Data** section. In the **Expression** text field, type $\text{c33_factor}(x[1/\text{mm}][\text{MPa}])$.

6 Locate the **x-Axis Data** section. From the **Parameter** list, choose **Expression**.

7 In the **Expression** text field, type $x[1/\text{mm}][\text{MPa}]$.

8 Select the **Description** check box.

- 9 In the associated text field, type Pretension.
- 10 From the **Unit** list, choose **MPa**.
- 11 Click to expand the **Legends** section. Select the **Show legends** check box.
- 12 Find the **Include** subsection. Clear the **Solution** check box.
- 13 Select the **Description** check box.
- 14 Click to expand the **Coloring and Style** section. Set the **Width** value to **2**.
- 15 In the **Variation of properties** toolbar, click  **Plot**.

Line Graph 2

- 1 Right-click **Line Graph 1** and choose **Duplicate**.
- 2 In the **Settings** window for **Line Graph**, locate the **y-Axis Data** section.
- 3 In the **Expression** text field, type `loss_factor(x[1/mm][MPa])`.

Line Graph 3

- 1 Right-click **Line Graph 2** and choose **Duplicate**.
- 2 In the **Settings** window for **Line Graph**, locate the **y-Axis Data** section.
- 3 In the **Expression** text field, type `d33_factor(x[1/mm][MPa])`.
- 4 In the **Variation of properties** toolbar, click  **Plot**.

Annotation 1

- 1 In the **Model Builder** window, right-click **Variation of properties** and choose **Annotation**.
 - 2 In the **Settings** window for **Annotation**, locate the **Coloring and Style** section.
 - 3 Clear the **Show point** check box.
 - 4 Locate the **Position** section. In the **x** text field, type 30.
 - 5 In the **Variation of properties** toolbar, click  **Plot**.
- The plot should look like [Figure 2](#).

