



Acoustic-Structure Interaction

Introduction

This model provides a tutorial on modeling the interaction of sound with elastic, solid structures by using a specific example of an elastic cylinder in water. The sound will cause movement of the solid cylinder, which in turn will induce new sound waves in the air; thus, full bidirectional coupling between the acoustic medium (water) and the cylinder is required to realistically simulate this situation.

This model is similar to the interaction of acoustic signals (sound) with most everyday objects: Liquid or gas acoustics coupled to structural objects have application in many engineering fields, for example, loudspeakers, acoustic sensors, nondestructive testing, or medical ultrasound diagnostics of the human body.

The intent with this tutorial model is to illustrate the modeling process rather than to provide an exhaustive illustration of the acoustic-solid interaction capabilities of COMSOL.

Model Definition

This model simulates the behavior of a solid cylinder in an water domain with an incident acoustic wave in the water. The object's walls are impacted by the acoustic pressure. The model calculates the frequency response from the solid and then feeds this information back to the acoustics domain so that it can analyze the resulting wave pattern. As such, the model is a good example of a scattering acoustic-solid interaction problem.

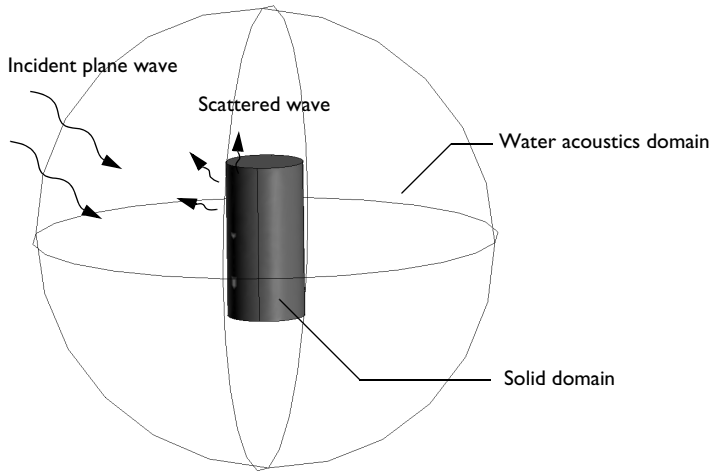

Figure 1: Geometric setup of an aluminum cylinder immersed in water.

To set up the model, use the Acoustic-Solid Interaction, Frequency Domain multiphysics interface. This interface involves two physics interfaces: Solid Mechanics and Pressure Acoustics, Frequency Domain. It also sets up the Acoustic-Structure Boundary multiphysics coupling.

[Figure 1](#) illustrates the aluminum cylinder immersed in water. The incident wave is 60 kHz, in the ultrasound region. The cylinder is 2 cm in height and has a diameter of 1 cm. The water acoustic domain is truncated as a sphere with a reasonably large diameter. What drives the system is an incident plane wave from the surroundings into the spherical boundary. The harmonic acoustic pressure in the water on the surface of the cylinder acts as a boundary load in the 3D solid to ensure continuity in pressure. The model calculates harmonic displacements and stresses in the solid cylinder, and it then uses the normal acceleration of the solid surface in the acoustics domain boundary to ensure continuity in acceleration.

DOMAIN EQUATIONS

The default **Pressure Acoustics** feature models harmonic sound waves in the water domain by means of the Helmholtz equation for sound pressure:

$$\nabla \cdot \left(-\frac{1}{\rho_c} \nabla p \right) - \frac{\omega^2 p}{\rho_c c_c^2} = 0$$

Where p is the pressure (SI unit: N/m^2), ρ_c is the density (kg/m^3), ω is the angular frequency (SI unit: rad/s), and c_c is the speed of sound (SI unit: m/s). Note that both the density and the speed of sound can be complex valued (hence the subscript “c”) in order model fluids with dissipating properties. In this model they are real valued as no damping is modeled.

TABLE 1: ACOUSTICS DOMAIN DATA.

| QUANTITY | VALUE | DESCRIPTION |
|-------------------|----------------------------|----------------|
| ρ_c | 997 kg/m^3 | Density |
| c_c | 1500 m/s | Speed of sound |
| $f = \omega/2\pi$ | 60 kHz | Frequency |

To calculate the harmonic stresses and strains in the solid cylinder for a frequency-response analysis, use the default **Linear Elastic Material** model feature under the Solid Mechanics interface. The material data comes from the built-in database for Aluminum 3003-H18.

BOUNDARY CONDITIONS

Outer Perimeter

On the outer spherical perimeter of the water domain (Figure 1) specify an incident plane wave to represent an incoming sound wave. A superimposed spherical wave is allowed to travel out of the system as a response from the cylinder. In the Pressure Acoustics, Frequency Domain interface you implement this scenario by using the prepared **Spherical Wave Radiation** boundary condition. Such boundary condition is useful when the surroundings are only a continuation of the domain.

TABLE 2: RADIATION BOUNDARY CONDITION SETTINGS.

| QUANTITY | VALUE | DESCRIPTION |
|----------|---|--------------------------------|
| k | $(\sin \theta \cos \varphi, \sin \theta \sin \varphi, \cos \theta)$ | Incident wave direction vector |
| p_0 | 1 Pa | Pressure amplitude |

The incident wave direction k is controlled by the two angles $0 < \theta < \pi$ and $0 < \varphi < 2\pi$. The incident field is defined in the **Incident Pressure Field** subfeature.

Interface Cylinder-Water

The coupling between the fluid domain (pressure waves) and the solid is automatically done via the **Acoustic-Structure Boundary** multiphysics coupling. The automatic boundary condition sets the boundary load \mathbf{F} (force/unit area) on the solid cylinder to

$$\mathbf{F} = -\mathbf{n}_s p$$

where \mathbf{n}_s is the outward-pointing unit normal vector seen from inside the solid domain. While on the fluid side the normal acceleration experienced by the fluid is set equal to the normal acceleration of the solid. Mathematically this means that

$$-\mathbf{n}_a \cdot \left(-\frac{1}{\rho_0} \nabla p + \mathbf{q} \right) = a_n$$

where \mathbf{n}_a is the outward-pointing unit normal vector seen from inside the acoustics domain, and the normal acceleration a_n is equal to $(\mathbf{n}_a \cdot \mathbf{u})\omega^2$, where \mathbf{u} is the calculated harmonic-displacement vector of the solid structure.

HARD-WALL COMPARISON

As a reference you can also study a simpler model where the solid interface is regarded as a hard wall. This implies that the cylinder will not be affected by sound, but its presence will nonetheless affect how the sound is distributed. In the model this is achieved by setting a fixed constraint on all the solid boundaries, that is, $\mathbf{u} = \mathbf{0}$. This reduces the above condition ($a_n = 0$) to the sound hard boundary condition

$$\mathbf{n}_a \cdot \left(-\frac{1}{\rho_0} \nabla p + \mathbf{q} \right) = 0$$

Results and Discussion

Figure 2 displays the sound pressure as a slice plot. It is clear from which direction the sound wave propagates into the domain. The values of the deformation are very small, but the acceleration is large enough to have an impact on the sound waves.

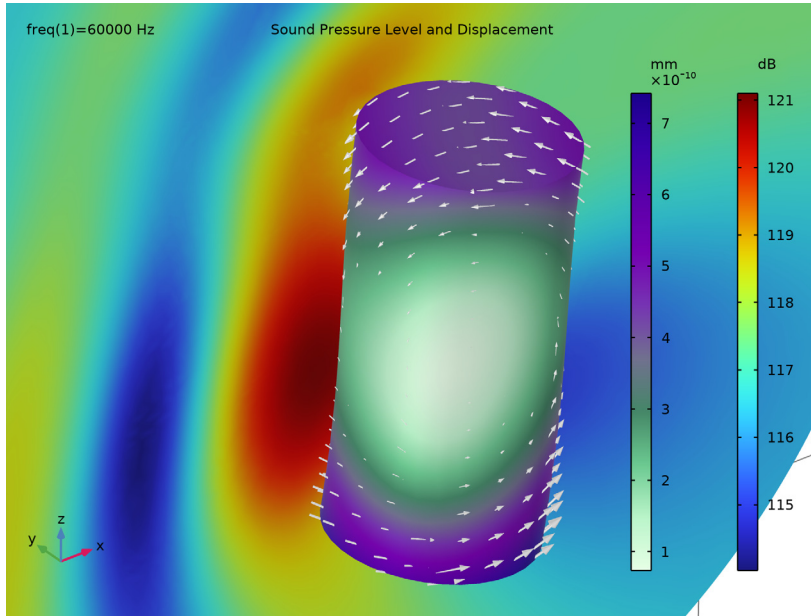

Figure 2: Displacement of the cylinder and the sound-pressure plot (dB) of the acoustic waves in the coupled problem. The arrow lengths are proportional to the surface acceleration, which is a direct measure of the sound-pressure interaction between the water and the cylinder.

Figure 3 shows a comparison between the hard-wall example and the full aluminum solid model. Near the cylinder wall the plot shows that the sound pressure level (SPL) is higher on the upstream side for the hard-wall case than for the aluminum model. This is also the case on the downstream side, where the SPL for the hard-wall model is higher than for the aluminum model. This shows that the hard wall reflects more than the aluminum case. The conclusion is that the mechanical properties of the metal object have an impact on the acoustic signature.

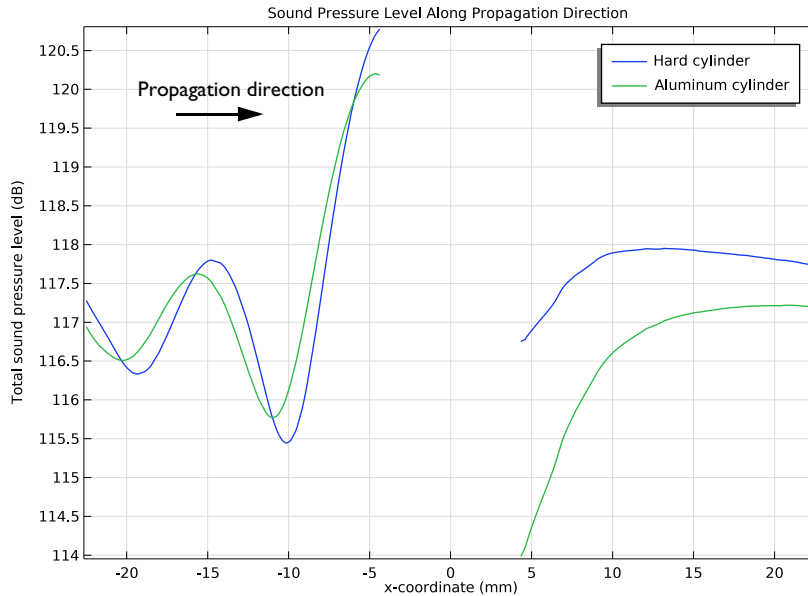



Figure 3: Sound pressure level on impact and on the shadow side of the cylinder.

Application Library path: Acoustics_Module/Tutorials,_Pressure_Acoustics/
acoustic_structure

Modeling Instructions

From the **File** menu, choose **New**.

NEW

In the **New** window, click  **Model Wizard**.

MODEL WIZARD

- 1 In the **Model Wizard** window, click  **3D**.
- 2 In the **Select Physics** tree, select **Acoustics>Acoustic-Structure Interaction>Acoustic-Solid Interaction, Frequency Domain**.
- 3 Click **Add**.

- 4 Click  **Study**.
- 5 In the **Select Study** tree, select **General Studies>Frequency Domain**.
- 6 Click  **Done**.

GLOBAL DEFINITIONS

Parameters 1

You may either add the parameters manually or load them from a text file.

- 1 In the **Model Builder** window, under **Global Definitions** click **Parameters 1**.
- 2 In the **Settings** window for **Parameters**, locate the **Parameters** section.
- 3 Click  **Load from File**.
- 4 Browse to the model's Application Libraries folder and double-click the file `acoustic_structure_parameters.txt`.

To add parameters manually, you can do as follows.

- 5 In the table, enter the following settings:

| Name | Expression | Value | Description |
|-------|---------------------------|-------------|---|
| f | 60 [kHz] | 60000 Hz | Frequency |
| phi | $(-\pi/6)$ [rad] | -0.5236 rad | Wave direction angle, phi |
| theta | $(4*\pi/6)$ [rad] | 2.0944 rad | Wave direction angle, theta |
| k1 | $\sin(\theta)*\cos(\phi)$ | 0.75 | Incident wave direction vector, X component |
| k2 | $\sin(\theta)*\sin(\phi)$ | -0.43301 | Incident wave direction vector, Y component |
| k3 | $\cos(\theta)$ | -0.5 | Incident wave direction vector, Z component |
| R | 30 [mm] | 0.03 m | Model domain radius |

GEOMETRY 1





- 1 In the **Model Builder** window, under **Component 1 (comp1)** click **Geometry 1**.
- 2 In the **Settings** window for **Geometry**, locate the **Units** section.
- 3 From the **Length unit** list, choose **mm**.

Cylinder 1 (cyl1)

- 1 In the **Geometry** toolbar, click  **Cylinder**.

- 2 In the **Settings** window for **Cylinder**, locate the **Size and Shape** section.
- 3 In the **Radius** text field, type 5.
- 4 In the **Height** text field, type 20.
- 5 Locate the **Position** section. In the **z** text field, type -10.
- 6 Click  **Build Selected**.

Sphere 1 (sph1)

- 1 In the **Geometry** toolbar, click  **Sphere**.
- 2 In the **Settings** window for **Sphere**, locate the **Size** section.
- 3 In the **Radius** text field, type R.
- 4 Click  **Build Selected**.
- 5 Click the  **Zoom Extents** button in the **Graphics** toolbar.
To see the interior:
- 6 Click the  **Wireframe Rendering** button in the **Graphics** toolbar.

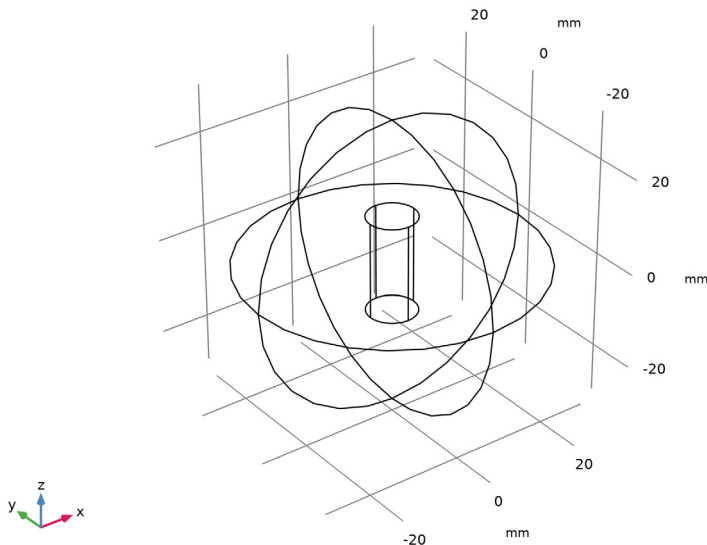

DEFINITIONS

Next, define a number of selections as sets of geometric entities to use when setting up the model.

Fluid Domain

- 1 In the **Definitions** toolbar, click  **Explicit**.
- 2 In the **Settings** window for **Explicit**, type Fluid Domain in the **Label** text field.
- 3 Select Domain 1 only.

Solid Domain

- 1 In the **Definitions** toolbar, click  **Explicit**.
- 2 In the **Settings** window for **Explicit**, type Solid Domain in the **Label** text field.
- 3 Select Domain 2 only.



Radiation Boundaries

- 1 In the **Definitions** toolbar, click  **Explicit**.
- 2 In the **Settings** window for **Explicit**, type Radiation Boundaries in the **Label** text field.
- 3 Locate the **Input Entities** section. Select the **All domains** check box.
- 4 Locate the **Output Entities** section. From the **Output entities** list, choose **Adjacent boundaries**.

Solid Boundaries

- 1 In the **Definitions** toolbar, click  **Explicit**.
- 2 In the **Settings** window for **Explicit**, type Solid Boundaries in the **Label** text field.
- 3 Select Domain 2 only.
- 4 Locate the **Output Entities** section. From the **Output entities** list, choose **Adjacent boundaries**.

ADD MATERIAL

- 1 In the **Home** toolbar, click  **Add Material** to open the **Add Material** window.
- 2 Go to the **Add Material** window.
- 3 In the tree, select **Built-in>Water, liquid**.
- 4 Click **Add to Component** in the window toolbar.
- 5 In the tree, select **Built-in>Aluminum 3003-H18**.
- 6 Click **Add to Component** in the window toolbar.
- 7 In the **Home** toolbar, click  **Add Material** to close the **Add Material** window.

MATERIALS

Water, liquid (mat1)

- 1 In the **Model Builder** window, under **Component 1 (comp1)>Materials** click **Water, liquid (mat1)**.
- 2 In the **Settings** window for **Material**, locate the **Geometric Entity Selection** section.
- 3 From the **Selection** list, choose **Fluid Domain**.

Aluminum 3003-H18 (mat2)

- 1 In the **Model Builder** window, click **Aluminum 3003-H18 (mat2)**.
- 2 In the **Settings** window for **Material**, locate the **Geometric Entity Selection** section.
- 3 From the **Selection** list, choose **Solid Domain**.

Now, set up the physics of the problem by defining the domain physics conditions and the boundary conditions.

PRESSURE ACOUSTICS, FREQUENCY DOMAIN (ACPR)

- 1 In the **Model Builder** window, under **Component 1 (comp1)** click **Pressure Acoustics, Frequency Domain (acpr)**.
- 2 In the **Settings** window for **Pressure Acoustics, Frequency Domain**, locate the **Domain Selection** section.
- 3 From the **Selection** list, choose **Fluid Domain**.
- 4 Locate the **Sound Pressure Level Settings** section. From the **Reference pressure for the sound pressure level** list, choose **Use reference pressure for water**.

Spherical Wave Radiation 1

- 1 In the **Physics** toolbar, click  **Boundaries** and choose **Spherical Wave Radiation**.
- 2 In the **Settings** window for **Spherical Wave Radiation**, locate the **Boundary Selection** section.
- 3 From the **Selection** list, choose **Radiation Boundaries**.

Incident Pressure Field 1

- 1 In the **Physics** toolbar, click  **Attributes** and choose **Incident Pressure Field**.
- 2 In the **Settings** window for **Incident Pressure Field**, locate the **Incident Pressure Field** section.
- 3 In the p_0 text field, type 1.
- 4 From the c list, choose **From material**.

5 From the **Material** list, choose **Water, liquid (mat1)**.

6 Specify the \mathbf{e}_k vector as

| | |
|----|---|
| k1 | x |
| k2 | y |
| k3 | z |

SOLID MECHANICS (SOLID)

1 In the **Model Builder** window, under **Component 1 (comp1)** click **Solid Mechanics (solid)**.

2 In the **Settings** window for **Solid Mechanics**, locate the **Domain Selection** section.

3 From the **Selection** list, choose **Solid Domain**.

MESH

Proceed and generate the mesh using the **Physics-controlled mesh** functionality. The frequency controlling the maximum element size is per default taken **From study**. Set the desired **Frequencies** in the study step. In general, 5 to 6 second-order elements per wavelength are needed to resolve the waves. For more details, see *Meshing (Resolving the Waves)* in the *Acoustics Module User's Guide*. In this model, we use 6 elements per wavelength; the default **Automatic** is to have 5.

STUDY 1 - SOUND HARD CYLINDER

1 In the **Model Builder** window, click **Study 1**.

2 In the **Settings** window for **Study**, type Study 1 - Sound Hard Cylinder in the **Label** text field.

3 Locate the **Study Settings** section. Clear the **Generate default plots** check box.

Step 1: Frequency Domain

1 In the **Model Builder** window, under **Study 1 - Sound Hard Cylinder** click **Step 1: Frequency Domain**.

2 In the **Settings** window for **Frequency Domain**, locate the **Study Settings** section.



3 In the **Frequencies** text field, type f.

MESH 1

1 In the **Model Builder** window, under **Component 1 (comp1)** click **Mesh 1**.

2 In the **Settings** window for **Mesh**, locate the **Pressure Acoustics, Frequency Domain (acpr)** section.

3 From the **Number of mesh elements per wavelength** list, choose **User defined**.

- 4 In the text field, type 6.
- 5 Click  **Build All**.
- 6 Click the  **Zoom Extents** button in the **Graphics** toolbar.
- 7 Click the  **Transparency** button in the **Graphics** toolbar.

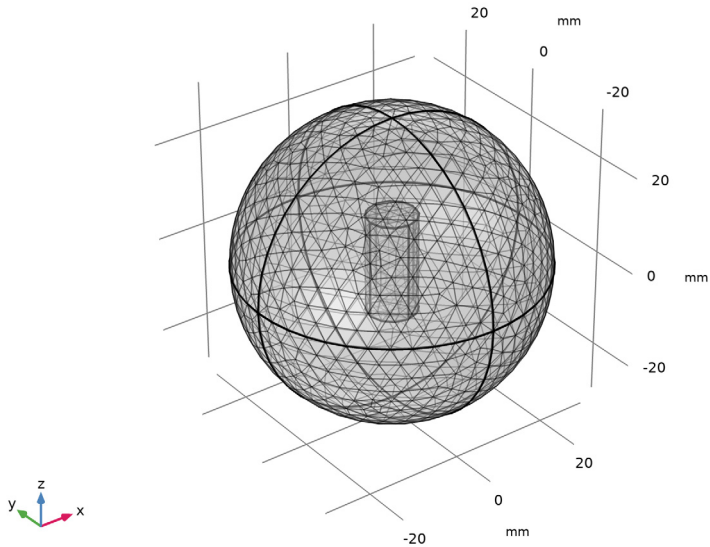

- 8 Click the  **Transparency** button in the **Graphics** toolbar to return to the default state.

STUDY I - SOUND HARD CYLINDER



Step 1: Frequency Domain

Disable the Solid Mechanics interface, which corresponds to the hard cylinder case.

- 1 In the **Model Builder** window, under **Study I - Sound Hard Cylinder** click **Step 1: Frequency Domain**.
- 2 In the **Settings** window for **Frequency Domain**, locate the **Physics and Variables Selection** section.
- 3 In the table, clear the **Solve for** check box for **Solid Mechanics (solid)**.
- 4 In the table, clear the **Solve for** check box for **Acoustic-Structure Boundary I (asb1)**.
- 5 In the **Home** toolbar, click  **Compute**.

Before visualizing this solution, include the structural analysis of the cylinder and compute the corresponding solution. You can do this by adding one more study.

ADD STUDY

- 1 In the **Home** toolbar, click  **Add Study** to open the **Add Study** window.
- 2 Go to the **Add Study** window.
- 3 Find the **Studies** subsection. In the **Select Study** tree, select **General Studies > Frequency Domain**.
- 4 Click **Add Study** in the window toolbar.
- 5 In the **Home** toolbar, click  **Add Study** to close the **Add Study** window.

STUDY 2 - ALUMINUM CYLINDER

- 1 In the **Model Builder** window, click **Study 2**.
- 2 In the **Settings** window for **Study**, type Study 2 - Aluminum Cylinder in the **Label** text field.
- 3 Locate the **Study Settings** section. Clear the **Generate default plots** check box.

Step 1: Frequency Domain

- 1 In the **Model Builder** window, under **Study 2 - Aluminum Cylinder** click **Step 1: Frequency Domain**.
- 2 In the **Settings** window for **Frequency Domain**, locate the **Study Settings** section.
- 3 In the **Frequencies** text field, type f .
- 4 In the **Home** toolbar, click  **Compute**.

RESULTS

To reproduce the plot in [Figure 3](#), which compares the sound pressure levels along a diameter in the propagation direction for the two cases, begin by defining datasets as follows.

Cut Line 3D 1

- 1 In the **Results** toolbar, click  **Cut Line 3D**.
- 2 In the **Settings** window for **Cut Line 3D**, locate the **Line Data** section.
- 3 In row **Point 1**, set **X** to $-R*k1$, **Y** to $-R*k2$, and **Z** to $-R*k3$.
- 4 In row **Point 2**, set **X** to $R*k1$, **Y** to $R*k2$, and **Z** to $R*k3$.

5 Click  **Plot**.

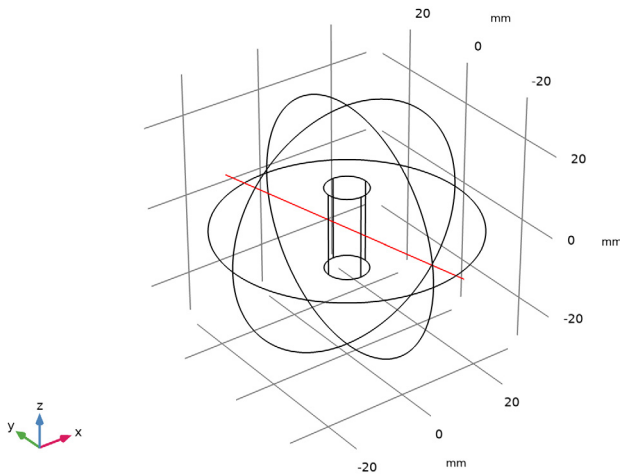

Cut Line 3D 2

- 1 Right-click **Cut Line 3D 1** and choose **Duplicate**.
- 2 In the **Settings** window for **Cut Line 3D**, locate the **Data** section.
- 3 From the **Dataset** list, choose **Study 2 - Aluminum Cylinder/Solution 2 (sol2)**.

Sound Pressure Level Along Propagation Direction

- 1 In the **Results** toolbar, click  **ID Plot Group**.
- 2 In the **Settings** window for **ID Plot Group**, type Sound Pressure Level Along Propagation Direction in the **Label** text field.
- 3 Click to expand the **Title** section. From the **Title type** list, choose **Label**.

Line Graph 1

- 1 Right-click **Sound Pressure Level Along Propagation Direction** and choose **Line Graph**.
- 2 In the **Settings** window for **Line Graph**, locate the **Data** section.
- 3 From the **Dataset** list, choose **Cut Line 3D 1**.
- 4 Click **Replace Expression** in the upper-right corner of the **y-Axis Data** section. From the menu, choose **Component 1 (comp1)>Pressure Acoustics, Frequency Domain>Pressure and sound pressure level>acpr.Lp_t - Total sound pressure level - dB**.
- 5 Click to expand the **Legends** section. Locate the **x-Axis Data** section. From the **Parameter** list, choose **Expression**.

- 6 In the **Expression** text field, type x .
- 7 Locate the **Legends** section. Select the **Show legends** check box.
- 8 From the **Legends** list, choose **Manual**.
- 9 In the table, enter the following settings:

| Legends |
|---------------|
| Hard cylinder |

Line Graph 2

- 1 Right-click **Line Graph 1** and choose **Duplicate**.
- 2 In the **Settings** window for **Line Graph**, locate the **Data** section.
- 3 From the **Dataset** list, choose **Cut Line 3D 2**.
- 4 Locate the **Legends** section. In the table, enter the following settings:

| Legends |
|-------------------|
| Aluminum cylinder |

- 5 In the **Sound Pressure Level Along Propagation Direction** toolbar, click  **Plot**.

Finally, follow the instructions below to create the plot shown in [Figure 2](#):

Sound Pressure Level and Displacement

- 1 In the **Home** toolbar, click  **Add Plot Group** and choose **3D Plot Group**.
- 2 In the **Settings** window for **3D Plot Group**, type Sound Pressure Level and Displacement in the **Label** text field.
- 3 Locate the **Data** section. From the **Dataset** list, choose **Study 2 - Aluminum Cylinder/ Solution 2 (sol2)**.
- 4 Locate the **Plot Settings** section. Clear the **Plot dataset edges** check box.
- 5 Locate the **Color Legend** section. Select the **Show units** check box.
- 6 Click to expand the **Title** section. From the **Title type** list, choose **Label**.

Surface 1

- 1 Right-click **Sound Pressure Level and Displacement** and choose **Surface**.
- 2 In the **Settings** window for **Surface**, click **Replace Expression** in the upper-right corner of the **Expression** section. From the menu, choose **Component 1 (comp1)>Solid Mechanics> Displacement>solid.disp - Displacement magnitude - m**.
- 3 Locate the **Coloring and Style** section. From the **Color table** list, choose **AuroraBorealis**.

Deformation 1

Right-click **Surface 1** and choose **Deformation**.

Slice 1

- 1 In the **Model Builder** window, right-click **Sound Pressure Level and Displacement** and choose **Slice**.
- 2 In the **Settings** window for **Slice**, click **Replace Expression** in the upper-right corner of the **Expression** section. From the menu, choose **Component 1 (comp1)>Pressure Acoustics, Frequency Domain>Pressure and sound pressure level>acpr.Lp_t - Total sound pressure level - dB**.
- 3 Locate the **Plane Data** section. From the **Plane** list, choose **ZX-planes**.
- 4 From the **Entry method** list, choose **Coordinates**.
- 5 In the **Y-coordinates** text field, type 5.

Arrow Surface 1

- 1 Right-click **Sound Pressure Level and Displacement** and choose **Arrow Surface**.
- 2 In the **Settings** window for **Arrow Surface**, click **Replace Expression** in the upper-right corner of the **Expression** section. From the menu, choose **Component 1 (comp1)>Solid Mechanics>Acceleration and velocity>solid.u_ttX,...,solid.u_ttZ - Acceleration**.
- 3 Locate the **Coloring and Style** section. From the **Arrow base** list, choose **Head**.
- 4 Select the **Scale factor** check box.
- 5 In the associated text field, type 20.
- 6 Locate the **Arrow Positioning** section. In the **Number of arrows** text field, type 5000.
- 7 Locate the **Coloring and Style** section. From the **Color** list, choose **White**.

Sound Pressure Level and Displacement

- 1 In the **Model Builder** window, click **Sound Pressure Level and Displacement**.
- 2 In the **Sound Pressure Level and Displacement** toolbar, click  **Plot**.
- 3 Click the **Zoom Box** button in the **Graphics** toolbar and then use the mouse to zoom in.

