



# Planar PCB Coil

## Introduction

---

Planar coils on printed-circuit board (PCB) are widely used for instance in radio-frequency identification, wireless charging and micro-motor devices. This tutorial model shows how to use the **Electric Currents in Shells** physics interface together with the **Magnetic Field** physics interface to compute the resistance and inductance of a planar PCB coil. The **Electric Currents in Shells** interface offers the advantage of drawing the entire coil layout as flat and on the same plane. A coil with three turns and two vias as represented in [Figure 1](#) is modeled but the model showcases functionality that is applicable to a wide range of geometric configurations.

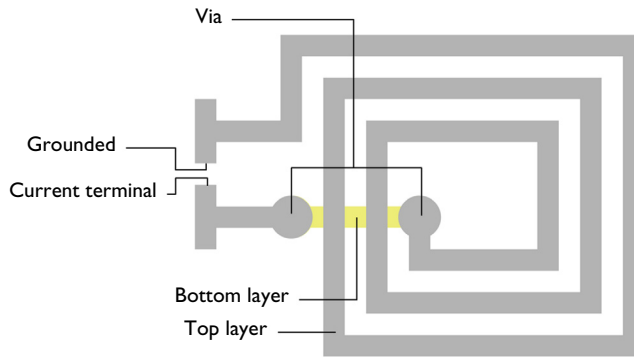

Figure 1: The structure of a simple PCB coil.

## Model Definition

---

The planar PCB coil is made of copper of 0.1 mm thickness. The current flows from one terminal on the top layer to the bottom layer through a via, back to the top layer through a second via and then to the other terminal that is grounded. It is worth noticing that the use of selections has made it possible to automatically identify all the crossings. The PCB substrate is typically made of epoxy resin, providing insulation between conducting layers. Since only the current conduction is of interest, the model uses air material settings (zero conductivity) also in the substrate.

Solving the electric currents, shell problem yields the electric potential drop along the conductor, and the lumped resistance  $R$  is computed according to Ohm's law

$$R = U/I \quad (1)$$

where  $U$  is the electric potential at the current terminal and  $I$  is the injected current (1 A in the current model setup). The computed surface current density flowing in the coil is then applied as the source term in the Amperè's law to compute the magnetic field distribution in the space surrounding the coil.

Note that here the electric currents have been computed for an open path. However, when dealing with magnetic fields, closing the current path is compulsory as current/charge conservation is inherent in Amperè's law. For this purpose, an extra magnetic insulation surface is added between the ground and current terminal. It will carry a reaction (numerically induced) surface current density, making the solution self-consistent with the divergence free nature of currents in Amperè's law.

The inductance can be derived as the ratio of linked magnetic flux to current. For the case of a single coil, the inductance can also be calculated using current and magnetic energy. In particular coil inductance can be expressed as

$$L = 2W_m/I^2 \quad (2)$$

where  $W_m$  is the total magnetic energy in the space.

## Results and Discussion

The model is solved using the default stationary solver. The plot for the electric potential distribution on the surface of the coil is shown in [Figure 2](#). Note that this default plot automatically places the layers in their appropriate positions.

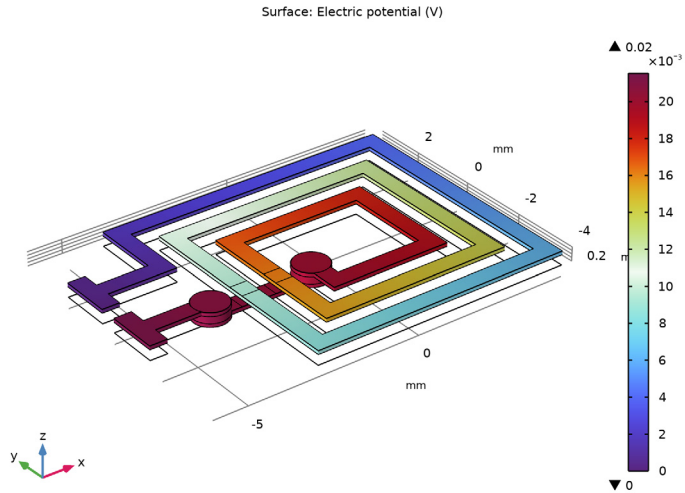

*Figure 2: Electric potential distribution on the surface of the PCB coil.*

The default magnetic field plot is shown in [Figure 3](#). Arrows displaying the surface current density on the coil have been added.

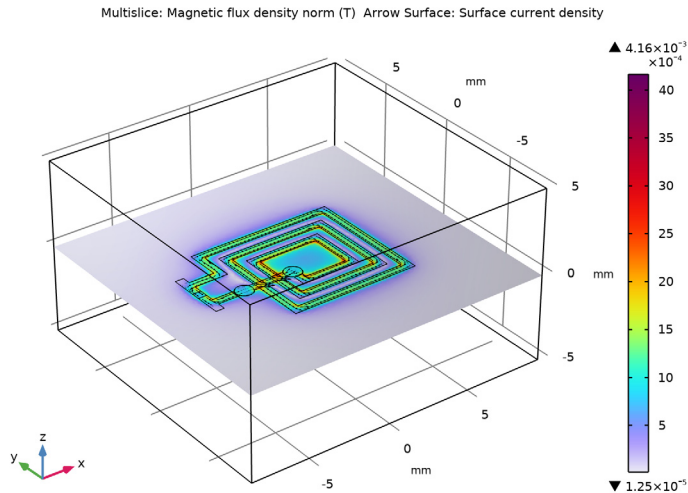

*Figure 3: The simulated surface current density of the coil and the magnetic field around it.*

As a final step, the coil resistance and inductance are evaluated to 21.5 m $\Omega$  and 0.06  $\mu$ H respectively.

---

**Application Library path:** ACDC\_Module/Layered\_Shell/planar\_pcb\_coil

---

### *Modeling Instructions*

---



From the **File** menu, choose **New**.

#### **NEW**



In the **New** window, click  **Model Wizard**.

#### **MODEL WIZARD**

- 1 In the **Model Wizard** window, click  **3D**.
- 2 In the **Select Physics** tree, select **AC/DC>Electric Fields and Currents>Electric Currents in Shells (ecis)**.

- 3 Click **Add**.
- 4 Click  **Study**.
- 5 In the **Select Study** tree, select **General Studies>Stationary**.
- 6 Click  **Done**.

### ADD MATERIAL

- 1 In the **Home** toolbar, click  **Add Material** to open the **Add Material** window.
- 2 Go to the **Add Material** window.
- 3 In the tree, select **Built-in>Copper**.
- 4 Click **Add to Global Materials** in the window toolbar.
- 5 In the tree, select **Built-in>FR4 (Circuit Board)**.
- 6 Right-click and choose **Add to Global Materials**.
- 7 In the **Home** toolbar, click  **Add Material** to close the **Add Material** window.

### GLOBAL DEFINITIONS

#### *Upper Metallization*

- 1 In the **Model Builder** window, under **Global Definitions** right-click **Materials** and choose **Layered Material**.
- 2 In the **Settings** window for **Layered Material**, type Upper Metallization in the **Label** text field.
- 3 Locate the **Layer Definition** section. In the table, enter the following settings:

Layer	Material	Rotation (deg)	Thickness	Mesh elements
Cu_up	Copper (mat1)	0.0	1E-4	2

#### *Lower Metallization*

- 1 Right-click **Materials** and choose **Layered Material**.
- 2 In the **Settings** window for **Layered Material**, type Lower Metallization in the **Label** text field.
- 3 Locate the **Layer Definition** section. In the table, enter the following settings:

Layer	Material	Rotation (deg)	Thickness	Mesh elements
Cu_down	Copper (mat1)	0.0	1E-4	2

#### *Vias Metallization*

- 1 Right-click **Materials** and choose **Layered Material**.

2 In the **Settings** window for **Layered Material**, type Vias Metallization in the **Label** text field.

3 Locate the **Layer Definition** section. In the table, enter the following settings:

Layer	Material	Rotation (deg)	Thickness	Mesh elements
Cu_vias	Copper (mat1)	0.0	2E-4	2

## GEOMETRY I

1 In the **Model Builder** window, under **Component 1 (comp1)** click **Geometry 1**.

2 In the **Settings** window for **Geometry**, locate the **Units** section.

3 From the **Length unit** list, choose **mm**.

*Work Plane 1 (wp1)*

In the **Geometry** toolbar, click  **Work Plane**.

*Work Plane 1 (wp1)>Plane Geometry*

In the **Model Builder** window, click **Plane Geometry**.

*Work Plane 1 (wp1)>Polygon 1 (pol1)*

1 In the **Work Plane** toolbar, click  **Polygon**.

2 In the **Settings** window for **Polygon**, locate the **Coordinates** section.

3 From the **Data source** list, choose **Vectors**.

4 In the **xw** text field, type -6 -6 -5.5 -5.5 -4 -4 4.5 4.5 -3 -3 3.5 3.5 -2 -2 -2 2.5 2.5 -1 -1 -0.5 -0.5 2 2 -1.5 -1.5 -1.5 3 3 -2.5 -2.5 4 4 -3.5 -3.5 -5.5 -5.5 -6.

5 In the **yw** text field, type 0.5 2 2 1.5 1.5 3.5 3.5 -4 -4 2.5 2.5 -3 -3 -2 1.5 1.5 -2 -2 -1 -1 -1.5 -1.5 1 1 -2 -2.5 -2.5 2 2 -3.5 -3.5 3 3 1 1 0.5 0.5.

6 Click  **Build Selected**.

7 Click the  **Zoom Extents** button in the **Graphics** toolbar.

*Work Plane 1 (wp1)>Circle 1 (c1)*

1 In the **Work Plane** toolbar, click  **Circle**.

2 In the **Settings** window for **Circle**, locate the **Size and Shape** section.

3 In the **Radius** text field, type 0.5.

4 Locate the **Position** section. In the **xw** text field, type -0.75.



5 In the **yw** text field, type -0.75.

6 Click  **Build Selected**.

*Work Plane 1 (wp1)>Polygon 2 (pol2)*

- 1 In the **Work Plane** toolbar, click  **Polygon**.
- 2 In the **Settings** window for **Polygon**, locate the **Coordinates** section.
- 3 From the **Data source** list, choose **Vectors**.
- 4 In the **xw** text field, type -6 -6 -5.5 -5.5 -4 -4 -5.5 -5.5.
- 5 In the **yw** text field, type -1.5 0 0 -0.5 -0.5 -1 -1 -1.5.

*Work Plane 1 (wp1)>Circle 2 (c2)*

- 1 In the **Work Plane** toolbar, click  **Circle**.
- 2 In the **Settings** window for **Circle**, locate the **Size and Shape** section.
- 3 In the **Radius** text field, type 0.5.
- 4 Locate the **Position** section. In the **xw** text field, type -3.75.
- 5 In the **yw** text field, type -0.75.
- 6 In the **Work Plane** toolbar, click  **Build All**.

*Work Plane 1 (wp1)>Union 1 (uni1)*

- 1 In the **Work Plane** toolbar, click  **Booleans and Partitions** and choose **Union**.
- 2 Click in the **Graphics** window and then press Ctrl+A to select all objects.

*Work Plane 1 (wp1)>Delete Entities 1 (del1)*

- 1 Right-click **Plane Geometry** and choose **Delete Entities**.



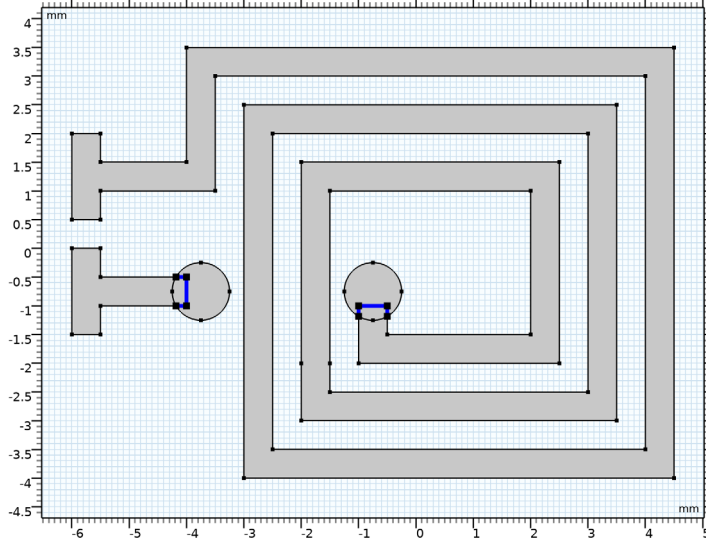

2 On the object **uni1**, select Boundaries 15–17, 38, 39, and 42 only.



*Work Plane 2 (wp2)*

In the **Model Builder** window, right-click **Geometry 1** and choose **Work Plane**.



*Work Plane 2 (wp2)>Polygon 1 (pol1)*

- 1 In the **Work Plane** toolbar, click  **Polygon**.
- 2 In the **Settings** window for **Polygon**, locate the **Coordinates** section.
- 3 From the **Data source** list, choose **Vectors**.
- 4 In the **xw** text field, type -3.5 -1 -1 -3.5.
- 5 In the **yw** text field, type -0.5 -0.5 -1 -1.
- 6 Click  **Build Selected**.
- 7 Click the  **Zoom Extents** button in the **Graphics** toolbar.

*Work Plane 2 (wp2)>Circle 1 (c1)*

- 1 In the **Work Plane** toolbar, click  **Circle**.
- 2 In the **Settings** window for **Circle**, locate the **Size and Shape** section.
- 3 In the **Radius** text field, type 0.5.
- 4 Locate the **Position** section. In the **xw** text field, type -0.75.
- 5 In the **yw** text field, type -0.75.

*Work Plane 2 (wp2)>Circle 2 (c2)*

- 1 In the **Work Plane** toolbar, click  **Circle**.
- 2 In the **Settings** window for **Circle**, locate the **Size and Shape** section.
- 3 In the **Radius** text field, type 0.5.
- 4 Locate the **Position** section. In the **xw** text field, type -3.75.
- 5 In the **yw** text field, type -0.75.
- 6 In the **Work Plane** toolbar, click  **Build All**.

*Work Plane 2 (wp2)>Union 1 (uni1)*

- 1 In the **Work Plane** toolbar, click  **Booleans and Partitions** and choose **Union**.
- 2 Click in the **Graphics** window and then press Ctrl+A to select all objects.

*Work Plane 2 (wp2)>Delete Entities 1 (del1)*

- 1 In the **Model Builder** window, right-click **Plane Geometry** and choose **Delete Entities**.
- 2 On the object **uni1**, select Boundaries 1–3 and 6–8 only.

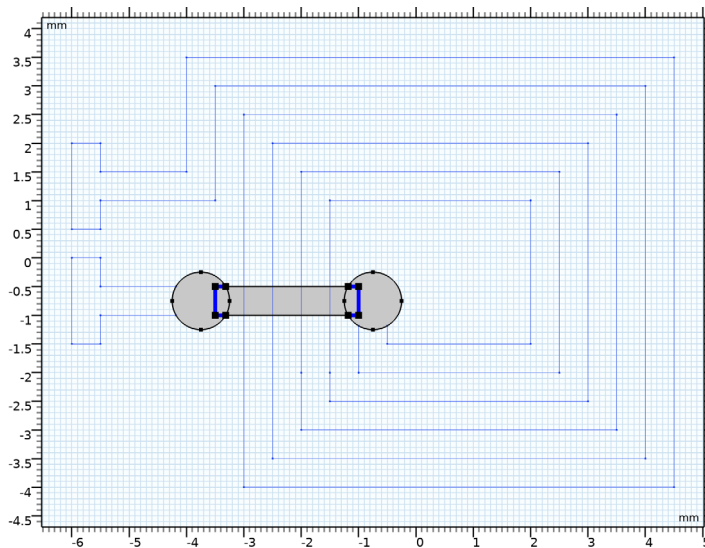

*Work Plane 3 (wp3)*

In the **Model Builder** window, right-click **Geometry 1** and choose **Work Plane**.

*Work Plane 3 (wp3)>Rectangle 1 (r1)*

- 1 In the **Work Plane** toolbar, click  **Rectangle**.
- 2 In the **Settings** window for **Rectangle**, locate the **Size and Shape** section.

- 3 In the **Width** text field, type 0.5.
- 4 In the **Height** text field, type 0.5.
- 5 Locate the **Position** section. In the **xw** text field, type -6.

#### *Upper Layer*

- 1 In the **Model Builder** window, under **Component 1 (comp1)>Geometry 1** click **Work Plane 1 (wp1)**.
- 2 In the **Settings** window for **Work Plane**, type Upper Layer in the **Label** text field.
- 3 Locate the **Selections of Resulting Entities** section. Find the **Cumulative selection** subsection. Click **New**.
- 4 In the **New Cumulative Selection** dialog box, type Top in the **Name** text field.
- 5 Click **OK**.

#### *Lower Layer*

- 1 In the **Model Builder** window, under **Component 1 (comp1)>Geometry 1** click **Work Plane 2 (wp2)**.
- 2 In the **Settings** window for **Work Plane**, type Lower Layer in the **Label** text field.
- 3 Locate the **Selections of Resulting Entities** section. Find the **Cumulative selection** subsection. Click **New**.
- 4 In the **New Cumulative Selection** dialog box, type Bottom in the **Name** text field.
- 5 Click **OK**.

#### *Magnetic Insulation Layer*

- 1 In the **Model Builder** window, under **Component 1 (comp1)>Geometry 1** click **Work Plane 3 (wp3)**.
- 2 In the **Settings** window for **Work Plane**, type Magnetic Insulation Layer in the **Label** text field.
- 3 Locate the **Selections of Resulting Entities** section. Find the **Cumulative selection** subsection. Click **New**.
- 4 In the **New Cumulative Selection** dialog box, type Insulation in the **Name** text field.
- 5 Click **OK**.



Now add a block that will constitute the domain in which to solve for the magnetic field around the coil.

#### *Block 1 (blk1)*

- 1 In the **Geometry** toolbar, click  **Block**.

- 2 In the **Settings** window for **Block**, locate the **Size and Shape** section.
- 3 In the **Width** text field, type 18.
- 4 In the **Depth** text field, type 17.
- 5 In the **Height** text field, type 10.
- 6 Locate the **Position** section. From the **Base** list, choose **Center**.
- 7 Click  **Build Selected**.

*Form Union (fin)*

- 1 In the **Geometry** toolbar, click  **Build All**.
- 2 Click the  **Zoom Extents** button in the **Graphics** toolbar.

## DEFINITIONS

*Hide for Geometry 1*

- 1 In the **Model Builder** window, expand the **Component 1 (comp1)>Definitions** node.
- 2 Right-click **View 1** and choose **Hide for Geometry**.
- 3 In the **Settings** window for **Hide for Geometry**, locate the **Selection** section.
- 4 From the **Geometric entity level** list, choose **Boundary**.
- 5 On the object **fin**, select Boundaries 1, 2, and 4 only.

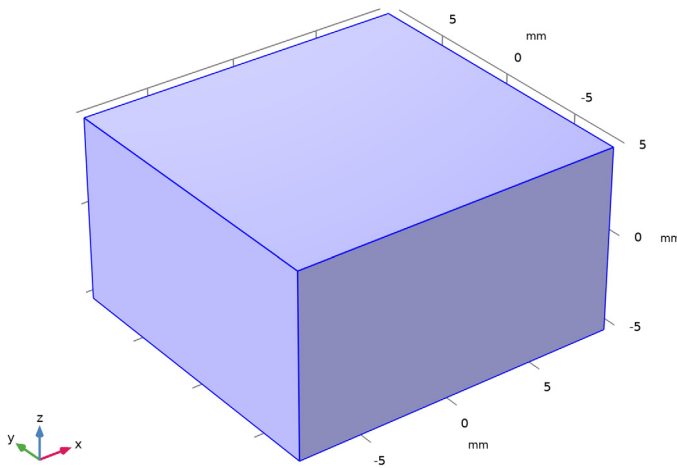



## GEOMETRY I

### Vias

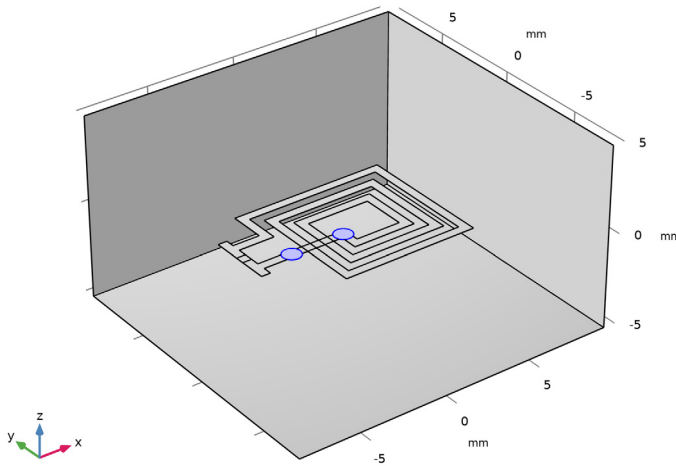
- 1 In the **Geometry** toolbar, click  **Selections** and choose **Explicit Selection**.
- 2 In the **Settings** window for **Explicit Selection**, type Vias in the **Label** text field.
- 3 Locate the **Entities to Select** section. From the **Geometric entity level** list, choose **Boundary**.
- 4 On the object **fin**, select Boundaries 9 and 17 only.



### PCB



- 1 In the **Geometry** toolbar, click  **Selections** and choose **Union Selection**.
- 2 In the **Settings** window for **Union Selection**, locate the **Geometric Entity Level** section.
- 3 From the **Level** list, choose **Boundary**.
- 4 In the **Label** text field, type PCB.
- 5 Locate the **Input Entities** section. Click  **Add**.
- 6 In the **Add** dialog box, in the **Selections to add** list, choose **Top** and **Bottom**.
- 7 Click **OK**.

### Intersections and Vias



- 1 In the **Geometry** toolbar, click  **Selections** and choose **Intersection Selection**.

- 2 In the **Settings** window for **Intersection Selection**, locate the **Geometric Entity Level** section.
- 3 From the **Level** list, choose **Boundary**.
- 4 In the **Label** text field, type **Intersections** and **Vias**.
- 5 Locate the **Input Entities** section. Click **+ Add**.
- 6 In the **Add** dialog box, in the **Selections to intersect** list, choose **Top** and **Bottom**.
- 7 Click **OK**.

#### *Intersections*

- 1 In the **Geometry** toolbar, click  **Selections** and choose **Difference Selection**.
- 2 In the **Settings** window for **Difference Selection**, locate the **Geometric Entity Level** section.
- 3 From the **Level** list, choose **Boundary**.
- 4 In the **Label** text field, type **Intersections**.
- 5 Locate the **Input Entities** section. Click **+ Add**.
- 6 In the **Add** dialog box, select **Intersections and Vias** in the **Selections to add** list.
- 7 Click **OK**.
- 8 In the **Settings** window for **Difference Selection**, locate the **Input Entities** section.
- 9 Click **+ Add**.
- 10 In the **Add** dialog box, select **Vias** in the **Selections to subtract** list.
- 11 Click **OK**.
- 12 In the **Geometry** toolbar, click  **Build All**.

#### **ADD MATERIAL**

- 1 In the **Home** toolbar, click  **Add Material** to open the **Add Material** window.
- 2 Go to the **Add Material** window.
- 3 In the tree, select **Built-in>Air**.
- 4 Click the right end of the **Add to Component** split button in the window toolbar.
- 5 From the menu, choose **Component 1 (comp1)**.
- 6 In the **Home** toolbar, click  **Add Material** to close the **Add Material** window.

#### **MATERIALS**

##### *Air (mat3)*

- 1 In the **Settings** window for **Material**, locate the **Geometric Entity Selection** section.

- 2 From the **Geometric entity level** list, choose **Domain**.
- 3 From the **Selection** list, choose **All domains**.

#### *Upper Mtallization*

- 1 In the **Model Builder** window, right-click **Materials** and choose **Layers> Layered Material Stack**.
- 2 In the **Settings** window for **Layered Material Stack**, type Upper Mtallization in the **Label** text field.
- 3 Locate the **Boundary Selection** section. From the **Selection** list, choose **Top**.
- 4 Locate the **Orientation and Position** section. From the **Position** list, choose **Bottom side on boundary**.

#### *Backing Under Upper Metallization*

- 1 Right-click **Upper Mtallization** and choose **Layered Material**.
- 2 In the **Settings** window for **Layered Material**, locate the **Layer Definition** section.
- 3 In the table, enter the following settings:

<b>Layer</b>	<b>Material</b>	<b>Rotation (deg)</b>	<b>Thickness (m)</b>	<b>Mesh elements</b>
Backing	FR4 (Circuit Board) (mat2)	0.0	3E-4	2

- 4 In the **Label** text field, type Backing Under Upper Metallization.
- 5 Right-click **Backing Under Upper Metallization** and choose **Move Up**.

#### *Upper Metallization*

- 1 In the **Model Builder** window, under **Component 1 (comp1)>Materials> Upper Mtallization (stlmat1)** click **Layered Material Link 1 (stlmat1.stlmat1)**.
- 2 In the **Settings** window for **Layered Material Link**, type Upper Metallization in the **Label** text field.

#### *Lower mMetallization*

- 1 In the **Model Builder** window, under **Component 1 (comp1)** right-click **Materials** and choose **Layers>Layered Material Stack**.
- 2 In the **Settings** window for **Layered Material Stack**, type Lower mMetallization in the **Label** text field.
- 3 Locate the **Boundary Selection** section. From the **Selection** list, choose **Bottom**.
- 4 Locate the **Orientation and Position** section. From the **Position** list, choose **Bottom side on boundary**.

### *Lower Metallization*

- 1 In the **Model Builder** window, click **Layered Material Link 1 (stlmat2.stllmat1)**.
- 2 In the **Settings** window for **Layered Material Link**, locate the **Link Settings** section.
- 3 From the **Material** list, choose **Lower Metallization (lmat2)**.
- 4 In the **Label** text field, type Lower Metallization.

### *Intersections*

- 1 In the **Model Builder** window, under **Component 1 (comp1)** right-click **Materials** and choose **Layers>Layered Material Stack**.
- 2 In the **Settings** window for **Layered Material Stack**, type Intersections in the **Label** text field.
- 3 Locate the **Boundary Selection** section. From the **Selection** list, choose **Intersections**.
- 4 Locate the **Orientation and Position** section. From the **Position** list, choose **Bottom side on boundary**.

### *Lower Metallization*

- 1 In the **Model Builder** window, click **Layered Material Link 1 (stlmat3.stllmat1)**.
- 2 In the **Settings** window for **Layered Material Link**, locate the **Link Settings** section.
- 3 From the **Material** list, choose **Lower Metallization (lmat2)**.
- 4 In the **Label** text field, type Lower Metallization.

### *Intersection Insulator*

- 1 In the **Model Builder** window, right-click **Intersections (stlmat3)** and choose **Layered Material**.
- 2 In the **Settings** window for **Layered Material**, type Intersection Insulator in the **Label** text field.
- 3 Locate the **Layer Definition** section. In the table, enter the following settings:

<b>Layer</b>	<b>Material</b>	<b>Rotation (deg)</b>	<b>Thickness (m)</b>	<b>Mesh elements</b>
Insulator	FR4 (Circuit Board) (mat2)	0.0	2E-4	2

### *Upper Metallization*

- 1 Right-click **Intersections (stlmat3)** and choose **Layered Material Link**.
- 2 In the **Settings** window for **Layered Material Link**, type Upper Metallization in the **Label** text field.



### *Vias*

- 1 In the **Model Builder** window, under **Component 1 (comp1)** right-click **Materials** and choose **Layers>Layered Material Stack**.
- 2 In the **Settings** window for **Layered Material Stack**, locate the **Boundary Selection** section.
- 3 From the **Selection** list, choose **Vias**.
- 4 In the **Label** text field, type **Vias**.
- 5 Locate the **Orientation and Position** section. From the **Position** list, choose **Bottom side on boundary**.

### *Lower Metallization*

- 1 In the **Model Builder** window, under **Component 1 (comp1)>Materials>Vias (stlmat4)** click **Layered Material Link 1 (stlmat4.stlmat1)**.
- 2 In the **Settings** window for **Layered Material Link**, type **Lower Metallization** in the **Label** text field.
- 3 Locate the **Link Settings** section. From the **Material** list, choose **Lower Metallization (lmat2)**.

### *Vias Metallization*

- 1 In the **Model Builder** window, right-click **Vias (stlmat4)** and choose **Layered Material Link**.
- 2 In the **Settings** window for **Layered Material Link**, locate the **Link Settings** section.
- 3 From the **Material** list, choose **Vias Metallization (lmat3)**.
- 4 In the **Label** text field, type **Vias Metallization**.

### *Upper Metallization*

- 1 Right-click **Vias (stlmat4)** and choose **Layered Material Link**.
- 2 In the **Settings** window for **Layered Material Link**, type **Upper Metallization** in the **Label** text field.

## **ELECTRIC CURRENTS IN SHELLS (ECIS)**

- 1 In the **Model Builder** window, under **Component 1 (comp1)** click **Electric Currents in Shells (ecis)**.
- 2 In the **Settings** window for **Electric Currents in Shells**, locate the **Boundary Selection** section.
- 3 From the **Selection** list, choose **PCB**.
- 4 Locate the **Shell Properties** section. From the **Shell type** list, choose **Layered shell**.

### Conductive Shell 1

In the **Model Builder** window, expand the **Component 1 (comp1)>Electric Currents in Shells (ecis)>Conductive Shell 1** node, then click **Conductive Shell 1**.

### Terminal 1

- 1 In the **Physics** toolbar, click  **Attributes** and choose **Terminal**.
- 2 In the **Settings** window for **Terminal**, locate the **Edge Selection** section.
- 3 In the list, select **90 (not applicable)**.
- 4 From the **Selection** list, choose **Manual**.
- 5 Select Edge 12 only.
- 6 Locate the **Terminal** section. In the  $I_0$  text field, type 1.

### Ground 1

- 1 In the **Physics** toolbar, click  **Edges** and choose **Ground**.
- 2 In the **Settings** window for **Ground**, locate the **Edge Selection** section.
- 3 From the **Selection** list, choose **Manual**.
- 4 Select Edge 14 only.

### Insulating Layer 1

- 1 In the **Physics** toolbar, click  **Boundaries** and choose **Insulating Layer**.
- 2 In the **Settings** window for **Insulating Layer**, locate the **Boundary Selection** section.
- 3 From the **Selection** list, choose **All boundaries**.
- 4 Locate the **Shell Properties** section. Specify the **Selection** vector as

---

√	Backing - Backing Under Upper Metallization
	Cu_up - Upper Metallization

---

### Insulating Layer 2

- 1 In the **Physics** toolbar, click  **Boundaries** and choose **Insulating Layer**.
- 2 In the **Settings** window for **Insulating Layer**, locate the **Boundary Selection** section.
- 3 From the **Selection** list, choose **All boundaries**.
- 4 Locate the **Shell Properties** section. From the **Layer** list, choose **Intersections (stlmat3)**.
- 5 Specify the **Selection** vector as

---

	Cu_down - Lower Metallization
--	-------------------------------

---

√	Insulator - Intersection Insulator
	Cu_up - Upper Metallization

#### *Continuity 1a*

- 1 In the **Physics** toolbar, click  **Edges** and choose **Continuity**.
- 2 In the **Settings** window for **Continuity**, locate the **Layer Selection** section.
- 3 From the **Source** list, choose **Upper Mtallization (stlmat1)**.
- 4 From the **Destination** list, choose **Intersections (stlmat3)**.

#### *Continuity 2*

- 1 In the **Physics** toolbar, click  **Edges** and choose **Continuity**.
- 2 In the **Settings** window for **Continuity**, locate the **Layer Selection** section.
- 3 From the **Source** list, choose **Upper Mtallization (stlmat1)**.
- 4 From the **Destination** list, choose **Vias (stlmat4)**.



#### *Continuity 3*

- 1 In the **Physics** toolbar, click  **Edges** and choose **Continuity**.
- 2 In the **Settings** window for **Continuity**, locate the **Layer Selection** section.
- 3 From the **Source** list, choose **Lower mMetallization (stlmat2)**.
- 4 From the **Destination** list, choose **Intersections (stlmat3)**.

#### *Continuity 4*

- 1 In the **Physics** toolbar, click  **Edges** and choose **Continuity**.
- 2 In the **Settings** window for **Continuity**, locate the **Layer Selection** section.
- 3 From the **Source** list, choose **Lower mMetallization (stlmat2)**.
- 4 From the **Destination** list, choose **Vias (stlmat4)**.

#### **ADD PHYSICS**

- 1 In the **Physics** toolbar, click  **Add Physics** to open the **Add Physics** window.
- 2 Go to the **Add Physics** window.
- 3 In the tree, select **AC/DC>Electromagnetic Fields>Magnetic Fields (mf)**.
- 4 Click **Add to Component 1** in the window toolbar.
- 5 In the **Physics** toolbar, click  **Add Physics** to close the **Add Physics** window.

## MAGNETIC FIELDS (MF)

### Surface Current Density 1

- 1 Right-click **Component 1 (comp1)>Magnetic Fields (mf)** and choose **Surface Current Density**.
- 2 In the **Settings** window for **Surface Current Density**, locate the **Surface Current Density** section.
- 3 Specify the  $\mathbf{J}_{s0}$  vector as

ecis.JsX	x
ecis.JsY	y
ecis.JsZ	z

- 4 Locate the **Boundary Selection** section. From the **Selection** list, choose **PCB**.

### Magnetic Insulation 2

- 1 In the **Physics** toolbar, click  **Boundaries** and choose **Magnetic Insulation**.
- 2 In the **Settings** window for **Magnetic Insulation**, locate the **Boundary Selection** section.
- 3 From the **Selection** list, choose **Insulation**.

## MESH 1

### Free Tetrahedral 1

In the **Mesh** toolbar, click  **Free Tetrahedral**.

### Size 1

- 1 Right-click **Free Tetrahedral 1** and choose **Size**.
- 2 In the **Settings** window for **Size**, locate the **Element Size** section.
- 3 Click the **Custom** button.
- 4 Locate the **Geometric Entity Selection** section. From the **Geometric entity level** list, choose **Boundary**.
- 5 From the **Selection** list, choose **PCB**.
- 6 Locate the **Element Size Parameters** section. Select the **Maximum element size** check box.
- 7 In the associated text field, type 0.35.
- 8 Click  **Build All**.

## STUDY 1

In the **Home** toolbar, click  **Compute**.

## RESULTS

### *Electric Potential (ecis)*

Electric potential distribution on the surface of the PCB coil.

### *Multislice 1*

- 1 In the **Model Builder** window, expand the **Results>Magnetic Flux Density Norm (mf)** node, then click **Multislice 1**.
- 2 In the **Settings** window for **Multislice**, locate the **Multiplane Data** section.
- 3 Find the **x-planes** subsection. From the **Entry method** list, choose **Number of planes**.
- 4 In the **Planes** text field, type 0.
- 5 Find the **y-planes** subsection. From the **Entry method** list, choose **Number of planes**.
- 6 In the **Planes** text field, type 0.
- 7 In the **Magnetic Flux Density Norm (mf)** toolbar, click  **Plot**.

### *Streamline Multislice 1*

In the **Model Builder** window, under **Results>Magnetic Flux Density Norm (mf)** right-click **Streamline Multislice 1** and choose **Delete**.

### *Arrow Surface 1*

- 1 In the **Model Builder** window, right-click **Magnetic Flux Density Norm (mf)** and choose **Arrow Surface**.
- 2 In the **Settings** window for **Arrow Surface**, click **Replace Expression** in the upper-right corner of the **Expression** section. From the menu, choose **Component 1 (comp1)>Magnetic Fields>mf.scu1.js0x, ...,mf.scu1.js0z - Surface current density**.
- 3 Locate the **Coloring and Style** section. Select the **Scale factor** check box.
- 4 In the associated text field, type 2e-4.
- 5 Locate the **Arrow Positioning** section. In the **Number of arrows** text field, type 1e4.
- 6 Locate the **Coloring and Style** section. From the **Color** list, choose **Black**.
- 7 In the **Magnetic Flux Density Norm (mf)** toolbar, click  **Plot**.

The simulated surface current density of the coil and the magnetic field around it.

### *Global Evaluation 1*

- 1 In the **Results** toolbar, click  **Global Evaluation**.
- 2 In the **Settings** window for **Global Evaluation**, click **Add Expression** in the upper-right corner of the **Expressions** section. From the menu, choose **Component 1 (comp1)>Electric Currents in Shells>Terminals>ecis.V0\_1 - Terminal voltage - V**.

3 Locate the **Expressions** section. In the table, enter the following settings:

Expression	Unit	Description
$ecis.V0_1/ecis.I0_1$	mΩ	Resistance
$2*mf.intWm/ecis.I0_1^2$	uH	Inductance

4 Click  **Evaluate**.