



# Self Inductance and Mutual Inductance Between Single Conductors

## Introduction

---

Two coils consisting of a single turn in a concentric coplanar arrangement are studied. Using a DC (steady state) analysis and an AC (frequency domain) analysis, the self inductance of each coil and the mutual inductance between the two coils are computed using different approaches and are compared with analytical values. The two coils are excited in turns to compute all the elements of the inductance matrix.

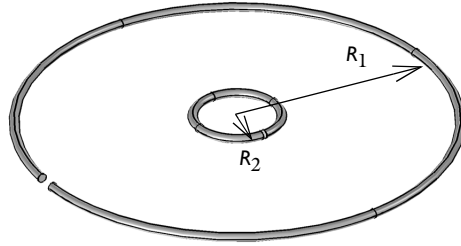

*Figure 1: Two concentric coplanar single-turn loops of wire. In each analysis, one of the two coils is excited, acting as the primary, while the other acts as the secondary.*

## Model Definition

---

The physical situation being modeled is shown in [Figure 1](#). The two coils have radius  $R_1 = 100$  mm and  $R_2 = 10$  mm and are placed in a concentric and coplanar configuration. The wire radius is  $r_0 = 1$  mm. The coils are here modeled in the 2D axisymmetric space, assuming no physical variation around the centerline. The coils are excited in turn with a prescribed current of 1 A.

In the limit as  $R_1 \gg R_2 \gg r_0$ , the analytic expression for the mutual inductance between the two coils is:

$$L_{21} = \frac{\pi\mu_0 R_2^2}{2R_1}$$

where  $\mu_0$  is the permeability of free space. This analytic expression is used to verify the accuracy of the model.

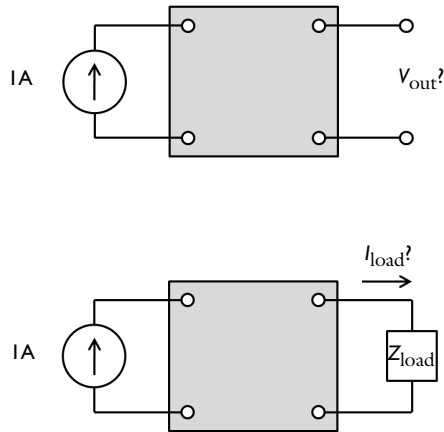

*Figure 2: The concentric coils can be considered as a four-terminal device. The output can either be an open circuit, or a load can be applied.*

Another way to consider this system is as a four-terminal device, as shown in [Figure 2](#). A known current applied at the input terminals of the device, the primary coil, induces a voltage difference across the output terminals, the secondary coil. The objective of the AC model is to compute the voltage difference at the output for the open circuit case, and the induced currents for the closed circuit case.

The two concentric coils are modeled in a 2D axisymmetric sense, as shown schematically in [Figure 3](#). The modeling domain is surrounded by a region of infinite elements, which is a way to truncate a domain which stretches to infinity. Although the thickness of the Infinite Element Domain is finite, it can be thought of as a domain of infinite extent.

The coils are both modeled using the **Coil** feature, which can be thought of as introducing an excitation across an infinitesimal slit in an otherwise continuous torus. Since each coil has a single turn and is made up of conductive material, the **Single conductor** model is used in the Coil feature. The feature can be used to excite the coil in all cases: the open circuit

case, the closed torus case, as well as to model an external load. The primary coil is excited by specifying a current of 1 A.

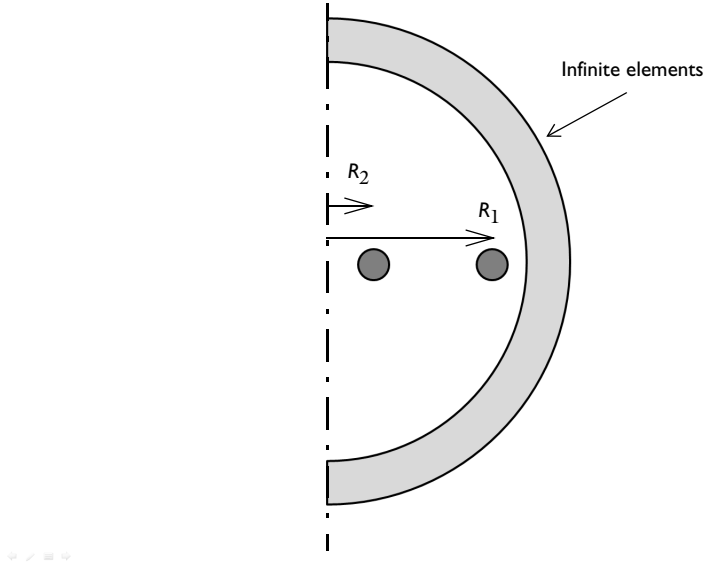

Figure 3: A schematic representation of the 2D axisymmetric model of the concentric coils.

Although induced currents exist only if there is some variation in the driving current with respect to time, it is still possible to evaluate the inductance for this case from a DC analysis. Self ( $L_{11}$ ) and mutual ( $L_{12}$ ) inductances are defined as the total magnetic flux  $\mathbf{B}$  passing through a surface whose edges define respectively the primary and the secondary coil. That is:

$$L_{11} = \frac{\iint_{S_1} \mathbf{B} \cdot \mathbf{n} dS}{I_1} \quad L_{12} = \frac{\iint_{S_2} \mathbf{B} \cdot \mathbf{n} dS}{I_1}$$

Where  $I_1$  is the current passing through the primary coil,  $\mathbf{n}$  is the vector normal to the surface, and the integral is taken over the surface defined by the coil. Since the  $\mathbf{B}$ -field is computed from the magnetic vector potential:

$$\mathbf{B} = \nabla \times \mathbf{A}$$

It is possible to use Stokes' theorem, which states that a surface integral of the curl of a field equals the line integral over the rim of the surface:

$$L_{11} = \frac{\iint_{S_1} (\nabla \times \mathbf{A}) \cdot \mathbf{n} dS}{I_1} = \frac{\oint_{\Gamma_1} \mathbf{A} \cdot \mathbf{t} dl}{I_1}$$

$$L_{12} = \frac{\oint_{\Gamma_2} \mathbf{A} \cdot \mathbf{t} dl}{I_1}$$

Where  $\mathbf{t}$  is the unit tangent vector around the rim of the surface.

When solving the Magnetic Fields interface in a Stationary study step, these quantities are computed automatically for the coils present in the model. Cycling the feed over the coils (leaving zero current on the others) it is possible to extract the whole inductance matrix.

An alternative approach to the computation of the self inductance in stationary situation is the energy method, which is based on the total magnetic energy in the system. With this approach, the self inductance is defined as:

$$L_{11} = \frac{2}{I_1^2} \int_{\Omega} W_m d\Omega$$

where  $W_m$  is the magnetic energy density, the current  $I_1$  is the current feeding the system and  $I_2$  is equal to zero. Correspondingly,  $L_{22}$  can be determined by feeding only the second coil.

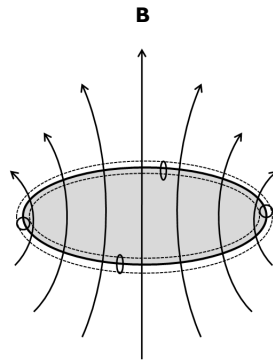

*Figure 4: The mutual inductance in the secondary coil can be evaluated by taking the surface integral of the magnetic flux through the coil, or the path integral of the magnetic vector potential.*

For the AC case, a 1 kHz sinusoidally time-varying current is driving the primary coil. This can either induce currents in the secondary coil or induce a voltage difference if the coil is being modeled as an open circuit.

The secondary coil uses the Coil feature to model both the open circuit and the closed circuit case. To model the open circuit case, the current through the coil is specified to be 0 A. The Coil feature introduces a coil voltage that causes no current to flow.

On the other hand, to model the closed circuit case, the voltage drop across the coil is fixed at 0 V. Although this seems to imply a short circuit, the reactance of the copper coil is inherently included, so the case being modeled is analogous to a closed continuous loop of wire.

In the AC case, there is no analytic solution to compare against. At any nonzero frequency, capacitive effects start to appear, and the skin effect also starts to alter the effective resistance of the coils. The magnitude of these effects can only be evaluated with a frequency domain model. Although the DC case does provide good predictions of the behavior at low frequencies, it cannot completely predict behavior at higher frequencies. As additional physical objects such as cores are introduced, the need for a frequency domain model for accurate prediction becomes greater.

## Results and Discussion

The DC magnetic flux is plotted in Figure 5. In the stationary case, the self and mutual inductances are computed automatically by integrating the magnetic vector potential as detailed above. The values are available as postprocessing variables, `mf.LCoil_1` and `mf.L_2_1`, which can be evaluated in a Global Evaluation node. The computed self inductance is compared with the one computed using the energy method, while the mutual inductance is verified against the analytical value, which is applicable in the limit  $R_1 \gg R_2 \gg r_0$ .

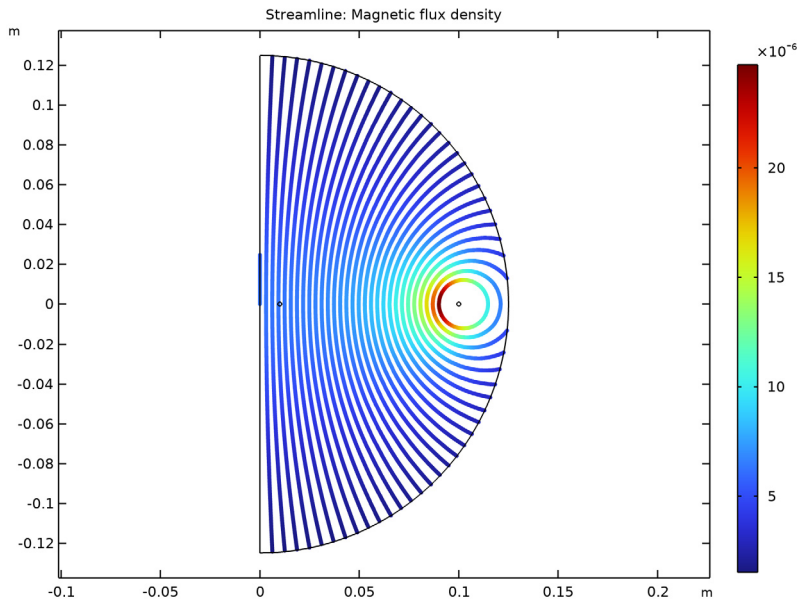

Figure 5: Magnetic flux lines for the DC case.

A second stationary study is performed after switching the excitation in order to compute the self inductance for the inner coil and the mutual inductance between the outer and the inner coil.

For the time harmonic case, the induced currents of the secondary coil (connected to an open circuit) is plotted in Figure 6. The average of the induced currents over the cross section is zero, that is, there is no net current flow through the coil.

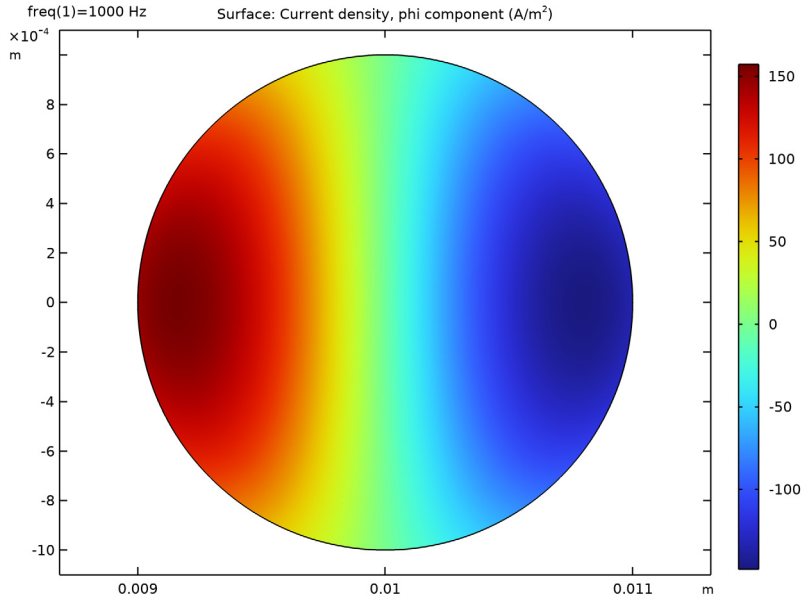

Figure 6: Induced currents in the coil for the open circuit case, the average of the current flow over the cross section is zero.

In the time harmonic (frequency domain) case, the mutual inductance is computed in as:

$$L_{12} = \frac{V_2}{i\omega I_1} \quad (1)$$

The computed mutual inductance is  $1.973 - 0.004i$  nH. The small imaginary component is due to the resistive effects, that is due to finite conductivity there are eddy current losses in the wires and the coil AC impedance ( $V/I$ ), though mainly reactive, has a small resistive part.



The induced currents of the secondary coil for the closed circuit case is plotted in [Figure 7](#). The skin effect is clearly visible; the current is being driven to the boundaries of the domain.

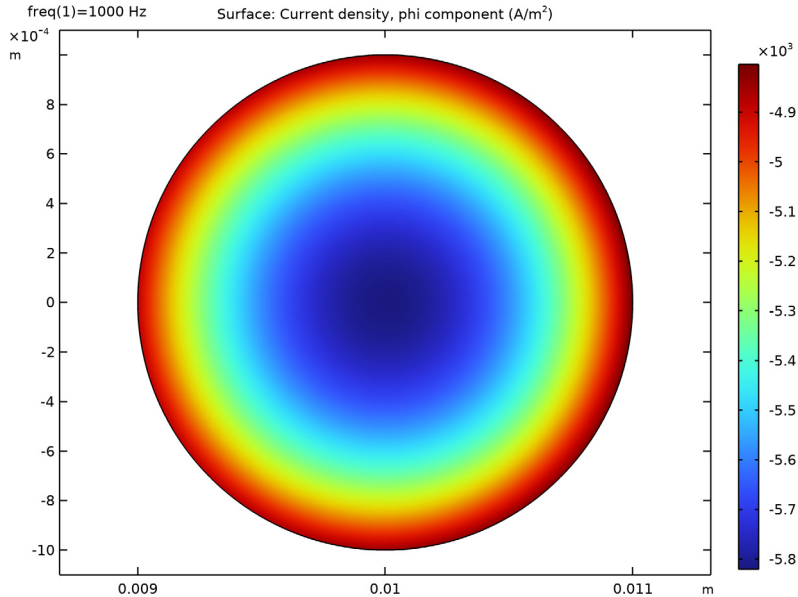

*Figure 7: Induced currents in the coil for the closed circuit case.*

The total induced current around the secondary coil is  $-0.01675 - 0.02677i$ , the imaginary component implies a reactive current. This value is verified by an estimate computed from DC values:

$$I_2 = -i\omega \frac{L_{21}}{Z_2}$$

where  $L_{21}$  is the mutual inductance and  $Z_2 = R_2 + i\omega L_2$  is the impedance of the inner coil.

---

**Application Library path:** ACDC\_Module/Inductive\_Devices\_and\_Coils/  
mutual\_inductance

---

## Modeling Instructions



---

From the **File** menu, choose **New**.

### NEW

In the **New** window, click  **Model Wizard**.

### MODEL WIZARD

- 1 In the **Model Wizard** window, click  **2D Axisymmetric**.
- 2 In the **Select Physics** tree, select **AC/DC>Electromagnetic Fields>Magnetic Fields (mf)**.
- 3 Click **Add**.
- 4 Click  **Study**.
- 5 In the **Select Study** tree, select **General Studies>Stationary**.
- 6 Click  **Done**.

### GLOBAL DEFINITIONS

#### Parameters 1

- 1 In the **Model Builder** window, under **Global Definitions** click **Parameters 1**.
- 2 In the **Settings** window for **Parameters**, locate the **Parameters** section.
- 3 In the table, enter the following settings:

Name	Expression	Value	Description
r_wire	1[mm]	0.001 m	Radius, wire
R1	100[mm]	0.1 m	Radius, outer coil
R2	10[mm]	0.01 m	Radius, inner coil
M	$(\mu_0\_const \cdot \pi \cdot R_2^2) / (2 \cdot R_1)$	1.9739E-9 H	Analytic mutual inductance
I1	1[A]	1 A	Current, outer coil
I2	0[A]	0 A	Current, inner coil

Here,  $\mu_0\_const$  a predefined COMSOL constant for the permeability in vacuum.

### GEOMETRY 1

Create a circle for the simulation domain. Define a layer in the circle where you will assign the Infinite Element Domain.

### Circle 1 (c1)

- 1 In the **Geometry** toolbar, click  **Circle**.
- 2 In the **Settings** window for **Circle**, locate the **Size and Shape** section.
- 3 In the **Sector angle** text field, type 180.
- 4 In the **Radius** text field, type  $1.75 \cdot R1$ .
- 5 Locate the **Rotation Angle** section. In the **Rotation** text field, type -90.
- 6 Click to expand the **Layers** section. In the table, enter the following settings:

Layer name	Thickness (m)
Layer 1	50 [mm]

Create a circle for the outer coil.

### Circle 2 (c2)

- 1 In the **Geometry** toolbar, click  **Circle**.
- 2 In the **Settings** window for **Circle**, locate the **Size and Shape** section.
- 3 In the **Radius** text field, type  $r_{\text{wire}}$ .
- 4 Locate the **Position** section. In the **r** text field, type  $R1$ .

Then, create a circle for the inner coil.

### Circle 3 (c3)

- 1 In the **Geometry** toolbar, click  **Circle**.
- 2 In the **Settings** window for **Circle**, locate the **Size and Shape** section.
- 3 In the **Radius** text field, type  $r_{\text{wire}}$ .
- 4 Locate the **Position** section. In the **r** text field, type  $R2$ .

Define the Infinite Element Domain to apply a coordinate transformation that mathematically stretches the layer to infinity. The **Physics-Controlled Mesh** creates a **Swept mesh** inside the **Infinite Elements** domains.

## DEFINITIONS

### Infinite Element Domain 1 (ie1)

- 1 In the **Definitions** toolbar, click  **Infinite Element Domain**.

2 Select Domains 1 and 3 only.

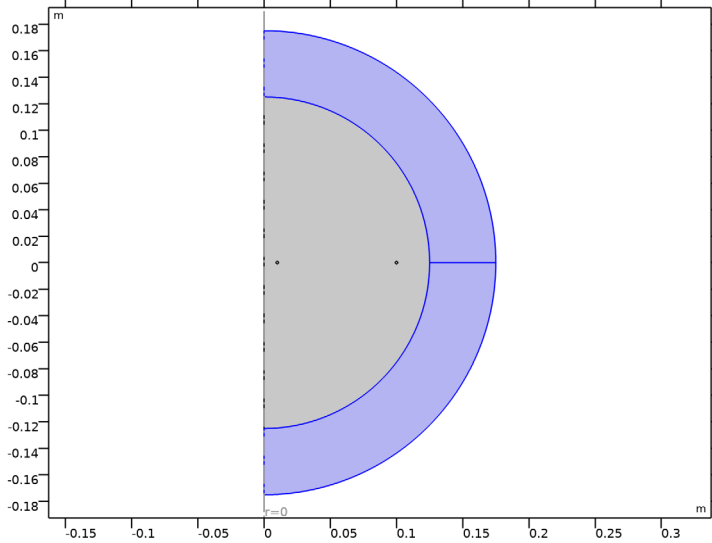

### MAGNETIC FIELDS (MF)

Now, set up the physics. Assign a **Coil** feature on the outer and the inner coil. The outer coil will be initially fed with a current  $I_1=1$  [A].

1 Click the  **Zoom In** button in the **Graphics** toolbar.

#### Coil 1

1 In the **Model Builder** window, under **Component 1 (comp1)** right-click **Magnetic Fields (mf)** and choose the domain setting **Coil**.

2 Select Domain 5 only.

3 In the **Settings** window for **Coil**, locate the **Coil** section.

4 In the  $I_{\text{coil}}$  text field, type I1.

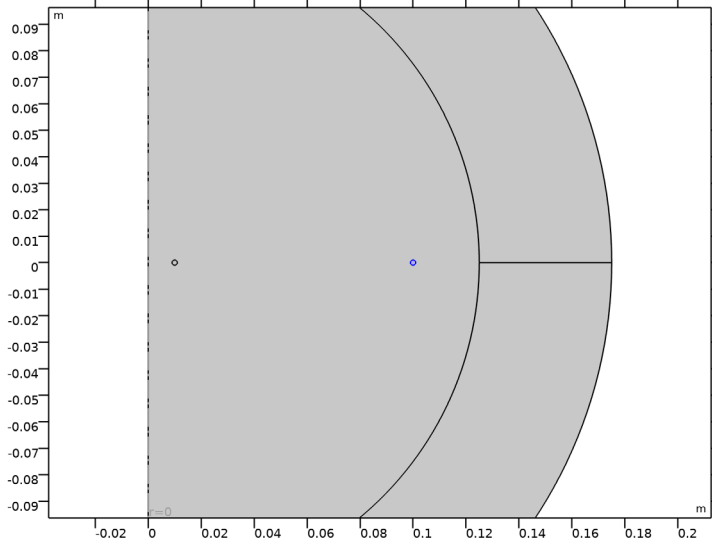

Specify  $I_2=0[\text{A}]$  current for the **Coil** feature assigned to the inner coil to model the open circuit case.

*Coil 2*

1 In the **Physics** toolbar, click  **Domains** and choose **Coil**.

2 Select Domain 4 only.

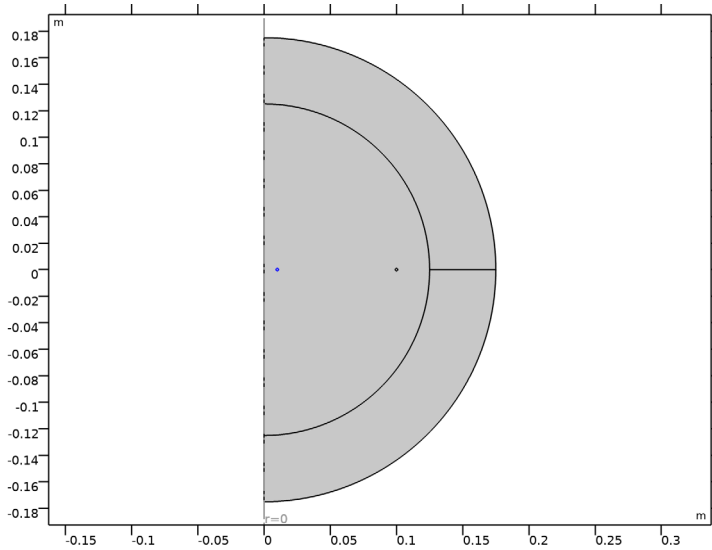

3 In the **Settings** window for **Coil**, locate the **Coil** section.

4 In the  $I_{\text{coil}}$  text field, type I2.

## MATERIALS

Next, assign material properties. Use **Air** for all domains.

### ADD MATERIAL

1 In the **Home** toolbar, click  **Add Material** to open the **Add Material** window.

2 Go to the **Add Material** window.

3 In the tree, select **Built-in>Air**.

4 Click **Add to Component** in the window toolbar.

## MATERIALS

*Air (mat1)*

Then, override the coil domains with copper.

### ADD MATERIAL

1 Go to the **Add Material** window.

2 In the tree, select **AC/DC>Copper**.

3 Click **Add to Component** in the window toolbar.

4 In the **Home** toolbar, click  **Add Material** to close the **Add Material** window.

## MATERIALS

*Copper (mat2)*

Select Domains 4 and 5 only.

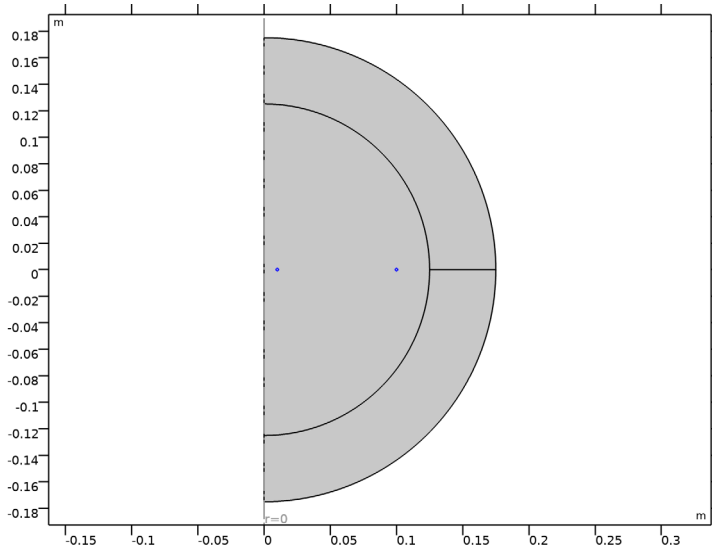

## MESH 1

1 Click the  **Zoom Extents** button in the **Graphics** toolbar.

- 2 In the **Model Builder** window, under **Component 1 (comp1)** right-click **Mesh 1** and choose **Build All**.

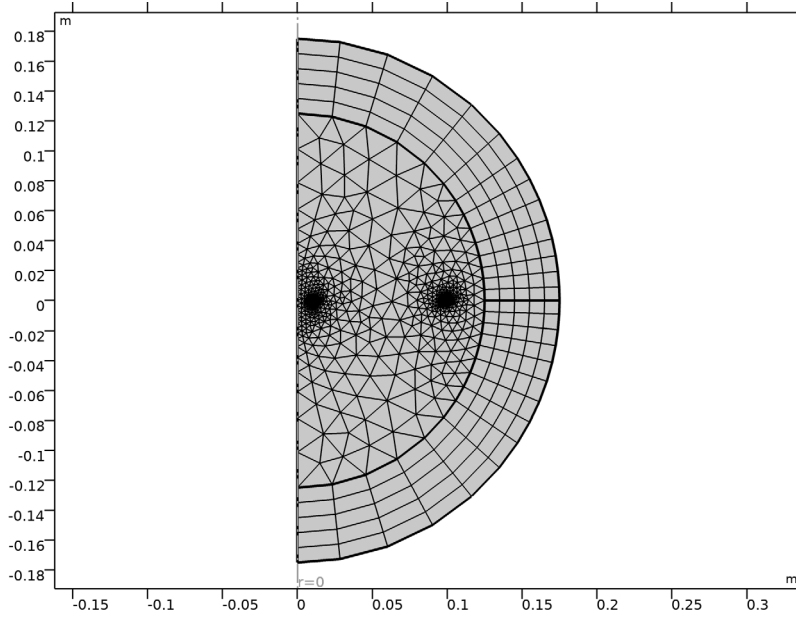

Solve the first case where the outer coil (named 1) is fed and the inner (named 2) is open.

### STUDY 1

- 1 In the **Model Builder** window, click **Study 1**.
- 2 In the **Settings** window for **Study**, locate the **Study Settings** section.
- 3 Clear the **Generate default plots** check box.
- 4 In the **Home** toolbar, click **Compute**.

### RESULTS

In the **Model Builder** window, expand the **Results** node.

*Study 1/Solution 1 (sol1)*

Select only the domains not part of the Infinite Element Domain for better magnetic flux visualization.

- 1 In the **Model Builder** window, expand the **Results>Datasets** node, then click **Study 1/Solution 1 (sol1)**.



### Selection

- 1 In the **Results** toolbar, click  **Attributes** and choose **Selection**.
- 2 In the **Settings** window for **Selection**, locate the **Geometric Entity Selection** section.
- 3 From the **Geometric entity level** list, choose **Domain**.
- 4 Select Domains 2, 4, and 5 only.

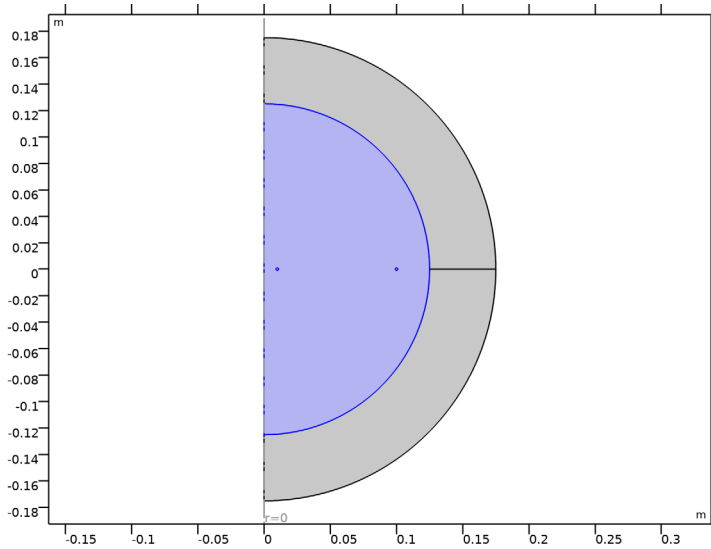

### Magnetic Flux Density DC

- 1 In the **Results** toolbar, click  **2D Plot Group**.
- 2 In the **Settings** window for **2D Plot Group**, type Magnetic Flux Density DC in the **Label** text field.

### Streamline 1

- 1 Right-click **Magnetic Flux Density DC** and choose **Streamline**.
- 2 In the **Settings** window for **Streamline**, locate the **Streamline Positioning** section.
- 3 From the **Positioning** list, choose **Starting-point controlled**.
- 4 From the **Entry method** list, choose **Coordinates**.
- 5 In the **r** text field, type  $\text{range}(0, 0.9 \cdot R1 / 29, 0.9 \cdot R1)$ .
- 6 In the **z** text field, type 0.
- 7 Locate the **Coloring and Style** section. Find the **Line style** subsection. From the **Type** list, choose **Tube**.

### Color Expression 1

1 Right-click **Streamline 1** and choose **Color Expression**.

2 Click the  **Zoom Extents** button in the **Graphics** toolbar.

The resulting plot shows the magnetic flux lines for the DC case as in [Figure 5](#).

Evaluate the self inductance of the external coil and the mutual inductance of the outer coil with respect to the inner. Some additional quantities are also computed to verify the results.

### Global Evaluation 1

1 In the **Results** toolbar, click  **Global Evaluation**.

2 In the **Settings** window for **Global Evaluation**, locate the **Expressions** section.

3 Use the **Add Expression** button or enter the information manually in order to obtain the following **Expressions** table:

Expression	Unit	Description
mf.LCoil_1	nH	External coil inductance
2*mf.intWm/1[A^2]	nH	Energy estimate for external coil inductance
mf.L_2_1	nH	Computed mutual inductance
M	nH	Analytical mutual inductance

4 Click  **Evaluate**.

Next, compute the self inductance of the inner coil and the mutual inductance of the inner coil with respect to the outer. Start by switching the currents in the coils.

## GLOBAL DEFINITIONS

### Parameters 1

1 In the **Model Builder** window, under **Global Definitions** click **Parameters 1**.



2 In the **Settings** window for **Parameters**, locate the **Parameters** section.

3 In the table, enter the following settings:

Name	Expression	Value	Description
I1	0[A]	0 A	Current, outer coil
I2	1[A]	1 A	Current, inner coil

Now add and solve a second study for this case. The solution previously computed will still be available in Study 1.

## ADD STUDY

- 1 In the **Home** toolbar, click  **Add Study** to open the **Add Study** window.
- 2 Go to the **Add Study** window.
- 3 Find the **Studies** subsection. In the **Select Study** tree, select **General Studies>Stationary**.
- 4 Click **Add Study** in the window toolbar.
- 5 In the **Home** toolbar, click  **Add Study** to close the **Add Study** window.

## STUDY 2

- 1 In the **Model Builder** window, click **Study 2**.
- 2 In the **Settings** window for **Study**, locate the **Study Settings** section.
- 3 Clear the **Generate default plots** check box.
- 4 In the **Home** toolbar, click  **Compute**.

The quantities of interest are evaluated in the following steps.

## RESULTS

### *Global Evaluation 2*

- 1 In the **Results** toolbar, click  **Global Evaluation**.
- 2 In the **Settings** window for **Global Evaluation**, locate the **Data** section.
- 3 From the **Dataset** list, choose **Study 2/Solution 2 (sol2)**.
- 4 Locate the **Expressions** section. Use the **Add Expression** button or enter the information manually in order to obtain the following **Expressions** table:

Expression	Unit	Description
mf.LCoil_2	nH	Internal coil inductance
$2*mf.intWm/1[A^2]$	nH	Energy estimate for internal coil inductance
mf.L_1_2	nH	Computed mutual inductance
M	nH	Analytical mutual inductance

- 5 Click  next to  **Evaluate**, then choose **New Table**.

## TABLE

- 1 Go to the **Table** window.

Self and mutual inductance variables as computed above are derived via concatenated flux, which is defined as the line integral of the magnetic vector potential along the coil. This approach gives the best accuracy.

For simple geometries like the present one, concatenated flux can be also computed explicitly using its definition as the integral of magnetic flux through a surface, although this approach usually gives less accurate results.

## RESULTS

### *Cut Line 2D 1*

- 1 In the **Results** toolbar, click  **Cut Line 2D**.
- 2 In the **Settings** window for **Cut Line 2D**, locate the **Line Data** section.
- 3 In row **Point 2**, set **r** to R2.

### *Cut Line 2D 2*

- 1 In the **Results** toolbar, click  **Cut Line 2D**.
- 2 In the **Settings** window for **Cut Line 2D**, locate the **Line Data** section.
- 3 In row **Point 2**, set **r** to R1.

### *Line Integration 1*

- 1 In the **Results** toolbar, click  **More Derived Values** and choose **Integration>Line Integration**.
- 2 In the **Settings** window for **Line Integration**, locate the **Data** section.
- 3 From the **Dataset** list, choose **Cut Line 2D 1**.
- 4 Locate the **Expressions** section. In the table, enter the following settings:



Expression	Unit	Description
mf.Bz/I1	nH	

- 5 Click  next to  **Evaluate**, then choose **New Table**.

## TABLE

Go to the **Table** window.

### *Line Integration 2*

- 1 Right-click **Line Integration 1** and choose **Duplicate**.
- 2 In the **Settings** window for **Line Integration**, locate the **Data** section.
- 3 From the **Dataset** list, choose **Cut Line 2D 2**.
- 4 Click  next to  **Evaluate**, then choose **Table 3 - Line Integration 1**.

### *Cut Line 2D 1*

- 1 In the **Model Builder** window, under **Results>Datasets** click **Cut Line 2D 1**.

- 2 In the **Settings** window for **Cut Line 2D**, locate the **Data** section.
- 3 From the **Dataset** list, choose **Study 2/Solution 2 (sol2)**.

*Cut Line 2D 2*

- 1 In the **Model Builder** window, click **Cut Line 2D 2**.
- 2 In the **Settings** window for **Cut Line 2D**, locate the **Data** section.
- 3 From the **Dataset** list, choose **Study 2/Solution 2 (sol2)**.

*Line Integration 1*

- 1 In the **Model Builder** window, under **Results>Derived Values** click **Line Integration 1**.
- 2 In the **Settings** window for **Line Integration**, locate the **Expressions** section.
- 3 In the table, enter the following settings:

Expression	Unit	Description
mf.Bz/I2	nH	

- 4 Click ▼ next to  **Evaluate**, then choose **Table 3 - Line Integration 1**.

*Line Integration 2*

- 1 In the **Model Builder** window, click **Line Integration 2**.
- 2 In the **Settings** window for **Line Integration**, locate the **Expressions** section.
- 3 In the table, enter the following settings:

Expression	Unit	Description
mf.Bz/I2	nH	

- 4 Click ▼ next to  **Evaluate**, then choose **Table 3 - Line Integration 1**.

Experimentally, mutual inductance is measured by feeding an AC signal in the primary coil and measuring the voltage induced in the open-circuit secondary coil. This procedure can be simulated by using a Frequency Domain study step. Start by setting the AC feed on Coil 1 and the open circuit (zero current) condition on Coil 2.

**GLOBAL DEFINITIONS**



*Parameters 1*

- 1 In the **Model Builder** window, under **Global Definitions** click **Parameters 1**.
- 2 In the **Settings** window for **Parameters**, locate the **Parameters** section.

3 In the table, enter the following settings:

Name	Expression	Value	Description
I1	1[A]	1 A	Current, outer coil
I2	0[A]	0 A	Current, inner coil

### ADD STUDY

- 1 In the **Home** toolbar, click  **Add Study** to open the **Add Study** window.
- 2 Go to the **Add Study** window.
- 3 Find the **Studies** subsection. In the **Select Study** tree, select **General Studies> Frequency Domain**.
- 4 Click **Add Study** in the window toolbar.
- 5 In the **Home** toolbar, click  **Add Study** to close the **Add Study** window.

### STUDY 3

#### *Step 1: Frequency Domain*

- 1 In the **Settings** window for **Frequency Domain**, locate the **Study Settings** section.
- 2 In the **Frequencies** text field, type 1 [kHz].
- 3 In the **Model Builder** window, click **Study 3**.
- 4 In the **Settings** window for **Study**, locate the **Study Settings** section.
- 5 Clear the **Generate default plots** check box.
- 6 In the **Home** toolbar, click  **Compute**.

### RESULTS

#### *Study 3/Solution 3 (sol3)*

Select the inner coil domain.

- 1 In the **Model Builder** window, under **Results>Datasets** click **Study 3/Solution 3 (sol3)**.



#### *Selection*

- 1 In the **Results** toolbar, click  **Attributes** and choose **Selection**.
- 2 In the **Settings** window for **Selection**, locate the **Geometric Entity Selection** section.
- 3 From the **Geometric entity level** list, choose **Domain**.
- 4 Select Domain 4 only.

### Current Open Circuit

- 1 In the **Results** toolbar, click  **2D Plot Group**.
- 2 In the **Settings** window for **2D Plot Group**, type Current Open Circuit in the **Label** text field.
- 3 Locate the **Data** section. From the **Dataset** list, choose **Study 3/Solution 3 (sol3)**.
- 4 Locate the **Plot Settings** section. From the **View** list, choose **New view**.

### Surface 1

- 1 Right-click **Current Open Circuit** and choose **Surface**.
- 2 In the **Settings** window for **Surface**, click **Replace Expression** in the upper-right corner of the **Expression** section. From the menu, choose **Component 1 (comp1)>Magnetic Fields>Currents and charge>Current density - A/m<sup>2</sup>>mf.jphi - Current density, phi component**.
- 3 In the **Current Open Circuit** toolbar, click  **Plot**.
- 4 Click the  **Zoom Extents** button in the **Graphics** toolbar.  
Compare the reproduced plot with [Figure 6](#).

Evaluate the mutual inductance using [Equation 1](#).

### Global Evaluation 3

- 1 In the **Results** toolbar, click  **Global Evaluation**.
- 2 In the **Settings** window for **Global Evaluation**, locate the **Data** section.
- 3 From the **Dataset** list, choose **Study 3/Solution 3 (sol3)**.
- 4 Locate the **Expressions** section. In the table, enter the following settings:

Expression	Unit	Description
$mf.VCoil\_2/1[A]/mf.iomega$	nH	

- 5 Click  **Evaluate**.

Finally, simulate the system as it was a transformer with a short-circuited secondary winding. Specify a voltage of 0 V for the **Coil** feature assigned to the inner coil to model the short-circuit condition.



## MAGNETIC FIELDS (MF)

### Coil 2

- 1 In the **Model Builder** window, under **Component 1 (comp1)>Magnetic Fields (mf)** click **Coil 2**.
- 2 In the **Settings** window for **Coil**, locate the **Coil** section.

- 3 From the **Coil excitation** list, choose **Voltage**.
- 4 In the  $V_{\text{coil}}$  text field, type 0.

#### ADD STUDY

- 1 In the **Home** toolbar, click  **Add Study** to open the **Add Study** window.
- 2 Go to the **Add Study** window.
- 3 Find the **Studies** subsection. In the **Select Study** tree, select **General Studies>Frequency Domain**.
- 4 Click **Add Study** in the window toolbar.
- 5 In the **Home** toolbar, click  **Add Study** to close the **Add Study** window.

#### STUDY 4

##### *Step 1: Frequency Domain*

- 1 In the **Settings** window for **Frequency Domain**, locate the **Study Settings** section.
- 2 In the **Frequencies** text field, type 1 [kHz].
- 3 In the **Model Builder** window, click **Study 4**.
- 4 In the **Settings** window for **Study**, locate the **Study Settings** section.
- 5 Clear the **Generate default plots** check box.
- 6 In the **Home** toolbar, click  **Compute**.

#### RESULTS

##### *Study 4/Solution 4 (sol4)*

Select the inner coil domain.

- 1 In the **Model Builder** window, under **Results>Datasets** click **Study 4/Solution 4 (sol4)**.

##### *Selection*

- 1 In the **Results** toolbar, click  **Attributes** and choose **Selection**.
- 2 In the **Settings** window for **Selection**, locate the **Geometric Entity Selection** section.
- 3 From the **Geometric entity level** list, choose **Domain**.
- 4 Select Domain 4 only.



##### *Current Closed Circuit*

- 1 In the **Results** toolbar, click  **2D Plot Group**.
- 2 In the **Settings** window for **2D Plot Group**, type Current Closed Circuit in the **Label** text field.



- 3 Locate the **Data** section. From the **Dataset** list, choose **Study 4/Solution 4 (sol4)**.
- 4 Locate the **Plot Settings** section. From the **View** list, choose **View 2D 2**.

#### Surface 1

- 1 Right-click **Current Closed Circuit** and choose **Surface**.
- 2 In the **Settings** window for **Surface**, click **Replace Expression** in the upper-right corner of the **Expression** section. From the menu, choose **Component 1 (comp1)>Magnetic Fields>Currents and charge>Current density - A/m<sup>2</sup>>mf.Jphi - Current density, phi component**.
- 3 In the **Current Closed Circuit** toolbar, click  **Plot**.
- 4 Click the  **Zoom Extents** button in the **Graphics** toolbar.

The reproduced plot should look like [Figure 7](#).

Evaluate the total induced current on the inner (secondary) coil. This quantity is related to static quantities, being in the simplest approximation  $i\omega M/(R_2 + i\omega L_2)$  times 1 [A].

#### Global Evaluation 4

- 1 In the **Results** toolbar, click  **Global Evaluation**.
- 2 In the **Settings** window for **Global Evaluation**, locate the **Data** section.
- 3 From the **Dataset** list, choose **Study 4/Solution 4 (sol4)**.
- 4 Locate the **Expressions** section. In the table, enter the following settings:

Expression	Unit	Description
mf.ICoil_2	A	Coil current
$-mf.i\omega * \text{withsol}('sol1', mf.L_{2\_1}) / (\text{withsol}('sol2', mf.RCoil_2) + \text{withsol}('sol2', mf.LCoil_2)) * mf.i\omega * mf.ICoil_1$	A	

The `withsol` operator is used to evaluate a quantity using a different study or solution step.

- 5 Click  **Evaluate**.

