



Homopolar Generator

Introduction

A homopolar generator is composed of an electrically conductive rotating disc placed in a uniform magnetic field that is perpendicular to the plane of rotation. The motion of the conductor through the static magnetic field induces Lorentz currents in the disc. By connecting the outside rim of the disc to the center via a stationary conductor, a significant current can be generated. This example models the flow of current through the copper conductor and the rotating disc.

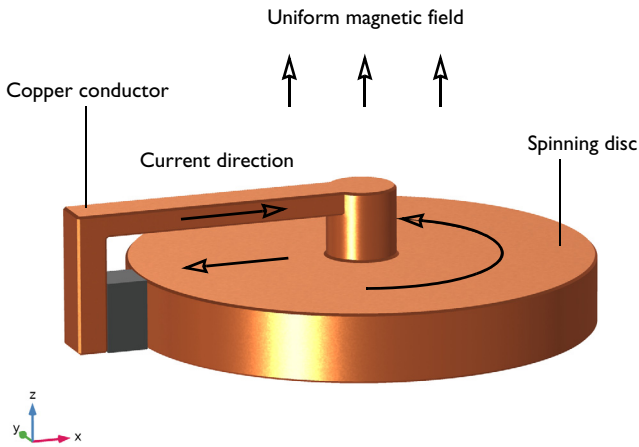

Figure 1: Model illustration of a homopolar generator. A spinning disc is placed in a uniform magnetic field.

Model Definition

The application is formulated in 3D and solved using a stationary formulation. The rotating conductive disc of radius 10 cm and height 3 cm is placed in a space with a uniform magnetic flux density of 1 T. Figure 1 shows the current direction, the rotational direction, and the direction of the magnetic field. The center of the disc is connected to its rim via a conductor, which forms a closed, solenoidal path for the circulation of electric current. This application also illustrates the proper use of a Lorentz term to model the rotation of the disc.

For a disc rotating about the z -axis, with an angular velocity ω , the velocity, v , at a point (x, y) is given by

$$\mathbf{v} = \omega(-y, x, 0)$$

The use of a Lorentz term to include the motion is valid in a situation when the moving domain does not contain any magnetic sources, such as currents or magnetization (fixed or induced), that move along with the material, and when the moving domains are unbounded and invariant in the direction of the motion. In this example, the induced current distribution is stationary and does not follow the rotation of the disc.

Results and Discussion

The model is solved using a stationary solver at an angular speed of 1200 rpm. A total current of about 45.159 kA flows through the conductor. [Figure 2](#) shows the streamline plot of an induced eddy current density in the rotating disc and the conductor.

[Figure 3](#) shows a volume plot of the magnetic flux density (total) and a streamline plot of the induced magnetic flux density.

[Figure 4](#) illustrates the direction of the current density in the rotating disc and the conductor. In this figure, the current is flowing from the center of the disc to its rim (inside the disc). The current direction is reversed if either the rotational direction or the direction of the uniform magnetic field is changed.

Finally, [Figure 5](#) displays a volume plot of the resistive loss in the copper domains.

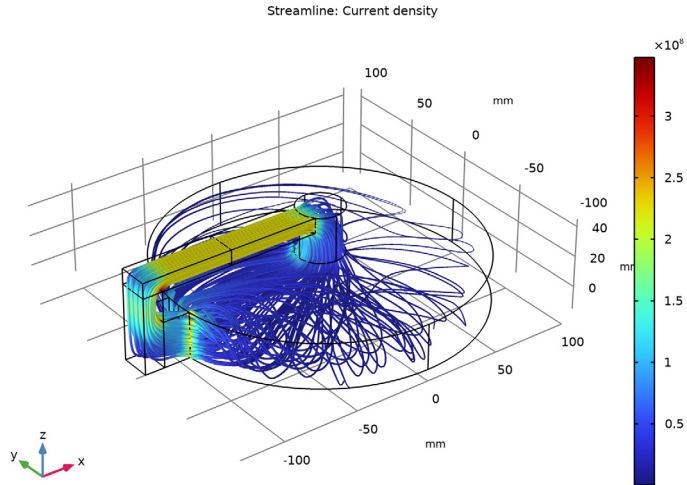

Figure 2: Current density norm in the conducting domains.

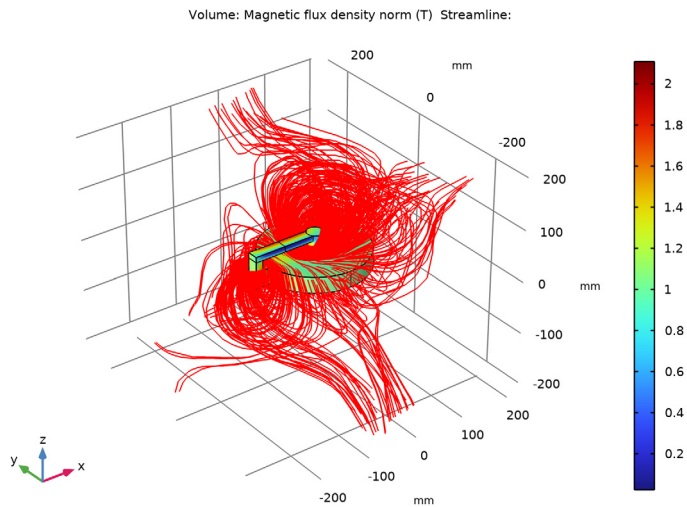

Figure 3: The total magnetic flux density norm (surface plot) and the induced magnetic flux density (streamline plot).

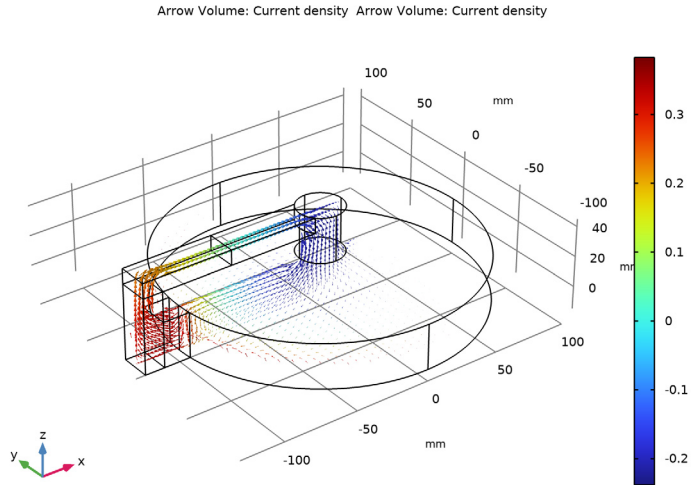

Figure 4: The direction of current in the rotating disc and the conductor.

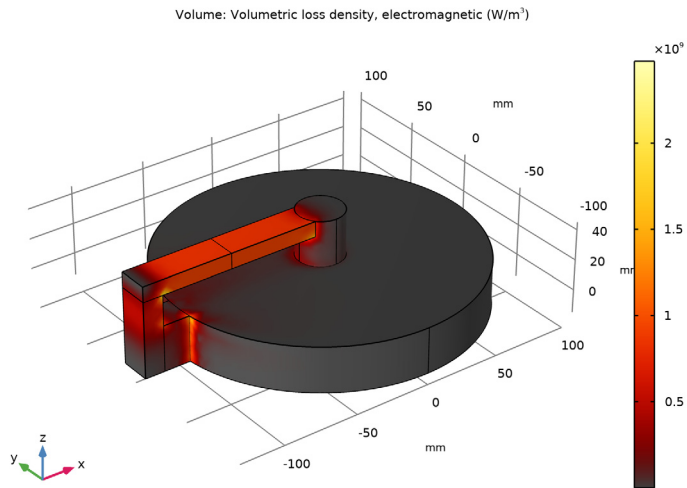



Figure 5: The resistive loss in the rotating disc and the conductor.

Application Library path: ACDC_Module/Motors_and_Actuators/
homopolar_generator



Modeling Instructions

From the **File** menu, choose **New**.

NEW

In the **New** window, click  **Model Wizard**.

MODEL WIZARD

- 1 In the **Model Wizard** window, click  **3D**.
- 2 In the **Select Physics** tree, select **AC/DC>Electromagnetic Fields>Vector Formulations>Magnetic and Electric Fields (mef)**.
- 3 Click **Add**.
- 4 Click  **Study**.
- 5 In the **Select Study** tree, select **General Studies>Stationary**.
- 6 Click  **Done**.

GEOMETRY I

Define the rotational velocity of a copper disc as a global parameter.

GLOBAL DEFINITIONS

Parameters I

- 1 In the **Model Builder** window, under **Global Definitions** click **Parameters I**.
- 2 In the **Settings** window for **Parameters**, locate the **Parameters** section.
- 3 In the table, enter the following settings:



Name	Expression	Value	Description
Bz0	1[Wb/m^2]	1 T	Constant magnetic flux density
RPM	1200[rpm]	20 1/s	Disc speed

Follow the instructions below to construct the model geometry. First, create the geometry of the rotating disc.

GEOMETRY I

- 1 In the **Model Builder** window, under **Component 1 (comp1)** click **Geometry I**.
- 2 In the **Settings** window for **Geometry**, locate the **Units** section.
- 3 From the **Length unit** list, choose **mm**.



Cylinder 1 (cyl1)

- 1 In the **Geometry** toolbar, click  **Cylinder**.
- 2 In the **Settings** window for **Cylinder**, locate the **Size and Shape** section.
- 3 In the **Radius** text field, type 100.
- 4 In the **Height** text field, type 30.
- 5 Locate the **Position** section. In the **z** text field, type -15.
- 6 Click  **Build Selected**.

Cylinder 2 (cyl2)

- 1 Right-click **Cylinder 1 (cyl1)** and choose **Duplicate**.
- 2 In the **Settings** window for **Cylinder**, click  **Build Selected**.

Cylinder 3 (cyl3)

- 1 In the **Geometry** toolbar, click  **Cylinder**.
- 2 In the **Settings** window for **Cylinder**, locate the **Size and Shape** section.
- 3 In the **Radius** text field, type 15.
- 4 In the **Height** text field, type 30.
- 5 Locate the **Position** section. In the **z** text field, type 15.
- 6 Click  **Build Selected**.

Cylinder 4 (cyl4)

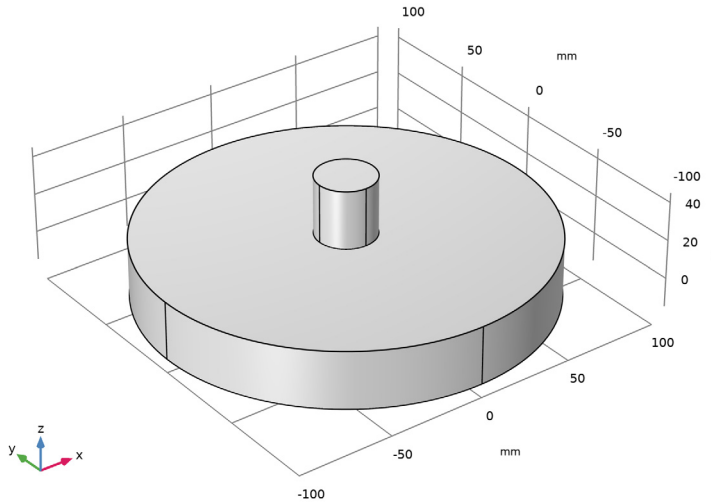

- 1 Right-click **Cylinder 3 (cyl3)** and choose **Duplicate**.

2 In the **Settings** window for **Cylinder**, click  **Build Selected**.



Add the conductor to connect the center of the disc to the rim.

Work Plane 1 (wp1)

- 1 In the **Geometry** toolbar, click  **Work Plane**.
- 2 In the **Settings** window for **Work Plane**, locate the **Plane Definition** section.
- 3 In the **z-coordinate** text field, type 35.
- 4 Locate the **Unite Objects** section. Clear the **Unite objects** check box.
- 5 Click  **Show Work Plane**.

Work Plane 1 (wp1)>Plane Geometry

Click the  **Zoom Extents** button in the **Graphics** toolbar.

Work Plane 1 (wp1)>Rectangle 1 (r1)

- 1 In the **Work Plane** toolbar, click  **Rectangle**.
- 2 In the **Settings** window for **Rectangle**, locate the **Size and Shape** section.
- 3 In the **Width** text field, type 130.
- 4 In the **Height** text field, type 20.
- 5 Locate the **Position** section. In the **xw** text field, type -130.
- 6 In the **yw** text field, type -10.

7 Click to expand the **Layers** section. In the table, enter the following settings:

Layer name	Thickness (mm)
Layer 1	60

8 Clear the **Layers on bottom** check box.

9 Select the **Layers to the left** check box.

10 Click  **Build Selected**.

Work Plane 1 (wp1)>Rectangle 2 (r2)

1 In the **Work Plane** toolbar, click  **Rectangle**.

2 In the **Settings** window for **Rectangle**, locate the **Size and Shape** section.

3 In the **Width** text field, type 13.

4 In the **Height** text field, type 20.

5 Locate the **Position** section. In the **xw** text field, type -130.

6 In the **yw** text field, type -10.

7 Click  **Build Selected**.

Extrude 1 (ext1)

1 In the **Model Builder** window, under **Component 1 (comp1)>Geometry 1** right-click **Work Plane 1 (wp1)** and choose **Extrude**.

2 Select the object **wp1.r1** only.

3 In the **Settings** window for **Extrude**, click  **Build Selected**.

4 Locate the **Distances** section. In the table, enter the following settings:

Distances (mm)
10

Difference 1 (dif1)

1 In the **Geometry** toolbar, click  **Booleans and Partitions** and choose **Difference**.

2 Select the object **ext1** only.



3 In the **Settings** window for **Difference**, locate the **Difference** section.

4 Find the **Objects to subtract** subsection. Click to select the  **Activate Selection** toggle button.

5 Select the object **cyl3** only.



6 Click  **Build Selected**.

Extrude 2 (ext2)

- 1 In the **Geometry** toolbar, click  **Extrude**.
- 2 In the **Settings** window for **Extrude**, click  **Build Selected**.
- 3 Locate the **Distances** section. In the table, enter the following settings:

Distances (mm)
-50

Work Plane 2 (wp2)

- 1 In the **Geometry** toolbar, click  **Work Plane**.
- 2 In the **Settings** window for **Work Plane**, locate the **Plane Definition** section.
- 3 From the **Plane type** list, choose **Face parallel**.
- 4 Click the  **Wireframe Rendering** button in the **Graphics** toolbar.
- 5 On the object **ext2**, select Boundary 6 only.

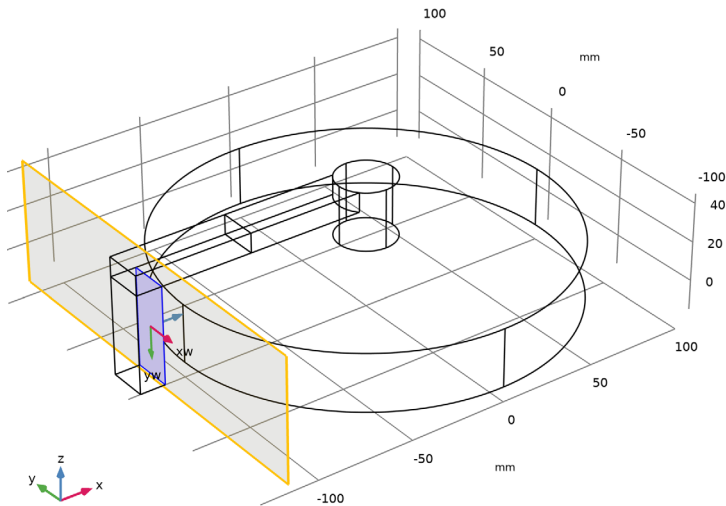

- 6 Click  **Show Work Plane**.

Work Plane 2 (wp2)>Plane Geometry

Click the  **Zoom Extents** button in the **Graphics** toolbar.

Work Plane 2 (wp2)>Rectangle 1 (r1)

- 1 In the **Work Plane** toolbar, click  **Rectangle**.
- 2 In the **Settings** window for **Rectangle**, locate the **Size and Shape** section.



- 3 In the **Width** text field, type 20.
- 4 In the **Height** text field, type 30.
- 5 Locate the **Position** section. In the **xw** text field, type -10.
- 6 In the **yw** text field, type -5.
- 7 Click  **Build Selected**.

Extrude 3 (ext3)

- 1 In the **Model Builder** window, under **Component 1 (comp1)>Geometry 1** right-click **Work Plane 2 (wp2)** and choose **Extrude**.
- 2 In the **Settings** window for **Extrude**, click  **Build Selected**.
- 3 Locate the **Distances** section. In the table, enter the following settings:

Distances (mm)
30



Difference 2 (dif2)

- 1 In the **Geometry** toolbar, click  **Booleans and Partitions** and choose **Difference**.
- 2 Select the object **ext3** only.
- 3 In the **Settings** window for **Difference**, locate the **Difference** section.
- 4 Find the **Objects to subtract** subsection. Click to select the  **Activate Selection** toggle button.
- 5 Select the object **cyll** only.

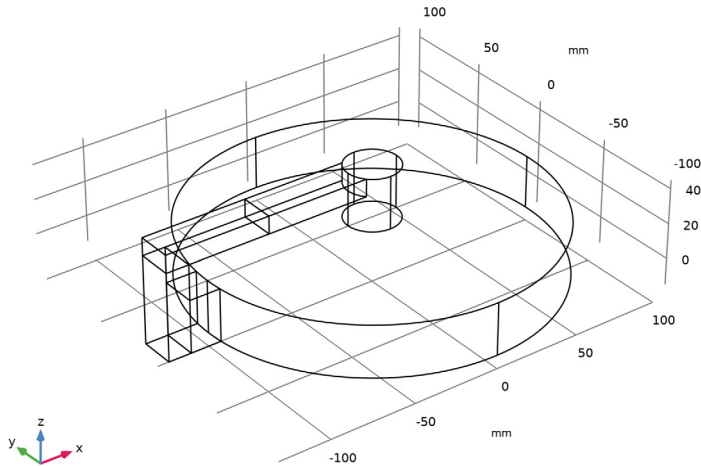
6 Click  **Build Selected.**



Cylinder 5 (cyl5)

- 1 In the **Geometry** toolbar, click  **Cylinder.**
- 2 In the **Settings** window for **Cylinder**, locate the **Size and Shape** section.
- 3 In the **Radius** text field, type 300.
- 4 In the **Height** text field, type 400.
- 5 Locate the **Position** section. In the **z** text field, type -200.
- 6 Click  **Build Selected.**

Form Union (fin)

- 1 In the **Geometry** toolbar, click  **Build All.**
- 2 Click the  **Go to Default View** button in the **Graphics** toolbar.

- 3 Click the  **Wireframe Rendering** button in the **Graphics** toolbar.
The final geometry looks like as shown in the figure below.

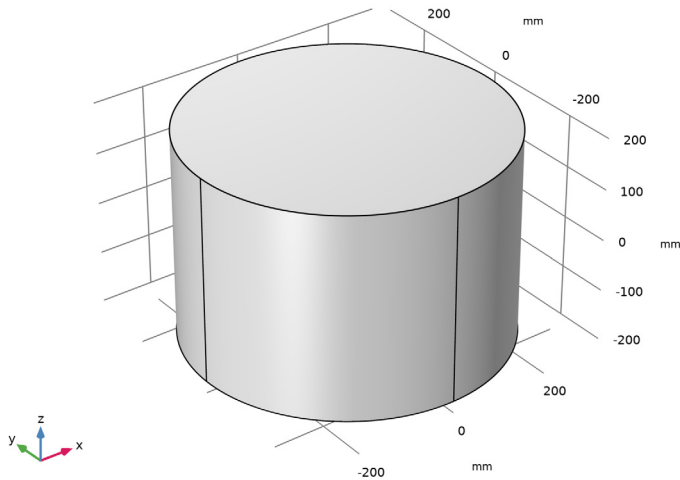

DEFINITIONS

View 1

Hide some outer boundaries to view the rotating disc.

Hide for Physics 1

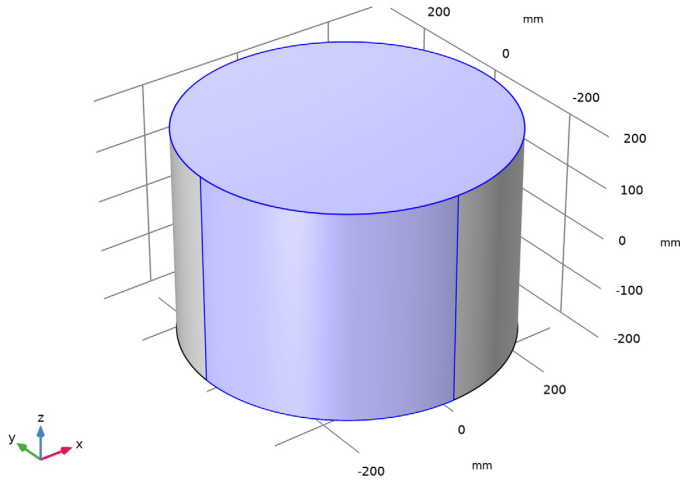

- 1 In the **Model Builder** window, expand the **Component 1 (comp1)>Definitions** node.
- 2 Right-click **View 1** and choose **Hide for Physics**.
- 3 In the **Settings** window for **Hide for Physics**, locate the **Geometric Entity Selection** section.
- 4 From the **Geometric entity level** list, choose **Boundary**.

5 Select Boundaries 1 and 4 only.



Define boundary selections for the exterior boundaries of the outer cylinder. You will use these boundaries to define the uniform magnetic field.

Exterior Boundaries

- 1 In the **Definitions** toolbar, click  **Explicit**.
- 2 In the **Settings** window for **Explicit**, locate the **Input Entities** section.
- 3 From the **Geometric entity level** list, choose **Boundary**.
- 4 Click  **Paste Selection**.
- 5 In the **Paste Selection** dialog box, type 1-4, 38, 43 in the **Selection** text field.
- 6 Click **OK**.
- 7 Right-click **Explicit 1** and choose **Rename**.
- 8 In the **Rename Explicit** dialog box, type Exterior Boundaries in the **New label** text field.
- 9 Click **OK**.

Define the domain selections for the rotating disc.



Rotating Disc

- 1 In the **Definitions** toolbar, click  **Explicit**.
- 2 Select Domains 5 and 7 only.

- 3 Right-click **Explicit 2** and choose **Rename**.
- 4 In the **Rename Explicit** dialog box, type Rotating Disc in the **New label** text field.
- 5 Click **OK**.

Next, assign a selection for the copper domains.

Copper Domains

- 1 In the **Definitions** toolbar, click  **Explicit**.
- 2 In the **Settings** window for **Explicit**, locate the **Input Entities** section.
- 3 Click  **Paste Selection**.
- 4 In the **Paste Selection** dialog box, type 2-7 in the **Selection** text field.
- 5 Click **OK**.
- 6 Right-click **Explicit 3** and choose **Rename**.
- 7 In the **Rename Explicit** dialog box, type Copper Domains in the **New label** text field.
- 8 Click **OK**.

MAGNETIC AND ELECTRIC FIELDS (MEF)

Set up the **Magnetic and Electric Fields** physics. Use **Ampère's Law** for the air domain and the default **Ampère's Law and Current Conservation** feature for the copper domains. Assign the rotational velocity of the rotating disc using a **Velocity (Lorentz Term)** feature.

Ampère's Law 1

- 1 In the **Model Builder** window, under **Component 1 (comp1)** right-click **Magnetic and Electric Fields (mef)** and choose **Ampère's Law**.
- 2 Select Domain 1 only.

Velocity (Lorentz Term) 1

- 1 In the **Physics** toolbar, click  **Domains** and choose **Velocity (Lorentz Term)**.
- 2 In the **Settings** window for **Velocity (Lorentz Term)**, locate the **Domain Selection** section.
- 3 From the **Selection** list, choose **Rotating Disc**.
- 4 Locate the **Velocity (Lorentz Term)** section. Specify the **v** vector as

$-2*\pi*RPM*y$	x
$2*\pi*RPM*x$	y
0	z

Use the **Magnetic Potential** boundary condition on the exterior boundaries to define the uniform magnetic fields in the *z* direction.

Magnetic Potential I



- 1 In the **Physics** toolbar, click  **Boundaries** and choose **Magnetic Potential**.
- 2 In the **Settings** window for **Magnetic Potential**, locate the **Boundary Selection** section.
- 3 From the **Selection** list, choose **Exterior Boundaries**.
- 4 Locate the **Magnetic Potential** section. Specify the A_0 vector as

0	x
Bz_0*x	y
0	z

MATERIALS

Assign materials to the model. First, assign air in the exterior region. Next, specify copper for the remaining domains.

ADD MATERIAL

- 1 In the **Home** toolbar, click  **Add Material** to open the **Add Material** window.
- 2 Go to the **Add Material** window.
- 3 In the tree, select **Built-in>Air**.
- 4 Click **Add to Component** in the window toolbar.
- 5 In the tree, select **AC/DC>Copper**.
- 6 Click **Add to Component** in the window toolbar.
- 7 In the **Home** toolbar, click  **Add Material** to close the **Add Material** window.

MATERIALS

Copper (mat2)

- 1 In the **Settings** window for **Material**, locate the **Geometric Entity Selection** section.
- 2 From the **Selection** list, choose **Copper Domains**.

MESH I

The finite element mesh in the surrounding air domain can be relatively coarse, but the element size in the disc and the conductors must be small enough to resolve the current distribution in the domains.

Size I

In the **Model Builder** window, under **Component I (comp1)** right-click **Mesh I** and choose **Size**.



Size

- 1 In the **Settings** window for **Size**, locate the **Element Size** section.
- 2 From the **Predefined** list, choose **Coarser**.

Size I

- 1 In the **Model Builder** window, click **Size I**.
- 2 In the **Settings** window for **Size**, locate the **Geometric Entity Selection** section.
- 3 From the **Geometric entity level** list, choose **Domain**.
- 4 From the **Selection** list, choose **Copper Domains**.
- 5 Locate the **Element Size** section. Click the **Custom** button.
- 6 Locate the **Element Size Parameters** section. Select the **Maximum element size** check box.
- 7 In the associated text field, type 10.

Free Tetrahedral I

- 1 In the **Mesh** toolbar, click  **Free Tetrahedral**.
 - 2 In the **Settings** window for **Free Tetrahedral**, click  **Build All**.
- Compare the mesh with the figure shown below.

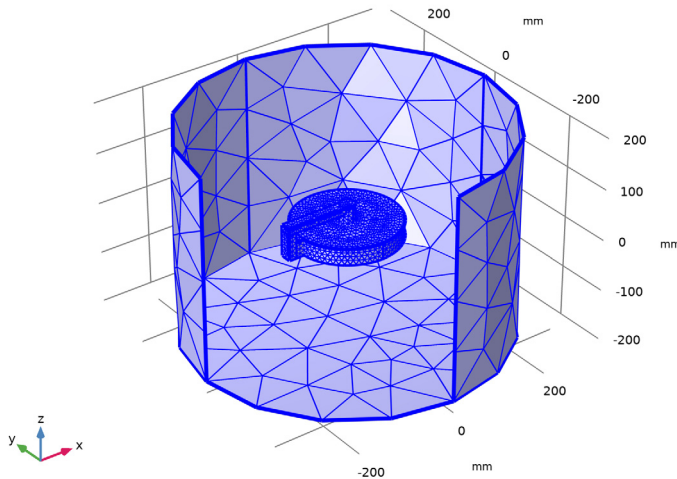

STUDY I

- 1 In the **Model Builder** window, click **Study I**.
- 2 In the **Settings** window for **Study**, locate the **Study Settings** section.

3 Clear the **Generate default plots** check box.

4 In the **Home** toolbar, click  **Compute**.

RESULTS

In the **Model Builder** window, expand the **Results** node.

Study 1/Solution 1 (sol1)

Create a dataset for visualizing the results in the copper domain only.

Study 1/Solution 1 (2) (sol1)

1 In the **Model Builder** window, expand the **Results>Datasets** node.

2 Right-click **Results>Datasets>Study 1/Solution 1 (sol1)** and choose **Duplicate**.

Selection

1 In the **Results** toolbar, click  **Attributes** and choose **Selection**.

2 In the **Settings** window for **Selection**, locate the **Geometric Entity Selection** section.

3 From the **Geometric entity level** list, choose **Domain**.

4 From the **Selection** list, choose **Copper Domains**.

Use the following instructions to reproduce the plot for the current density shown in [Figure 2](#).

3D Plot Group 1

1 In the **Results** toolbar, click  **3D Plot Group**.

2 In the **Settings** window for **3D Plot Group**, locate the **Data** section.

3 From the **Dataset** list, choose **Study 1/Solution 1 (2) (sol1)**.

Streamline 1

1 Right-click **3D Plot Group 1** and choose **Streamline**.

2 In the **Settings** window for **Streamline**, click **Replace Expression** in the upper-right corner of the **Expression** section. From the menu, choose **Component 1 (comp1)>Magnetic and Electric Fields>Currents and charge>mef.jx,mef.jy,mef.jz - Current density**.

3 Locate the **Streamline Positioning** section. In the **Number** text field, type 50.

4 Locate the **Selection** section. Click  **Paste Selection**.

5 In the **Paste Selection** dialog box, type 34 in the **Selection** text field.

6 Click **OK**.

7 In the **Settings** window for **Streamline**, locate the **Coloring and Style** section.

8 Find the **Line style** subsection. From the **Type** list, choose **Tube**.

9 In the **Tube radius expression** text field, type $\log_{10}(\text{mef}.\text{normJ}) - 5$.

Color Expression 1

- 1 Right-click **Streamline 1** and choose **Color Expression**.
- 2 In the **Settings** window for **Color Expression**, locate the **Expression** section.
- 3 In the **Expression** text field, type $\text{mef}.\text{normJ}$.
- 4 In the **3D Plot Group 1** toolbar, click  **Plot**.

3D Current Plot

- 1 In the **Model Builder** window, under **Results** right-click **3D Plot Group 1** and choose **Rename**.
- 2 In the **Rename 3D Plot Group** dialog box, type 3D Current Plot in the **New label** text field.
- 3 Click **OK**.
- 4 Click the  **Zoom Extents** button in the **Graphics** toolbar.

Next, generate a volume plot for the total magnetic flux density and a streamline plot for the induced magnetic flux density. Compare the plots with [Figure 3](#).

3D Plot Group 2



- 1 In the **Home** toolbar, click  **Add Plot Group** and choose **3D Plot Group**.
- 2 In the **Settings** window for **3D Plot Group**, locate the **Data** section.
- 3 From the **Dataset** list, choose **Study 1/Solution 1 (2) (sol1)**.

Total B

- 1 Right-click **3D Plot Group 2** and choose **Volume**.
- 2 In the **Settings** window for **Volume**, click **Replace Expression** in the upper-right corner of the **Expression** section. From the menu, choose **Component 1 (comp1) > Magnetic and Electric Fields > Magnetic > mef.normB - Magnetic flux density norm - T**.
- 3 Right-click **Volume 1** and choose **Rename**.
- 4 In the **Rename Volume** dialog box, type Total B in the **New label** text field.
- 5 Click **OK**.

Induced B

- 1 In the **Model Builder** window, right-click **3D Plot Group 2** and choose **Streamline**.
- 2 In the **Settings** window for **Streamline**, locate the **Data** section.
- 3 From the **Dataset** list, choose **Study 1/Solution 1 (1) (sol1)**.
- 4 Locate the **Expression** section. In the **z component** text field, type $\text{mef}.\text{Bz} - \text{Bz0}$.

- 5 Locate the **Streamline Positioning** section. In the **Number** text field, type 100.
- 6 Locate the **Selection** section. Click  **Paste Selection**.
- 7 In the **Paste Selection** dialog box, type 24 in the **Selection** text field.
- 8 Click **OK**.
- 9 In the **3D Plot Group 2** toolbar, click  **Plot**.
- 10 Right-click **Streamline 1** and choose **Rename**.
- 11 In the **Rename Streamline** dialog box, type Induced B in the **New label** text field.
- 12 Click **OK**.

Magnetic Flux Density (B)

- 1 In the **Model Builder** window, right-click **3D Plot Group 2** and choose **Rename**.
- 2 In the **Rename 3D Plot Group** dialog box, type Magnetic Flux Density (B) in the **New label** text field.
- 3 Click **OK**.

Reproduce [Figure 4](#) using the following instructions.

3D Plot Group 3

- 1 In the **Home** toolbar, click  **Add Plot Group** and choose **3D Plot Group**.
- 2 In the **Settings** window for **3D Plot Group**, locate the **Data** section.
- 3 From the **Dataset** list, choose **Study 1/Solution 1 (2) (sol1)**.

Arrow Volume 1

- 1 Right-click **3D Plot Group 3** and choose **Arrow Volume**.
- 2 In the **Settings** window for **Arrow Volume**, click **Replace Expression** in the upper-right corner of the **Expression** section. From the menu, choose **Component 1 (comp1)>Magnetic and Electric Fields>Currents and charge>mef.jx,mef.jy,mef.jz - Current density**.
- 3 Locate the **Arrow Positioning** section. Find the **x grid points** subsection. In the **Points** text field, type 40.
- 4 Find the **y grid points** subsection. In the **Points** text field, type 40.
- 5 Find the **z grid points** subsection. From the **Entry method** list, choose **Coordinates**.
- 6 In the **Coordinates** text field, type 0.
- 7 Locate the **Coloring and Style** section. From the **Arrow length** list, choose **Logarithmic**.

Color Expression 1

- 1 Right-click **Arrow Volume 1** and choose **Color Expression**.
- 2 In the **3D Plot Group 3** toolbar, click  **Plot**.

Arrow Volume 2

- 1 In the **Model Builder** window, under **Results>3D Plot Group 3** right-click **Arrow Volume 1** and choose **Duplicate**.
- 2 In the **Settings** window for **Arrow Volume**, click **Replace Expression** in the upper-right corner of the **Expression** section. From the menu, choose **Component 1 (comp1)>Magnetic and Electric Fields>Currents and charge>mef.Jx,mef.Jy,mef.Jz - Current density**.
- 3 Locate the **Arrow Positioning** section. Find the **x grid points** subsection. In the **Points** text field, type 80.
- 4 Find the **y grid points** subsection. In the **Points** text field, type 1.
- 5 Find the **z grid points** subsection. From the **Entry method** list, choose **Number of points**.
- 6 In the **Points** text field, type 20.
- 7 Click to expand the **Inherit Style** section. From the **Plot** list, choose **Arrow Volume 1**.
- 8 In the **3D Plot Group 3** toolbar, click  **Plot**.

Create a volume plot for the resistive loss in the copper domains.

3D Plot Group 4

- 1 In the **Home** toolbar, click  **Add Plot Group** and choose **3D Plot Group**.
- 2 In the **Settings** window for **3D Plot Group**, locate the **Data** section.
- 3 From the **Dataset** list, choose **Study 1/Solution 1 (2) (sol1)**.

Volume 1

- 1 Right-click **3D Plot Group 4** and choose **Volume**.
- 2 In the **Settings** window for **Volume**, click **Replace Expression** in the upper-right corner of the **Expression** section. From the menu, choose **Component 1 (comp1)>Magnetic and Electric Fields>Heating and losses>mef.Qh - Volumetric loss density, electromagnetic - W/m³**.
- 3 Locate the **Coloring and Style** section. From the **Color table** list, choose **GrayBody**.
- 4 In the **3D Plot Group 4** toolbar, click  **Plot**.

Compare this figure with that shown in [Figure 5](#).

Finally, evaluate the total current through the conductor as the surface integral of the current density norm.

Surface Integration 1

- 1 In the **Results** toolbar, click  **More Derived Values** and choose **Integration>Surface Integration**.
- 2 Select Boundary 27 only.

- 3 In the **Settings** window for **Surface Integration**, click **Replace Expression** in the upper-right corner of the **Expressions** section. From the menu, choose **Component 1 (comp1)>Magnetic and Electric Fields>Currents and charge>mef.normj - Current density norm - A/m²**.
- 4 Click  **Evaluate**.

TABLE

- 1 Go to the **Table** window.

The total current through the conductor should be about 45 kA.