

Transient Modeling of a Capacitor in a Circuit

Introduction

This example solves a transient model of a capacitor in combination with an external electrical circuit. The finite element model of the capacitor is combined with a circuit model of a voltage source and a resistor. A step change in voltage is applied, and the transient current through the capacitor is computed and compared to the analytic result.

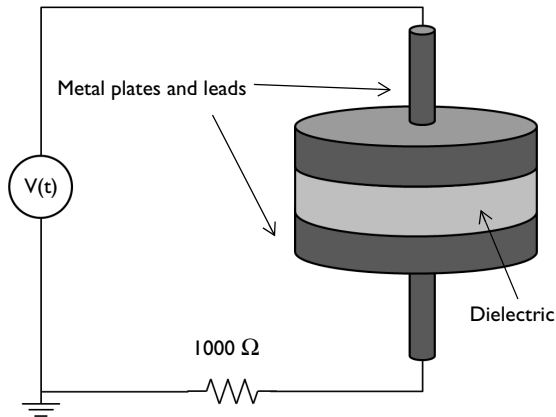

Figure 1: A simple capacitor composed of a disk of dielectric with metal plates on either side and lead wires is connected to a circuit model of a voltage source and a resistor.

Model Definition

The modeled capacitor consists of two metal disks with leads separated by a disk of quartz glass with a relative permittivity $\epsilon_r = 4.2$ and a small electric conductivity $\sigma = 10^{-14}$ S/m (Figure 1). The model includes a region of surrounding air ($\epsilon_r = 1.0$, $\sigma = 5 \cdot 10^{-15}$ S/m) to account for the fringing fields. The capacitor is connected to an external circuit composed of a voltage source and a resistor. Initially, the capacitor is in an equipotential state, with no potential difference between the plates. The voltage across the system is turned on instantaneously, and the potential fields and current through the device are computed.

Assume that the capacitor plates themselves are highly conductive, so that their total effective resistivity is much lower than that of the external resistor. Under this assumption, the electric potential in each of the plates is uniform at any instant in time.

A separate electrostatic analysis can be used to compute the capacitance of the device with the result $C = 43.4$ pF. The external resistor has a resistance of $R = 1000$ Ω . The analytic solution for the current through a resistor and capacitor in series is

$$I(t) = \frac{V_0}{R} \exp\left(\frac{-t}{RC}\right)$$

where V_0 is the applied voltage.

Since the quartz and the air have a low conductivity, displacement currents will be dominant in the beginning of the transient for about 1 μ s. After that, conduction currents will become significant and the model will start to deviate from the analytic approximation. Because both displacement and conduction currents exist in this model, use the Electric Currents interface.

When solving a finite element model and a circuit model in combination, it is sometimes necessary to adjust the solver settings. Here, you solve the electric currents problem and the electric circuits problem using a coupled direct solver. This is the most robust solver combination, but also the most memory intensive one.

Results and Discussion

[Figure 2](#) compares the model result for the current through the capacitor as a function of time for a unit change in the applied voltage with the analytic solution. As the figure shows, the agreement is very good.

The displacement and conduction current densities at a point midway between the capacitor plates are plotted in [Figure 3](#). While the displacement current density drops off to zero, the induced conduction current density rises in time to a steady-state value. At first, the magnitude of the displacement current density is much higher than the magnitude of the conduction current density, which means that the device has only small leakage currents and losses at these time scales.

Finally, [Figure 4](#) compares the model to the analytical approximation on a longer time scale. The analytical approximation can be improved by adding a lumped resistor, parallel to the capacitor, representing the nonzero conductivity of the insulators.

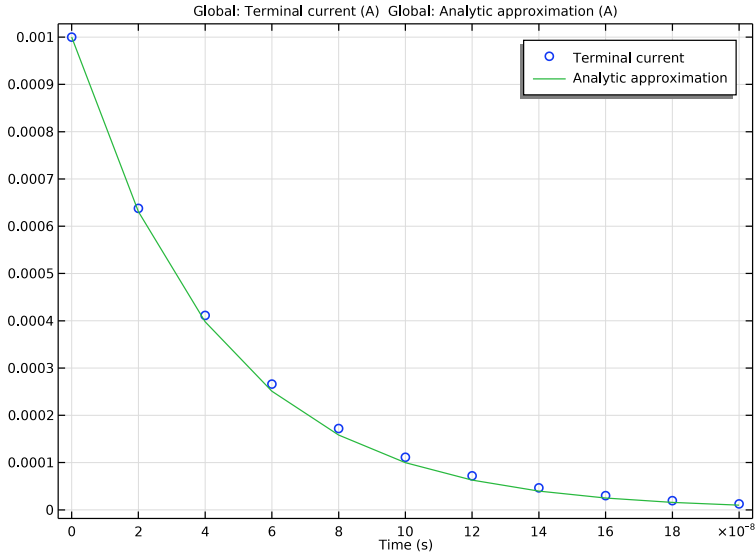

Figure 2: The current through the capacitor after a change in voltage is applied across the system.

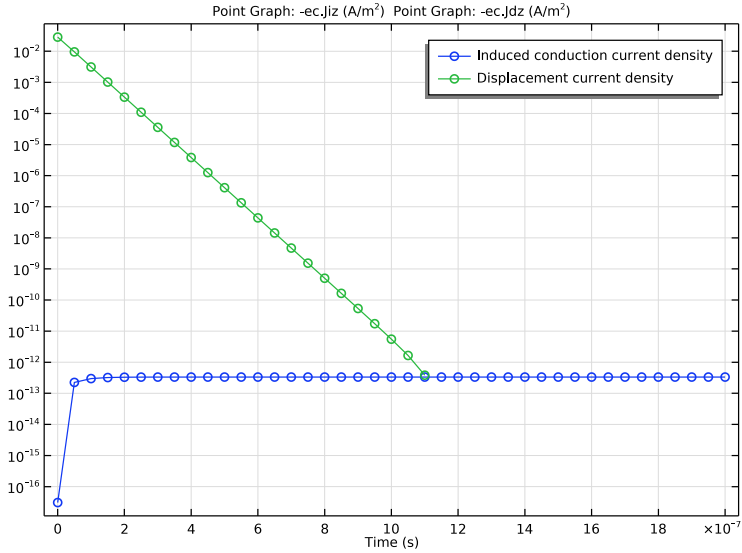

Figure 3: The induced conduction and displacement current densities in the quartz dielectric.

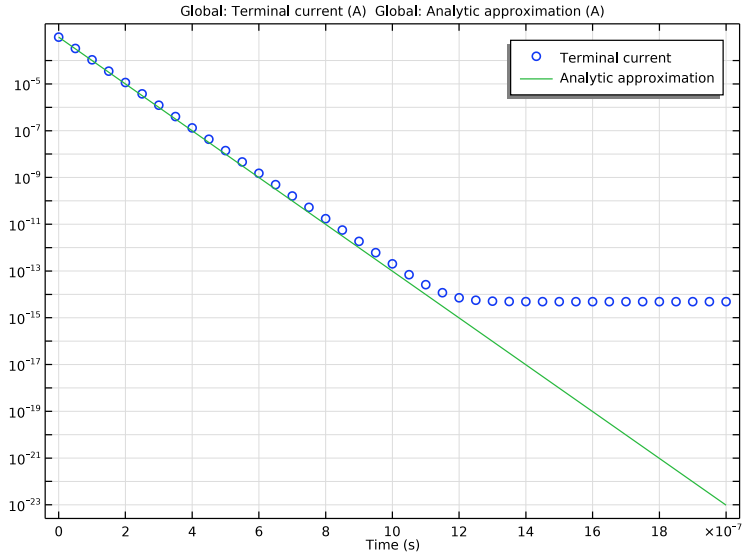



Figure 4: The current through the capacitor. After about $1 \mu\text{s}$ the model starts to deviate from the analytic solution.

Application Library path: ACDC_Module/Capacitive_Devices/
capacitor_transient

Modeling Instructions



From the **File** menu, choose **New**.

NEW

In the **New** window, click  **Model Wizard**.

MODEL WIZARD

- 1 In the **Model Wizard** window, click  **3D**.
- 2 In the **Select Physics** tree, select **AC/DC>Electric Fields and Currents>Electric Currents (ec)**.
- 3 Click **Add**.
- 4 In the **Select Physics** tree, select **AC/DC>Electrical Circuit (cir)**.

- 5 Click **Add**.
- 6 Click  **Study**.
- 7 In the **Select Study** tree, select **General Studies>Time Dependent**.
- 8 Click  **Done**.

GLOBAL DEFINITIONS

Parameters 1

- 1 In the **Model Builder** window, under **Global Definitions** click **Parameters 1**.
- 2 In the **Settings** window for **Parameters**, locate the **Parameters** section.
- 3 In the table, enter the following settings:



Name	Expression	Value	Description
R	1000[ohm]	1000 Ω	External resistor resistance
C	43.4[pF]	4.34E-11 F	Device capacitance
V0	1[V]	1 V	Applied voltage

GEOMETRY 1

- 1 In the **Model Builder** window, under **Component 1 (comp1)** click **Geometry 1**.
- 2 In the **Settings** window for **Geometry**, locate the **Units** section.
- 3 From the **Length unit** list, choose **cm**.

First, create a cylinder for the model domain.

Cylinder 1 (cyl1)

- 1 In the **Geometry** toolbar, click  **Cylinder**.
- 2 In the **Settings** window for **Cylinder**, locate the **Size and Shape** section.
- 3 In the **Radius** text field, type 20.
- 4 In the **Height** text field, type 20.
- 5 Click  **Build Selected**.

Choose wireframe rendering to get a better view of the interior parts.

- 6 Click the  **Wireframe Rendering** button in the **Graphics** toolbar.

Then, add a cylinder for the disc of dielectric with the two metal plates.

Cylinder 2 (cyl2)

- 1 In the **Geometry** toolbar, click  **Cylinder**.

- 2 In the **Settings** window for **Cylinder**, locate the **Size and Shape** section.
- 3 In the **Radius** text field, type 10.
- 4 In the **Height** text field, type 4.
- 5 Locate the **Position** section. In the **z** text field, type 8.
- 6 Click to expand the **Layers** section. In the table, enter the following settings:

Layer name	Thickness (cm)
Layer 1	5 [mm]

- 7 Clear the **Layers on side** check box.
- 8 Select the **Layers on bottom** check box.
- 9 Select the **Layers on top** check box.
- 10 Click  **Build Selected**.

Finish the geometry by adding two cylinders for the leads.

Cylinder 3 (cyl3)

- 1 In the **Geometry** toolbar, click  **Cylinder**.
- 2 In the **Settings** window for **Cylinder**, locate the **Size and Shape** section.
- 3 In the **Radius** text field, type 0.75.
- 4 In the **Height** text field, type 8.

Cylinder 4 (cyl4)

- 1 Right-click **Cylinder 3 (cyl3)** and choose **Duplicate**.
- 2 In the **Settings** window for **Cylinder**, locate the **Position** section.
- 3 In the **z** text field, type 12.

4 Click  **Build All Objects**.

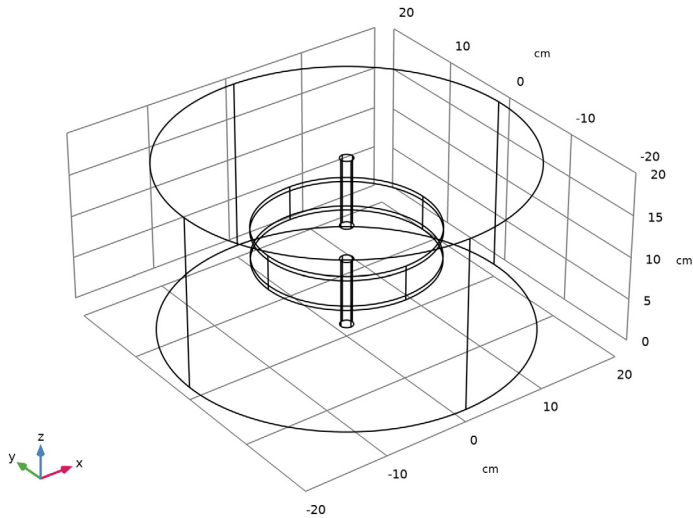

The result should look like the image above.

ELECTRIC CURRENTS (EC)

The model is composed of a disc of dielectric material with metal plates on either side and two lead wires. To get a better view, hide some of the boundaries. Begin by selecting the **Electric Currents** interface, then add a **Hide** node.

DEFINITIONS

Hide for Physics I

- 1 In the **Model Builder** window, expand the **Component 1 (comp1)>Definitions** node.
- 2 Right-click **View 1** and choose **Hide for Physics**.
- 3 In the **Settings** window for **Hide for Physics**, locate the **Geometric Entity Selection** section.
- 4 From the **Geometric entity level** list, choose **Boundary**.

5 Select Boundaries 1, 4, and 23 only.

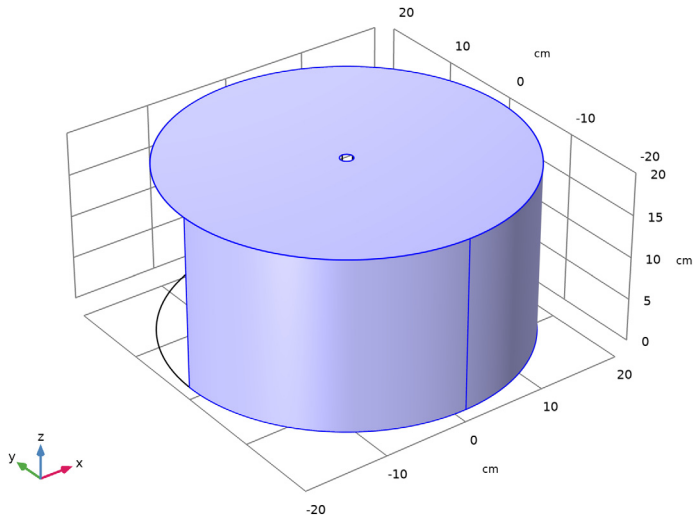

Add a couple of terminals to the **Electric Currents** interface and connect them to the circuit and ground.

ELECTRIC CURRENTS (EC)

Terminal 1

- 1 In the **Model Builder** window, under **Component 1 (comp1)** right-click **Electric Currents (ec)** and choose the domain setting **Terminal**.
- 2 Select Domains 4 and 6 only.
- 3 In the **Settings** window for **Terminal**, locate the **Terminal** section.
- 4 From the **Terminal type** list, choose **Circuit**.

A ground boundary condition is applied to all surfaces surrounding the lower electrode. Simultaneously the domains are deselected from the physics. For such models, this is the suggested setup.

DEFINITIONS

Explicit 1

- 1 In the **Definitions** toolbar, click  **Explicit**.
- 2 Select Domains 2 and 5 only.

- 3 In the **Settings** window for **Explicit**, locate the **Output Entities** section.
- 4 From the **Output entities** list, choose **Adjacent boundaries**.

ELECTRIC CURRENTS (EC)

Ground I

- 1 In the **Physics** toolbar, click  **Boundaries** and choose **Ground**.
- 2 In the **Settings** window for **Ground**, locate the **Boundary Selection** section.
- 3 From the **Selection** list, choose **Explicit 1**.
- 4 In the **Model Builder** window, click **Electric Currents (ec)**.
- 5 Select Domains 1, 3, 4, and 6 only.

Create a lumped **Resistor** and a **Voltage Source**, and put them in series with the capacitor model.

ELECTRICAL CIRCUIT (CIR)

In the **Model Builder** window, under **Component 1 (comp1)** click **Electrical Circuit (cir)**.

Resistor 1 (R1)

- 1 In the **Electrical Circuit** toolbar, click  **Resistor**.
- 2 In the **Settings** window for **Resistor**, locate the **Node Connections** section.
- 3 In the table, enter the following settings:

Label	Node names
p	1
n	0

Voltage Source 1 (V1)

- 1 In the **Electrical Circuit** toolbar, click  **Voltage Source**.
- 2 In the **Settings** window for **Voltage Source**, locate the **Node Connections** section.
- 3 In the table, enter the following settings:

Label	Node names
p	2
n	0

External I vs. U I (IvsUI)

- 1 In the **Electrical Circuit** toolbar, click  **External I vs. U**.

- 2 In the **Settings** window for **External I vs. U**, locate the **Node Connections** section.
- 3 In the table, enter the following settings:

Label	Node names
p	2
n	1

- 4 Locate the **External Device** section. From the *V* list, choose **Terminal voltage (ec/term I)**.

Next, assign material properties to the model. Begin by specifying **Air** for all domains. Adjust its conductivity to $5e-15$ [S/m].

ADD MATERIAL

- 1 In the **Home** toolbar, click  **Add Material** to open the **Add Material** window.
- 2 Go to the **Add Material** window.
- 3 In the tree, select **Built-in>Air**.
- 4 Click **Add to Component** in the window toolbar.

MATERIALS

Air (mat1)

- 1 In the **Settings** window for **Material**, locate the **Material Contents** section.
- 2 In the table, enter the following settings:

Property	Variable	Value	Unit	Property group
Relative permittivity	epsilonIso ; epsilonRii = epsilonIso, epsilonRij = 0	1		Basic
Electrical conductivity	sigmaIso ; sigmaIii = sigmaIso, sigmaIij = 0	5e - 15 [S/m]	S/m	Basic

Override the dielectric disc with glass (quartz).

ADD MATERIAL

- 1 Go to the **Add Material** window.
- 2 In the tree, select **Built-in>Glass (quartz)**.

3 Click **Add to Component** in the window toolbar.

4 In the **Home** toolbar, click  **Add Material** to close the **Add Material** window.

MATERIALS

Glass (quartz) (mat2)

Select Domain 3 only.

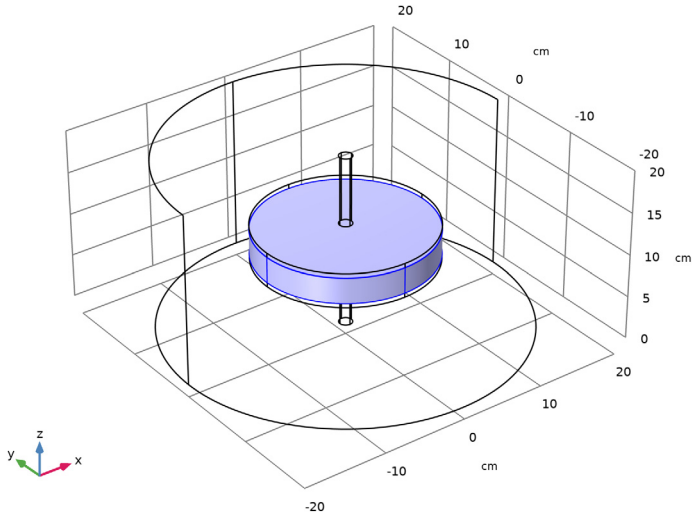

MESH I

In the **Model Builder** window, under **Component I (comp1)** right-click **Mesh I** and choose **Build All**.

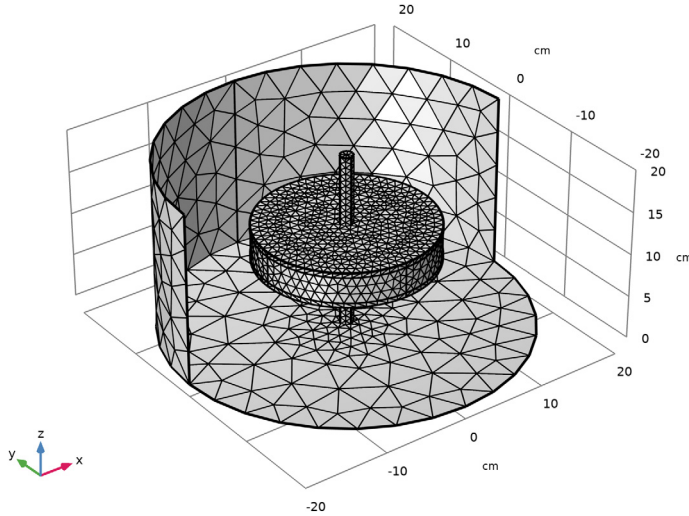

STUDY I



- 1 In the **Model Builder** window, click **Study I**.
- 2 In the **Settings** window for **Study**, locate the **Study Settings** section.
- 3 Clear the **Generate default plots** check box.

Step 1: Time Dependent

- 1 In the **Model Builder** window, under **Study I** click **Step 1: Time Dependent**.
- 2 In the **Settings** window for **Time Dependent**, locate the **Study Settings** section.
- 3 Click  **Range**.
- 4 In the **Range** dialog box, type $2e-8$ in the **Step** text field.
- 5 In the **Stop** text field, type $2e-7$.
- 6 Click **Replace**.

For maximal robustness, apply a direct solver, and **Exclude Algebraic** from error estimate. This is suggested for many time dependent problems. As this option may be relaxing some of the decisions of the time dependent stepping algorithm, a maximum time step is added, and maximum BDF order is decreased. This preserves accuracy of variables even when currents are nearly zero.

Solution 1 (sol1)

- 1 In the **Study** toolbar, click  **Show Default Solver**.
- 2 In the **Model Builder** window, expand the **Solution 1 (sol1)** node.
- 3 Right-click **Study 1>Solver Configurations>Solution 1 (sol1)>Time-Dependent Solver 1** and choose **Fully Coupled**.
- 4 Right-click **Study 1>Solver Configurations>Solution 1 (sol1)>Time-Dependent Solver 1 >Direct** and choose **Enable**.
- 5 In the **Model Builder** window, under **Study 1>Solver Configurations>Solution 1 (sol1)** click **Time-Dependent Solver 1**.
- 6 In the **Settings** window for **Time-Dependent Solver**, click to expand the **Time Stepping** section.
- 7 Find the **Algebraic variable settings** subsection. From the **Error estimation** list, choose **Exclude algebraic**.
- 8 From the **Maximum BDF order** list, choose **1**.
- 9 From the **Maximum step constraint** list, choose **Constant**.
- 10 In the **Maximum step** text field, type $5e-9$.
- 11 In the **Study** toolbar, click  **Compute**.
- 12 In the **Results** toolbar, click  **Cut Point 3D**.

RESULTS

Cut Point 3D 1

- 1 In the **Settings** window for **Cut Point 3D**, locate the **Point Data** section.
- 2 In the **x** text field, type 0.
- 3 In the **y** text field, type 0.
- 4 In the **z** text field, type 10.

3D Plot Group 1

In the **Results** toolbar, click  **3D Plot Group**.

Slice 1

- 1 Right-click **3D Plot Group 1** and choose **Slice**.
- 2 In the **Settings** window for **Slice**, locate the **Plane Data** section.
- 3 In the **Planes** text field, type 1.
- 4 In the **3D Plot Group 1** toolbar, click  **Plot**.

The electric potential should be constant in the metallic domains. To better visualize the electric potential profile in the air, exclude those domains from the dataset.

Study 1/Solution 1 (sol1)

In the **Model Builder** window, under **Results>Datasets** click **Study 1/Solution 1 (sol1)**.

Selection

- 1 In the **Results** toolbar, click  **Attributes** and choose **Selection**.
- 2 In the **Settings** window for **Selection**, locate the **Geometric Entity Selection** section.
- 3 From the **Geometric entity level** list, choose **Domain**.
- 4 Select Domains 1 and 3 only.

3D Plot Group 1

- 1 In the **Model Builder** window, under **Results** click **3D Plot Group 1**.
- 2 In the **3D Plot Group 1** toolbar, click  **Plot**.

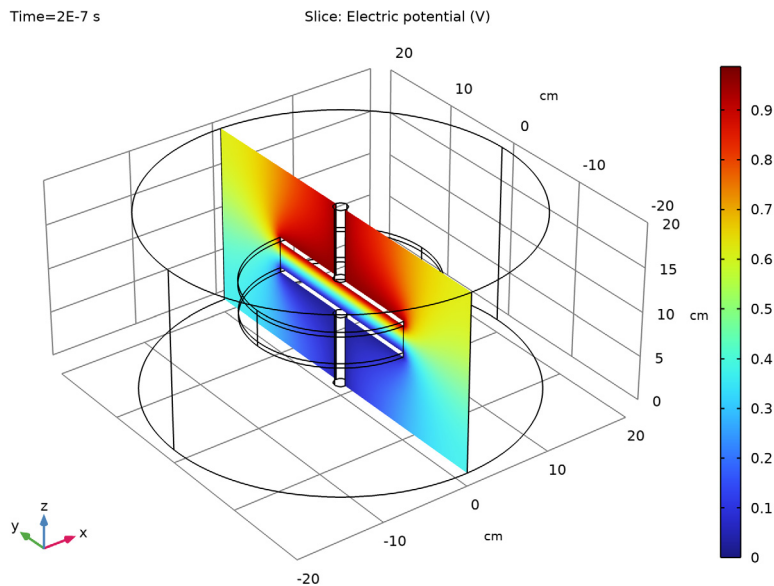

1D Plot Group 2

In the **Home** toolbar, click  **Add Plot Group** and choose **1D Plot Group**.

Global 1

- 1 Right-click **1D Plot Group 2** and choose **Global**.

- 2 In the **Settings** window for **Global**, click **Replace Expression** in the upper-right corner of the **y-Axis Data** section. From the menu, choose **Component 1 (comp1)>Electric Currents>Terminals>ec.I0_1 - Terminal current - A**.
- 3 Click to expand the **Coloring and Style** section. Find the **Line style** subsection. From the **Line** list, choose **None**.
- 4 Find the **Line markers** subsection. From the **Marker** list, choose **Circle**.
- 5 From the **Positioning** list, choose **In data points**.

Global 2

- 1 In the **Model Builder** window, right-click **ID Plot Group 2** and choose **Global**.
- 2 In the **Settings** window for **Global**, locate the **y-Axis Data** section.
- 3 In the table, enter the following settings:

Expression	Unit	Description
$(V0/R)*\exp(-t/(R*C))$	A	Analytic approximation

- 4 In the **ID Plot Group 2** toolbar, click  **Plot**.
Compare the resulting plot with [Figure 2](#). The model and the analytic approximation show good correspondence.

ID Plot Group 3

- 1 In the **Home** toolbar, click  **Add Plot Group** and choose **ID Plot Group**.
- 2 In the **Settings** window for **ID Plot Group**, locate the **Data** section.
- 3 From the **Dataset** list, choose **Cut Point 3D I**.

Point Graph 1

- 1 Right-click **ID Plot Group 3** and choose **Point Graph**.
- 2 In the **Settings** window for **Point Graph**, locate the **y-Axis Data** section.
- 3 In the **Expression** text field, type `-ec.Jiz`.
- 4 Click to expand the **Coloring and Style** section. Find the **Line markers** subsection. From the **Marker** list, choose **Circle**.
- 5 From the **Positioning** list, choose **In data points**.
- 6 Click to expand the **Legends** section. Select the **Show legends** check box.
- 7 From the **Legends** list, choose **Manual**.

8 In the table, enter the following settings:

Legends

Induced conduction current density

9 In the **ID Plot Group 3** toolbar, click  **Plot**.

Point Graph 2

1 Right-click **Point Graph 1** and choose **Duplicate**.

2 In the **Settings** window for **Point Graph**, locate the **y-Axis Data** section.

3 In the **Expression** text field, type `-ec.Jdz`.

4 Locate the **Legends** section. In the table, enter the following settings:

Legends

Displacement current density

5 In the **ID Plot Group 3** toolbar, click  **Plot**.

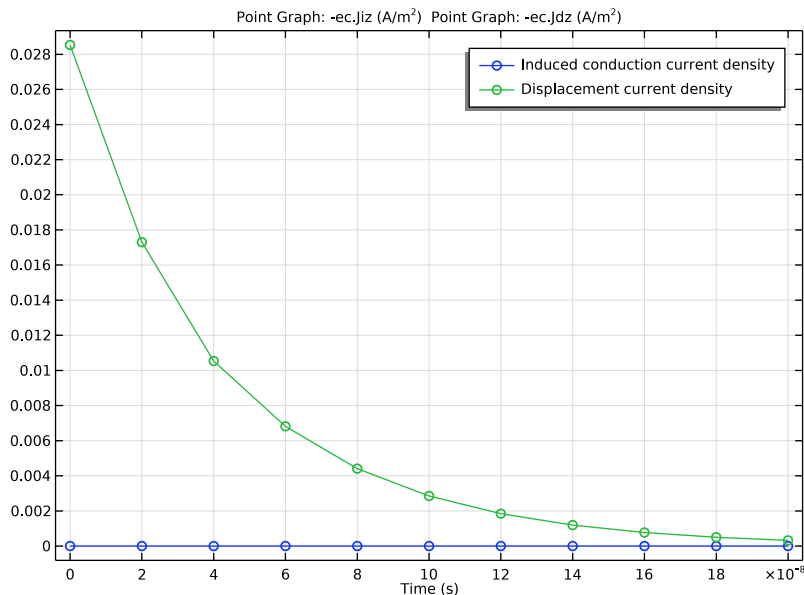

The resulting plot shows a conduction current that is negligible, when compared to the displacement current.

Now, let us see if the analytic approximation still holds on a longer time scale, when the conduction and displacement currents are of the same order.

STUDY 1



Step 1: Time Dependent

- 1 In the **Model Builder** window, under **Study 1** click **Step 1: Time Dependent**.
- 2 In the **Settings** window for **Time Dependent**, locate the **Study Settings** section.
- 3 In the **Output times** text field, type range (0,5e-8,2e-6).
- 4 In the **Home** toolbar, click  **Compute**.

RESULTS

ID Plot Group 3

Switch to log-scale, to better see the currents close to zero.

- 1 Click the  **y-Axis Log Scale** button in the **Graphics** toolbar.
- 2 In the **Model Builder** window, under **Results** click **ID Plot Group 3**.
- 3 In the **ID Plot Group 3** toolbar, click  **Plot**.

The reproduced plot should look like [Figure 3](#). The conduction current starts becoming significant after about one microsecond.

Finish the result analysis by reproducing [Figure 4](#).

ID Plot Group 2

- 1 Click the  **y-Axis Log Scale** button in the **Graphics** toolbar.
- 2 In the **Model Builder** window, click **ID Plot Group 2**.

3 In the **ID Plot Group 2** toolbar, click  **Plot**.

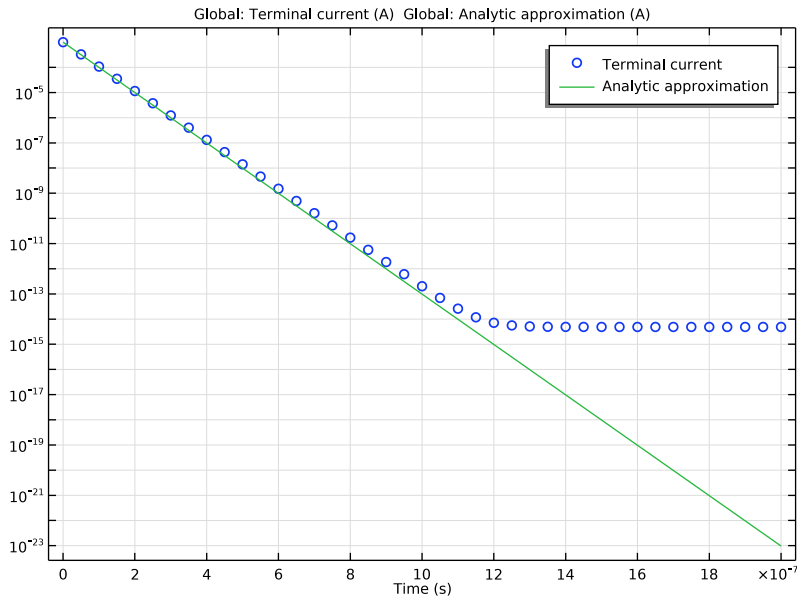

The analytic approximation starts to fail as soon as the conduction currents through the air and the quartz become significant.

