



Single Mode Fiber-to-Fiber Coupling

Introduction

Optical fibers can be used to efficiently transmit optical signals over large distances with minimal losses. Among the wide variety of fibers that exist, one important categorization criterion is if the fiber is multimode or single mode. In a single mode fiber, only one spatial mode can exist. Radiation profiles that don't match that mode's profile will not be bound to the core and, thus, have high losses. As the name already suggests, a multimode fiber, on the other hand, can support a set of spatial modes that can be transmitted almost without loss. For step index fibers, if the fiber or waveguide parameter

$$V = \frac{2\pi}{\lambda} a \sqrt{n_{\text{core}}^2 - n_{\text{clad}}^2}$$

is below 2.405 only one spatial mode is supported. Here, n is the refractive index, a is the radius of the fiber core, and λ is the vacuum wavelength.

A common way to couple light into an optical fiber is to start with a free space beam and use a lens to focus the light onto the fiber end. When a light field enters a fiber, it is decomposed into the set of modes that can exist in the fiber. As the fibers are mode-selective, we have to make sure that the mode impinging onto the fiber tip will be coupled in to the fiber. In the case of a single mode fiber, where only one spatial mode is guided, the input beam has to match this one specific mode of the fiber. The field emitted by the fiber is the proper input field on the fiber. Field components in other spatial modes will be lost in the cladding as they are not guided.

Model Definition

This model uses the *Electromagnetic Waves, Beam Envelopes* interface in the unidirectional formulation to model the free space fiber-to-fiber coupling with two identical lenses. The first lens collimates the light emitted by the fiber, while the second lens focuses the collimated light onto the second fiber tip. The unidirectional formulation is a good choice, as all surfaces in this model use single layer anti-reflective coatings to suppress reflections. The geometry is surrounded by *Perfectly Matched Layers* to absorb any outgoing waves.

The anti-reflection (AR) coatings between air with $n = 1$ and a material with refractive index n_{mat} are defined using a *Transition Boundary Condition* that models a thin layer with refractive index $n_{AR} = \sqrt{n_{\text{mat}}}$ and thickness $d_{AR} = \lambda / (4n_{AR})$.

At the fiber tips, the computed effective mode index `ewbe.neff_1` is used when calculating the refractive index of the AR coating. As both fibers are identical, `ewbe.neff_1 = ewbe.neff_2`.

To reduce the necessary number of mesh elements along the optical axis and make efficient use of the beam envelopes method, proper choice of the phase function is crucial. Here, the different domains are assigned local phase functions. In the fibers, the propagation constant `ewbe.beta_1` is solved for in a *Boundary Mode Analysis* study step. Thus, here the phase is defined as `ewbe.beta_1*x`. In the air domain and the lenses, the local free-space propagation constant `ewbe.k` is used. For these domains, the phase is defined as `ewbe.k*x`. Normally, the phase function should be continuous everywhere. However, the *Transition Boundary Condition* allows the user-defined phase function to be discontinuous and, thus, different local phase functions can be used, as described above.

The key metric we want to analyze in this model is the fiber-to-fiber coupling efficiency. How much of the light that is guided in the first fiber will be coupled into the (identical) mode of the second fiber? To compute this value, we use two *Ports* of the *Numeric* type in the model. The *Boundary Mode Analysis* study steps, compute the eigenmodes and propagation constants of the fibers. The final Frequency Domain study step, solves for the electric field in the domains and the S-parameters. The port on the right-hand side is a *Slit Port*, which allows it to be defined on an internal boundary, backed by a *Perfectly Matched Layer (PML)*. Here, the S-parameter is calculated as the overlap of the input field and the fiber mode. The *PML-backed Slit Port* makes sure that all outgoing radiation is absorbed. If a *Slit Port* would not be used, only the fiber (*Port*) mode would be absorbed and reflections would occur for all field components that are not matching the particular fiber (*Port*) mode.

To find the proper lens position, the second lens is moved with a *Parametric Sweep* and the total transmission is analyzed.

Results and Discussion

Figure 1 shows that the coupling loss is minimized when the lenses are moved $4\ \mu\text{m}$ closer to the fiber ends than the nominal focal length of the lens.

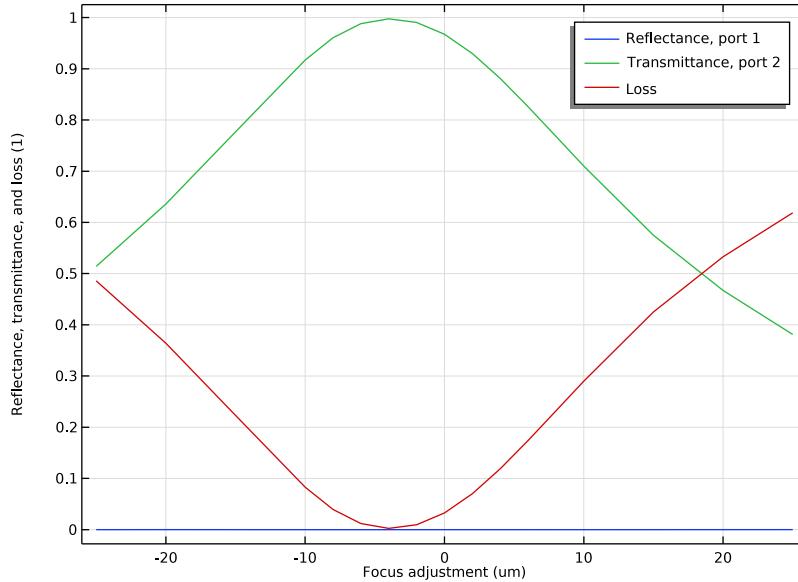

Figure 1: The plot shows the reflectance (blue), transmittance (green), and loss (red) for the fiber-to-fiber coupling system. As shown, the loss is minimized when the lenses are moved $4\ \mu\text{m}$ closer to the fiber end than the nominal focal length.

Figure 2 shows a field plot for the case when the lenses are located in the position for minimum coupling loss. It is clear from both Figure 1 and Figure 2 that the anti-reflection coatings, modeled using the Transition boundary condition, eliminate the reflections at

the fiber ends and at the lens surfaces. Thus, justifying the use of the unidirectional formulation.

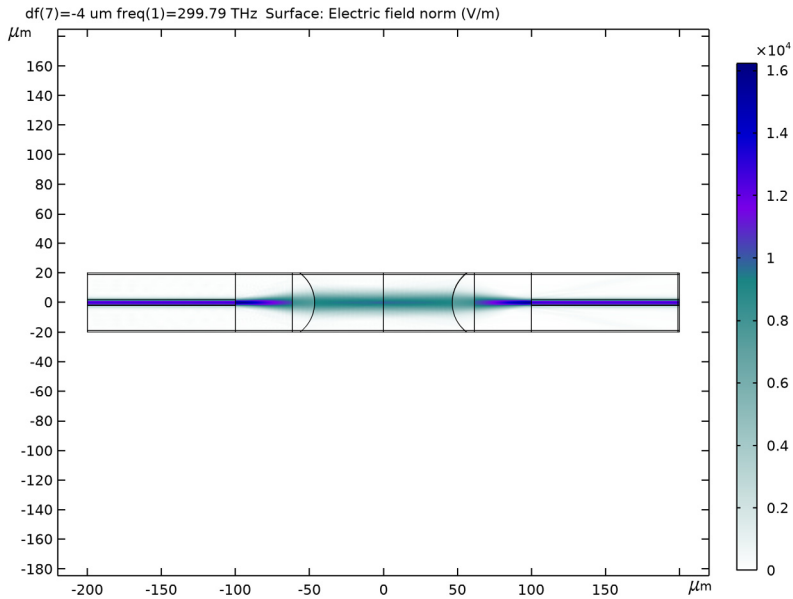



Figure 2: The norm of the electric field, when the lenses are in the position for minimum losses.

Application Library path: Wave_Optics_Module/Waveguides_and_Couplers/
single_mode_fiber_coupling

Modeling Instructions

From the **File** menu, choose **New**.

NEW

In the **New** window, click  **Model Wizard**.

MODEL WIZARD

- 1 In the **Model Wizard** window, click  **2D**.
- 2 In the **Select Physics** tree, select **Optics>Wave Optics>Electromagnetic Waves, Beam Envelopes (ewbe)**.

- 3 Click **Add**.
- 4 Click  **Study**.
- 5 In the **Select Study** tree, select **Preset Studies for Selected Physics Interfaces > Boundary Mode Analysis**.
- 6 Click  **Done**.

GLOBAL DEFINITIONS

Parameters 1

- 1 In the **Model Builder** window, under **Global Definitions** click **Parameters 1**.
- 2 In the **Settings** window for **Parameters**, locate the **Parameters** section.
- 3 Click  **Load from File**.
- 4 Browse to the model's Application Libraries folder and double-click the file `single_mode_fiber_coupling_parameters.txt`.

GEOMETRY 1

- 1 In the **Model Builder** window, under **Component 1 (comp1)** click **Geometry 1**.
- 2 In the **Settings** window for **Geometry**, locate the **Units** section.
- 3 From the **Length unit** list, choose **μm** .

Rectangle 1 (r1)

- 1 In the **Geometry** toolbar, click  **Rectangle**.
- 2 In the **Settings** window for **Rectangle**, locate the **Size and Shape** section.
- 3 In the **Width** text field, type `1_fiber`.
- 4 In the **Height** text field, type `h_core`.
- 5 Locate the **Position** section. From the **Base** list, choose **Center**.
- 6 In the **x** text field, type `-1_fiber/2-1_dom`.

Rectangle 2 (r2)

- 1 Right-click **Rectangle 1 (r1)** and choose **Duplicate**.
- 2 In the **Settings** window for **Rectangle**, locate the **Size and Shape** section.
- 3 In the **Height** text field, type `h_clad`.
- 4 Click to expand the **Layers** section. In the table, enter the following settings:



Layer name	Thickness (μm)
Layer 1	t_PML

- 5 Select the **Layers on top** check box. The **Layers on bottom** check box is selected by default.

Rectangle 3 (r3)

- 1 In the **Geometry** toolbar, click  **Rectangle**.
- 2 In the **Settings** window for **Rectangle**, locate the **Size and Shape** section.
- 3 In the **Width** text field, type 1_dom .
- 4 In the **Height** text field, type h_clad .
- 5 Locate the **Position** section. In the **x** text field, type -1_dom .
- 6 In the **y** text field, type $-h_clad/2$.
- 7 Locate the **Layers** section. In the table, enter the following settings:

Layer name	Thickness (μm)
Layer 1	t_PML

- 8 Select the **Layers on top** check box.
- 9 Click  **Build Selected**.
- 10 Click the  **Zoom Extents** button in the **Graphics** toolbar.

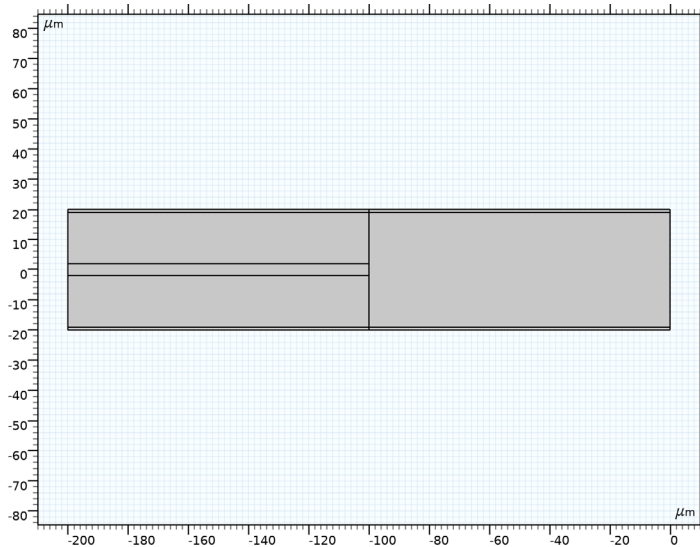



Circle 1 (c1)

- 1 In the **Geometry** toolbar, click  **Circle**.
- 2 In the **Settings** window for **Circle**, locate the **Size and Shape** section.

- 3 In the **Radius** text field, type r_{lens} .
- 4 Locate the **Position** section. In the **x** text field, type r_{lens} .

Rectangle 4 (r4)

- 1 In the **Geometry** toolbar, click  **Rectangle**.
- 2 In the **Settings** window for **Rectangle**, locate the **Size and Shape** section.
- 3 In the **Width** text field, type $t_{\text{lens}} - (r_{\text{lens}} - \sqrt{r_{\text{lens}}^2 - h_{\text{clad}}^2/4})$.
- 4 In the **Height** text field, type h_{clad} .
- 5 Locate the **Position** section. In the **x** text field, type $r_{\text{lens}} - \sqrt{r_{\text{lens}}^2 - h_{\text{clad}}^2/4}$.
- 6 In the **y** text field, type $-h_{\text{clad}}/2$.
- 7 Click  **Build Selected**.
- 8 Click the  **Zoom Extents** button in the **Graphics** toolbar.

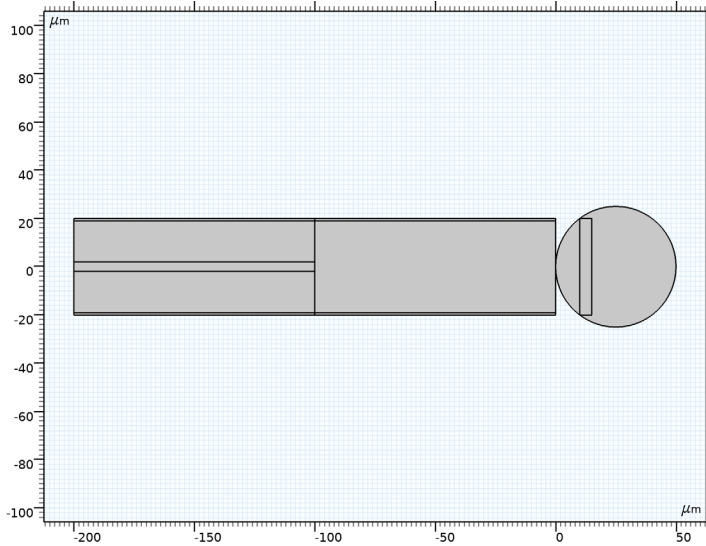

Union 1 (uni1)

- 1 In the **Geometry** toolbar, click  **Booleans and Partitions** and choose **Union**.

2 Select the objects **c1** and **r4** only.

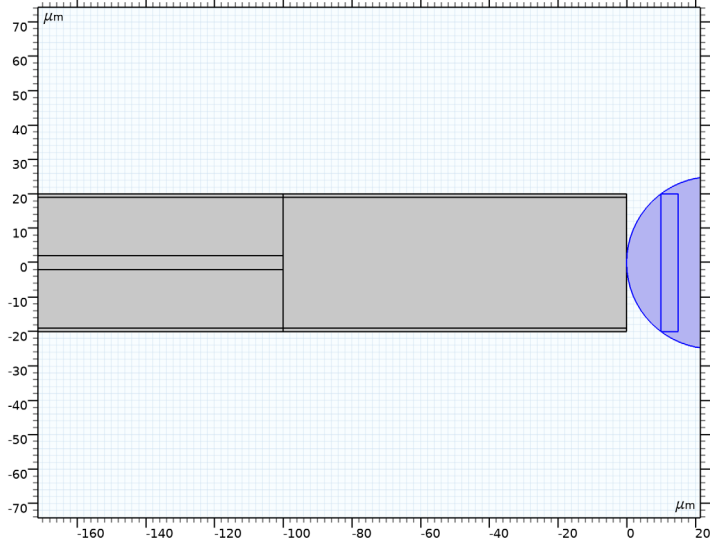

Delete Entities I (del)

- 1 In the **Model Builder** window, right-click **Geometry I** and choose **Delete Entities**.
- 2 In the **Settings** window for **Delete Entities**, locate the **Entities or Objects to Delete** section.
- 3 From the **Geometric entity level** list, choose **Domain**.

4 On the object **uni1**, select Domain 3 only.

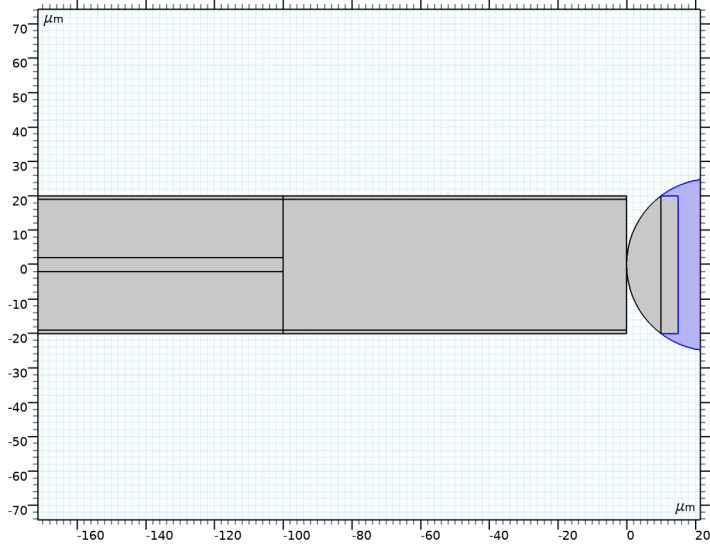

Union 2 (uni2)

- 1 In the **Geometry** toolbar, click  **Booleans and Partitions** and choose **Union**.
- 2 Select the object **dell** only.
- 3 In the **Settings** window for **Union**, locate the **Union** section.
- 4 Clear the **Keep interior boundaries** check box.

Rotate 1 (rot1)

- 1 In the **Geometry** toolbar, click  **Transforms** and choose **Rotate**.
- 2 Select the object **uni2** only.
- 3 In the **Settings** window for **Rotate**, locate the **Rotation** section.
- 4 In the **Angle** text field, type 180.

Move 1 (mov1)

- 1 In the **Geometry** toolbar, click  **Transforms** and choose **Move**.
- 2 Select the object **rot1** only.
- 3 In the **Settings** window for **Move**, locate the **Displacement** section.
- 4 In the **x** text field, type $-t_lens/2+f_lens+df-l_dom+t_lens$.

5 Click  **Build Selected.**

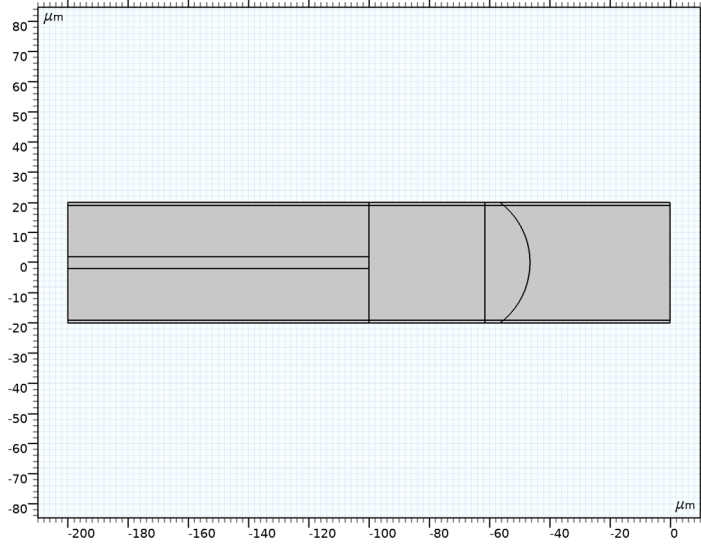

Mirror 1 (mir1)

- 1 In the **Geometry** toolbar, click  **Transforms** and choose **Mirror**.
- 2 Click the  **Select All** button in the **Graphics** toolbar.
- 3 In the **Settings** window for **Mirror**, locate the **Input** section.
- 4 Select the **Keep input objects** check box.
- 5 Click  **Build Selected.**

6 Click the  **Zoom Extents** button in the **Graphics** toolbar.

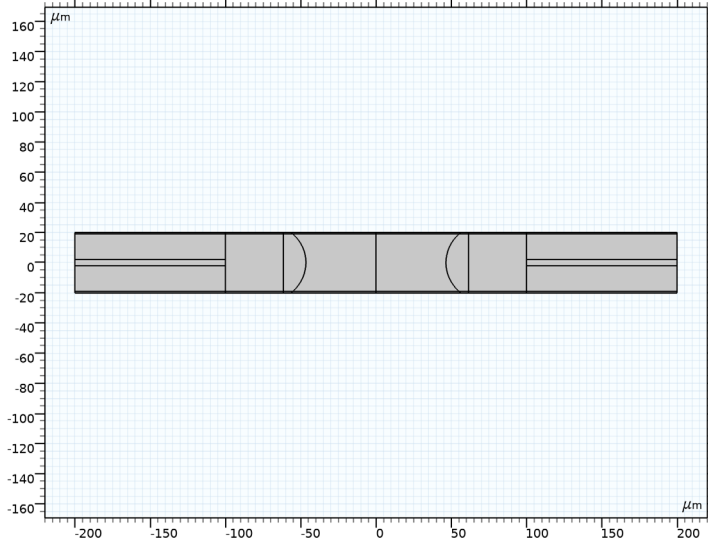

Rectangle 5 (r5)

- 1 In the **Geometry** toolbar, click  **Rectangle**.
- 2 In the **Settings** window for **Rectangle**, locate the **Size and Shape** section.
- 3 In the **Width** text field, type t_{PML} .
- 4 In the **Height** text field, type h_{clad} .
- 5 Locate the **Position** section. In the **x** text field, type $l_{\text{dom}} + l_{\text{fiber}} - t_{\text{PML}}$.
- 6 In the **y** text field, type $-h_{\text{clad}}/2$.

7 Click  **Build All Objects**.

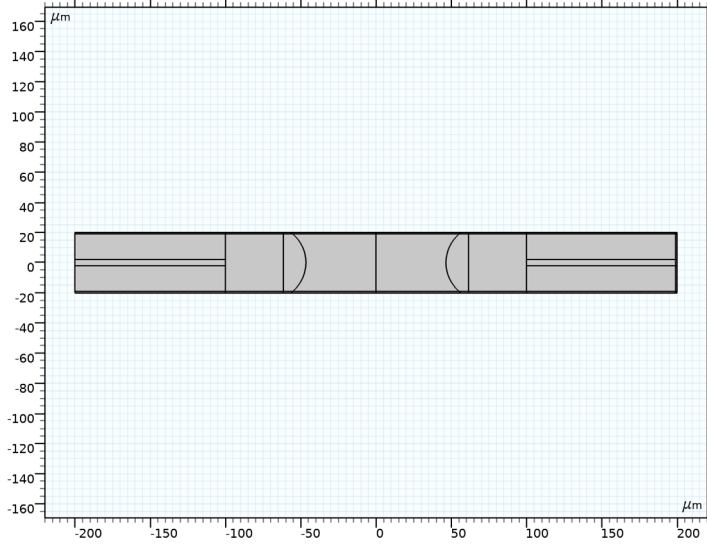

MATERIALS

Air

- 1 In the **Model Builder** window, under **Component 1 (comp1)** right-click **Materials** and choose **Blank Material**.
- 2 In the **Settings** window for **Material**, type Air in the **Label** text field.
- 3 Locate the **Material Contents** section. In the table, enter the following settings:

Property	Variable	Value	Unit	Property group
Refractive index, real part	$n_iso ; n_{ii} = n_iso, n_{ij} = 0$	1	l	Refractive index
Refractive index, imaginary part	$k_i_iso ; k_{iii} = k_i_iso, k_{ij} = 0$	0	l	Refractive index

Lens

- 1 Right-click **Materials** and choose **Blank Material**.
- 2 In the **Settings** window for **Material**, type Lens in the **Label** text field.

3 Select Domains 9–11 and 18–20 only.

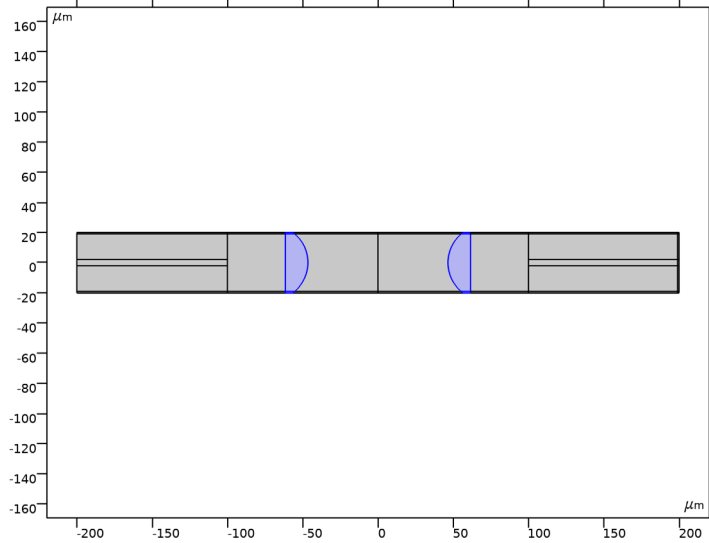

4 Locate the **Material Contents** section. In the table, enter the following settings:

Property	Variable	Value	Unit	Property group
Refractive index, real part	n_{iso} ; $n_{ii} = n_{iso}$, $n_{ij} = 0$	n_{lens}	1	Refractive index
Refractive index, imaginary part	$k_{i_{iso}}$; $k_{iii} =$ $k_{i_{iso}}$, $k_{ij} = 0$	0	1	Refractive index

Core

- 1 Right-click **Materials** and choose **Blank Material**.
- 2 In the **Settings** window for **Material**, type Core in the **Label** text field.

3 Select Domains 3, 26, and 31 only.

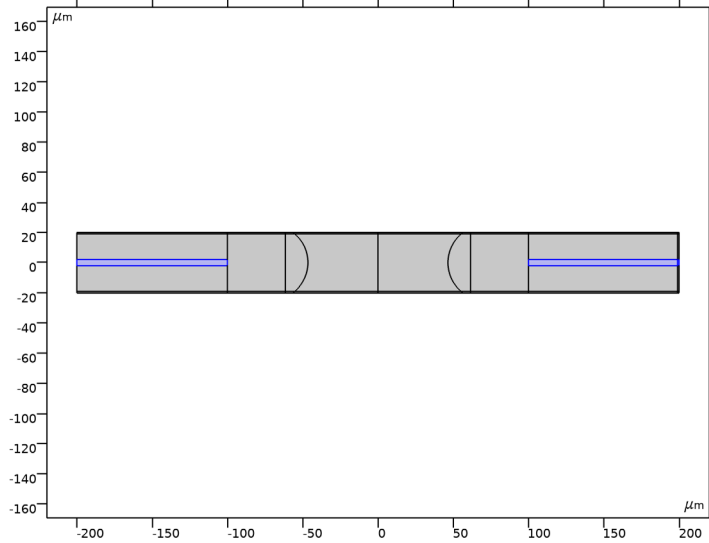

4 Locate the **Material Contents** section. In the table, enter the following settings:

Property	Variable	Value	Unit	Property group
Refractive index, real part	n_{iso} ; $n_{ii} = n_{iso}$, $n_{ij} = 0$	n_{core}	1	Refractive index
Refractive index, imaginary part	k_{i-iso} ; $k_{iii} =$ k_{i-iso} , $k_{ij} = 0$	0	1	Refractive index

Cladding

- 1 Right-click **Materials** and choose **Blank Material**.
- 2 In the **Settings** window for **Material**, type Cladding in the **Label** text field.

3 Select Domains 1, 2, 4, 5, 24, 25, 27–30, 32, and 33 only.

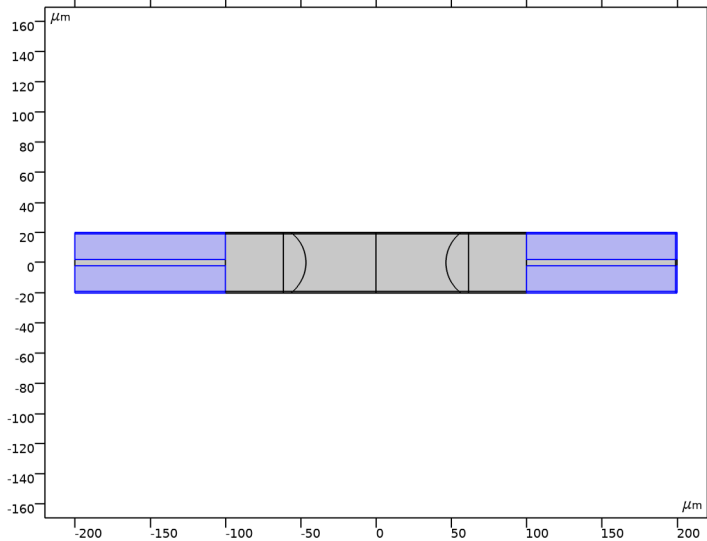

4 Locate the **Material Contents** section. In the table, enter the following settings:

Property	Variable	Value	Unit	Property group
Refractive index, real part	n_{iso} ; $n_{ii} = n_{\text{iso}}$, $n_{ij} = 0$	n_{clad}	l	Refractive index
Refractive index, imaginary part	$k_{i\text{iso}}$; $k_{iii} =$ $k_{i\text{iso}}$, $k_{ij} = 0$	0	l	Refractive index

ELECTROMAGNETIC WAVES, BEAM ENVELOPES (EWBE)

- 1 In the **Model Builder** window, under **Component 1 (comp1)** click **Electromagnetic Waves, Beam Envelopes (ewbe)**.
- 2 In the **Settings** window for **Electromagnetic Waves, Beam Envelopes**, locate the **Components** section.
- 3 From the **Electric field components solved for** list, choose **Out-of-plane vector**.
- 4 Locate the **Wave Vectors** section. From the **Number of directions** list, choose **Unidirectional**.
- 5 From the **Type of phase specification** list, choose **User defined**.
- 6 In the ϕ_1 text field, type psi . This variable will be defined after all physics features have been added.

Port 1

- 1 In the **Physics** toolbar, click  **Boundaries** and choose **Port**.
- 2 Select Boundaries 3, 5, and 7 only.

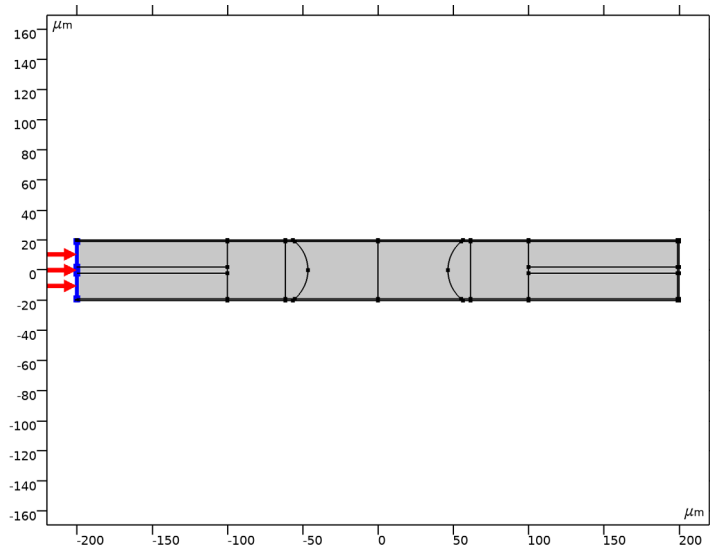

- 3 In the **Settings** window for **Port**, locate the **Port Properties** section.
- 4 From the **Type of port** list, choose **Numeric**.

Port 2

- 1 In the **Physics** toolbar, click  **Boundaries** and choose **Port**.

2 Select Boundaries 63, 65, and 67 only.

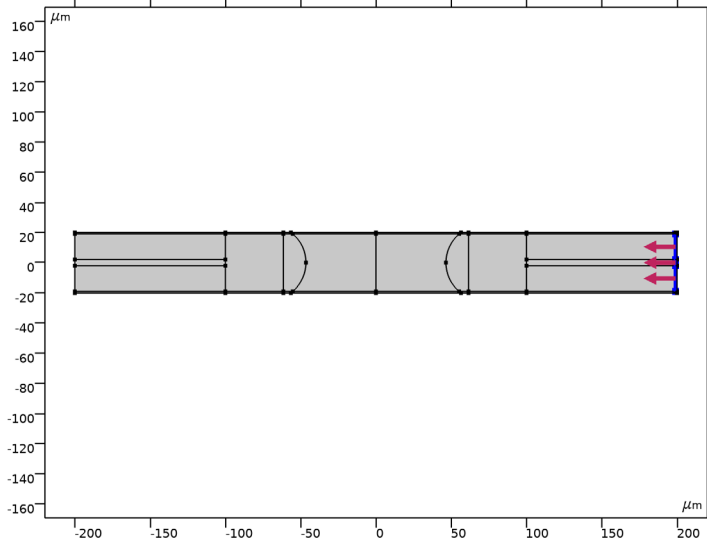

3 In the **Settings** window for **Port**, locate the **Port Properties** section.

4 From the **Type of port** list, choose **Numeric**.

5 Select the **Activate slit condition on interior port** check box.

6 From the **Slit type** list, choose **Domain-backed**.

Transition Boundary Condition 1

Now, add a **Transition boundary condition** feature, to model anti-reflection (AR) coatings on the fiber ends.

1 In the **Physics** toolbar, click  **Boundaries** and choose **Transition Boundary Condition**.

2 Select Boundaries 12, 14, 16–18, 50, 52, 54, 56, and 58 only.

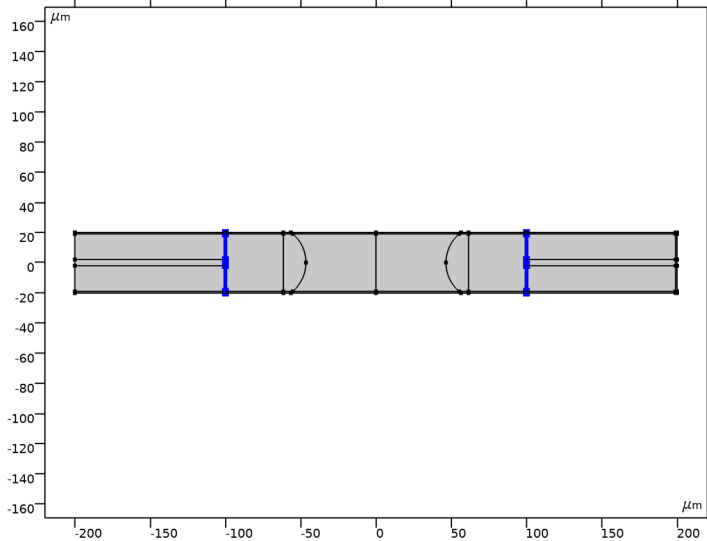

3 In the **Settings** window for **Transition Boundary Condition**, locate the **Transition Boundary Condition** section.

4 From the n list, choose **User defined**. In the associated text field, type $\text{sqrt}(\text{ewbe}.\text{neff}_1)$, to define the refractive index for the AR coating layer.

5 From the k list, choose **User defined**. In the d text field, type $1\text{da}0/4/\text{sqrt}(\text{ewbe}.\text{neff}_1)$, to define the thickness of the AR coating layer.

Transition Boundary Condition 2

Next, add a **Transition boundary condition** feature, to model AR coatings on the lens surfaces.

1 In the **Physics** toolbar, click  **Boundaries** and choose **Transition Boundary Condition**.

2 Select Boundaries 21, 23, 25, 43, 45, 47, and 77–84 only.

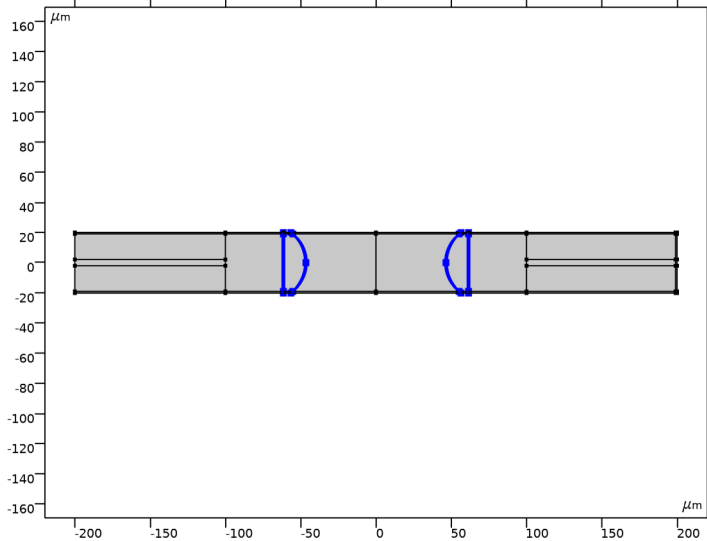

3 In the **Settings** window for **Transition Boundary Condition**, locate the **Transition Boundary Condition** section.

4 From the n list, choose **User defined**. In the associated text field, type $\text{sqrt}(n_lens)$.

5 From the k list, choose **User defined**. In the d text field, type $1d\alpha/4/\text{sqrt}(n_lens)$.

DEFINITIONS

Now, add expressions for the user-defined phase, that is used by the Electromagnetic Waves, Beam Envelopes interface.

Variables 1

1 In the **Model Builder** window, under **Component 1 (comp1)** right-click **Definitions** and choose **Variables**.

2 In the **Settings** window for **Variables**, locate the **Geometric Entity Selection** section.

3 From the **Geometric entity level** list, choose **Domain**.

4 Select Domains 1–5 and 24–33 only.

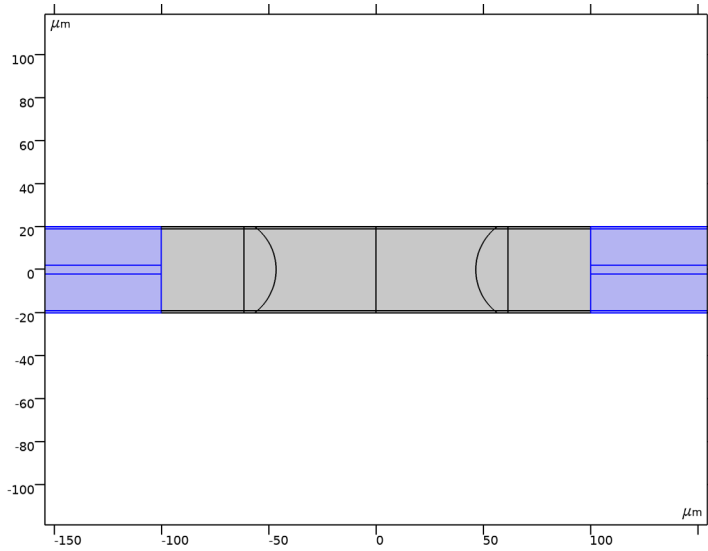

5 Locate the **Variables** section. In the table, enter the following settings:

Name	Expression	Unit	Description
psi	ewbe.beta_1*x	rad	

Variables 2

- 1 In the **Model Builder** window, right-click **Definitions** and choose **Variables**.
- 2 In the **Settings** window for **Variables**, locate the **Geometric Entity Selection** section.
- 3 From the **Geometric entity level** list, choose **Domain**.

4 Select Domains 6–23 only.

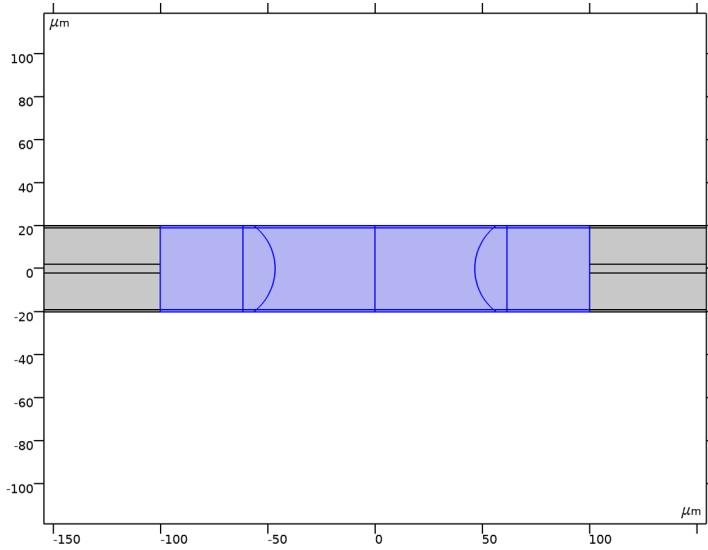

5 Locate the **Variables** section. In the table, enter the following settings:

Name	Expression	Unit	Description
psi	ewbe.k*x	rad	

Perfectly Matched Layer 1 (pml1)

1 In the **Definitions** toolbar, click  **Perfectly Matched Layer**.

- 2 Select Domains 1, 5, 6, 8, 9, 11–13, 15, 17, 19–21, 23, 24, and 28–33 only. This corresponds to the thin top, bottom, and right-most domains.

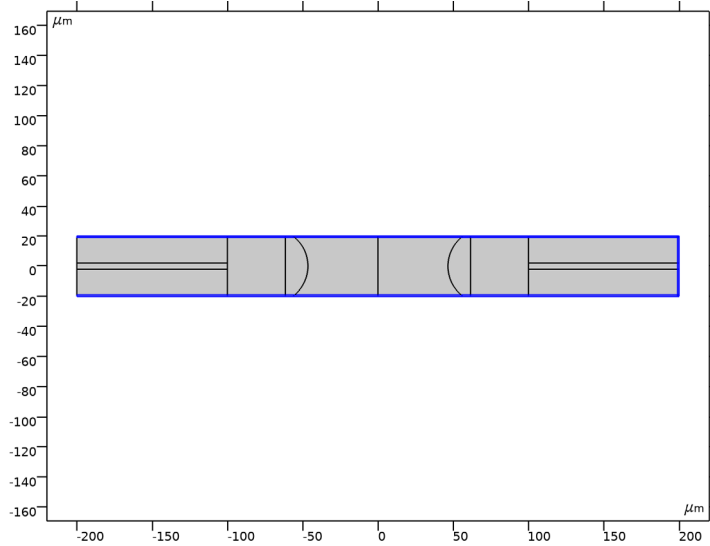

MESH 1

Define a mesh that resolves the variations of the field envelope.

- 1 In the **Model Builder** window, under **Component 1 (comp1)** right-click **Mesh 1** and choose **Build All**.
- 2 In the **Settings** window for **Mesh**, locate the **Mesh Settings** section.
- 3 From the **Sequence type** list, choose **User-controlled mesh**.

Distribution - Air Space

- 1 In the **Model Builder** window, under **Component 1 (comp1)**>**Mesh 1** click **Distribution 1**.
- 2 In the **Settings** window for **Distribution**, type **Distribution - Air Space** in the **Label** text field.
- 3 Locate the **Boundary Selection** section. Click  **Clear Selection**.

4 Select Boundaries 13, 28, 33, and 44 only.

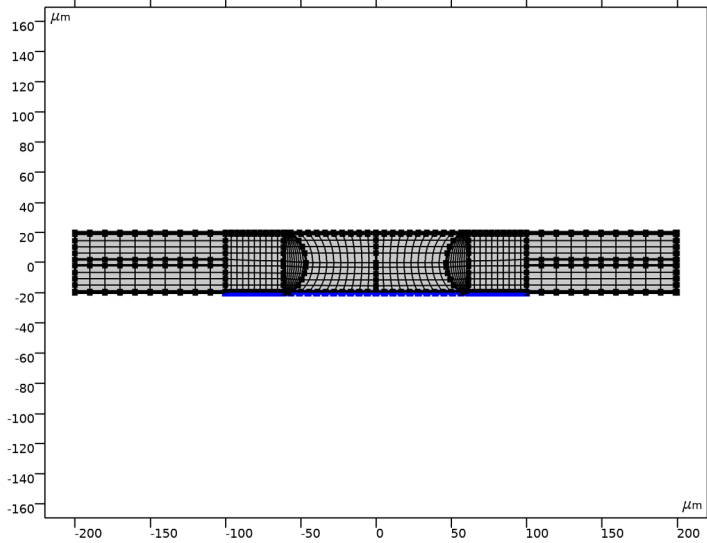

5 Locate the **Distribution** section. In the **Number of elements** text field, type 15.

Distribution - Core

- 1 In the **Model Builder** window, under **Component 1 (comp1)>Mesh 1** click **Distribution 2**.
- 2 In the **Settings** window for **Distribution**, type Distribution - Core in the **Label** text field.
- 3 Locate the **Boundary Selection** section. Click  **Clear Selection**.

4 Select Boundaries 5 and 74 only.

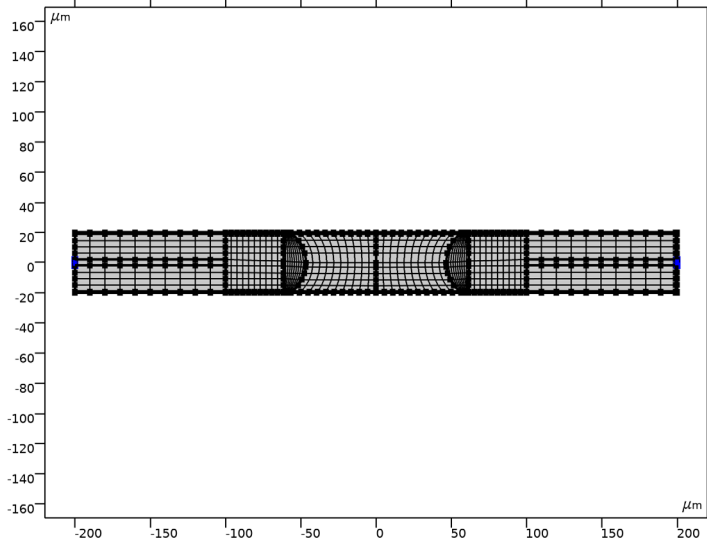

5 Locate the **Distribution** section. In the **Number of elements** text field, type 22.

Distribution - Cladding

- 1 In the **Model Builder** window, under **Component 1 (comp1)**>**Mesh 1** click **Distribution 3**.
- 2 In the **Settings** window for **Distribution**, type Distribution - Cladding in the **Label** text field.
- 3 Locate the **Boundary Selection** section. Click  **Clear Selection**.

4 Select Boundaries 3, 7, 73, and 75 only.

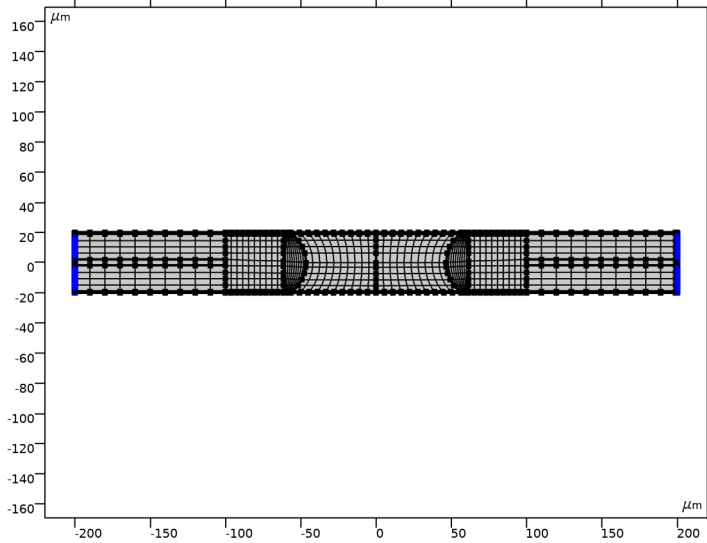

5 Locate the **Distribution** section. In the **Number of elements** text field, type 80.

Distribution - PML

- 1 In the **Model Builder** window, right-click **Mesh 1** and choose **Distribution**.
- 2 In the **Settings** window for **Distribution**, type Distribution - PML in the **Label** text field.
- 3 Locate the **Boundary Selection** section. Click  **Clear Selection**.

4 Select Boundaries 1, 9, 61, 64, 69, and 70 only.

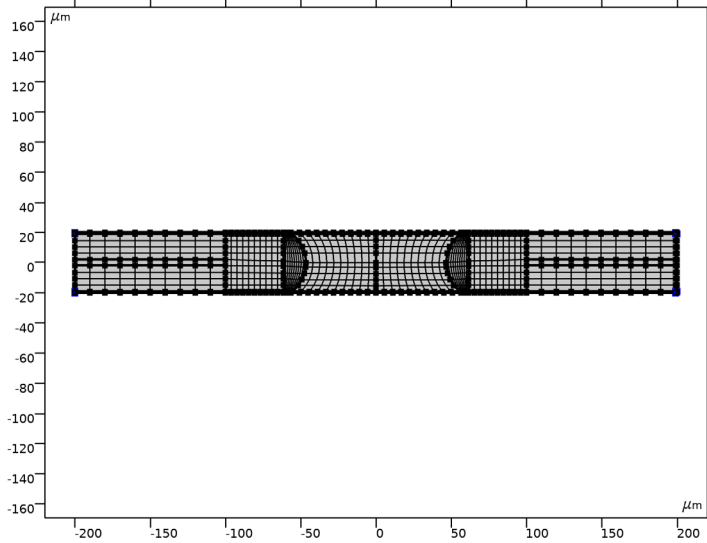

5 Locate the **Distribution** section. In the **Number of elements** text field, type 10.

6 Right-click **Distribution - PML** and choose **Move Up**.

Distribution - Input Fiber

1 In the **Model Builder** window, right-click **Mesh 1** and choose **Distribution**.

2 In the **Settings** window for **Distribution**, type **Distribution - Input Fiber** in the **Label** text field.

3 Select Boundary 2 only.

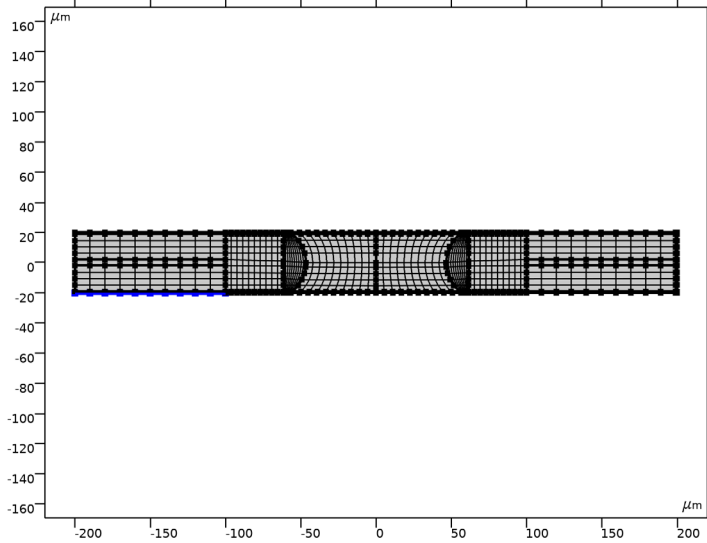

4 Locate the **Distribution** section. In the **Number of elements** text field, type 10.

Distribution - Output Fiber

1 Right-click **Mesh 1** and choose **Distribution**.

2 In the **Settings** window for **Distribution**, type Distribution - Output Fiber in the **Label** text field.

3 Select Boundary 51 only.

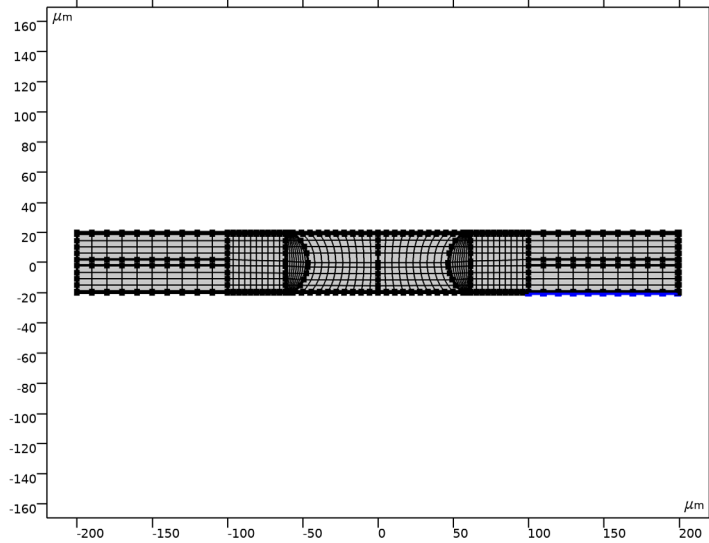

4 Locate the **Distribution** section. In the **Number of elements** text field, type 20.

Distribution - Lens

1 Right-click **Mesh 1** and choose **Distribution**.

2 In the **Settings** window for **Distribution**, type **Distribution - Lens** in the **Label** text field.

3 Select Boundaries 22 and 41 only.

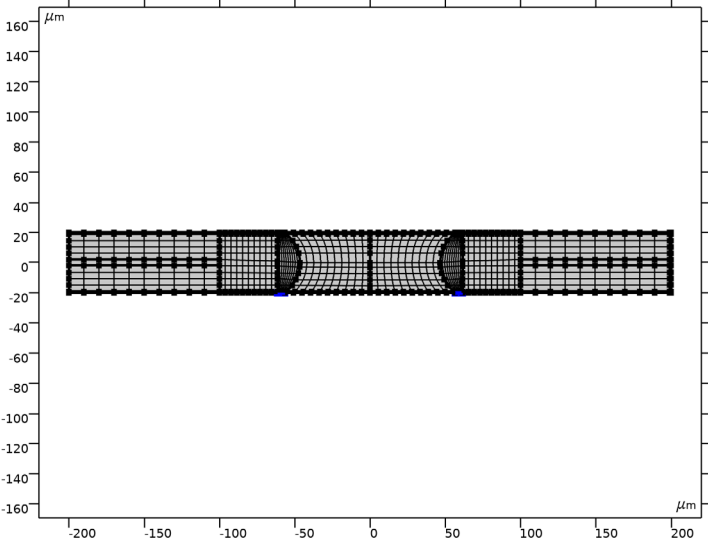

4 Click  Build All.

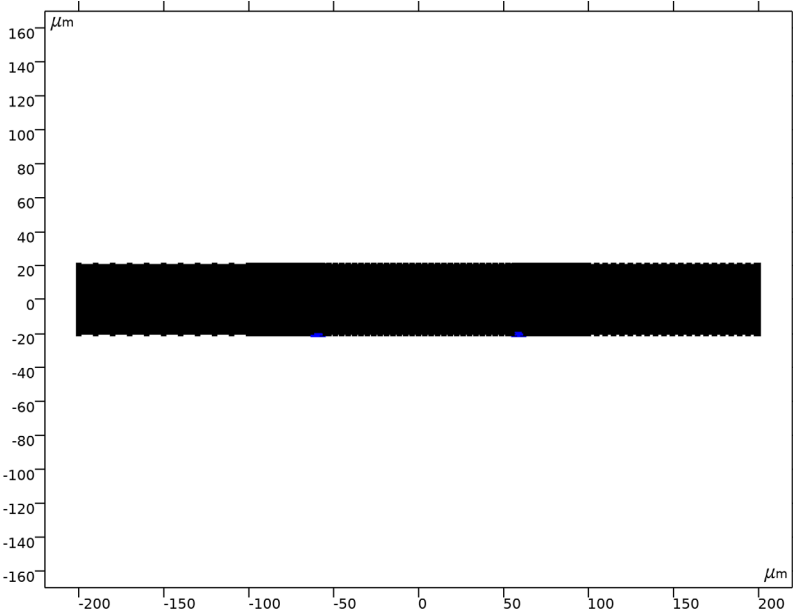

STUDY 1

Step 1: Boundary Mode Analysis

- 1 In the **Model Builder** window, under **Study 1** click **Step 1: Boundary Mode Analysis**.
- 2 In the **Settings** window for **Boundary Mode Analysis**, locate the **Study Settings** section.
- 3 In the **Mode analysis frequency** text field, type f_0 .
- 4 Select the **Search for modes around** check box.
- 5 In the associated text field, type n_{core} .

Step 3: Boundary Mode Analysis 1

- 1 Right-click **Study 1>Step 1: Boundary Mode Analysis** and choose **Duplicate**.
- 2 In the **Settings** window for **Boundary Mode Analysis**, locate the **Study Settings** section.
- 3 In the **Port name** text field, type 2.
- 4 Right-click **Step 3: Boundary Mode Analysis 1** and choose **Move Up**.

Step 3: Frequency Domain

- 1 In the **Model Builder** window, click **Step 3: Frequency Domain**.
- 2 In the **Settings** window for **Frequency Domain**, locate the **Study Settings** section.
- 3 In the **Frequencies** text field, type f_0 .

Parametric Sweep

- 1 In the **Study** toolbar, click  **Parametric Sweep**.
- 2 In the **Settings** window for **Parametric Sweep**, locate the **Study Settings** section.
- 3 Click **+ Add**.
- 4 In the table, click to select the cell at row number 1 and column number 1.
- 5 In the table, enter the following settings:

Parameter name	Parameter value list	Parameter unit
df (Focus adjustment)	-25 -20 -15 range (-10, 2, 10) 15 20 25	um

- 6 In the **Study** toolbar, click  **Compute**.

RESULTS

In the default reflectance and transmittance plot, replace the term absorptance everywhere with loss, as reflectance and transmittance here refer to what is reflected back into the guided mode of the input fiber and what is coupled into the guided mode of the output fiber, respectively. The light that is not transmitted to the guided mode of the output fiber

is not absorbed by any material, but lost to radiation modes other than the guided mode of the output fiber.

Reflectance, Transmittance, and Loss(ewbe)

- 1 In the **Model Builder** window, under **Results** click **Reflectance, Transmittance, and Absorptance (ewbe)**.
- 2 In the **Settings** window for **ID Plot Group**, type Reflectance, Transmittance, and Loss(ewbe) in the **Label** text field.
- 3 Locate the **Plot Settings** section. In the **y-axis label** text field, type Reflectance, transmittance, and loss (1).

Global I

- 1 In the **Model Builder** window, expand the **Reflectance, Transmittance, and Loss(ewbe)** node, then click **Global I**.
- 2 In the **Settings** window for **Global**, locate the **y-Axis Data** section.
- 3 In the table, click to select the cell at row number 3 and column number 1.
- 4 Click  **Delete**, to delete the less interesting variable representing the total transmittance and reflectance.

Replace also the description for the Absorptance variable with Loss.

- 5 In the table, enter the following settings:

Expression	Unit	Description
ewbe.Atotal	1	Loss

6 In the **Reflectance, Transmittance, and Loss(ewbe)** toolbar, click  **Plot**.

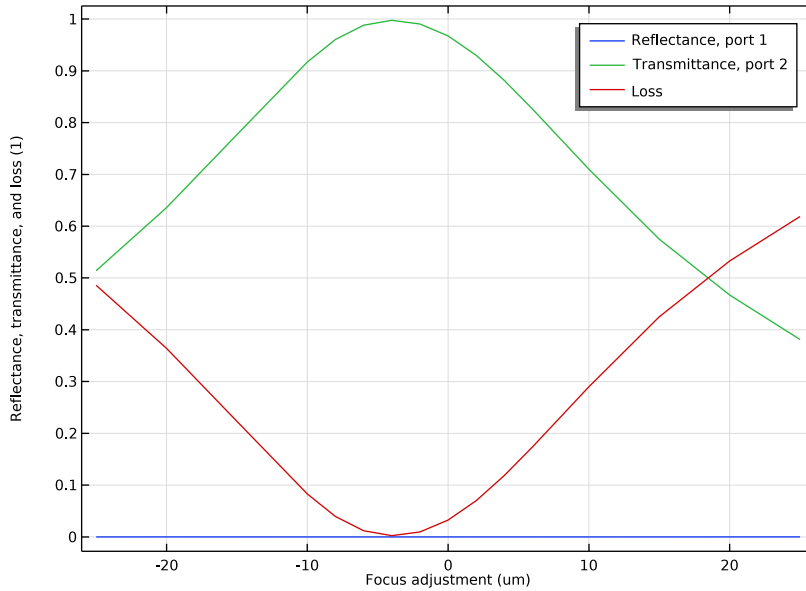

The coupling loss can be obtained from the plot above. The minimum value is found when the lenses are 4 μm closer to the fiber ends than the nominal focal length.

Electric Field (ewbe)

Finally, plot the field under conditions of maximum fiber-to-fiber coupling.

- 1 In the **Model Builder** window, click **Electric Field (ewbe)**.
- 2 In the **Settings** window for **2D Plot Group**, locate the **Data** section.
- 3 From the **Parameter value (df (um))** list, choose **-4**.

Electric Field

- 1 In the **Model Builder** window, expand the **Electric Field (ewbe)** node, then click **Electric Field**.
- 2 In the **Settings** window for **Surface**, locate the **Coloring and Style** section.
- 3 From the **Color table** list, choose **AuroraAustralis**.

4 In the **Electric Field (ewbe)** toolbar, click  **Plot**.

