



Leaky Modes in a Microstructured Optical Fiber

Introduction

In a regular optical fiber, light is confined to the core region of the fiber through total internal reflection. That is, the refractive index is higher in the core than in the surrounding cladding. Then if the wave hits the core-cladding interface with an angle from the interface normal that is larger than a certain critical angle, the wave will be perfectly reflected. Thus, ideally, this type of dielectric waveguide is lossless.

By the end of the seventies, it was realized that light could also be guided without relying on total internal reflection. If the core of the fiber was surrounded by concentric layers of materials with alternating high and low refractive indices, the modes can propagate along the fiber without losses, even though the core refractive index is lower than the refractive index of the exterior cladding. This type of fiber is called a Bragg fiber.

Also if you create a regular lattice of air holes in a silica fiber, a similar type of guiding as for the Bragg fiber can be created. This time, though, the guiding occurs through the photonic band gap effect. Consequently, these fibers are called photonic band gap fibers (PBGFs) or photonic crystal fibers (PCFs).

An advantage with these new kinds of fibers is that you can design them to make the guided mode overlap mainly with the air regions. This can potentially reduce the loss in the fiber and it makes the fibers less susceptible to optically nonlinear effects.

In reality, though, the band gap structures and the layer structures cannot be made infinitely large. Thus, there is always some loss associated with the modes in these microstructured optical fibers (MOFs). Thus, when designing these types of fibers, it is of great importance to be able to calculate the loss associated with a certain fiber design.

Model Definition

This model will demonstrate how to use COMSOL for making a mode analysis of a lossy microstructured optical fiber. The geometry is shown in [Figure 1](#).

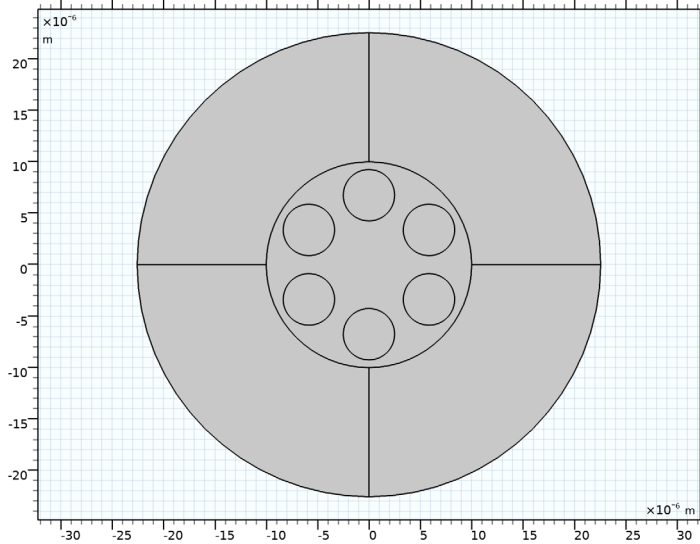

Figure 1: A microstructured optical fiber. The whole structure consists of silica, except for the small holes that consist of air. The outermost layer is used for the perfectly matched layer (PML), used in the first part of the simulation.

The fiber design implemented in this model has been used in several scientific papers for evaluating different computational methods. See for instance [Ref. 1](#).

Results and Discussion

Figure 2 shows one of the two degenerate HE_{11} -like modes. As this is a mixed mode, both the electric and magnetic field have longitudinal field components, although their magnitude is much smaller than the tangential field components.

Effective mode index=1.4454 Tangential and longitudinal electric and magnetic fields

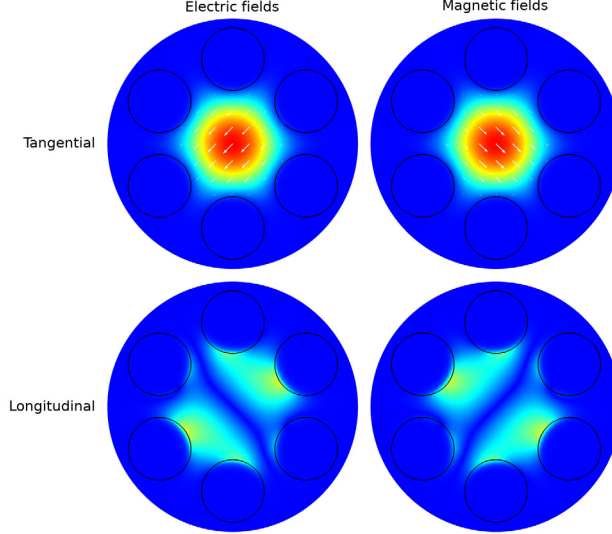

Figure 2: This graph shows the norm of the tangential and longitudinal electric and magnetic fields for one of the two degenerate HE_{11} -like modes. To make the longitudinal components visible, they are scaled by a factor of ten relative the tangential field components. The white arrows indicate the tangential electric and magnetic field directions.

This type of fiber is a high-index core fiber, where the core of the fiber has a higher refractive index than the surrounding air-hole ring. Thus, the guiding here could be said to be due to that the local effective index is higher in the core than in the surrounding air-hole ring.

You could also calculate the in-plane wavelength

$$\lambda_{T,i} = \frac{\lambda}{\sqrt{n^2 - n_i^2}}, \quad (1)$$

where λ is the vacuum wavelength, n is the refractive index of silica, and n_i is the effective index of mode i . For the modes with an effective index close to the silica refractive index, the in-plane wavelength will be much larger than the separation between the air holes.

Thus, less radiation can leak through the air-hole ring for those modes. When the effective index for the modes decreases, the in-plane wavelength gets smaller and more radiation can leak between the air holes.

Figure 3 shows the TE_{01} -like mode. A pure TE_{01} mode for a cylindrically symmetric waveguide, has rotational invariance. This TE_{01} -like mode has almost rotational invariance, with the electric field mainly polarized in the φ direction whereas the magnetic field has both a radial and longitudinal component.

Effective mode index=1.4386 Tangential and longitudinal electric and magnetic fields

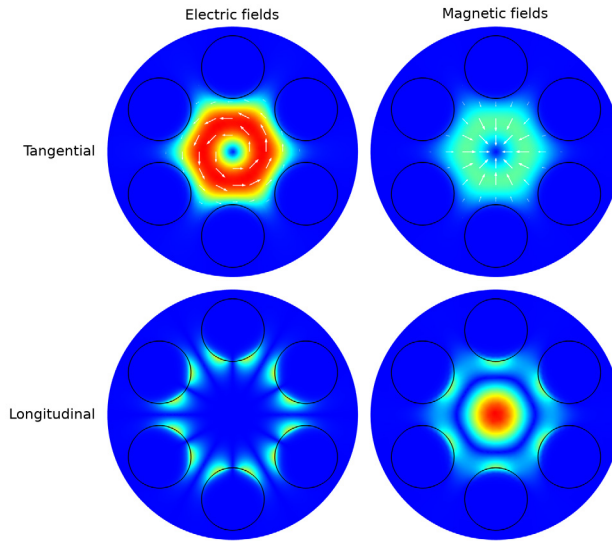

Figure 3: The TE_{01} -like mode.

Another mode example is the TM_{01} -like mode, shown in Figure 4. Again, the field has almost rotational invariance. However, this time the electric field has both radial and longitudinal components, whereas the magnetic field has mainly a φ -component.

Effective mode index=1.4384 Tangential and longitudinal electric and magnetic fields

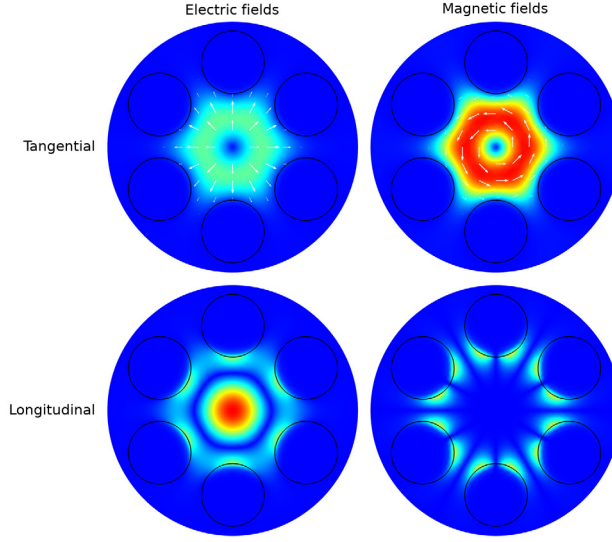

Figure 4: The TM_{01} -like mode.

Table 1 shows the effective indices for the ten modes found in the mode analysis studies. The first column indicates the mode's type. The second column, marked with PML, shows the result for the study performed with a PML to truncate the computation domain. The third column, shows the result for the study using a Scattering boundary condition to truncate the computation domain.

TABLE 1: COMPARISON OF EFFECTIVE INDICES.

MODE	PML	SBC
HE11	1.44539464 - 3.18614991E-8i	1.44539464 - 4.11689498E-8i
HE11	1.44539457 - 3.18633520E-8i	1.44539457 - 4.04012333E-8i
TE01	1.43858017 - 5.33455430E-7i	1.43858018 - 5.10491523E-7i
HE21	1.43844305 - 9.69173128E-7i	1.43844283 - 1.18177443E-6i
HE21	1.43844288 - 9.69308091E-7i	1.43844267 - 1.17332710E-6i
TM01	1.43836454 - 1.40665012E-6i	1.43836412 - 1.82745066E-6i
HE31	1.42925271 - 8.69622507E-6i	1.42925277 - 8.57312825E-6i

TABLE I: COMPARISON OF EFFECTIVE INDICES.

MODE	PML	SBC
EH11	1.42995211 - 1.58836822E-5i	1.42994979 - 1.14846411E-5i
EH11	1.42995194 - 1.58836249E-5i	1.42995007 - 1.17868693E-5i
HE31	1.43039731 - 2.15696869E-5i	1.43039277 - 1.42539834E-5i

As seen in the table, the real parts agree for the first 5–6 decimals, whereas for the much smaller imaginary parts only the orders of magnitude agree. Also when comparing to values reported in Ref. 1, the same kind of agreement is found.

Notes About the COMSOL Implementation

In the first part of the of this simulation, PMLs are used to truncate the simulation domain. To efficiently absorb the wave in the PML, the wavelength corresponding to the wave vector component in the radial direction should be provided. This wavelength is stated in Equation 1 and implemented by the parameter $w1r$, where an estimation of the largest effective index is used.

In the second part of this modeling task, the Scattering boundary condition is used for truncating the simulation domain. Normally, when the Scattering boundary condition is used, it is assumed that the scattered wave reaching the boundary propagates with a wave vector close to the normal direction to the boundary. However, when we do a mode analysis, we know that the mode will also propagate in the out-of-plane direction, which is tangential to the boundary where the Scattering boundary condition is applied. Thus, the wave vector component in the normal direction to the boundary is

$$k_n = \sqrt{k^2 - \beta^2},$$

where k is the material wave number and β is the propagation constant for the mode. To make sure that this expression is used, enable the **Subtract propagation constant from material wave number** check box in the **Mode Analysis** section in the **Settings** for the **Scattering Boundary Condition** feature.

Reference

1. H.P. Uranus and H.J.W.M. Hoekstra, “Modelling of microstructured waveguides using a finite-element-based vectorial mode solver with transparent boundary conditions,” *Optics Express*, vol. 12, no. 12, pp. 2795–2809, 2004.

Application Library path: Wave_Optics_Module/Verification_Examples/
microstructured_optical_fiber



Modeling Instructions

From the **File** menu, choose **New**.

NEW

In the **New** window, click  **Model Wizard**.

MODEL WIZARD

- 1 In the **Model Wizard** window, click  **2D**.
- 2 In the **Select Physics** tree, select **Optics>Wave Optics>Electromagnetic Waves, Frequency Domain (ewfd)**.
- 3 Click **Add**.
- 4 Click  **Study**.
- 5 In the **Select Study** tree, select **Preset Studies for Selected Physics Interfaces>Mode Analysis**.
- 6 Click  **Done**.

GLOBAL DEFINITIONS

Parameters 1

- 1 In the **Model Builder** window, under **Global Definitions** click **Parameters 1**.
- 2 In the **Settings** window for **Parameters**, locate the **Parameters** section.
- 3 Click  **Load from File**.
- 4 Browse to the model's Application Libraries folder and double-click the file `microstructured_optical_fiber_parameters.txt`.
The parameter `w1r`, the in-plane wavelength, will be used in the definition of the perfectly matched layer (PML).

GEOMETRY 1

Start building the geometry. Add a circle for the computation domain and then a smaller circle that represents the air holes. The air-hole circle is rotated in steps of 60 degrees. In total, six air holes will be added.

Circle 1 (c1)

- 1 In the **Geometry** toolbar, click  **Circle**.
- 2 In the **Settings** window for **Circle**, locate the **Size and Shape** section.
- 3 In the **Radius** text field, type $rb+w1r$.
- 4 Click to expand the **Layers** section. In the table, enter the following settings:

Layer name	Thickness (m)
Layer 1	$w1r$

Circle 2 (c2)

- 1 In the **Geometry** toolbar, click  **Circle**.
- 2 In the **Settings** window for **Circle**, locate the **Size and Shape** section.
- 3 In the **Radius** text field, type $d/2$.
- 4 Locate the **Position** section. In the **y** text field, type $-Delta$.
Now, give the selection a name that can be referred to later.
- 5 Locate the **Selections of Resulting Entities** section. Find the **Cumulative selection** subsection. Click **New**.
- 6 In the **New Cumulative Selection** dialog box, type Air Holes in the **Name** text field.
- 7 Click **OK**.

Rotate 1 (rot1)

- 1 In the **Geometry** toolbar, click  **Transforms** and choose **Rotate**.
- 2 Select the object **c2** only.
- 3 In the **Settings** window for **Rotate**, locate the **Rotation** section.
- 4 In the **Angle** text field, type $range(0, 60, 300)$.
- 5 Locate the **Selections of Resulting Entities** section. Find the **Cumulative selection** subsection. From the **Contribute to** list, choose **Air Holes**.

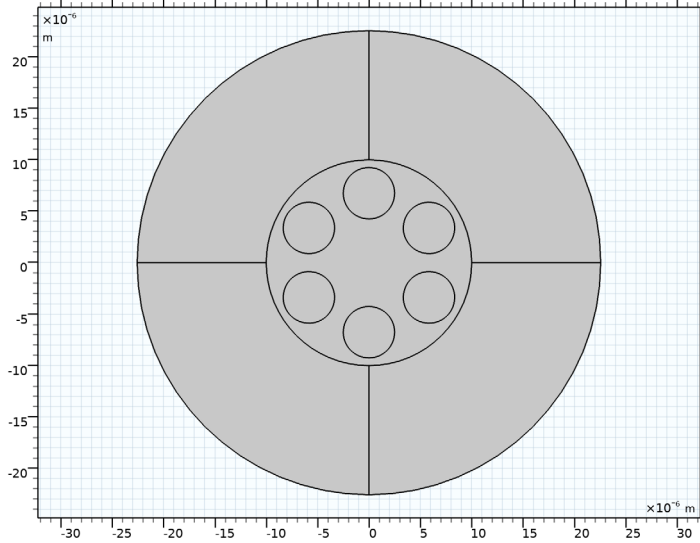

6 Click  **Build All Objects.**



Add a selection for the air hole boundaries. This selection will be used later, when setting up the plots.

DEFINITIONS

Air Hole Boundaries

- 1 In the **Definitions** toolbar, click  **Adjacent**.
- 2 In the **Settings** window for **Adjacent**, type Air Hole Boundaries in the **Label** text field.
- 3 Locate the **Input Entities** section. Under **Input selections**, click  **Add**.
- 4 In the **Add** dialog box, select **Air Holes** in the **Input selections** list.

5 Click **OK**.

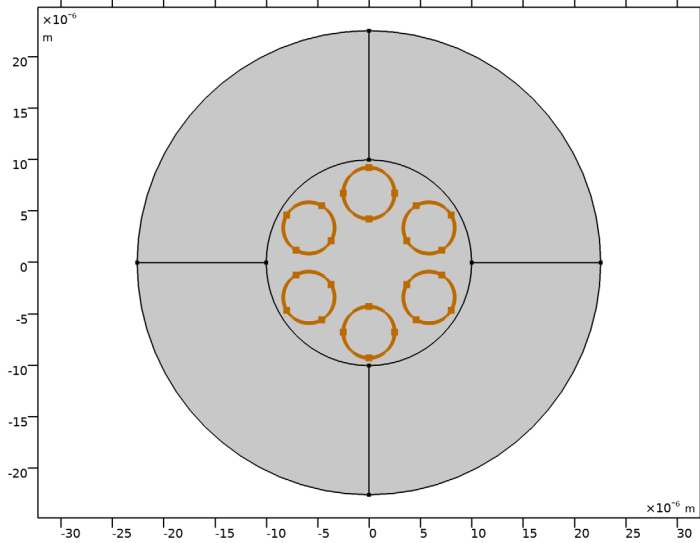

MATERIALS

Now, add the materials.

Silica

- 1 In the **Model Builder** window, under **Component 1 (comp1)** right-click **Materials** and choose **Blank Material**.
- 2 In the **Settings** window for **Material**, type Silica in the **Label** text field.
- 3 Locate the **Material Contents** section. In the table, enter the following settings:

Property	Variable	Value	Unit	Property group
Refractive index, real part	n_iso ; $nii = n_iso$, $nij = 0$	nbg	1	Refractive index
Refractive index, imaginary part	ki_iso ; $kiii =$ ki_iso , $kij = 0$	0	1	Refractive index

Air

- 1 Right-click **Materials** and choose **Blank Material**.
- 2 In the **Settings** window for **Material**, type Air in the **Label** text field.

3 Locate the **Geometric Entity Selection** section. From the **Selection** list, choose **Air Holes**.

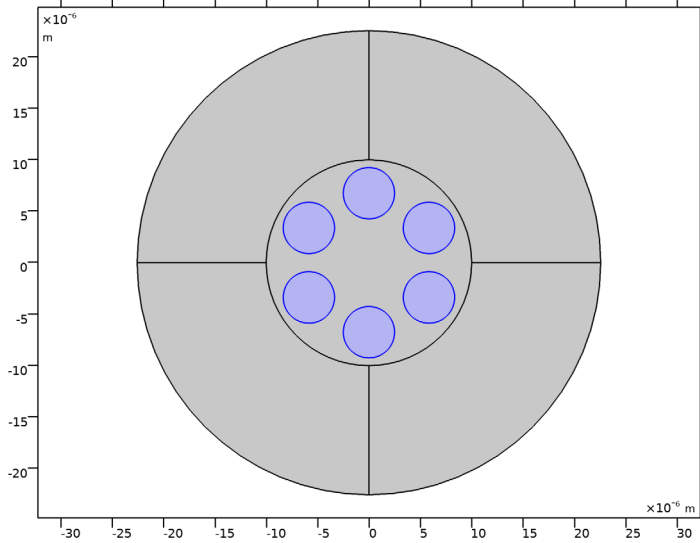

4 Locate the **Material Contents** section. In the table, enter the following settings:

Property	Variable	Value	Unit	Property group
Refractive index, real part	n_iso ; $n_{ii} = n_iso$, $n_{ij} = 0$	n_{air}	1	Refractive index
Refractive index, imaginary part	k_i_iso ; $k_{iii} =$ k_i_iso , $k_{ij} = 0$	0	1	Refractive index

DEFINITIONS

In the first part of the model, a perfectly matched layer (PML) will be used for truncating the computation domain.

Perfectly Matched Layer 1 (pml1)

1 In the **Definitions** toolbar, click  **Perfectly Matched Layer**.

2 Select Domains 1–4 only.

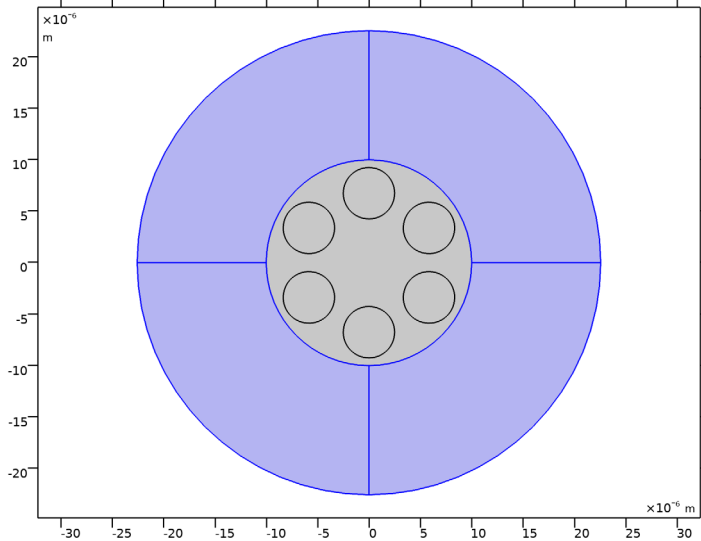

3 In the **Settings** window for **Perfectly Matched Layer**, locate the **Geometry** section.

4 From the **Type** list, choose **Cylindrical**.

5 Locate the **Scaling** section. From the **Typical wavelength from** list, choose **User defined**.

6 In the **Typical wavelength** text field, type $w1r$. This parameter approximates the in-plane wavelength.

STUDY 1

Step 1: Mode Analysis

1 In the **Model Builder** window, under **Study 1** click **Step 1: Mode Analysis**.

2 In the **Settings** window for **Mode Analysis**, locate the **Study Settings** section.

3 In the **Mode analysis frequency** text field, type $c_const/w1$.

4 From the **Mode search method** list, choose **Region**, as we will search for the complex effective indices in a rectangular region defined by the following parameters.

5 In the **Approximate number of modes** text field, type 10.

6 Find the **Search region** subsection. In the **Smallest real part** text field, type n_{effMin} .

7 In the **Largest real part** text field, type n_{effMax} .

8 In the **Smallest imaginary part** text field, type $-3e-5$.

MESH 1

- 1 In the **Model Builder** window, under **Component 1 (comp1)** click **Mesh 1**.
- 2 In the **Settings** window for **Mesh**, locate the **Physics-Controlled Mesh** section.
- 3 From the **Element size** list, choose **Extremely fine**.
- 4 Click  **Build All**.

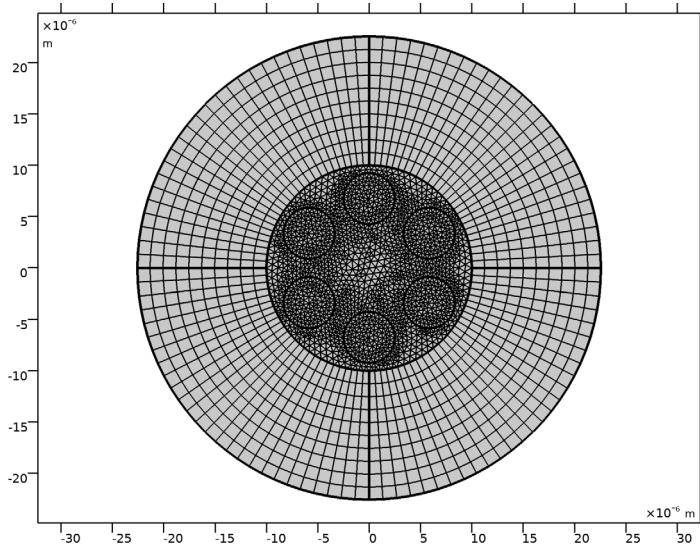

The mesh plot shows that the PML domains have been meshed with a mapped mesh.



STUDY 1

Step 1: Mode Analysis

In the **Home** toolbar, click  **Compute**.

RESULTS

Electric Field (ewfd)

- 1 In the **Settings** window for **2D Plot Group**, locate the **Color Legend** section.
- 2 Clear the **Show legends** check box, as the absolute amplitude of the mode field is not important.
- 3 In the **Electric Field (ewfd)** toolbar, click  **Plot**.
- 4 Click the  **Show Grid** button in the **Graphics** toolbar, to remove some more information that is not necessary in the plot.

5 Click the  **Zoom Extents** button in the **Graphics** toolbar.

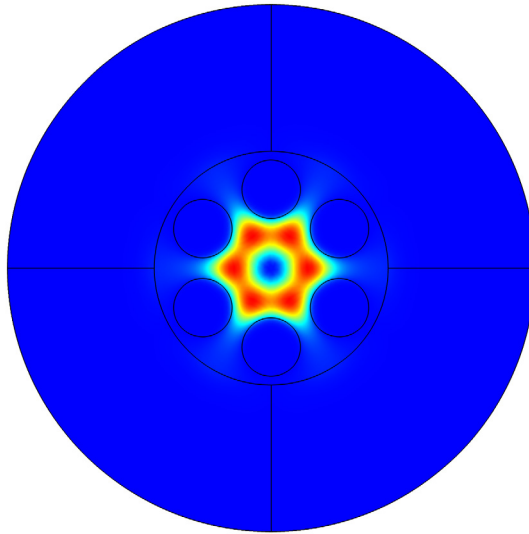

Effective mode index=1.4304-2.157E-5i Surface: Electric field norm (V/m)



As seen, the mode field is localized to the central high-index region, with only a very small part of the field penetrating in between the holes.

The effective index is shown in the plot title. As seen, it is a complex number, where the imaginary part represents attenuation of the wave as it propagates along the fiber due to radiation leaking through the air-hole ring. Let's evaluate the effective indices for the different modes.

Global Evaluation 1

- 1 In the **Results** toolbar, click  **Global Evaluation**.
- 2 In the **Settings** window for **Global Evaluation**, click **Replace Expression** in the upper-right corner of the **Expressions** section. From the menu, choose **Component 1 (comp1)> Electromagnetic Waves, Frequency Domain>Global>ewfd.neff - Effective mode index**.
- 3 Click  **Evaluate**.

TABLE

- 1 Go to the **Table** window.

2 Click **Full Precision** in the window toolbar.

The imaginary part of the effective index is larger for the modes with a lower real part of the effective index. Those modes have a smaller in-plane wavelength and are, thus, more loosely bound the central high-index region.

The effective indices in the table should be very close to the values in the second column of [Table 1](#).

ELECTROMAGNETIC WAVES, FREQUENCY DOMAIN (EWFD)

Now, replace the PML with a Scattering boundary condition (SBC).

1 In the **Model Builder** window, under **Component 1 (comp1)** click **Electromagnetic Waves, Frequency Domain (ewfd)**.

2 Select Domains 5–11 only.

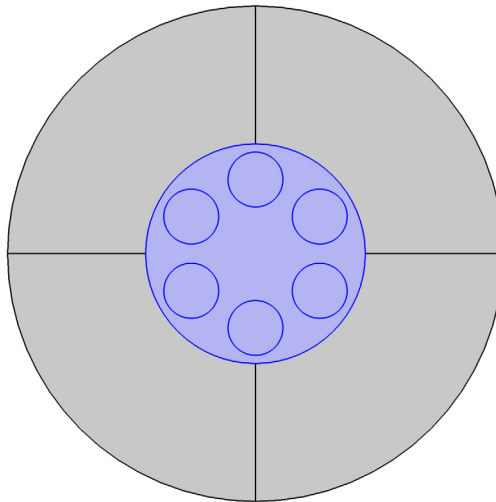

Scattering Boundary Condition 1

1 In the **Physics** toolbar, click  **Boundaries** and choose **Scattering Boundary Condition**.

2 In the **Settings** window for **Scattering Boundary Condition**, locate the **Boundary Selection** section.

3 From the **Selection** list, choose **All boundaries**.

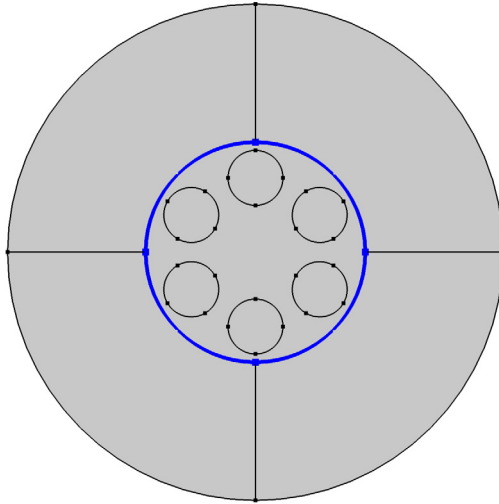

- 4 Locate the **Scattering Boundary Condition** section. From the **Scattered wave type** list, choose **Cylindrical wave**.
- 5 Click to expand the **Mode Analysis** section. Select the **Subtract propagation constant from material wave number** check box, to subtract the mode's propagation constant from the material wave number when calculating the wave vector component in the radial (normal) direction.
- 6 In the **Home** toolbar, click **Compute**.

RESULTS

Global Evaluation 1

- 1 In the **Model Builder** window, under **Results>Derived Values** click **Global Evaluation 1**.
- 2 In the **Settings** window for **Global Evaluation**, click **Evaluate**.

The effective indices in the table should be very close to the values in the third column of [Table 1](#).

Comparing the effective indices from the PML and the SBC simulations, it is clear that the real parts agree up to 4–5 decimals, whereas the imaginary parts (that are much smaller in magnitude) only agree by the order of magnitude.

Electric Field (ewfd)

Now, add some additional plots, to make it possible to distinguish the different mode types.

Surface 1

- 1 In the **Model Builder** window, expand the **Results>Electric Field (ewfd)** node, then click **Surface 1**.
- 2 In the **Settings** window for **Surface**, locate the **Expression** section.
- 3 In the **Expression** text field, type $\text{sqrt}(\text{abs}(\text{ewfd}.\text{Ex})^2 + \text{abs}(\text{ewfd}.\text{Ey})^2)$. This represents the norm of the tangential electric field.

Effective mode index=1.4304 Surface: $\text{sqrt}(\text{abs}(\text{ewfd}.\text{Ex})^2 + \text{abs}(\text{ewfd}.\text{Ey})^2)$ (V/m)

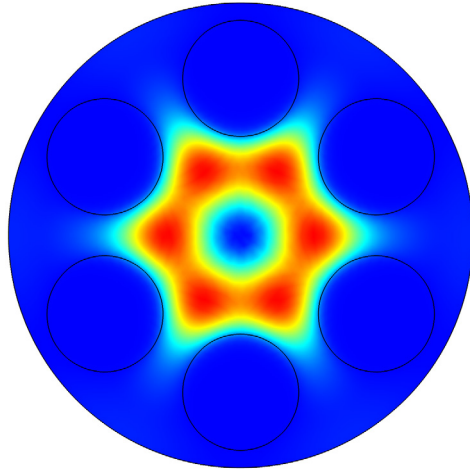

Surface 2

- 1 Right-click **Results>Electric Field (ewfd)>Surface 1** and choose **Duplicate**.
- 2 In the **Settings** window for **Surface**, locate the **Expression** section.
- 3 In the **Expression** text field, type $10 * \text{abs}(\text{ewfd}.\text{Ez})$. This represents the norm of the longitudinal electric field. This component is scaled by a factor of ten, to make it visible when compared to the tangential electric field components.
- 4 Click to expand the **Inherit Style** section. From the **Plot** list, choose **Surface 1**.

Deformation 1

- 1 Right-click **Surface 2** and choose **Deformation**.
- 2 In the **Settings** window for **Deformation**, locate the **Expression** section.

- 3 In the **Y component** text field, type $-2.1 \cdot r_b$.
- 4 Locate the **Scale** section. Select the **Scale factor** check box.
- 5 In the associated text field, type 1.
- 6 Click the  **Zoom Extents** button in the **Graphics** toolbar.

Effective mode index=1.4304 Surface: $\sqrt{\text{abs}(\text{ewfd.Ex})^2 + \text{abs}(\text{ewfd.Ey})^2}$ (V/m)
 Surface: $10 \cdot \text{abs}(\text{ewfd.Ez})$ (V/m)

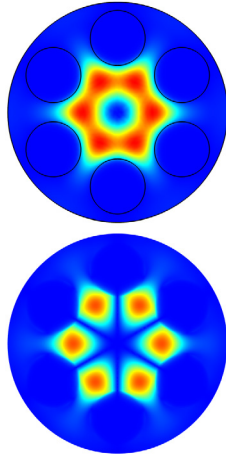

Surface 1, Surface 2

In the **Model Builder** window, under **Results>Electric Field (ewfd)**, Ctrl-click to select **Surface 1** and **Surface 2**.

Surface 3

- 1 Right-click and choose **Duplicate**.
- 2 In the **Settings** window for **Surface**, locate the **Expression** section.
- 3 In the **Expression** text field, type $\sqrt{\text{abs}(\text{ewfd.Hx})^2 + \text{abs}(\text{ewfd.Hy})^2}$. This represents the norm of the tangential magnetic field.

Deformation 1

- 1 Right-click **Surface 3** and choose **Deformation**.
- 2 In the **Settings** window for **Deformation**, locate the **Expression** section.
- 3 In the **X component** text field, type $2.1 \cdot r_b$.
- 4 Locate the **Scale** section. Select the **Scale factor** check box.
- 5 In the associated text field, type 1.

6 Click the  **Zoom Extents** button in the **Graphics** toolbar.

Effective mode index=1.4304 Surface: $\sqrt{\text{abs}(\text{ewfd.Ex})^2 + \text{abs}(\text{ewfd.Ey})^2}$ (V/m)
Surface: $10 \cdot \text{abs}(\text{ewfd.Ez})$ (V/m)
Surface: $\sqrt{\text{abs}(\text{ewfd.Hx})^2 + \text{abs}(\text{ewfd.Hy})^2}$ (A/m)
Surface: $10 \cdot \text{abs}(\text{ewfd.Ez})$ (V/m)

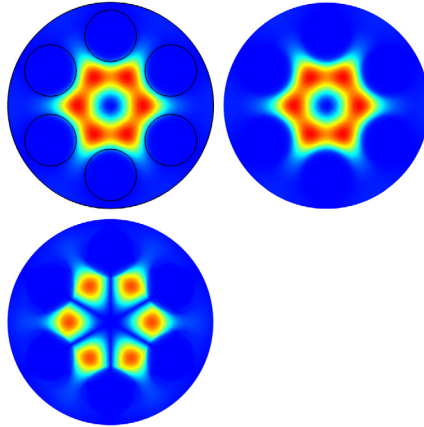

Surface 4

- 1 In the **Model Builder** window, expand the **Results>Electric Field (ewfd)>Surface 4** node, then click **Surface 4**.
- 2 In the **Settings** window for **Surface**, locate the **Expression** section.
- 3 In the **Expression** text field, type $10 \cdot \text{abs}(\text{ewfd.Hz})$. This represents the norm of the longitudinal magnetic field. Again, a scale factor of 10 is used here to make the longitudinal component visible when compared to the tangential components.
- 4 Locate the **Inherit Style** section. From the **Plot** list, choose **Surface 3**.

Deformation 1

- 1 In the **Model Builder** window, click **Deformation 1**.
- 2 In the **Settings** window for **Deformation**, locate the **Expression** section.

3 In the **X component** text field, type $2.1*rb$.

Effective mode index=1.4304 Surface: $\sqrt{\text{abs}(\text{ewfd.Ex})^2 + \text{abs}(\text{ewfd.Ey})^2}$ (V/m)
Surface: $10*\text{abs}(\text{ewfd.Ez})$ (V/m)
Surface: $\sqrt{\text{abs}(\text{ewfd.Hx})^2 + \text{abs}(\text{ewfd.Hy})^2}$ (A/m)
Surface: $10*\text{abs}(\text{ewfd.Hz})$ (A/m)

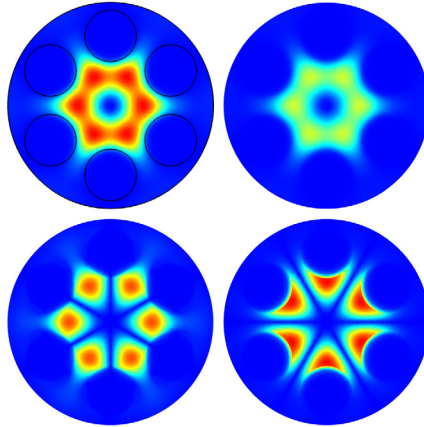

Electric Field (ewfd)

- 1 In the **Model Builder** window, click **Electric Field (ewfd)**.
- 2 In the **Settings** window for **2D Plot Group**, click to expand the **Title** section.
- 3 From the **Title type** list, choose **Manual**.
- 4 In the **Title** text area, type Tangential and longitudinal electric and magnetic fields.

Add arrow plots to visualize the polarization direction.

Arrow Surface 1

- 1 Right-click **Electric Field (ewfd)** and choose **Arrow Surface**.
- 2 In the **Settings** window for **Arrow Surface**, locate the **Coloring and Style** section.
- 3 From the **Color** list, choose **White**.

Deformation 1

- 1 Right-click **Arrow Surface 1** and choose **Deformation**.
- 2 In the **Settings** window for **Deformation**, locate the **Expression** section.
- 3 In the **X component** text field, type $2.1*rb$.
- 4 Locate the **Scale** section. Select the **Scale factor** check box.

5 In the associated text field, type 1.

Effective mode index=1.4304 Tangential and longitudinal electric and magnetic fields

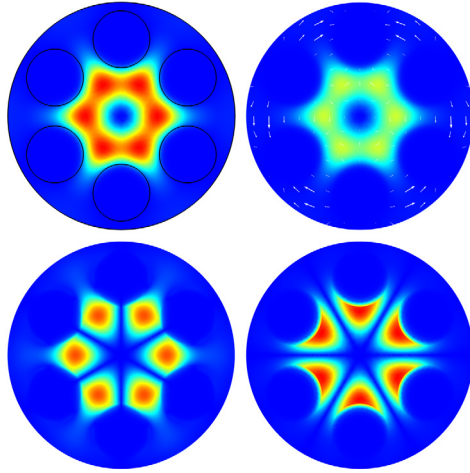

Arrow Surface 2

- 1 In the **Model Builder** window, under **Results>Electric Field (ewfd)** right-click **Arrow Surface 1** and choose **Duplicate**.
- 2 In the **Settings** window for **Arrow Surface**, click **Replace Expression** in the upper-right corner of the **Expression** section. From the menu, choose **Component 1 (comp1)>Electromagnetic Waves, Frequency Domain>Electric>ewfd.Ex,ewfd.Ey - Electric field**.

Deformation 1

- 1 In the **Model Builder** window, expand the **Arrow Surface 2** node.
- 2 Right-click **Deformation 1** and choose **Delete**.

To clearly see the different polarization directions for the two degenerate modes with the highest effective indices, it helps here to change the phase of the solution 45 degrees. Another option to see the different polarization directions, would be to make an animation of one harmonic period.

Study 1/Solution 1 (sol1)

- 1 In the **Model Builder** window, expand the **Results>Datasets** node, then click **Study 1/Solution 1 (sol1)**.
- 2 In the **Settings** window for **Solution**, locate the **Solution** section.
- 3 In the **Solution at angle (phase)** text field, type 45.

Arrow Surface 2

Effective mode index=1.4304 Tangential and longitudinal electric and magnetic fields

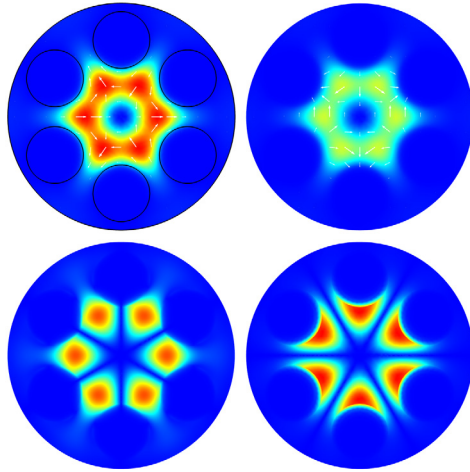

Electric Field (ewfd)

Now, remove the black edges and then add them back using line plots. This will make the location of the air holes more visible.

- 1 In the **Model Builder** window, click **Electric Field (ewfd)**.
- 2 In the **Settings** window for **2D Plot Group**, locate the **Plot Settings** section.

3 Clear the **Plot dataset edges** check box.

Effective mode index=1.4304 Tangential and longitudinal electric and magnetic fields

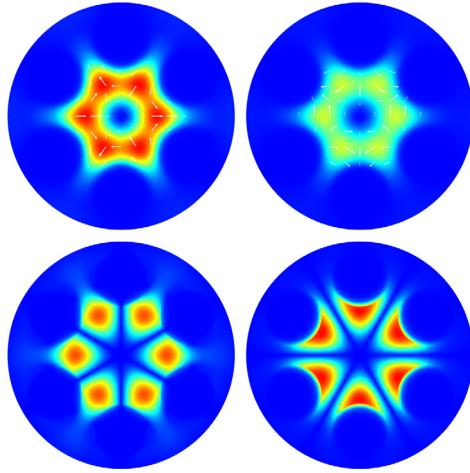

Line 1

- 1 Right-click **Electric Field (ewfd)** and choose **Line**.
- 2 In the **Settings** window for **Line**, locate the **Coloring and Style** section.
- 3 From the **Coloring** list, choose **Uniform**.
- 4 From the **Color** list, choose **Black**.

Selection 1

- 1 Right-click **Line 1** and choose **Selection**.
- 2 In the **Settings** window for **Selection**, locate the **Selection** section.

3 From the **Selection** list, choose **Air Hole Boundaries**.

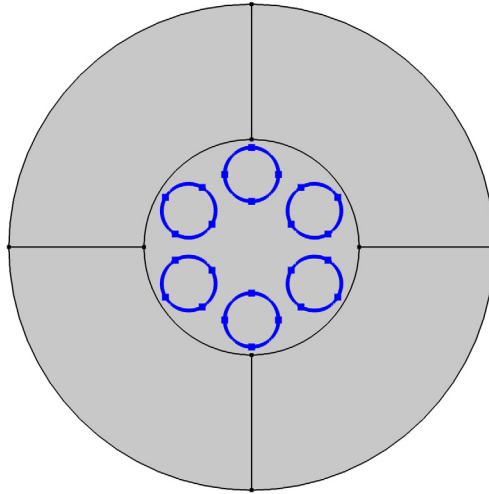

Line 2

In the **Model Builder** window, under **Results>Electric Field (ewfd)** right-click **Line 1** and choose **Duplicate**.

Deformation 1

- 1 In the **Model Builder** window, right-click **Line 2** and choose **Deformation**.
- 2 In the **Settings** window for **Deformation**, locate the **Expression** section.
- 3 In the **X component** text field, type $2.1*rb$.
- 4 Locate the **Scale** section. Select the **Scale factor** check box.

5 In the associated text field, type 1.

Effective mode index=1.4304 Tangential and longitudinal electric and magnetic fields

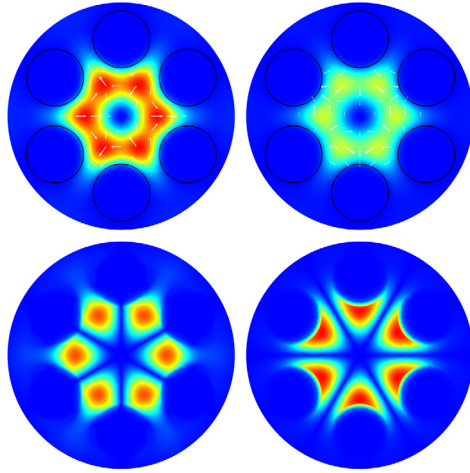

Line 1, Line 2

In the **Model Builder** window, under **Results>Electric Field (ewfd)**, Ctrl-click to select **Line 1** and **Line 2**.

Line 3

Right-click and choose **Duplicate**.

Deformation 1

- 1 In the **Model Builder** window, right-click **Line 3** and choose **Deformation**.
- 2 In the **Settings** window for **Deformation**, locate the **Expression** section.
- 3 In the **Y component** text field, type $-2.1 \cdot r_b$.
- 4 Locate the **Scale** section. Select the **Scale factor** check box.

5 In the associated text field, type 1.

Effective mode index=1.4304 Tangential and longitudinal electric and magnetic fields

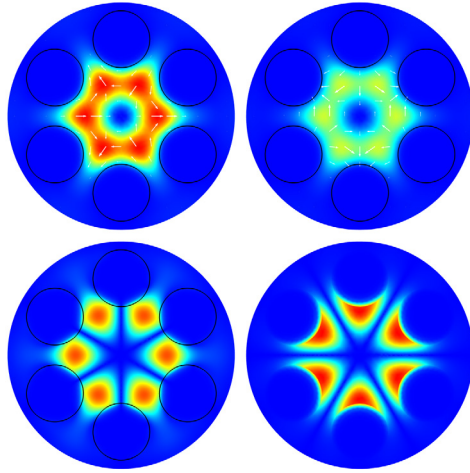

Deformation 1

- 1 In the **Model Builder** window, expand the **Results>Electric Field (ewfd)>Line 4** node, then click **Deformation 1**.
- 2 In the **Settings** window for **Deformation**, locate the **Expression** section.

3 In the **Y component** text field, type $-2.1*rb$.

Effective mode index=1.4304 Tangential and longitudinal electric and magnetic fields

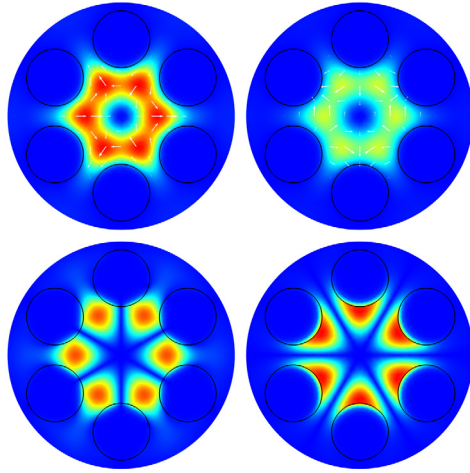

Electric Field (ewfd)

Finally, add some informative annotations.

Annotation 1

- 1 In the **Model Builder** window, right-click **Electric Field (ewfd)** and choose **Annotation**.
- 2 In the **Settings** window for **Annotation**, locate the **Annotation** section.
- 3 In the **Text** text field, type Electric fields.
- 4 Locate the **Position** section. In the **Y** text field, type $1.1*rb$.
- 5 Locate the **Coloring and Style** section. Clear the **Show point** check box.
- 6 From the **Anchor point** list, choose **Center**.

7 Click the  **Zoom Extents** button in the **Graphics** toolbar.

Effective mode index=1.4304 Tangential and longitudinal electric and magnetic fields

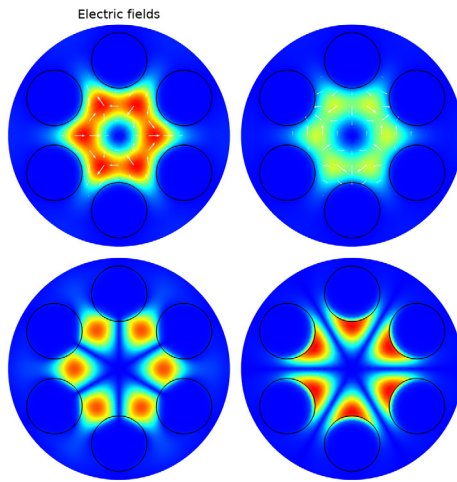

Annotation 2

- 1 Right-click **Annotation 1** and choose **Duplicate**.
- 2 In the **Settings** window for **Annotation**, locate the **Annotation** section.
- 3 In the **Text** text field, type Magnetic fields.

4 Locate the **Position** section. In the **X** text field, type $2.1 * r_b$.

Effective mode index=1.4304 Tangential and longitudinal electric and magnetic fields

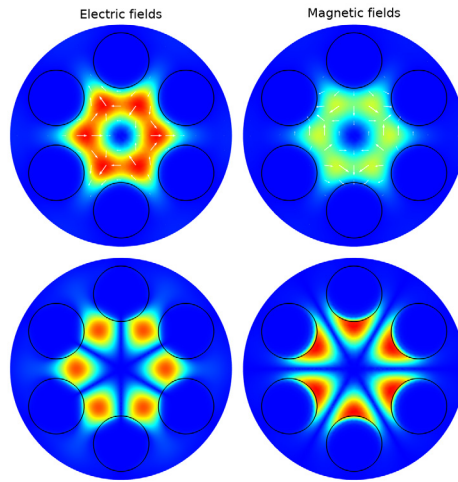

Annotation 3

- 1 In the **Model Builder** window, under **Results>Electric Field (ewfd)** right-click **Annotation 1** and choose **Duplicate**.
- 2 In the **Settings** window for **Annotation**, locate the **Annotation** section.
- 3 In the **Text** text field, type **Tangential**.
- 4 Locate the **Position** section. In the **X** text field, type $-1.1 * r_b$.
- 5 In the **Y** text field, type **0**.
- 6 Locate the **Coloring and Style** section. From the **Anchor point** list, choose **Middle right**.

7 Click the  **Zoom Extents** button in the **Graphics** toolbar.

Effective mode index=1.4304 Tangential and longitudinal electric and magnetic fields

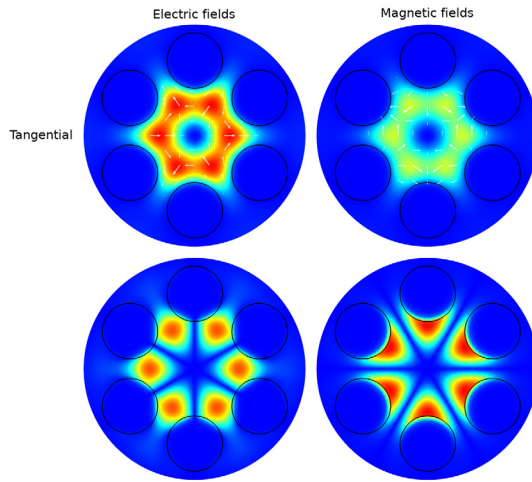

Annotation 4

- 1 Right-click **Annotation 3** and choose **Duplicate**.
- 2 In the **Settings** window for **Annotation**, locate the **Annotation** section.
- 3 In the **Text** text field, type Longitudinal.

4 Locate the **Position** section. In the **Y** text field, type $-2.1*rb$.

Effective mode index=1.4304 Tangential and longitudinal electric and magnetic fields

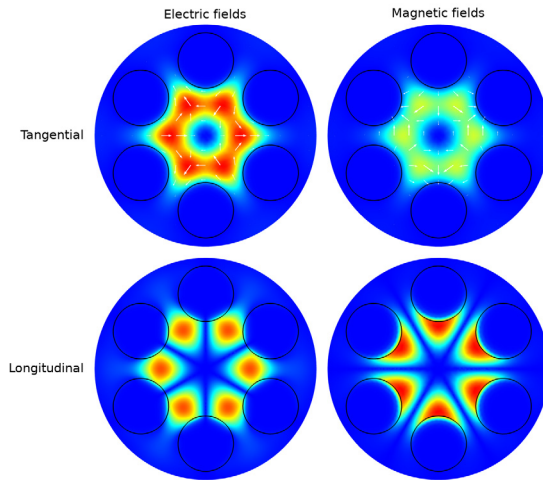

Electric Field (ewfd)

- 1 In the **Model Builder** window, click **Electric Field (ewfd)**.
- 2 In the **Settings** window for **2D Plot Group**, locate the **Title** section.
- 3 Select the **Allow evaluation of expressions** check box.
- 4 In the **Parameter indicator** text field, type `Effective mode index=eval(ewfd.neff)`, to update the effective index in the title.

Now it is time to analyze the mode types, by stepping through the modes, starting with the mode with the largest effective index.

5 Click → Plot Last.

Effective mode index=1.4454 Tangential and longitudinal electric and magnetic fields

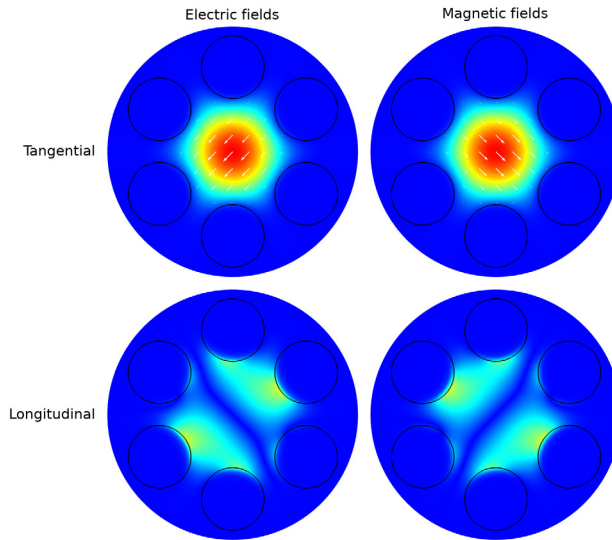

This is the first HE_{11} -like mode. These modes are degenerate with a degeneracy of two. This mixed mode has both longitudinal electric and magnetic field components.

6 Click ← Plot Previous.

Effective mode index=1.4454 Tangential and longitudinal electric and magnetic fields

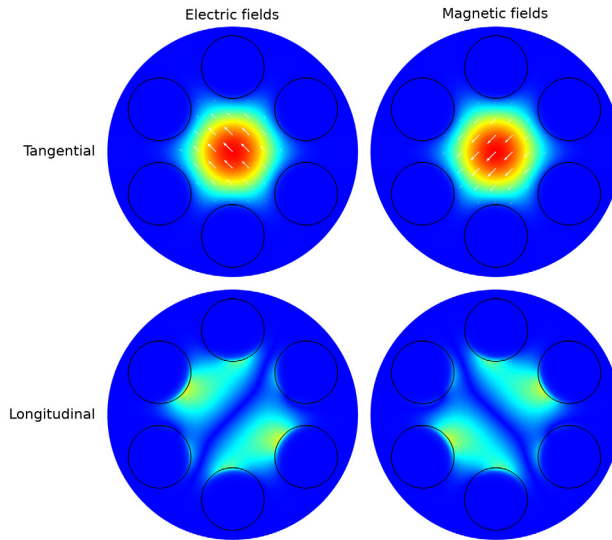

This is the second degenerate HE_{11} -like mode. The polarization is of course orthogonal to the first HE_{11} -like mode.

7 Click ← Plot Previous.

Effective mode index=1.4386 Tangential and longitudinal electric and magnetic fields

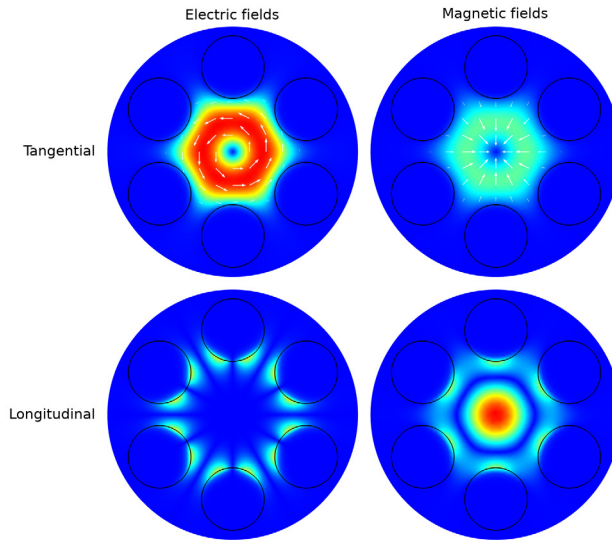

This is a TE_{01} -like mode, where the field is almost rotationally invariant and polarized in the ϕ direction. As seen, the longitudinal electric field is very small, whereas the longitudinal magnetic field is non-negligible.

8 Click ← Plot Previous.

Effective mode index=1.4384 Tangential and longitudinal electric and magnetic fields

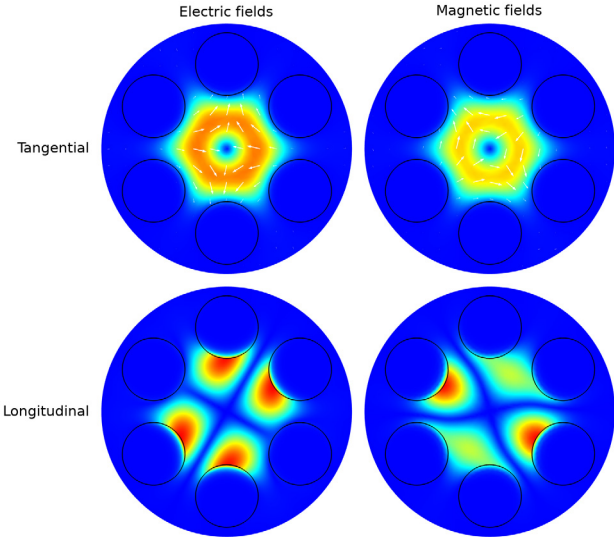

This is the first degenerate HE_{21} -like mode.

9 Click ← Plot Previous.

Effective mode index=1.4384 Tangential and longitudinal electric and magnetic fields

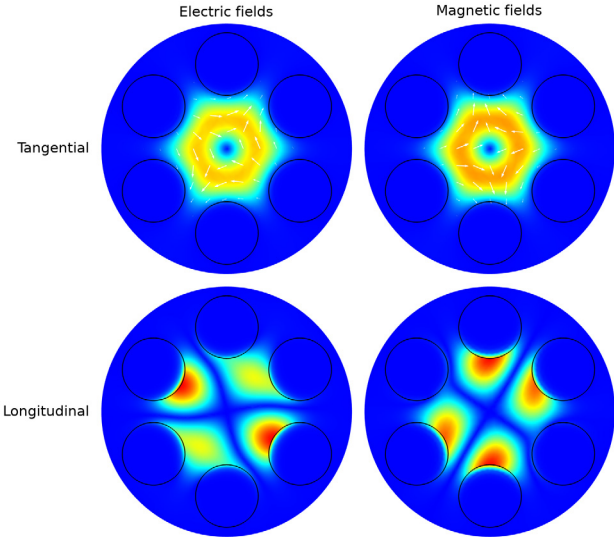

This is the second degenerate HE_{21} -like mode.

10 Click ← Plot Previous.

Effective mode index=1.4384 Tangential and longitudinal electric and magnetic fields

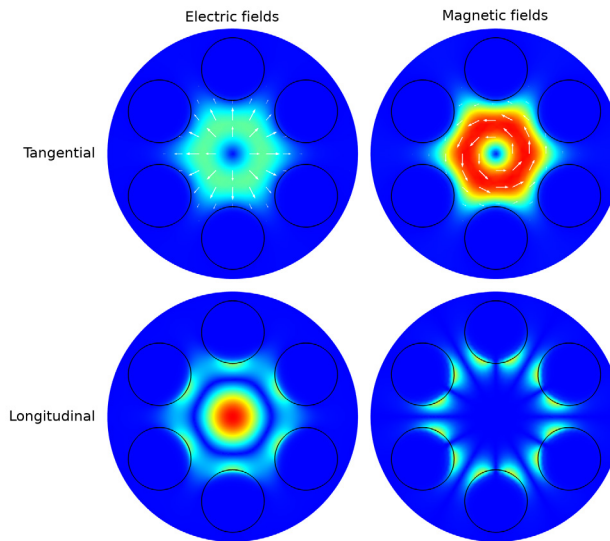

This is a TM_{01} -like mode, where the field is almost rotationally invariant and polarized in the radial direction. As seen, the longitudinal magnetic field is very small, whereas the longitudinal electric field is non-negligible.

II Click ← Plot Previous.

Effective mode index=1.4293 Tangential and longitudinal electric and magnetic fields

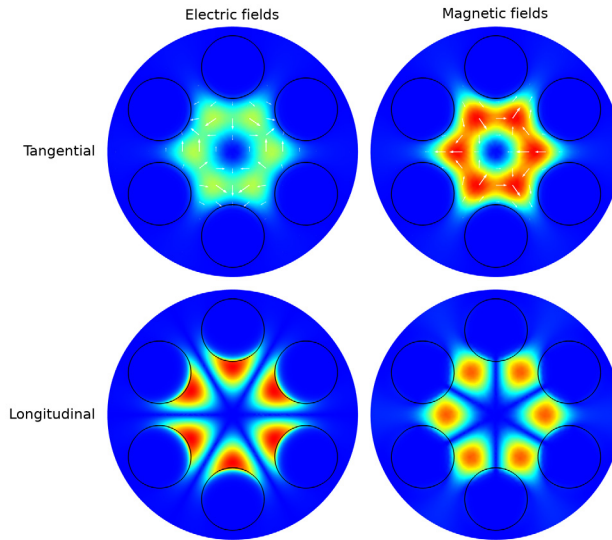

This is the first HE_{31} -like mode.

12 Click ← Plot Previous.

Effective mode index=1.4299 Tangential and longitudinal electric and magnetic fields

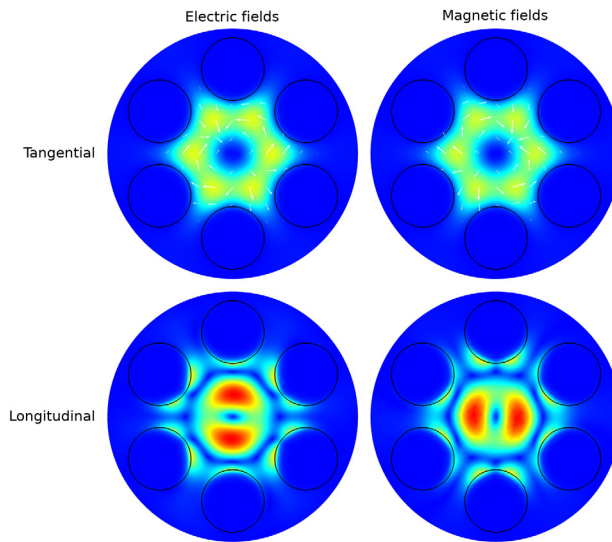

This is the first degenerate EH_{11} -like mode.

13 Click  Plot Previous.

Effective mode index=1.43 Tangential and longitudinal electric and magnetic fields

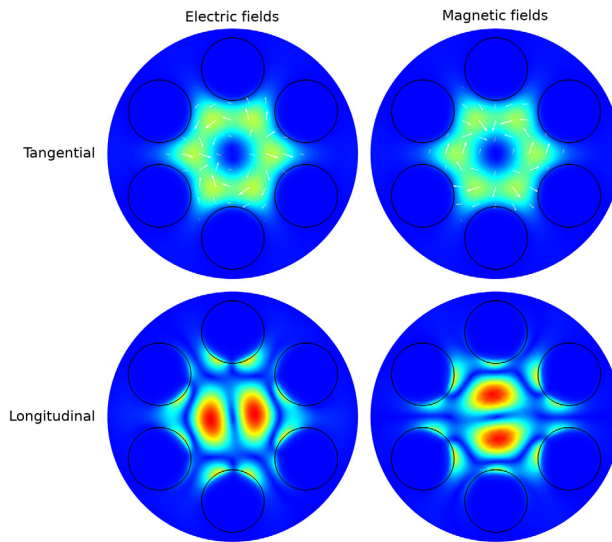

This is the second degenerate EH_{11} -like mode.

14 Click [← Plot Previous.](#)

Effective mode index=1.4304 Tangential and longitudinal electric and magnetic fields

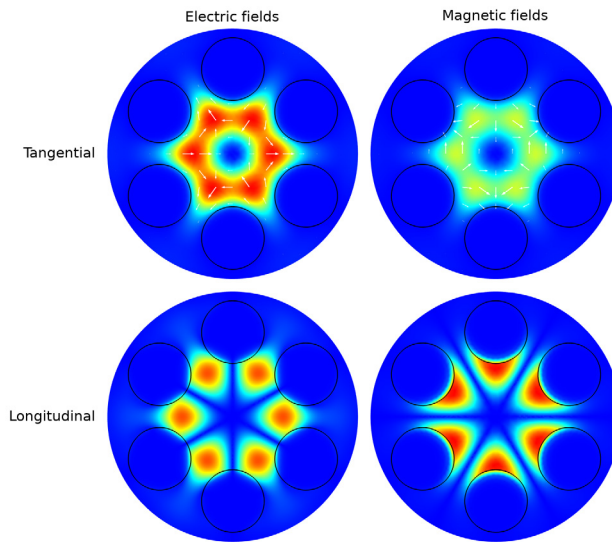

Finally, this is the second HE_{31} -like mode.