



Vivaldi Antenna

Introduction

A tapered slot antenna, also known as a Vivaldi antenna, is useful for wideband applications. Here, an exponential function is used for the taper profile. The objective of this example is to compute the far-field pattern and to compute the impedance of the structure. Good matching is observed over a wide frequency band.

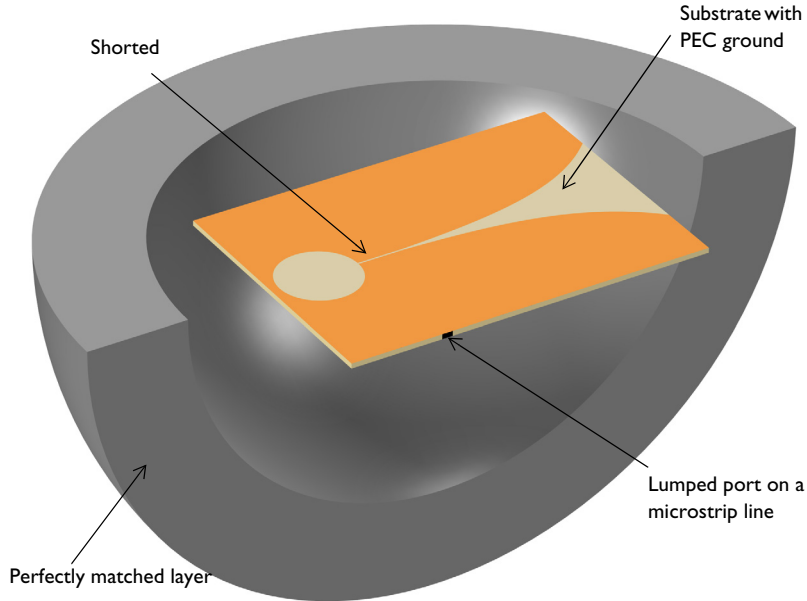

Figure 1: The Vivaldi antenna is realized on a thin dielectric substrate. The entire domain is bounded by a perfectly matched layer.

Model Definition

In this Vivaldi antenna model, the tapered slot is patterned with a perfect electric conductor (PEC) ground plane on the top of the dielectric substrate. A simple exponential function, $e^{0.044x}$ is used to create the tapered slot curves. One end of the slot is open to air and the other end is finished with a circular slot. On the bottom of the substrate, the shorted 50Ω microstrip feed line is modeled as PEC surfaces. The entire modeling domain is bounded by a perfectly matched layer (PML) which acts like an anechoic chamber absorbing all radiated energy. To excite the antenna, a lumped port is used. The model is meshed using a tetrahedral mesh with approximately five elements per wavelength in each material and simulation frequency.

Results and Discussion

The simulated SWR plot, [Figure 2](#), shows good wideband matching properties. A Vivaldi antenna utilizes traveling waves generating a directive radiation pattern toward the open end of the tapered slot. The 3D far-field pattern in [Figure 3](#) shows a directive radiation pattern.

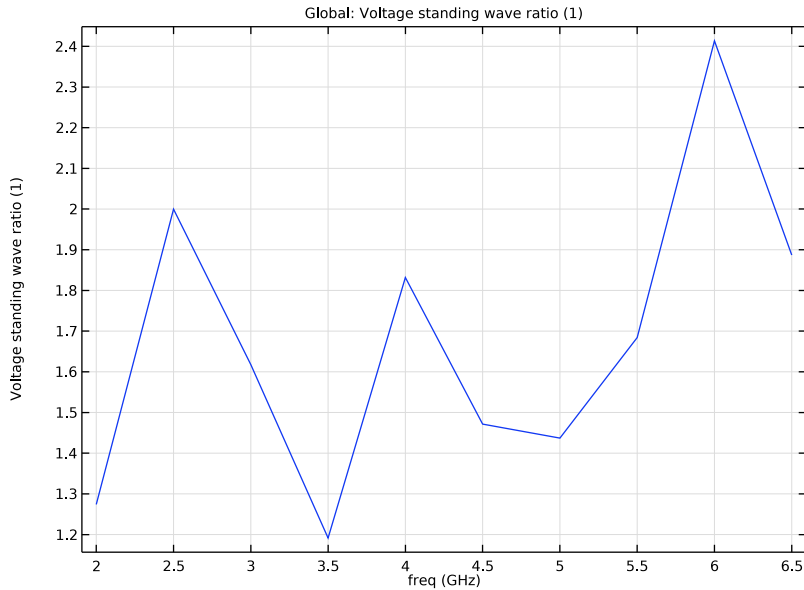

Figure 2: The frequency response SWR of the Vivaldi antenna shows wideband impedance matching, better than 2:1 in most of the simulated frequency range.

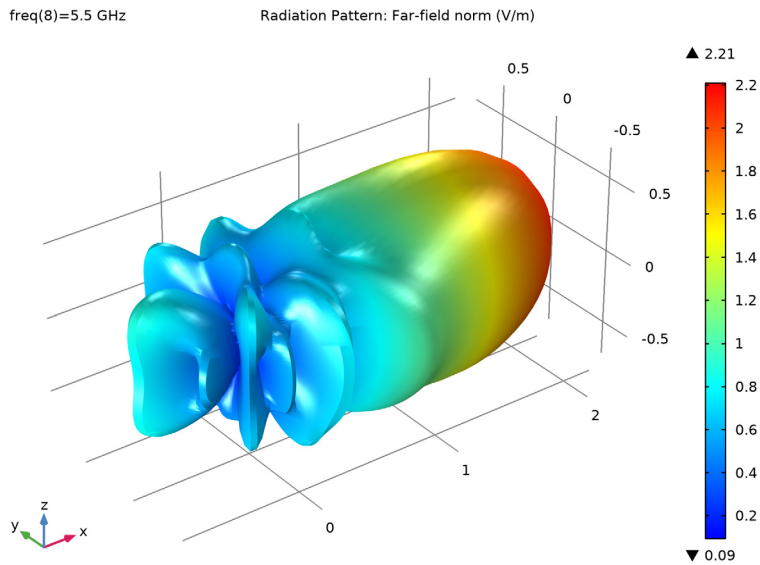



Figure 3: 3D far-field pattern at 5.5 GHz shows a directional radiation pattern.

Application Library path: RF_Module/Antennas/vivaldi_antenna

Modeling Instructions

From the **File** menu, choose **New**.

NEW

In the **New** window, click  **Model Wizard**.

MODEL WIZARD

- 1** In the **Model Wizard** window, click  **3D**.
- 2** In the **Select Physics** tree, select **Radio Frequency>Electromagnetic Waves, Frequency Domain (emw)**.
- 3** Click **Add**.

- 4 Click  **Study**.
- 5 In the **Select Study** tree, select **General Studies>Frequency Domain**.
- 6 Click  **Done**.

STUDY 1

Step 1: Frequency Domain

- 1 In the **Model Builder** window, under **Study 1** click **Step 1: Frequency Domain**.
- 2 In the **Settings** window for **Frequency Domain**, locate the **Study Settings** section.
- 3 In the **Frequencies** text field, type range(2[GHz], 0.5[GHz], 6.5[GHz]).

GEOMETRY 1

- 1 In the **Model Builder** window, under **Component 1 (comp1)** click **Geometry 1**.
- 2 In the **Settings** window for **Geometry**, locate the **Units** section.
- 3 From the **Length unit** list, choose **mm**.

GLOBAL DEFINITIONS

Parameters 1

- 1 In the **Model Builder** window, under **Global Definitions** click **Parameters 1**.
- 2 In the **Settings** window for **Parameters**, locate the **Parameters** section.
- 3 In the table, enter the following settings:

Name	Expression	Value	Description
thickness	60[mil]	0.001524 m	Substrate thickness
w_slot	0.5[mm]	5E-4 m	Slot with

Here, mil refers to the unit milliinch.

GEOMETRY 1

Create a block for the antenna substrate.

Substrate

- 1 In the **Geometry** toolbar, click  **Block**.
- 2 In the **Settings** window for **Block**, type Substrate in the **Label** text field.
- 3 Locate the **Size and Shape** section. In the **Width** text field, type 110.
- 4 In the **Depth** text field, type 80.
- 5 In the **Height** text field, type thickness.

6 Locate the **Position** section. From the **Base** list, choose **Center**.



Next, add a block for the 50Ω microstrip feed line.

Feed line

- 1 In the **Geometry** toolbar, click  **Block**.
- 2 In the **Settings** window for **Block**, type *Feed line* in the **Label** text field.
- 3 Locate the **Size and Shape** section. In the **Width** text field, type 3.2 .
- 4 In the **Depth** text field, type $40+w_slot/2$.
- 5 In the **Height** text field, type *thickness*.
- 6 Locate the **Position** section. From the **Base** list, choose **Center**.
- 7 In the **x** text field, type -26 .
- 8 In the **y** text field, type $-20+w_slot/4$.

Next, create a work plane where you will draw the Vivaldi antenna pattern. Use two parametric curves for the tapered slot.

Work Plane 1 (wp1)

- 1 In the **Geometry** toolbar, click  **Work Plane**.
- 2 In the **Settings** window for **Work Plane**, locate the **Plane Definition** section.
- 3 In the **z-coordinate** text field, type $thickness/2$.
- 4 Click  **Show Work Plane**.

Work Plane 1 (wp1)>Plane Geometry

Click the  **Zoom Extents** button in the **Graphics** toolbar.

Add a parametric curve using the exponential profile.

Work Plane 1 (wp1)>Parametric Curve 1 (pc1)

- 1 In the **Work Plane** toolbar, click  **More Primitives** and choose **Parametric Curve**.
- 2 In the **Settings** window for **Parametric Curve**, locate the **Parameter** section.
- 3 In the **Maximum** text field, type 70 .
- 4 Locate the **Expressions** section. In the **xw** text field, type $s-15$.
- 5 In the **yw** text field, type $\exp(0.044*s) - 1 + w_slot/2$.

Generate the other parametric curve by mirroring the first one.

Work Plane 1 (wp1)>Mirror 1 (mir1)

- 1 In the **Work Plane** toolbar, click  **Transforms** and choose **Mirror**.

- 2 In the **Settings** window for **Mirror**, locate the **Normal Vector to Line of Reflection** section.
- 3 In the **yw** text field, type 1.
- 4 In the **xw** text field, type 0.
- 5 Locate the **Input** section. Select the **Keep input objects** check box.
- 6 Select the object **pcl** only.
- 7 Click  **Build Selected**.

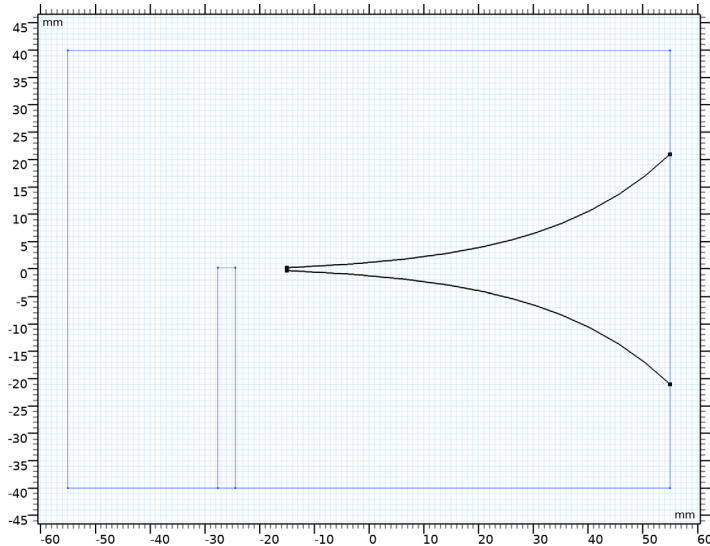

Add a rectangle describing the thin slot connected to the tapered slot.

Work Plane 1 (wp1)>Rectangle 1 (r1)

- 1 In the **Work Plane** toolbar, click  **Rectangle**.
- 2 In the **Settings** window for **Rectangle**, locate the **Size and Shape** section.
- 3 In the **Width** text field, type 20.
- 4 In the **Height** text field, type w_{slot} .
- 5 Locate the **Position** section. In the **xw** text field, type -35.
- 6 In the **yw** text field, type $-w_{slot}/2$.

Add a circle attached to the end of the slot.



Work Plane 1 (wp1)>Circle 1 (c1)

- 1 In the **Work Plane** toolbar, click  **Circle**.
- 2 In the **Settings** window for **Circle**, locate the **Size and Shape** section.

- 3 In the **Radius** text field, type 12.
- 4 Locate the **Position** section. In the **xw** text field, type -40.5.

Create a union of the circle and the rectangle to remove unnecessary boundaries.

Work Plane 1 (wp1)>Union 1 (uni1)

- 1 In the **Work Plane** toolbar, click  **Booleans and Partitions** and choose **Union**.
- 2 Select the objects **c1** and **r1** only.
- 3 In the **Settings** window for **Union**, locate the **Union** section.
- 4 Clear the **Keep interior boundaries** check box.
- 5 In the **Work Plane** toolbar, click  **Build All**.

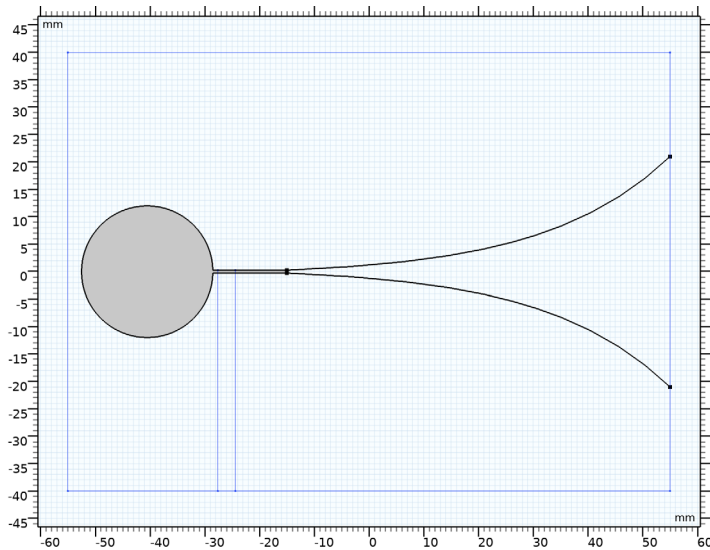

Add a sphere for the PMLs. Use a layer definition to create a shell-type structure.

PML

- 1 In the **Model Builder** window, right-click **Geometry 1** and choose **Sphere**.
- 2 In the **Settings** window for **Sphere**, type PML in the **Label** text field.
- 3 Locate the **Size** section. In the **Radius** text field, type 110.
- 4 Click to expand the **Layers** section. In the table, enter the following settings:

Layer name	Thickness (mm)
Layer 1	30

5 Click  **Build All Objects**.

6 Click the  **Zoom Extents** button in the **Graphics** toolbar.

Choose wireframe rendering to get a better view of the interior parts.

7 Click the  **Wireframe Rendering** button in the **Graphics** toolbar.

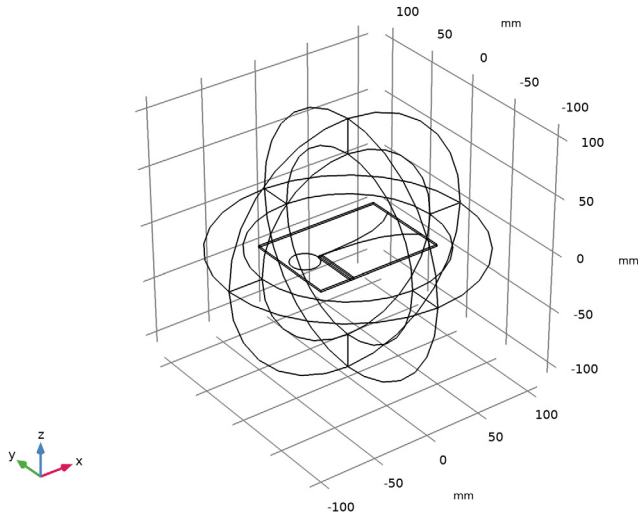

DEFINITIONS

Add a perfectly matched layer.

Perfectly Matched Layer 1 (pml1)

1 In the **Definitions** toolbar, click  **Perfectly Matched Layer**.

2 Select Domains 1–4 and 8–11 only.

3 In the **Settings** window for **Perfectly Matched Layer**, locate the **Geometry** section.

4 From the **Type** list, choose **Spherical**.

View 1

Hide some domains to get a better view of the interior parts when setting up the physics and reviewing the mesh.

Hide for Physics 1

1 In the **Model Builder** window, right-click **View 1** and choose **Hide for Physics**.

2 Select Domains 2 and 9 only.

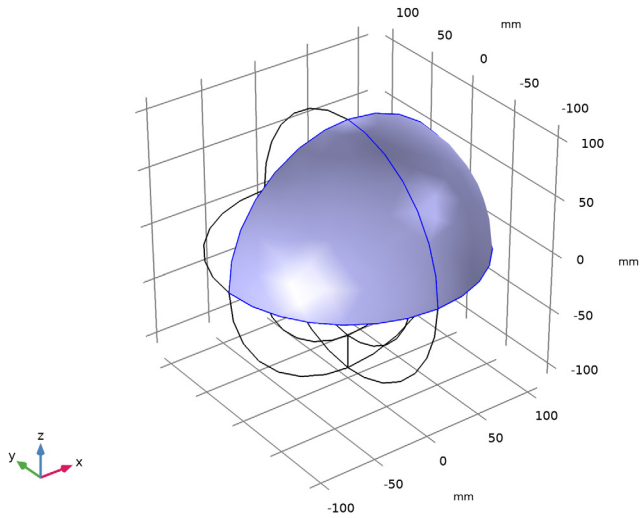

Hide for Physics 2

- 1 Right-click **View 1** and choose **Hide for Physics**.
- 2 In the **Settings** window for **Hide for Physics**, locate the **Geometric Entity Selection** section.
- 3 From the **Geometric entity level** list, choose **Boundary**.

4 Select Boundaries 10 and 36 only.

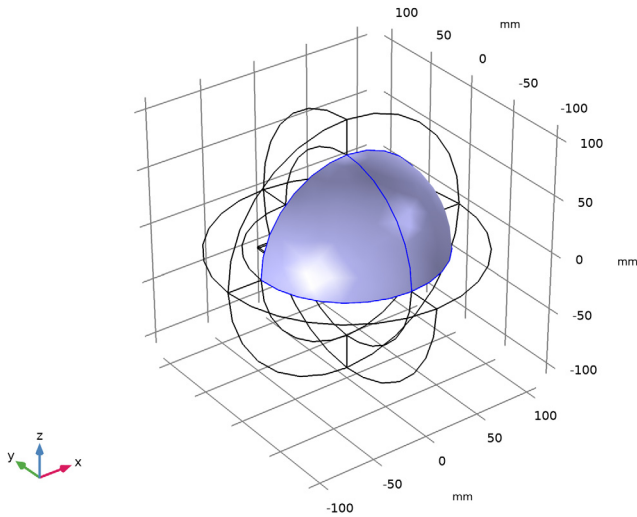

ELECTROMAGNETIC WAVES, FREQUENCY DOMAIN (EMW)

Now set up the physics. Use the selections already defined when assigning boundary conditions.



Perfect Electric Conductor 2

- 1 In the **Model Builder** window, under **Component 1 (comp1)** right-click **Electromagnetic Waves, Frequency Domain (emw)** and choose **Perfect Electric Conductor**.
- 2 Select Boundaries 16, 21, 22, 24, and 27 only.

Far-Field Domain 1

In the **Physics** toolbar, click  **Domains** and choose **Far-Field Domain**.

Lumped Port 1

- 1 In the **Physics** toolbar, click  **Boundaries** and choose **Lumped Port**.
- 2 Click the  **Zoom In** button in the **Graphics** toolbar, a couple of times to get a better view.

3 Select Boundary 20 only.

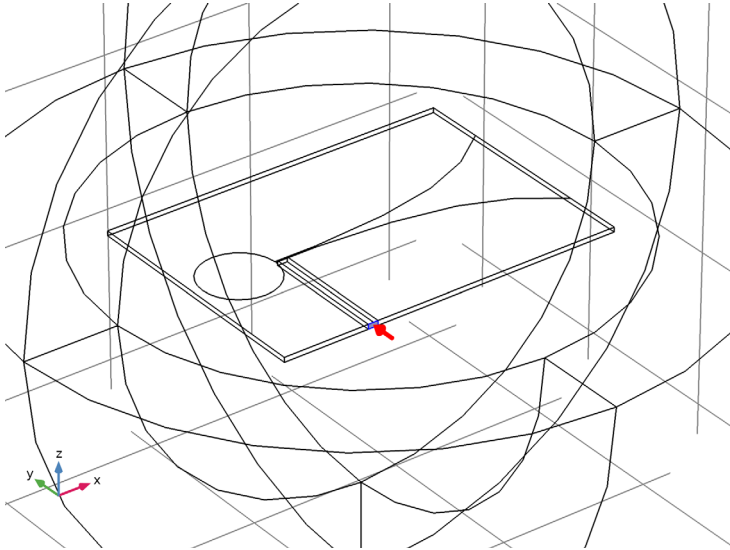



For the first port, wave excitation is **on** by default.

MATERIALS

Assign material properties for the model. First, use air for all domains.

ADD MATERIAL

- 1 In the **Home** toolbar, click  **Add Material** to open the **Add Material** window.
- 2 Go to the **Add Material** window.
- 3 In the tree, select **Built-in>Air**.
- 4 Click **Add to Component** in the window toolbar.
- 5 In the **Home** toolbar, click  **Add Material** to close the **Add Material** window.

MATERIALS

Air (mat1)

Override the substrate with a dielectric material of $\epsilon_r = 3.38$.

Substrate

- 1 In the **Model Builder** window, right-click **Materials** and choose **Blank Material**.
- 2 In the **Settings** window for **Material**, type **Substrate** in the **Label** text field.
- 3 Select Domains 6 and 7 only.

4 Locate the **Material Contents** section. In the table, enter the following settings:

Property	Variable	Value	Unit	Property group
Relative permittivity	epsilon _{nr_} iso ; epsilon _{nrii} = epsilon _{nr_} iso, epsilon _{nrij} = 0	3.38		Basic
Relative permeability	mu _{r_} iso ; mu _{rii} = mu _{r_} iso, mu _{rij} = 0	1		Basic
Electrical conductivity	sigma _{iso} ; sigma _{ii} = sigma _{iso} , sigma _{ij} = 0	0	S/m	Basic

MESH 1

- 1 In the **Model Builder** window, under **Component 1 (comp1)** click **Mesh 1**.
- 2 In the **Settings** window for **Mesh**, locate the **Physics-Controlled Mesh** section.
- 3 From the **Element size** list, choose **Coarse**.
- 4 Click  **Build All**.

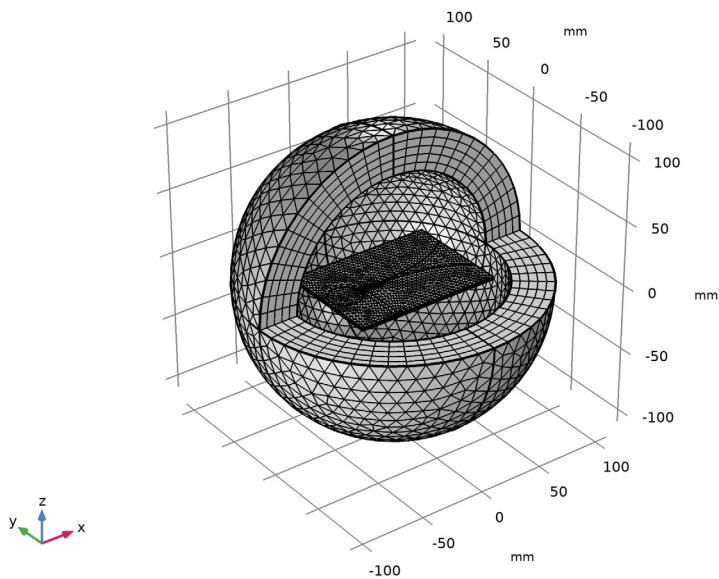

STUDY 1

In the **Home** toolbar, click  **Compute**.

RESULTS

Multislice

- 1** In the **Model Builder** window, expand the **Results>Electric Field (emw)** node, then click **Multislice**.
- 2** In the **Settings** window for **Multislice**, locate the **Expression** section.
- 3** In the **Expression** text field, type $emw.Ey$.
- 4** Locate the **Multipane Data** section. Find the **X-planes** subsection. In the **Planes** text field, type 0.
- 5** Find the **Y-planes** subsection. In the **Planes** text field, type 0.
- 6** Find the **Z-planes** subsection. From the **Entry method** list, choose **Coordinates**.
- 7** In the **Coordinates** text field, type $thickness/2$.
- 8** Click to expand the **Range** section. Select the **Manual color range** check box.
- 9** In the **Minimum** text field, type -400.
- 10** In the **Maximum** text field, type 400.
- 11** Locate the **Coloring and Style** section. From the **Color table** list, choose **Wave**.

Selection 1

- 1** Right-click **Multislice** and choose **Selection**.
- 2** Select Domain 5 only.

3 In the **Electric Field (emw)** toolbar, click  **Plot**.

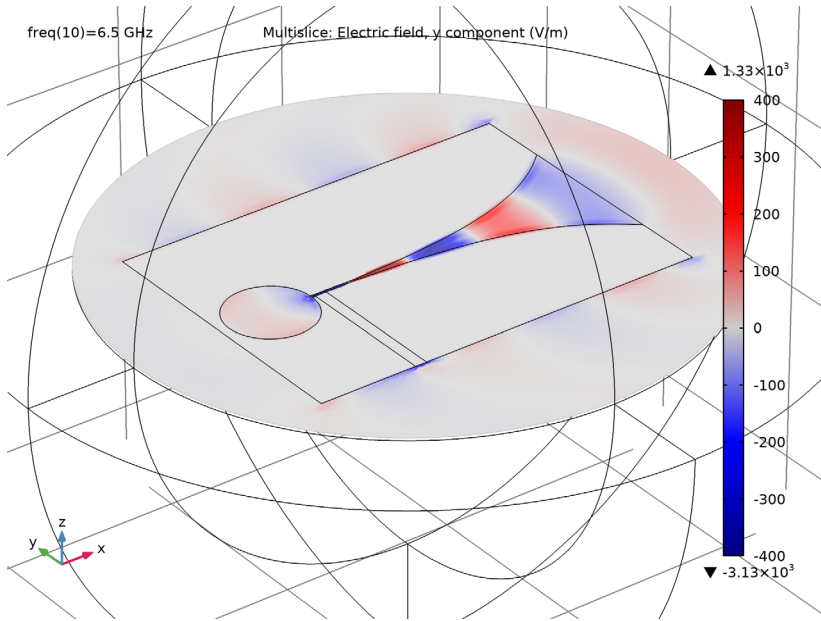

Electric fields are guided along the tapered slot.

S-parameter (emw)

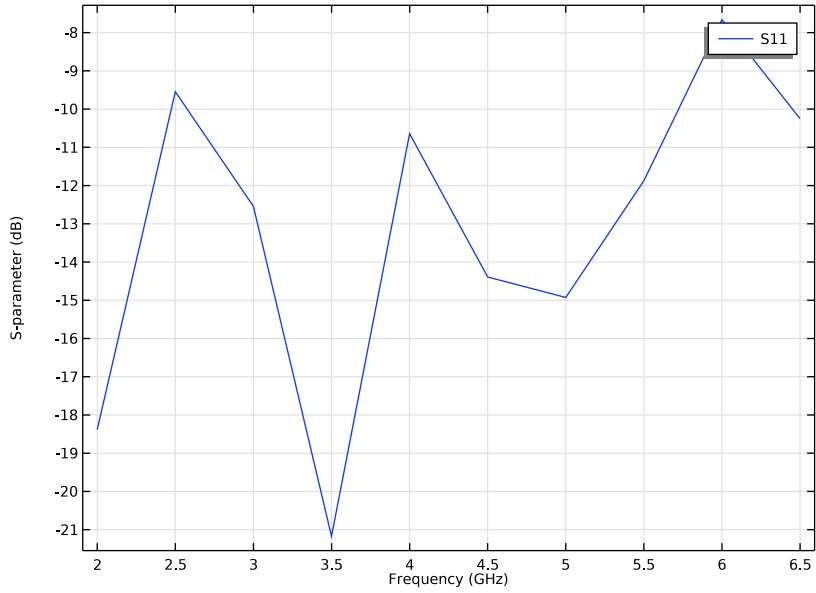

Smith Plot (emw)

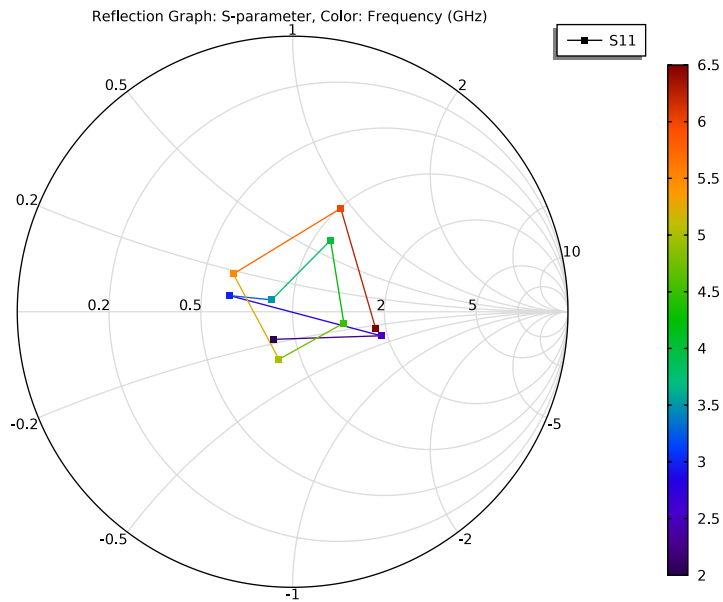

Radiation Pattern I

- 1 In the **Model Builder** window, expand the **Results>2D Far Field (emw)** node, then click **Radiation Pattern I**.
- 2 In the **Settings** window for **Radiation Pattern**, locate the **Evaluation** section.
- 3 Find the **Angles** subsection. In the **Number of angles** text field, type 100.
- 4 In the **2D Far Field (emw)** toolbar, click  **Plot**.

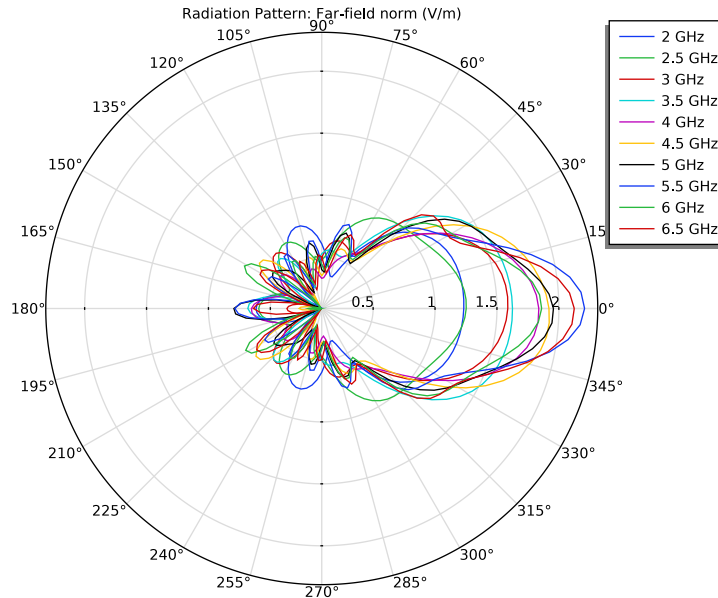

2D far-field radiation patterns in the $/[xy]/$ -plane plotted for all frequencies.

3D Far Field (emw)

- 1 In the **Model Builder** window, click **3D Far Field (emw)**.
- 2 In the **Settings** window for **3D Plot Group**, locate the **Data** section.
- 3 From the **Parameter value (freq (GHz))** list, choose **5.5**.

Radiation Pattern I

- 1 In the **Model Builder** window, expand the **3D Far Field (emw)** node, then click **Radiation Pattern I**.
- 2 In the **Settings** window for **Radiation Pattern**, locate the **Evaluation** section.
- 3 Find the **Angles** subsection. In the **Number of elevation angles** text field, type 90.
- 4 In the **Number of azimuth angles** text field, type 90.

5 In the **3D Far Field (emw)** toolbar, click  **Plot**.

TABLE

1 Go to the **Table** window.

Compare the resulting 3D radiation pattern plot with [Figure 3](#).

RESULTS

ID Plot Group 6

In the **Home** toolbar, click  **Add Plot Group** and choose **ID Plot Group**.

Global 1

1 Right-click **ID Plot Group 6** and choose **Global**.

2 In the **Settings** window for **Global**, click **Add Expression** in the upper-right corner of the **y-Axis Data** section. From the menu, choose **Component 1 (comp1)> Electromagnetic Waves, Frequency Domain>Ports>emw.VSWR_1 - Voltage standing wave ratio**.

3 Click to expand the **Legends** section. Clear the **Show legends** check box.

4 In the **ID Plot Group 6** toolbar, click  **Plot**.

This VSWR plot replicates the wideband frequency response shown in [Figure 2](#).

3D Plot Group 7

In the **Home** toolbar, click  **Add Plot Group** and choose **3D Plot Group**.

Isosurface 1

1 Right-click **3D Plot Group 7** and choose **Isosurface**.

2 In the **Settings** window for **Isosurface**, locate the **Expression** section.

3 In the **Expression** text field, type $20 * \log_{10}(\text{emw}.\text{normE} + 0.1)$.

4 Locate the **Levels** section. In the **Total levels** text field, type 20.

Selection 1

1 Right-click **Isosurface 1** and choose **Selection**.

2 Select Domains 5 and 6 only.

Filter 1

1 In the **Model Builder** window, right-click **Isosurface 1** and choose **Filter**.

2 In the **Settings** window for **Filter**, locate the **Element Selection** section.

3 In the **Logical expression for inclusion** text field, type $y > 0 \ \&\& \ z < 0$.

4 In the **3D Plot Group 7** toolbar, click  **Plot**.

