



Specific Absorption Rate (SAR) in the Human Brain

Introduction

Scientists use the SAR (specific absorption rate) to determine the amount of radiation that human tissue absorbs. This measurement is especially important for mobile telephones, which radiate close to the brain. The model studies how a human head absorbs a radiated wave from an antenna and the temperature increase that the absorbed radiation causes.

Note: This example requires the RF Module and the Heat Transfer Module.

The increasing use of wireless equipment has also increased the amount of radiation energy to which human bodies are exposed, and it is particularly important to avoid radiation into the brain. Experts continue to debate how dangerous this radiation might be. Almost everyone agrees, however, that it is important to minimize exposure to radiation. A common property that measures absorbed energy is the SAR value, calculated as

$$E_{\text{SAR}} = \sigma \frac{|\mathbf{E}|^2}{\rho}$$

where σ is the conductivity of human brain tissue, ρ is the density, and $|\mathbf{E}|$ is the norm of the electric field (RMS). The SAR value is an average over a region of either 10 g or 1 g of brain tissue, depending on national rules. This example does not calculate the average value and so it refers to the local SAR value. The maximum local SAR value is always higher than the maximum SAR value.

Model Definition

The human head geometry is the same geometry (SAM Phantom) provided by IEEE, IEC, and CENELEC from their standard specification of SAR value measurements. The original geometry was imported into COMSOL Multiphysics after minor adjustments of the original geometry.

In addition, the model samples some material parameters with a volumetric interpolation function that estimates the variation of tissue type inside the head. The source data for this function comes directly from a file named `sar_in_human_head_interp.txt`. That data file was created from a magnetic-resonance image (MRI) of a human head; these images contain 109 slices, each with 256-by-256 voxels (Ref. 2). The use of the variation of the data in this file on the tissue material parameters has no scientific background, and this example simply implements it to illustrate a variation in conductivity, permittivity (Figure

1), and perfusion rate as a function of the position inside the head. The model reduces the resolution of the volumetric data to 55-by-50-by-50 interpolation points, which matches the mesh-element density inside the head. Prior to generating the data file, the modeler in this case scaled, translated, and rotated the 3D MRI data to match the form of the imported head geometry in COMSOL Multiphysics.

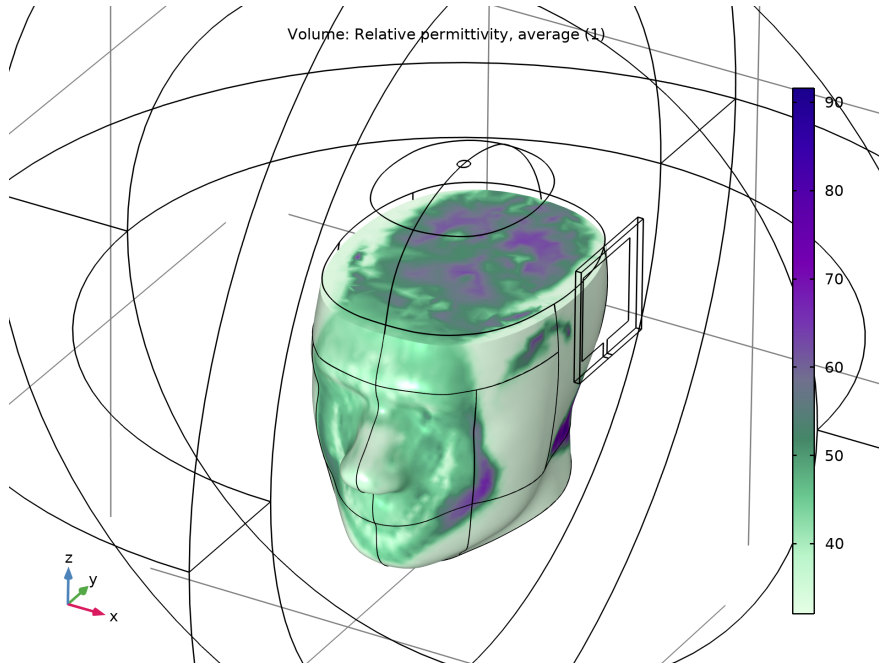

Figure 1: This plot shows how the average relative permittivity varies inside the head. The permittivity is calculated from the imported MRI image data.

WAVE PROPAGATION

The radiation comes from a patch antenna placed on the left side of the head. The patch antenna is excited by a lumped port. To absorb the scattered radiation, the model makes use of a PML; see the section *Perfectly Matched Layer* in the *COMSOL Multiphysics Reference Manual* for details. The model solves the vector-Helmholtz equation everywhere in the domain for a certain frequency

$$\nabla \times \frac{1}{\mu_r} \nabla \times \mathbf{E} - k_0^2 \epsilon_r \mathbf{E} = \mathbf{0}$$

where μ_r is the relative permeability, k_0 is the free-space wave vector, and ϵ_r is the permittivity.

For wave-propagation problems such as this one, you must limit the mesh size according to the problem's minimum wavelength. Typically you need about five elements per wavelength to properly resolve the wave.

This example takes material properties for the human brain from a presentation by G. Schmid (Ref. 1). The following table reviews some important frequency-dependent properties in this publication. The interpolation function samples these values to create a realistic variation.

PARAMETER	FREQUENCY	VALUE	DESCRIPTION
σ	835 MHz	1.15 S/m	Conductivity
ϵ_r	835 MHz	58.13	Relative permittivity

HEATING OF THE HEAD

The bioheat equation models the heating of the head with a heating loss due to the blood flow. This heat loss depends on the heat capacity and density of the blood, and on the blood perfusion rate. The perfusion rate varies significantly in different parts of the human body, and the table below presents the values used here.

PART	PERFUSION RATE
Brain	$2 \cdot 10^{-3}$ (ml/s)/ml
Bone	$3 \cdot 10^{-4}$ (ml/s)/ml
Skin	$3 \cdot 10^{-4}$ (ml/s)/ml

The same interpolation function used for the electric parameters also models the difference in perfusion rate between the brain tissue inside the head and the outer parts of skin and

bone. Note again that the use of the interpolation function does not have any physical relevance; it is just to show a realistic effect of a varying material parameter.

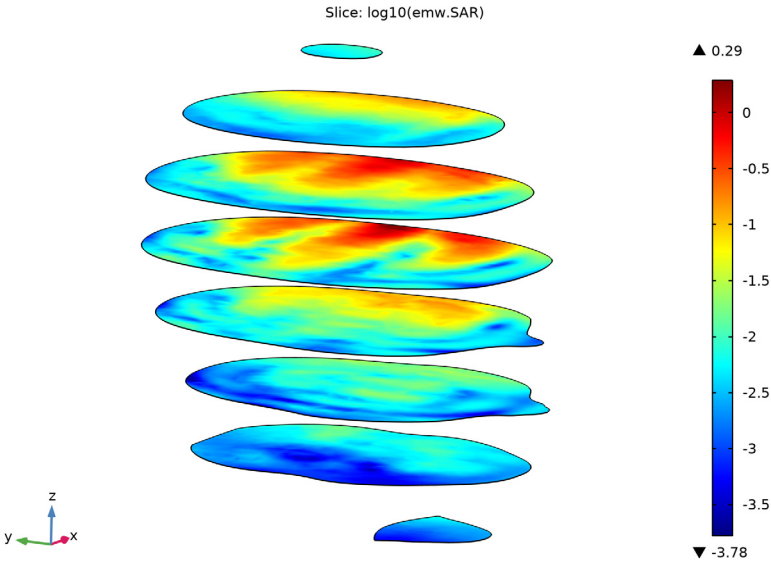

Figure 2: Log-scale slice plot of the local SAR value.

Results and Discussion

The model studies the local SAR value in the head using the formula described earlier for the frequency 835 MHz. The SAR value is highest close to the surface of the head facing the incident wave. The differences in electrical properties become visible if you plot the local SAR value on a log scale (Figure 1).

The bioheat equation produces a similar plot for the heating of the head, which is highest closest to the antenna. The maximum temperature increase (from 37°C) is about 0.15°C, and drops rapidly inside the head.

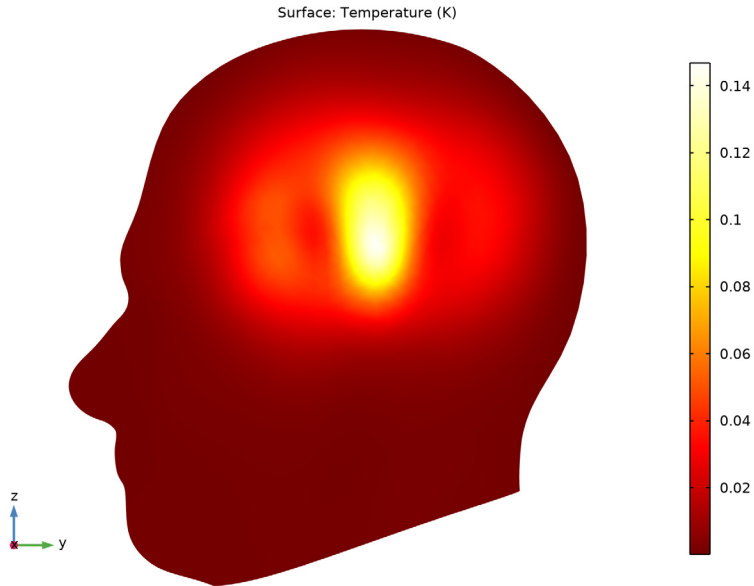

Figure 3: The local increase in temperature at the surface has the maximum right beneath the antenna.

References

1. G. Schmid, G. Neubauer, and P.R. Mazal, “Dielectric properties of human brain tissue measured less than 10 h postmortem at frequencies from 800 to 2450 MHz,” *Bioelectromagnetics*, vol. 24, pp 423–430, 2003.
2. M. Levoy, MRI data originally from Univ. of North Carolina (downloaded from the Stanford volume data archive at <http://graphics.stanford.edu/data/voldata/>).

Application Library path: RF_Module/Microwave_Heating/sar_in_human_head

Modeling Instructions

From the **File** menu, choose **New**.

NEW

In the **New** window, click  **Model Wizard**.

MODEL WIZARD

- 1 In the **Model Wizard** window, click  **3D**.
- 2 In the **Select Physics** tree, select **Heat Transfer>Bioheat Transfer (ht)**.
- 3 Click **Add**.
- 4 In the **Temperature** text field, type **dT**.
- 5 In the **Select Physics** tree, select **Radio Frequency>Electromagnetic Waves, Frequency Domain (emw)**.
- 6 Click **Add**.

Wait adding the study until the multiphysics coupling has been added. Then the study sequence will be automatically configured for the right interfaces.

- 7 Click  **Done**.

GLOBAL DEFINITIONS

Parameters 1

- 1 In the **Model Builder** window, under **Global Definitions** click **Parameters 1**.
- 2 In the **Settings** window for **Parameters**, locate the **Parameters** section.
- 3 In the table, enter the following settings:

Name	Expression	Value	Description
epsilon_r_pcb	5.23	5.23	Permittivity for the patch antenna board
epsilon_r0_brain	58.13	58.13	Permittivity for the brain tissue
sigma0_brain	1.15[S/m]	1.15 S/m	Conductivity for the brain tissue
rho_brain	1.03e3[kg/m^3]	1030 kg/m ³	Density of brain tissue
sdamping	2e-4	2E-4	Sampling parameter
edamping	4e-4	4E-4	Sampling parameter
soffset	-1.0[S/m]	-1 S/m	Sampling parameter

Name	Expression	Value	Description
eoffset	-50	-50	Sampling parameter
c_blood	3639[J/(kg*K)]	3639 J/(kg·K)	Heat capacity of blood
rho_blood	1000[kg/m^3]	1000 kg/m ³	Density of blood
odamping	1.08e-6[1/s]	1.08E-6 1/s	Sampling parameter
ooffset	7.8e-4[1/s]	7.8E-4 1/s	Sampling parameter
f0	835[MHz]	8.35E8 Hz	Frequency



GEOMETRY I

The head geometry has been created outside COMSOL Multiphysics, so you import it from an MPHBIN-file. Then create the surrounding domains of PML, air, and antenna manually.

Import 1 (imp1)

- 1 In the **Home** toolbar, click  **Import**.
- 2 In the **Settings** window for **Import**, locate the **Import** section.
- 3 Click **Browse**.
- 4 Browse to the model's Application Libraries folder and double-click the file sar_in_human_head.mphbin.
- 5 Click **Import**.

Block 1 (blk1)

- 1 In the **Geometry** toolbar, click  **Block**.
- 2 In the **Settings** window for **Block**, locate the **Size and Shape** section.
- 3 In the **Width** text field, type 0.004.
- 4 In the **Depth** text field, type 0.08.
- 5 In the **Height** text field, type 0.08.
- 6 Locate the **Position** section. From the **Base** list, choose **Center**.
- 7 In the **x** text field, type 0.1.
- 8 In the **z** text field, type 0.05.
- 9 Click  **Build All Objects**.

Work Plane 1 (wp1)

- 1 In the **Geometry** toolbar, click  **Work Plane**.
- 2 In the **Settings** window for **Work Plane**, locate the **Plane Definition** section.
- 3 From the **Plane** list, choose **yz-plane**.

4 In the **x-coordinate** text field, type 0.098.

5 Click  **Show Work Plane**.

Work Plane 1 (wp1)>Square 1 (sq1)

1 In the **Work Plane** toolbar, click  **Square**.

2 In the **Settings** window for **Square**, locate the **Size** section.

3 In the **Side length** text field, type 0.06.

4 Locate the **Position** section. From the **Base** list, choose **Center**.

5 In the **yw** text field, type 0.05.

6 Click  **Build Selected**.

Work Plane 1 (wp1)>Rectangle 1 (r1)

1 In the **Work Plane** toolbar, click  **Rectangle**.

2 In the **Settings** window for **Rectangle**, locate the **Size and Shape** section.

3 In the **Width** text field, type 0.005.

4 In the **Height** text field, type 0.01.

5 Locate the **Position** section. From the **Base** list, choose **Center**.

6 In the **yw** text field, type 0.015.

7 Click  **Build Selected**.

Work Plane 1 (wp1)>Union 1 (uni1)

1 In the **Work Plane** toolbar, click  **Booleans and Partitions** and choose **Union**.

2 Click in the **Graphics** window and then press Ctrl+A to select both objects.

3 In the **Settings** window for **Union**, locate the **Union** section.

4 Clear the **Keep interior boundaries** check box.

5 In the **Work Plane** toolbar, click  **Build All**.

Work Plane 2 (wp2)

1 In the **Model Builder** window, right-click **Geometry 1** and choose **Work Plane**.

2 In the **Settings** window for **Work Plane**, locate the **Plane Definition** section.

3 In the **z-coordinate** text field, type 0.01.

4 Click  **Show Work Plane**.

Work Plane 2 (wp2)>Rectangle 1 (r1)

1 In the **Work Plane** toolbar, click  **Rectangle**.

2 In the **Settings** window for **Rectangle**, locate the **Position** section.

- 3 From the **Base** list, choose **Center**.
- 4 In the **xw** text field, type 0.1.
- 5 Locate the **Size and Shape** section. In the **Width** text field, type 0.004.
- 6 In the **Height** text field, type 0.005.
- 7 Click  **Build Selected**.

Form Union (fin)

- 1 In the **Home** toolbar, click  **Build All**.

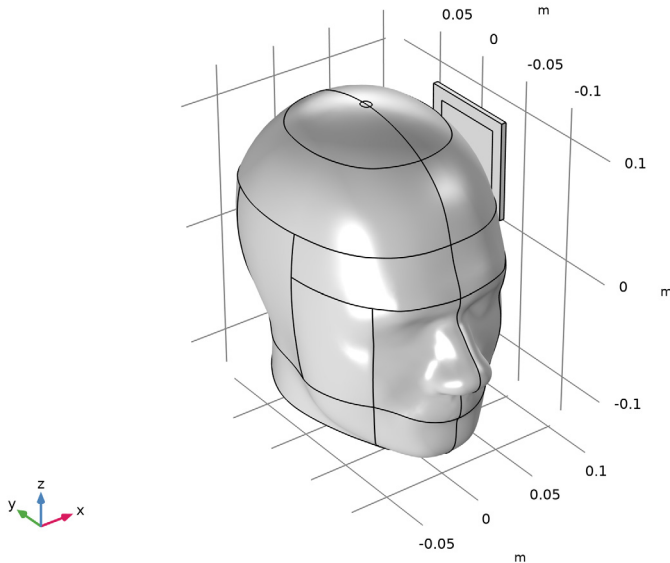

You have now created the patch antenna close to the head. Continue with the surrounding air and the PML regions.



Sphere 1 (sph1)

- 1 Right-click **Geometry 1** and choose **Sphere**.
- 2 In the **Settings** window for **Sphere**, locate the **Size** section.
- 3 In the **Radius** text field, type 0.35.
- 4 Click to expand the **Layers** section. In the table, enter the following settings:

Layer name	Thickness (m)
Layer 1	0.1

- 5 Click  **Build All Objects**.
- 6 Click the  **Zoom Extents** button in the **Graphics** toolbar.
- 7 Click the  **Transparency** button in the **Graphics** toolbar.

Form Union (fin)

- 1 In the **Model Builder** window, click **Form Union (fin)**.
- 2 In the **Settings** window for **Form Union/Assembly**, locate the **Form Union/Assembly** section.
- 3 From the **Repair tolerance** list, choose **Relative**.
- 4 In the **Relative repair tolerance** text field, type 1E-5.

This completes the model geometry.

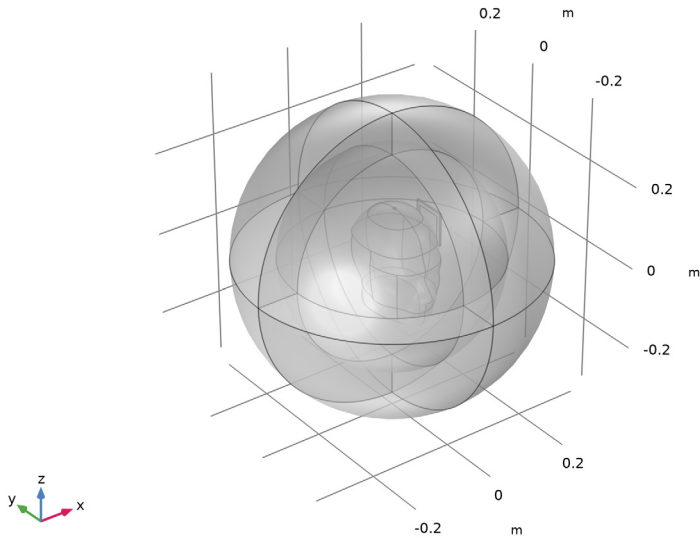

DEFINITIONS



To get a better view, you can use the mouse to rotate the plot. Furthermore, by assigning the resulting settings to a View node, you can easily return to the same view later.

View 4

- 1 In the **Model Builder** window, under **Component 1 (comp1)** right-click **Definitions** and choose **View**.
- 2 In the **Settings** window for **View**, click to expand the **Transparency** section.

- 3 Select the **Transparency** check box.
Rotate the geometry to get a good view.
- 4 In the **Model Builder** window, click **View 4**.
- 5 Locate the **View** section. Select the **Lock camera** check box.
This action locks the camera settings you just applied for this View node. Suppress some of the boundaries to simplify the domain selection.

Hide for Physics 1

- 1 Right-click **View 4** and choose **Hide for Physics**.
- 2 Click the  **Show Entities in Selection** button in the **Graphics** toolbar.
- 3 Select Domains 5, 7, and 8 only.
To return to this view after rotating, translating, or zooming the geometry in the **Graphics** window, click the **Go to View 4** button in the **Graphics** toolbar.
- 4 Click the  **Transparency** button in the **Graphics** toolbar.

Create the selections to simplify the model specification.

PML

- 1 In the **Definitions** toolbar, click  **Explicit**.
- 2 In the **Settings** window for **Explicit**, type PML in the **Label** text field.
- 3 Click the **Go to View 1** button in the **Graphics** toolbar.
- 4 Select Domains 1–4 and 7–10 only.

Head

- 1 In the **Definitions** toolbar, click  **Explicit**.
- 2 In the **Settings** window for **Explicit**, type Head in the **Label** text field.
- 3 Click the **Go to View 4** button in the **Graphics** toolbar.
- 4 Select Domain 6 only.

PCB

- 1 In the **Definitions** toolbar, click  **Explicit**.
- 2 In the **Settings** window for **Explicit**, type PCB in the **Label** text field.
- 3 Select Domain 11 only.

Interpolation 1 (int1)

- 1 In the **Definitions** toolbar, click  **Interpolation**.
- 2 In the **Settings** window for **Interpolation**, locate the **Definition** section.

- 3 From the **Data source** list, choose **File**.
- 4 Click **Browse**.
- 5 Browse to the model's Application Libraries folder and double-click the file sar_in_human_head_interp.txt.
- 6 Click **Import**.
- 7 Find the **Functions** subsection. In the table, enter the following settings:

Function name	Position in file
fbrain	1

Variables I

- 1 In the **Definitions** toolbar, click α = **Local Variables**.
- 2 In the **Settings** window for **Variables**, locate the **Geometric Entity Selection** section.
- 3 From the **Geometric entity level** list, choose **Domain**.
- 4 From the **Selection** list, choose **Head**.
- 5 Locate the **Variables** section. In the table, enter the following settings:

Name	Expression	Unit	Description
epsilon_r_brain	$\epsilon_{\text{brain}}(1 + f_{\text{brain}}(x[1/m], y[1/m], z[1/m]) * e_{\text{damping}}) + e_{\text{offset}}$		Relative permittivity of the brain
sigma_brain	$\sigma_{\text{brain}}(1 + f_{\text{brain}}(x[1/m], y[1/m], z[1/m]) * s_{\text{damping}}) + s_{\text{offset}}$	S/m	Conductivity of the brain
omega_head	$\omega_{\text{head}} * f_{\text{brain}}(x[1/m], y[1/m], z[1/m]) + o_{\text{offset}}$	1/s	Blood perfusion rate

BIOHEAT TRANSFER (HT)

- 1 In the **Model Builder** window, under **Component 1 (comp1)** click **Bioheat Transfer (ht)**.
- 2 In the **Settings** window for **Bioheat Transfer**, locate the **Domain Selection** section.
- 3 From the **Selection** list, choose **Head**.

MATERIALS

Material 1 (mat1)

- 1 In the **Model Builder** window, under **Component 1 (comp1)** right-click **Materials** and choose **Blank Material**.
- 2 In the **Settings** window for **Material**, locate the **Geometric Entity Selection** section.
- 3 From the **Selection** list, choose **PCB**.
- 4 Locate the **Material Contents** section. In the table, enter the following settings:

Property	Variable	Value	Unit	Property group
Relative permittivity	epsilon _{nr_iso} ; epsilon _{nrii} = epsilon _{nr_iso} , epsilon _{nrij} = 0	epsilon _{nr_pcb}	1	Basic
Relative permeability	mu _{r_iso} ; mu _{rii} = mu _{r_iso} , mu _{rrij} = 0	1	1	Basic
Electrical conductivity	sigma _{iso} ; sigma _{ii} = sigma _{iso} , sigma _{ij} = 0	0	S/m	Basic



Material 2 (mat2)

- 1 Right-click **Materials** and choose **Blank Material**.
- 2 In the **Settings** window for **Material**, locate the **Geometric Entity Selection** section.
- 3 From the **Selection** list, choose **Head**.
- 4 Locate the **Material Contents** section. In the table, enter the following settings:

Property	Variable	Value	Unit	Property group
Thermal conductivity	k _{iso} ; k _{ii} = k _{iso} , k _{ij} = 0	0.5	W/(m·K)	Basic
Density	rho	1050	kg/m ³	Basic
Heat capacity at constant pressure	C _p	3700	J/(kg·K)	Basic
Relative permittivity	epsilon _{nr_iso} ; epsilon _{nrii} = epsilon _{nr_iso} , epsilon _{nrij} = 0	epsilon _{nr_brain}	1	Basic

Property	Variable	Value	Unit	Property group
Relative permeability	mur_iso ; murii = mur_iso, murij = 0	1		Basic
Electrical conductivity	sigma_iso ; sigmaii = sigma_iso, sigmaij = 0	sigma_brain	S/m	Basic

ADD MATERIAL

- 1 In the **Home** toolbar, click  **Add Material** to open the **Add Material** window.
- 2 Go to the **Add Material** window.
- 3 In the tree, select **Built-in>Air**.
- 4 Click **Add to Component** in the window toolbar.
- 5 In the **Home** toolbar, click  **Add Material** to close the **Add Material** window.

MATERIALS

Air (mat3)

Select Domains 1–5 and 7–10 only.

BIOHEAT TRANSFER (HT)

Bioheat 1

- 1 In the **Model Builder** window, under **Component 1 (comp1)>Bioheat Transfer (ht)>Biological Tissue 1** click **Bioheat 1**.
- 2 In the **Settings** window for **Bioheat**, locate the **Bioheat** section.
- 3 In the ρ_b text field, type rho_blood.
- 4 In the $C_{p,b}$ text field, type c_blood.
- 5 In the ω_b text field, type omega_head.
- 6 In the T_b text field, type 0.

Initial Values 1

- 1 In the **Model Builder** window, click **Initial Values 1**.
- 2 In the **Settings** window for **Initial Values**, locate the **Initial Values** section.
- 3 In the dT text field, type 0.

DEFINITIONS

Perfectly Matched Layer 1 (pml1)

- 1 In the **Definitions** toolbar, click  **Perfectly Matched Layer**.
- 2 In the **Settings** window for **Perfectly Matched Layer**, locate the **Domain Selection** section.
- 3 From the **Selection** list, choose **PML**.
- 4 Locate the **Geometry** section. From the **Type** list, choose **Spherical**.



ELECTROMAGNETIC WAVES, FREQUENCY DOMAIN (EMW)

In the **Model Builder** window, under **Component 1 (comp1)** click **Electromagnetic Waves, Frequency Domain (emw)**.

Perfect Electric Conductor 2

- 1 In the **Physics** toolbar, click  **Boundaries** and choose **Perfect Electric Conductor**.
- 2 Select Boundaries 54 and 58 only.

Scattering Boundary Condition 1

- 1 In the **Physics** toolbar, click  **Boundaries** and choose **Scattering Boundary Condition**.
- 2 Select Boundaries 5–8, 33, 34, 39, and 44 only.
- 3 In the **Settings** window for **Scattering Boundary Condition**, locate the **Boundary Selection** section.
- 4 Click  **Create Selection**.
- 5 In the **Create Selection** dialog box, type PML_boundary in the **Selection name** text field.
- 6 Click **OK**.
- 7 In the **Settings** window for **Scattering Boundary Condition**, locate the **Scattering Boundary Condition** section.
- 8 From the **Scattered wave type** list, choose **Spherical wave**.

Lumped Port 1

- 1 In the **Physics** toolbar, click  **Boundaries** and choose **Lumped Port**.
- 2 Select Boundary 55 only.
For the first port, wave excitation is **on** by default.
- 3 In the **Settings** window for **Lumped Port**, locate the **Lumped Port Properties** section.
- 4 In the V_0 text field, type 45.5.
- 5 Locate the **Settings** section. In the Z_{ref} text field, type 75[ohm].

Specific Absorption Rate I

- 1 In the **Physics** toolbar, click  **Domains** and choose **Specific Absorption Rate**.
- 2 Select Domain 6 only.

MESH I

Use the free meshing for the head, the patch, and surrounding air. For the PML regions, use swept meshing. This gives more control of the mesh resolution in the absorbing direction, which is crucial to get convergence with iterative solvers.

Free Triangular I

- 1 In the **Mesh** toolbar, click  **Boundary** and choose **Free Triangular**.
- 2 In the **Settings** window for **Free Triangular**, locate the **Boundary Selection** section.
- 3 From the **Selection** list, choose **PML_boundary**.

Swept I

- 1 In the **Mesh** toolbar, click  **Swept**.
- 2 In the **Settings** window for **Swept**, locate the **Domain Selection** section.
- 3 From the **Geometric entity level** list, choose **Domain**.
- 4 From the **Selection** list, choose **PML**.
- 5 Click to expand the **Source Faces** section. From the **Selection** list, choose **PML_boundary**.

Distribution I

- 1 Right-click **Swept I** and choose **Distribution**.
- 2 Right-click **Distribution I** and choose **Build Selected**.

Free Tetrahedral I

In the **Mesh** toolbar, click  **Free Tetrahedral**.

Size I

- 1 Right-click **Free Tetrahedral I** and choose **Size**.
- 2 In the **Settings** window for **Size**, locate the **Geometric Entity Selection** section.
- 3 From the **Geometric entity level** list, choose **Edge**.
- 4 Select Edges 81–84, 86, 87, and 89–91 only.
- 5 Locate the **Element Size** section. Click the **Custom** button.
- 6 Locate the **Element Size Parameters** section. Select the **Maximum element size** check box.
- 7 In the associated text field, type 0.0015.
- 8 Click  **Build All**.

Size 2

- 1 In the **Model Builder** window, right-click **Free Tetrahedral 1** and choose **Size**.
- 2 In the **Settings** window for **Size**, locate the **Geometric Entity Selection** section.
- 3 From the **Geometric entity level** list, choose **Domain**.
- 4 Select Domain 6 only.
- 5 Locate the **Element Size** section. From the **Predefined** list, choose **Extra fine**.
- 6 Click  **Build All**.

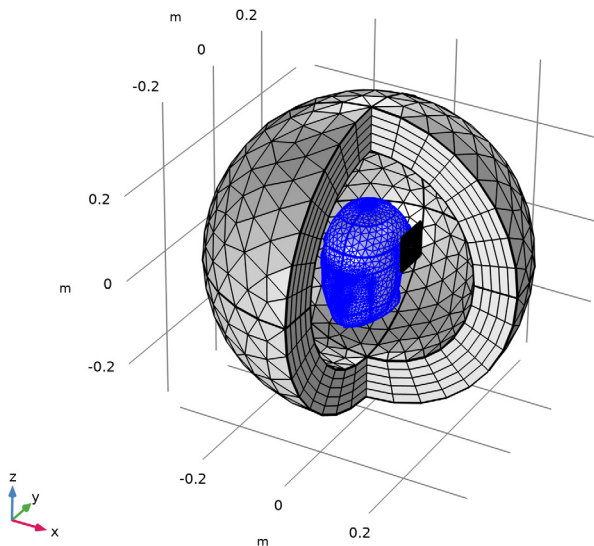

MULTIPHYSICS



Electromagnetic Heating 1 (emh1)

- 1 In the **Physics** toolbar, click  **Multiphysics Couplings** and choose **Domain> Electromagnetic Heating**.
- 2 In the **Settings** window for **Electromagnetic Heating**, locate the **Domain Selection** section.
- 3 From the **Selection** list, choose **Head**.

This brings the heat created by the electromagnetic waves to the heat transfer simulation.

ADD STUDY

Now, add a **Frequency-Stationary, One-Way Electromagnetic Heating** study sequence that adds a **Frequency Domain** study for the electromagnetic part and a **Stationary** study for the heat transfer part.

- 1 In the **Home** toolbar, click  **Add Study** to open the **Add Study** window.
- 2 Go to the **Add Study** window.
- 3 Find the **Studies** subsection. In the **Select Study** tree, select **Preset Studies for Selected Multiphysics>Frequency-Stationary, One-Way Electromagnetic Heating**.
- 4 Click **Add Study** in the window toolbar.
- 5 In the **Home** toolbar, click  **Add Study** to close the **Add Study** window.

STUDY I

Step 1: Frequency Domain

- 1 In the **Settings** window for **Frequency Domain**, locate the **Study Settings** section.
- 2 In the **Frequencies** text field, type $f0$.
- 3 Locate the **Physics and Variables Selection** section. In the table, clear the **Solve for** check box for **Bioheat Transfer (ht)**.

Step 2: Stationary

- 1 In the **Model Builder** window, click **Step 2: Stationary**.
- 2 In the **Settings** window for **Stationary**, locate the **Physics and Variables Selection** section.
- 3 In the table, clear the **Solve for** check box for **Electromagnetic Waves, Frequency Domain (emw)**.
- 4 In the **Model Builder** window, click **Study I**.
- 5 In the **Settings** window for **Study**, locate the **Study Settings** section.
- 6 Select the **Store solution for all intermediate study steps** check box.

Solution 1 (sol1)

- 1 In the **Study** toolbar, click  **Show Default Solver**.
- 2 In the **Model Builder** window, expand the **Solution I (sol1)** node.
Solve the heat transfer equation only in the head domain. For this fairly small problem, use a direct solver for faster convergence.
- 3 In the **Model Builder** window, expand the **Study I>Solver Configurations>Solution I (sol1)>Stationary Solver 2** node.

- 4 Right-click **Direct** and choose **Enable**.
- 5 In the **Study** toolbar, click  **Compute**.

RESULTS

Temperature (ht)

The first default plot group shows the temperature field as a surface plot. Follow the instructions below to reproduce [Figure 3](#).

- 1 In the **Settings** window for **3D Plot Group**, locate the **Plot Settings** section.
- 2 Clear the **Plot dataset edges** check box.
- 3 Click the  **Show More Options** button in the **Model Builder** toolbar.
- 4 In the **Show More Options** dialog box, in the tree, select the check box for the node **Results>Views**.
- 5 Click **OK**.

View 3D 5

- 1 In the **Model Builder** window, right-click **Views** and choose **View 3D**.
- 2 In the **Settings** window for **View 3D**, locate the **View** section.
- 3 Clear the **Show grid** check box.
- 4 Click to expand the **Light** section. Clear the **Scene light** check box.
- 5 Click the  **Go to YZ View** button in the **Graphics** toolbar.
- 6 Click the **Zoom Box** button in the **Graphics** toolbar and then use the mouse to zoom in.
- 7 Locate the **View** section. Select the **Lock camera** check box.

Temperature (ht)

- 1 In the **Model Builder** window, click **Temperature (ht)**.
- 2 In the **Settings** window for **3D Plot Group**, locate the **Plot Settings** section.
- 3 From the **View** list, choose **View 3D 5**.
- 4 In the **Temperature (ht)** toolbar, click  **Plot**.

Isothermal Contours (ht)

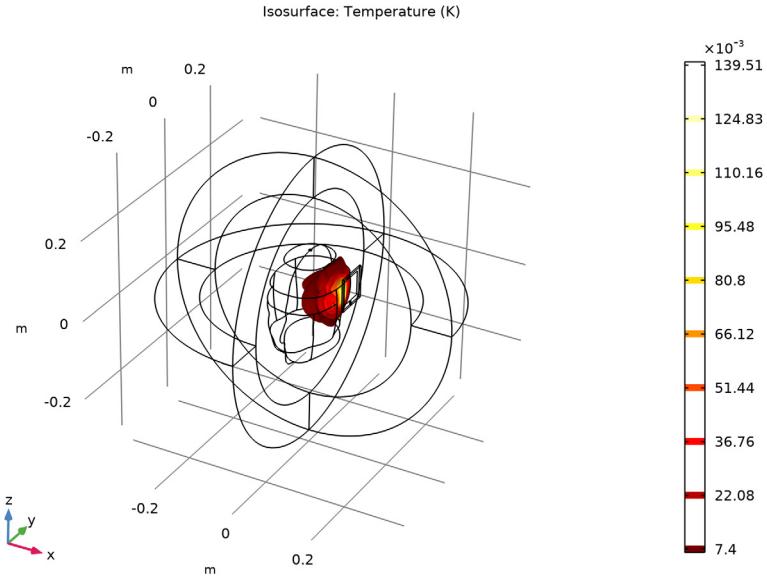

This is the isosurface plot of temperature.

Specific Absorption Rate (sar1)

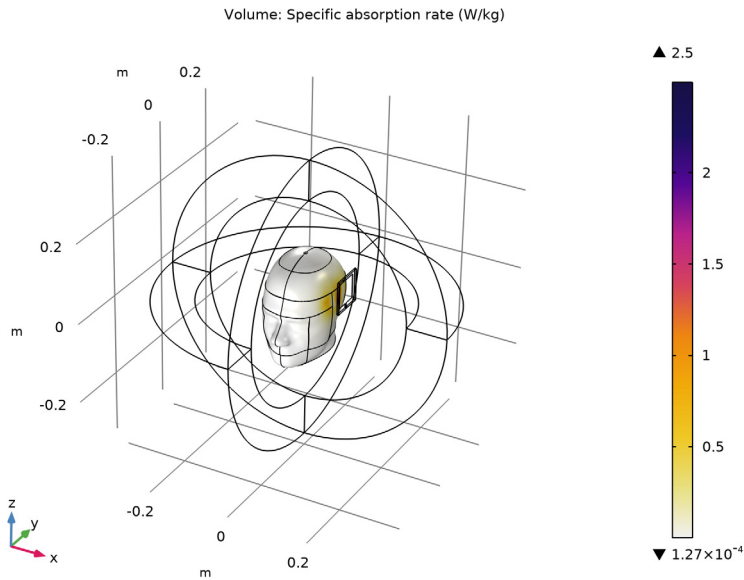

SAR, slices

Use the last default plot group, which is a slice plot of the electric field norm, as the starting point for reproducing the plot in [Figure 2](#).

- 1 In the **Model Builder** window, under **Results** click **Electric Field (emw)**.
- 2 In the **Settings** window for **3D Plot Group**, type SAR, slices in the **Label** text field.
- 3 Locate the **Plot Settings** section. Clear the **Plot dataset edges** check box.

Multislice

- 1 In the **Model Builder** window, expand the **SAR, slices** node.
- 2 Right-click **Multislice** and choose **Delete**.

Slice 1

- 1 In the **Model Builder** window, right-click **SAR, slices** and choose **Slice**.
- 2 In the **Settings** window for **Slice**, locate the **Expression** section.
- 3 In the **Expression** text field, type $\log_{10}(\text{emw.SAR})$.
- 4 Locate the **Plane Data** section. From the **Plane** list, choose **XY-planes**.
- 5 In the **Planes** text field, type 20.

6 In the **SAR, slices** toolbar, click  **Plot**.

View 3D 6

- 1 In the **Model Builder** window, right-click **Views** and choose **View 3D**.
- 2 In the **Settings** window for **View 3D**, locate the **Light** section.
- 3 Clear the **Scene light** check box.
- 4 Locate the **View** section. Clear the **Show grid** check box.
- 5 Click the  **Go to Default View** button in the **Graphics** toolbar.
- 6 Rotate the geometry to see the slices.
- 7 Select the **Lock camera** check box.

SAR, slices

- 1 In the **Model Builder** window, click **SAR, slices**.
- 2 In the **Settings** window for **3D Plot Group**, locate the **Plot Settings** section.
- 3 From the **View** list, choose **View 3D 6**.
- 4 In the **SAR, slices** toolbar, click  **Plot**.

Compare the calculated SAR plot to [Figure 2](#).

Relative Permittivity, Average (emw)

- 1 In the **Home** toolbar, click  **Add Plot Group** and choose **3D Plot Group**.
- 2 In the **Settings** window for **3D Plot Group**, type Relative Permittivity, Average (emw) in the **Label** text field.

Volume 1

- 1 Right-click **Relative Permittivity, Average (emw)** and choose **Volume**.
- 2 In the **Settings** window for **Volume**, locate the **Expression** section.
- 3 In the **Expression** text field, type `emw.eprAv`.
- 4 Locate the **Coloring and Style** section. From the **Color table** list, choose **AuroraBorealis**.

Selection 1

- 1 Right-click **Volume 1** and choose **Selection**.
- 2 Select Domain 6 only.

Filter 1

- 1 In the **Model Builder** window, right-click **Volume 1** and choose **Filter**.
- 2 In the **Settings** window for **Filter**, locate the **Element Selection** section.
- 3 In the **Logical expression for inclusion** text field, type `z<0.05`.

4 In the **Relative Permittivity, Average (emw)** toolbar, click  **Plot**.

5 Click the  **Zoom In** button in the **Graphics** toolbar.

Average relative permittivity is visualized in [Figure 1](#).