

MRI Birdcage Coil

Introduction

This example involves designing and optimizing a birdcage coil so it can provide a homogeneous magnetic field distribution for a Magnetic Resonance Imaging (MRI) system. This is usually done to MRI systems so they can generate higher resolution images.

The homogeneous magnetic field is obtained by quadrature excitation and an optimal value of lumped elements in the coil. To find the optimal value at the desired Larmor frequency with an air phantom, a parametric sweep is carried out for the capacitance of the coil's lumped elements. The performance of the coil, loaded with a human head phantom, is also studied.

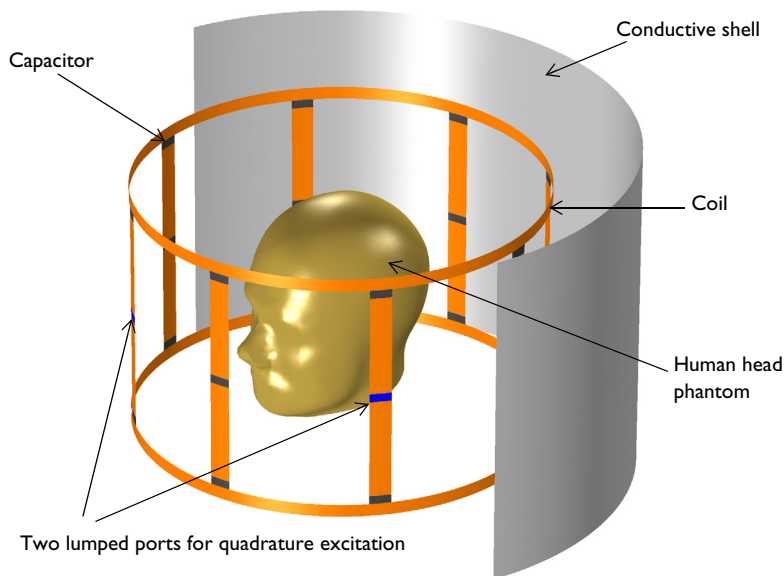

Figure 1: The birdcage coil is shielded by a cylindrical conductive shell. The front part of the shield is removed for visualization purposes. Absorbing boundaries are not included in this figure.

Model Definition

Figure 1 shows the geometry of the example, which consists of a birdcage coil placed around a human head phantom. Noticeably, there are a number of capacitors on the coil. These determine the resonant frequency of the coil and the homogeneity of the field it produces. The coil is placed inside an RF shield. The coil surfaces and the shield around the coil are assigned a Perfect Electric Conductor (PEC) condition. Lumped ports are

used to provide quadrature excitation for the coil, while the coil's capacitors are defined using lumped elements.

The air domain around the coil is modeled using an air sphere. Scattering boundary conditions are used along the sphere's boundaries to prevent any reflections into the modeling domain from the outermost boundaries.

To obtain a homogeneous field at the Larmor frequency for an air phantom, the capacitance of the lumped elements in the coil are tuned using a parametric sweep. The circularity of the field is evaluated by estimating the axial ratio of the magnetic field around the phantom. The sum of the axial ratio in dB is evaluated by the line integration of the following quantity:

$$20\log_{10}((B_{\text{right}}+B_{\text{left}})/(B_{\text{right}}-B_{\text{left}}))$$

Here, B_{right} and B_{left} are the right- and left-hand rotating components of the magnetic field, respectively. The homogeneity of the field is quantified by evaluating the standard deviation of the electric field around the phantom.

The automatic mesh control option in the Electromagnetic Waves, Frequency Domain interface is used with the maximum mesh element size as 1/6 of free space wavelength. This example also estimates the homogeneity and circularity of the field in the coil when loaded with a human head phantom.

Results and Discussion

[Figure 2](#) shows the magnetic field around the air phantom with an optimum value for the capacitance of the lumped elements at the Larmor frequency. The real part of the magnetic flux density is almost orthogonal to the imaginary part of it, which indicates the flux is rotating circularly.

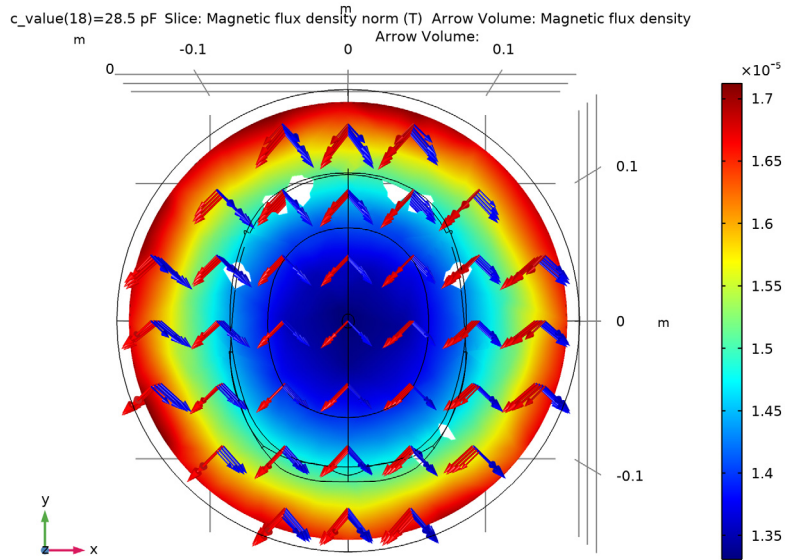

Figure 2: Magnetic density norm distribution with an arrow plot of the real (red) and imaginary (blue) part of the magnetic flux density for the coil only.

Figure 3 shows the field for the coil loaded with the human head phantom. Compared to the case with an air phantom, the uniformity and circularity of the field is distorted, due

to the high dielectric loading in the middle of the coil. The coil's capacitors can be tuned further for this loaded case.

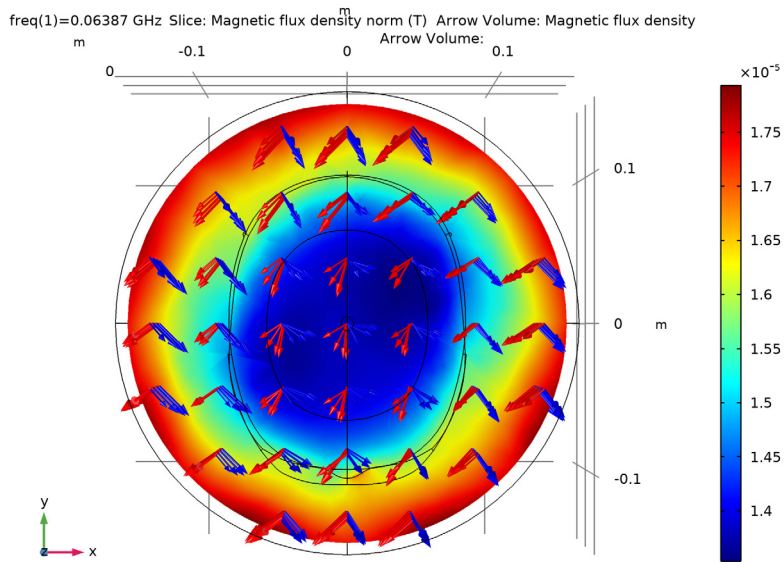

Figure 3: Magnetic density norm distribution with an arrow plot that shows the real (red) and imaginary (blue) part of the magnetic flux density when loaded with the human head phantom

Figure 4 and Figure 5 show the integration of the axial ratio of the magnetic flux density and the standard deviation of the electric field norm around the head model for different values of the lumped elements' capacitances. To achieve a homogeneous circularly-polarized magnetic field, it can be seen that the optimal value of the capacitance is around 28 pF.

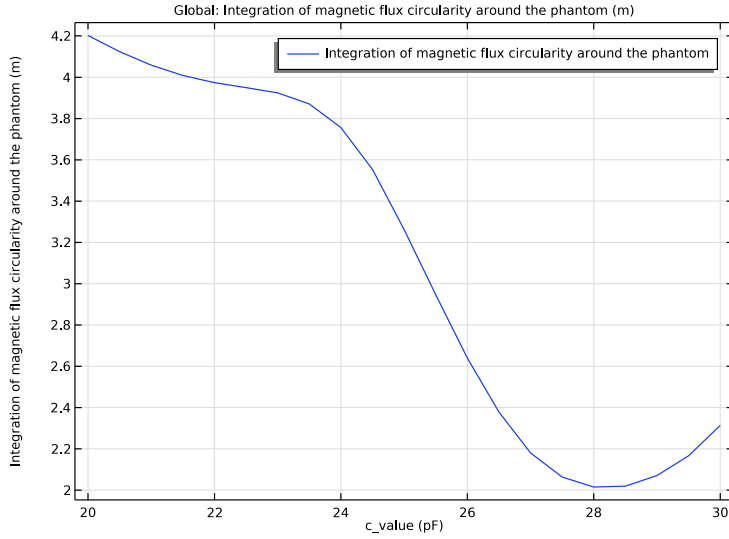

Figure 4: The integration of the axial ratio of the magnetic flux density around the head model

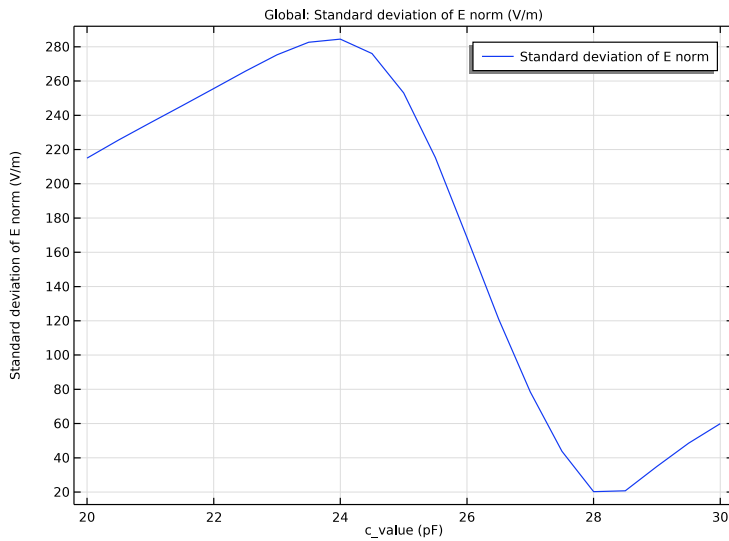



Figure 5: The standard deviation of the electric field norm around the head model

Application Library path: RF_Module/Passive_Devices/mri_coil



Modeling Instructions

From the **File** menu, choose **New**.

NEW

In the **New** window, click  **Model Wizard**.

MODEL WIZARD

- 1 In the **Model Wizard** window, click  **3D**.
- 2 In the **Select Physics** tree, select **Radio Frequency>Electromagnetic Waves, Frequency Domain (emw)**.
- 3 Click **Add**.
- 4 Click  **Study**.
- 5 In the **Select Study** tree, select **General Studies>Frequency Domain**.
- 6 Click  **Done**.

STUDY I

Step 1: Frequency Domain

- 1 In the **Model Builder** window, under **Study I** click **Step 1: Frequency Domain**.
- 2 In the **Settings** window for **Frequency Domain**, locate the **Study Settings** section.
- 3 In the **Frequencies** text field, type 63.87 [MHz].

GLOBAL DEFINITIONS

Parameters I





- 1 In the **Model Builder** window, under **Global Definitions** click **Parameters I**.
- 2 In the **Settings** window for **Parameters**, locate the **Parameters** section.
- 3 In the table, enter the following settings:

Name	Expression	Value	Description
c_value	10 [pF]	1E-11 F	Capacitance used on the rungs
r_coil	0.24 [m]	0.24 m	Radius of the coil

Name	Expression	Value	Description
h_coil	0.3[m]	0.3 m	Height of the coil
l_element	0.01[m]	0.01 m	Length of the capacitive elements

GEOMETRY I

The model geometry is available as a parameterized geometry sequence in a separate MPH-file. If you want to build it from scratch, follow the instructions in the section Appendix: Geometry Modeling Instructions. Otherwise load it from file with the following steps.

- 1 In the **Geometry** toolbar, click  **Insert Sequence**.
- 2 Browse to the model's Application Libraries folder and double-click the file `mri_coil_geom_sequence.mph`.
- 3 In the **Geometry** toolbar, click  **Build All**.
- 4 Click the  **Zoom Extents** button in the **Graphics** toolbar.
- 5 Click the  **Wireframe Rendering** button in the **Graphics** toolbar.

Import I (impI)

- 1 In the **Geometry** toolbar, click  **Import**.
- 2 In the **Settings** window for **Import**, locate the **Import** section.
- 3 Click **Browse**.
- 4 Browse to the model's Application Libraries folder and double-click the file `mri_coil.mphbin`.

Form Union (fin)

- 1 In the **Model Builder** window, click **Form Union (fin)**.
- 2 In the **Settings** window for **Form Union/Assembly**, locate the **Form Union/Assembly** section.
- 3 From the **Repair tolerance** list, choose **Absolute**.
- 4 In the **Absolute repair tolerance** text field, type `2.0E-9`.

Adjusting the tolerance is required only if you build the geometry with CAD kernel. The default tolerance is fine if you use COMSOL kernel.

5 In the **Geometry** toolbar, click  **Build All**.

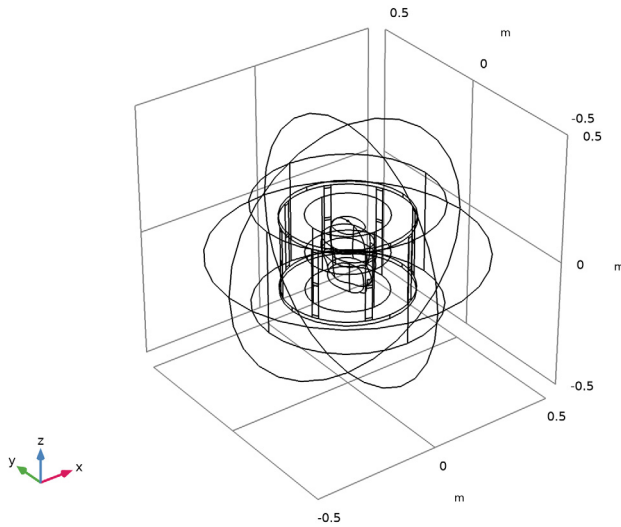



6 Click  **Build All**.

Create a set of selections to be used when setting up the physics. First, create a selection for the coil surfaces.

DEFINITIONS

Coil

- 1 In the **Definitions** toolbar, click  **Explicit**.
- 2 Click the  **Zoom In** button in the **Graphics** toolbar.
- 3 In the **Settings** window for **Explicit**, type *Coil* in the **Label** text field.
- 4 Locate the **Input Entities** section. From the **Geometric entity level** list, choose **Boundary**.
- 5 Click  **Paste Selection**.
- 6 In the **Paste Selection** dialog box, type 9 10 11 12 14 16 19 21 31 33 36 38 66 67 76 77 85 87 90 92 95 97 100 102 in the **Selection** text field.

7 Click **OK**.

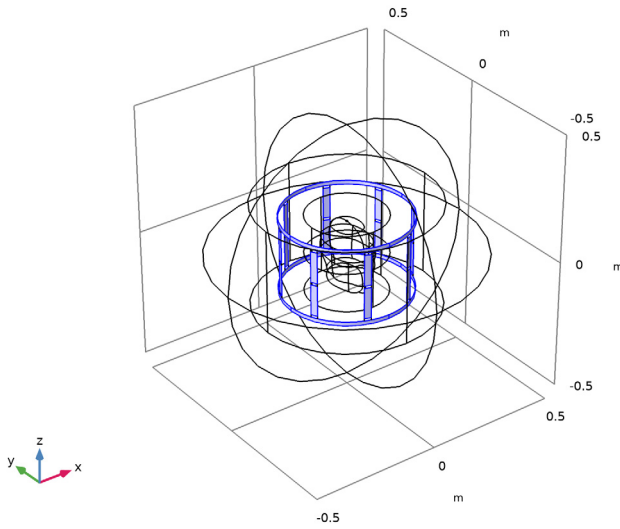

Add a selection for the edges around the coil to evaluate the average field.

Circle

- 1 In the **Definitions** toolbar, click  **Explicit**.
- 2 In the **Settings** window for **Explicit**, type **Circle** in the **Label** text field.
- 3 Locate the **Input Entities** section. From the **Geometric entity level** list, choose **Edge**.
- 4 Select Edge 61 only.

5 Select the **Group by continuous tangent** check box.

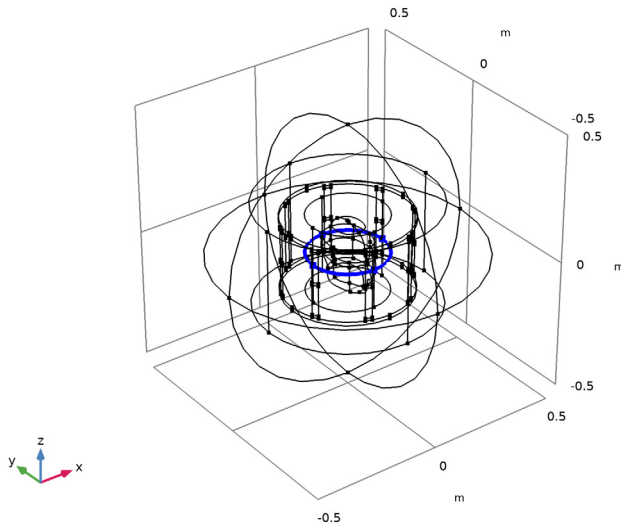

Add a selection for the absorbing boundaries surrounding the model domain.

Absorbing boundaries

- 1 In the **Definitions** toolbar, click  **Explicit**.
- 2 In the **Settings** window for **Explicit**, type Absorbing boundaries in the **Label** text field.
- 3 Locate the **Input Entities** section. From the **Geometric entity level** list, choose **Boundary**.
- 4 Select Boundary 4 only.

5 Select the **Group by continuous tangent** check box.

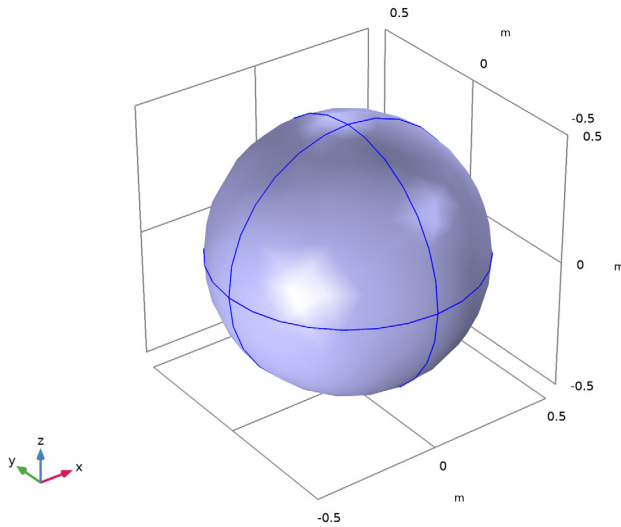

Define the operators to evaluate the average field around the coil.

Average 1 (aveop1)

- 1 In the **Definitions** toolbar, click  **Nonlocal Couplings** and choose **Average**.
- 2 In the **Settings** window for **Average**, locate the **Source Selection** section.
- 3 From the **Geometric entity level** list, choose **Edge**.
- 4 From the **Selection** list, choose **Circle**.

Integration 1 (intop1)

- 1 In the **Definitions** toolbar, click  **Nonlocal Couplings** and choose **Integration**.
- 2 In the **Settings** window for **Integration**, locate the **Source Selection** section.
- 3 From the **Geometric entity level** list, choose **Edge**.
- 4 From the **Selection** list, choose **Circle**.

Define the variables to evaluate the axial ratio of the magnetic field and the standard deviation of the electric field.

Variables 1

- 1 In the **Definitions** toolbar, click  **Local Variables**.
- 2 In the **Settings** window for **Variables**, locate the **Variables** section.

3 In the table, enter the following settings:

Name	Expression	Unit	Description
Bleft	$\text{abs}(\text{emw.Bx} + \text{j} * \text{emw.By})$	T	Left hand rotating component of magnetic flux
Bright	$\text{abs}(\text{emw.Bx} - \text{j} * \text{emw.By})$	T	Right hand rotating component of magnetic flux
BaxialratioidB	$20 * \log_{10}((\text{Bright} + \text{Bleft}) / (\text{Bright} - \text{Bleft}))$		Magnetic flux axial ratio
intBaxialratioidB	$\text{intop1}(\text{abs}(\text{BaxialratioidB}))$	m	Integration of magnetic flux circularity around the phantom
stdev	$\text{sqrt}(\text{aveop1}(\text{emw.normE}^2) - \text{aveop1}(\text{emw.normE})^2)$	V/m	Standard deviation of E norm

View 1

Hide the outermost boundaries to view the interior parts when setting up the physics.

Hide for Physics 1

- 1 In the **Model Builder** window, right-click **View 1** and choose **Hide for Physics**.
- 2 In the **Settings** window for **Hide for Physics**, locate the **Geometric Entity Selection** section.
- 3 From the **Geometric entity level** list, choose **Boundary**.
- 4 Click  **Paste Selection**.
- 5 In the **Paste Selection** dialog box, type 1-5, 8, 23, 26, 29, 63-65, 68-71 in the **Selection** text field.
- 6 Click **OK**.

MATERIALS

Use the material properties of air for all the domains in the model.

Material 1 (mat1)

- 1 In the **Model Builder** window, under **Component 1 (comp1)** right-click **Materials** and choose **Blank Material**.
- 2 In the **Settings** window for **Material**, locate the **Material Contents** section.

3 In the table, enter the following settings:

Property	Variable	Value	Unit	Property group
Relative permittivity	epsilon _{nr_iso} ; epsilon _{nrii} = epsilon _{nr_iso} , epsilon _{nrij} = 0	1		Basic
Relative permeability	mu _{r_iso} ; mu _{rii} = mu _{r_iso} , mu _{rij} = 0	1		Basic
Electrical conductivity	sigma _{iso} ; sigma _{iai} = sigma _{iso} , sigma _{aij} = 0	0	S/m	Basic

ELECTROMAGNETIC WAVES, FREQUENCY DOMAIN (EMW)

Set up the physics for the model. Define PEC condition for the coil boundaries and provide quadrature excitation for the coil using lumped ports. Make use of lumped elements to model the capacitors in the coil.



Perfect Electric Conductor 2

- 1 In the **Model Builder** window, under **Component 1 (comp1)** right-click **Electromagnetic Waves, Frequency Domain (emw)** and choose **Perfect Electric Conductor**.
- 2 In the **Settings** window for **Perfect Electric Conductor**, locate the **Boundary Selection** section.
- 3 From the **Selection** list, choose **Coil**.

Perfect Electric Conductor 3

- 1 In the **Physics** toolbar, click  **Boundaries** and choose **Perfect Electric Conductor**.
- 2 Select Boundaries 5, 6, 65, and 78 only.

Lumped Port 1

- 1 In the **Physics** toolbar, click  **Boundaries** and choose **Lumped Port**.
- 2 Click the  **Zoom In** button in the **Graphics** toolbar.

3 Select Boundary 37 only.

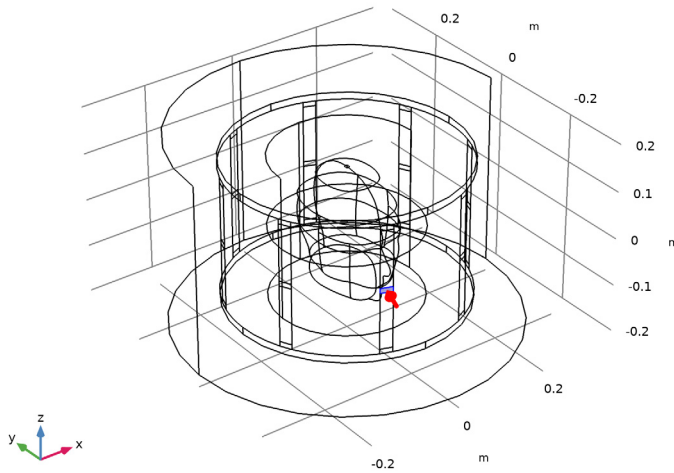

For the first port, wave excitation is **on** by default.

4 In the **Settings** window for **Lumped Port**, locate the **Lumped Port Properties** section.

5 In the V_0 text field, type 200.

Lumped Port 2

1 In the **Physics** toolbar, click  **Boundaries** and choose **Lumped Port**.

2 Select Boundary 101 only.

3 In the **Settings** window for **Lumped Port**, locate the **Lumped Port Properties** section.

4 From the **Wave excitation at this port** list, choose **On**.

5 In the V_0 text field, type 200.

6 In the θ_{in} text field, type $\pi/2$.

Lumped Element 1

1 In the **Physics** toolbar, click  **Boundaries** and choose **Lumped Element**.

2 Select Boundary 91 only.

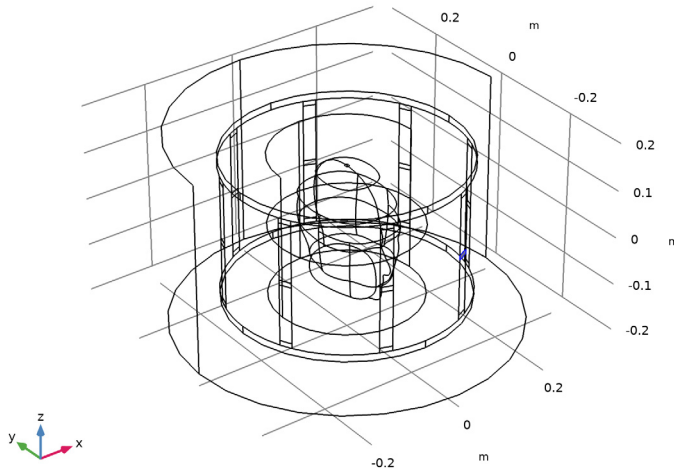

3 In the **Settings** window for **Lumped Element**, locate the **Settings** section.

4 From the **Lumped element device** list, choose **Capacitor**.

5 In the C_{element} text field, type c_value .

Lumped Element 2

1 In the **Physics** toolbar, click  **Boundaries** and choose **Lumped Element**.

2 Select Boundary 96 only.

3 In the **Settings** window for **Lumped Element**, locate the **Settings** section.

4 From the **Lumped element device** list, choose **Capacitor**.

5 In the C_{element} text field, type c_value .

Lumped Element 3

1 In the **Physics** toolbar, click  **Boundaries** and choose **Lumped Element**.

2 Select Boundary 86 only.

3 In the **Settings** window for **Lumped Element**, locate the **Settings** section.

4 From the **Lumped element device** list, choose **Capacitor**.

5 In the C_{element} text field, type c_value .

Lumped Element 4

1 In the **Physics** toolbar, click  **Boundaries** and choose **Lumped Element**.

- 2 Select Boundary 32 only.
- 3 In the **Settings** window for **Lumped Element**, locate the **Settings** section.
- 4 From the **Lumped element device** list, choose **Capacitor**.
- 5 In the C_{element} text field, type c_value .

Lumped Element 5

- 1 In the **Physics** toolbar, click  **Boundaries** and choose **Lumped Element**.
- 2 Select Boundary 15 only.
- 3 In the **Settings** window for **Lumped Element**, locate the **Settings** section.
- 4 From the **Lumped element device** list, choose **Capacitor**.
- 5 In the C_{element} text field, type c_value .

Lumped Element 6

- 1 In the **Physics** toolbar, click  **Boundaries** and choose **Lumped Element**.
- 2 Select Boundary 20 only.
- 3 In the **Settings** window for **Lumped Element**, locate the **Settings** section.
- 4 From the **Lumped element device** list, choose **Capacitor**.
- 5 In the C_{element} text field, type c_value .

Lumped Element 7

- 1 In the **Physics** toolbar, click  **Boundaries** and choose **Lumped Element**.
- 2 Select Boundary 35 only.
- 3 In the **Settings** window for **Lumped Element**, locate the **Settings** section.
- 4 From the **Lumped element device** list, choose **Capacitor**.
- 5 In the C_{element} text field, type c_value .

Lumped Element 8

- 1 In the **Physics** toolbar, click  **Boundaries** and choose **Lumped Element**.
- 2 Select Boundary 89 only.
- 3 In the **Settings** window for **Lumped Element**, locate the **Settings** section.
- 4 From the **Lumped element device** list, choose **Capacitor**.
- 5 In the C_{element} text field, type c_value .

Lumped Element 9

- 1 In the **Physics** toolbar, click  **Boundaries** and choose **Lumped Element**.
- 2 Select Boundary 99 only.

- 3 In the **Settings** window for **Lumped Element**, locate the **Settings** section.
- 4 From the **Lumped element device** list, choose **Capacitor**.
- 5 In the C_{element} text field, type c_value .

Lumped Element 10

- 1 In the **Physics** toolbar, click  **Boundaries** and choose **Lumped Element**.
- 2 Select Boundary 94 only.
- 3 In the **Settings** window for **Lumped Element**, locate the **Settings** section.
- 4 From the **Lumped element device** list, choose **Capacitor**.
- 5 In the C_{element} text field, type c_value .

Lumped Element 11

- 1 In the **Physics** toolbar, click  **Boundaries** and choose **Lumped Element**.
- 2 Select Boundary 84 only.
- 3 In the **Settings** window for **Lumped Element**, locate the **Settings** section.
- 4 From the **Lumped element device** list, choose **Capacitor**.
- 5 In the C_{element} text field, type c_value .

Lumped Element 12

- 1 In the **Physics** toolbar, click  **Boundaries** and choose **Lumped Element**.
- 2 Select Boundary 30 only.
- 3 In the **Settings** window for **Lumped Element**, locate the **Settings** section.
- 4 From the **Lumped element device** list, choose **Capacitor**.
- 5 In the C_{element} text field, type c_value .

Lumped Element 13

- 1 In the **Physics** toolbar, click  **Boundaries** and choose **Lumped Element**.
- 2 Select Boundary 13 only.
- 3 In the **Settings** window for **Lumped Element**, locate the **Settings** section.
- 4 From the **Lumped element device** list, choose **Capacitor**.
- 5 In the C_{element} text field, type c_value .

Lumped Element 14

- 1 In the **Physics** toolbar, click  **Boundaries** and choose **Lumped Element**.
- 2 Select Boundary 18 only.
- 3 In the **Settings** window for **Lumped Element**, locate the **Settings** section.

- 4 From the **Lumped element device** list, choose **Capacitor**.
- 5 In the C_{element} text field, type `c_value`.

Lumped Element 15

- 1 In the **Physics** toolbar, click  **Boundaries** and choose **Lumped Element**.
- 2 Select Boundary 39 only.
- 3 In the **Settings** window for **Lumped Element**, locate the **Settings** section.
- 4 From the **Lumped element device** list, choose **Capacitor**.
- 5 In the C_{element} text field, type `c_value`.

Lumped Element 16

- 1 In the **Physics** toolbar, click  **Boundaries** and choose **Lumped Element**.
- 2 Select Boundary 93 only.
- 3 In the **Settings** window for **Lumped Element**, locate the **Settings** section.
- 4 From the **Lumped element device** list, choose **Capacitor**.
- 5 In the C_{element} text field, type `c_value`.

Lumped Element 17

- 1 In the **Physics** toolbar, click  **Boundaries** and choose **Lumped Element**.
- 2 Select Boundary 103 only.
- 3 In the **Settings** window for **Lumped Element**, locate the **Settings** section.
- 4 From the **Lumped element device** list, choose **Capacitor**.
- 5 In the C_{element} text field, type `c_value`.

Lumped Element 18

- 1 In the **Physics** toolbar, click  **Boundaries** and choose **Lumped Element**.
- 2 Select Boundary 98 only.
- 3 In the **Settings** window for **Lumped Element**, locate the **Settings** section.
- 4 From the **Lumped element device** list, choose **Capacitor**.
- 5 In the C_{element} text field, type `c_value`.

Lumped Element 19

- 1 In the **Physics** toolbar, click  **Boundaries** and choose **Lumped Element**.
- 2 Select Boundary 88 only.
- 3 In the **Settings** window for **Lumped Element**, locate the **Settings** section.
- 4 From the **Lumped element device** list, choose **Capacitor**.

5 In the C_{element} text field, type c_{value} .

Lumped Element 20

- 1 In the **Physics** toolbar, click  **Boundaries** and choose **Lumped Element**.
- 2 Select Boundary 34 only.
- 3 In the **Settings** window for **Lumped Element**, locate the **Settings** section.
- 4 From the **Lumped element device** list, choose **Capacitor**.
- 5 In the C_{element} text field, type c_{value} .

Lumped Element 21

- 1 In the **Physics** toolbar, click  **Boundaries** and choose **Lumped Element**.
- 2 Select Boundary 17 only.
- 3 In the **Settings** window for **Lumped Element**, locate the **Settings** section.
- 4 From the **Lumped element device** list, choose **Capacitor**.
- 5 In the C_{element} text field, type c_{value} .

Lumped Element 22

- 1 In the **Physics** toolbar, click  **Boundaries** and choose **Lumped Element**.
- 2 Select Boundary 22 only.
- 3 In the **Settings** window for **Lumped Element**, locate the **Settings** section.
- 4 From the **Lumped element device** list, choose **Capacitor**.
- 5 In the C_{element} text field, type c_{value} .



Scattering Boundary Condition 1

- 1 In the **Physics** toolbar, click  **Boundaries** and choose **Scattering Boundary Condition**.
- 2 In the **Settings** window for **Scattering Boundary Condition**, locate the **Boundary Selection** section.
- 3 From the **Selection** list, choose **Absorbing boundaries**.

STUDY 1

Add a parametric sweep for the capacitance of the lumped elements in the coil.

Parametric Sweep

- 1 In the **Study** toolbar, click  **Parametric Sweep**.
- 2 In the **Settings** window for **Parametric Sweep**, locate the **Study Settings** section.
- 3 Click  **Add**.

4 In the table, enter the following settings:

Parameter name	Parameter value list	Parameter unit
c_value (Capacitance used on the rungs)		pF

5 Click  **Range**.

6 In the **Range** dialog box, type 20 in the **Start** text field.

7 In the **Step** text field, type 0.5.

8 In the **Stop** text field, type 30.

9 Click **Replace**.

10 In the **Study** toolbar, click  **Compute**.

RESULTS

Electric Field (emw)

Click the  **Zoom Extents** button in the **Graphics** toolbar.

Study 1/Solution 1 (sol1)

Add a selection for the domains around the phantom to visualize the fields.

1 In the **Model Builder** window, expand the **Results>Datasets** node, then click **Study 1/Solution 1 (sol1)**.

Selection

1 In the **Results** toolbar, click  **Attributes** and choose **Selection**.

2 In the **Settings** window for **Selection**, locate the **Geometric Entity Selection** section.

3 From the **Geometric entity level** list, choose **Domain**.

4 Select Domains 3–6 only.

Add a slice plot for the magnetic field and arrow plots to view the direction of the magnetic field.

3D Plot Group 2

1 In the **Results** toolbar, click  **3D Plot Group**.

2 In the **Settings** window for **3D Plot Group**, locate the **Data** section.

3 From the **Parameter value (c_value (pF))** list, choose **28.5**.

Slice 1

1 In the **3D Plot Group 2** toolbar, click  **Slice**.

- 2 In the **Settings** window for **Slice**, locate the **Plane Data** section.
- 3 From the **Plane** list, choose **XY-planes**.
- 4 In the **Planes** text field, type 1.
- 5 Click **Replace Expression** in the upper-right corner of the **Expression** section. From the menu, choose **Component 1 (comp1)>Electromagnetic Waves, Frequency Domain>Magnetic>emw.normB - Magnetic flux density norm - T**.

3D Plot Group 2

In the **Model Builder** window, click **3D Plot Group 2**.





Arrow Volume 1

- 1 In the **3D Plot Group 2** toolbar, click  **Arrow Volume**.
- 2 In the **Settings** window for **Arrow Volume**, click **Replace Expression** in the upper-right corner of the **Expression** section. From the menu, choose **Component 1 (comp1)>Electromagnetic Waves, Frequency Domain>Magnetic>emw.Bx, ..., emw.Bz - Magnetic flux density**.

3D Plot Group 2

In the **Model Builder** window, click **3D Plot Group 2**.

Arrow Volume 2

- 1 In the **3D Plot Group 2** toolbar, click  **Arrow Volume**.
- 2 In the **Settings** window for **Arrow Volume**, locate the **Expression** section.
- 3 In the **X component** text field, type $\text{imag}(\text{emw}.B_x)$.
- 4 In the **Y component** text field, type $\text{imag}(\text{emw}.B_y)$.
- 5 In the **Z component** text field, type $\text{imag}(\text{emw}.B_z)$.
- 6 Locate the **Coloring and Style** section. From the **Color** list, choose **Blue**.
- 7 In the **3D Plot Group 2** toolbar, click  **Plot**.
- 8 Click the  **Go to XY View** button in the **Graphics** toolbar.
- 9 Click the  **Zoom Extents** button in the **Graphics** toolbar.

The plot shows the homogeneous and circularly polarized magnetic field around the air phantom. It is plotted in [Figure 2](#).

1D Plot Group 3

In the **Home** toolbar, click  **Add Plot Group** and choose **1D Plot Group**.

Global 1

- 1 Right-click **1D Plot Group 3** and choose **Global**.

- 2 In the **Settings** window for **Global**, click **Replace Expression** in the upper-right corner of the **y-Axis Data** section. From the menu, choose **Component 1 (comp1)>Definitions>Variables>intBaxialratioidB - Integration of magnetic flux circularity around the phantom - m**.

ID Plot Group 3

- 1 In the **Model Builder** window, click **ID Plot Group 3**.
- 2 In the **ID Plot Group 3** toolbar, click  **Plot**.

ID Plot Group 4

In the **Home** toolbar, click  **Add Plot Group** and choose **ID Plot Group**.

Global 1

- 1 Right-click **ID Plot Group 4** and choose **Global**.
- 2 In the **Settings** window for **Global**, click **Replace Expression** in the upper-right corner of the **y-Axis Data** section. From the menu, choose **Component 1 (comp1)>Definitions>Variables>stdev - Standard deviation of E norm - V/m**.

ID Plot Group 4

- 1 In the **Model Builder** window, click **ID Plot Group 4**.
- 2 In the **ID Plot Group 4** toolbar, click  **Plot**.

It is obvious from the 1D plots that the optimum capacitance value for obtaining homogeneous magnetic field is around 28 pF. It is plotted in [Figure 4](#) and [Figure 5](#).

GLOBAL DEFINITIONS

Parameters 1

Now modify the capacitance of the lumped elements and rerun the model with the human head phantom.

- 1 In the **Model Builder** window, under **Global Definitions** click **Parameters 1**.
- 2 In the **Settings** window for **Parameters**, locate the **Parameters** section.
- 3 In the table, enter the following settings:

Name	Expression	Value	Description
c_value	28 [pF]	2.8E-11 F	Capacitance used on the rungs



MATERIALS

Material 2 (mat2)

- 1 In the **Model Builder** window, under **Component 1 (comp1)** right-click **Materials** and choose **Blank Material**.
- 2 Select Domains 5 and 6 only.
- 3 In the **Settings** window for **Material**, locate the **Material Contents** section.
- 4 In the table, enter the following settings:

Property	Variable	Value	Unit	Property group
Relative permittivity	epsilon_r_iso ; epsilon_r_ii = epsilon_r_iso, epsilon_r_ij = 0	40		Basic
Relative permeability	mu_r_iso ; mu_r_ii = mu_r_iso, mu_r_ij = 0	1		Basic
Electrical conductivity	sigma_iso ; sigma_ii = sigma_iso, sigma_ij = 0	0.9	S/m	Basic

ADD STUDY

- 1 In the **Home** toolbar, click  **Add Study** to open the **Add Study** window.
- 2 Go to the **Add Study** window.
- 3 Find the **Studies** subsection. In the **Select Study** tree, select **General Studies> Frequency Domain**.
- 4 Click **Add Study** in the window toolbar.
- 5 In the **Home** toolbar, click  **Add Study** to close the **Add Study** window.

STUDY 2

Step 1: Frequency Domain

- 1 In the **Settings** window for **Frequency Domain**, locate the **Study Settings** section.
- 2 In the **Frequencies** text field, type 63.87 [MHz].
- 3 In the **Home** toolbar, click  **Compute**.

RESULTS

Study 2/Solution 2 (sol2)

In the **Model Builder** window, under **Results>Datasets** click **Study 2/Solution 2 (sol2)**.

Selection

1 In the **Results** toolbar, click  **Attributes** and choose **Selection**.

Add a selection for the domains around the phantom to visualize the fields.

2 In the **Settings** window for **Selection**, locate the **Geometric Entity Selection** section.

3 From the **Geometric entity level** list, choose **Domain**.

4 Select Domains 3–6 only.

3D Plot Group 6

In the **Results** toolbar, click  **3D Plot Group**.

Slice 1

In the **3D Plot Group 6** toolbar, click  **Slice**.

3D Plot Group 6

1 In the **Settings** window for **3D Plot Group**, locate the **Data** section.

2 From the **Dataset** list, choose **Study 2/Solution 2 (sol2)**.

Slice 1

1 In the **Model Builder** window, click **Slice 1**.

2 In the **Settings** window for **Slice**, click **Replace Expression** in the upper-right corner of the **Expression** section. From the menu, choose **Component 1 (comp1)> Electromagnetic Waves, Frequency Domain>Magnetic>emw.normB - Magnetic flux density norm - T**.

3 Locate the **Plane Data** section. From the **Plane** list, choose **XY-planes**.

4 In the **Planes** text field, type 1.

3D Plot Group 6

In the **Model Builder** window, click **3D Plot Group 6**.

Arrow Volume 1

1 In the **3D Plot Group 6** toolbar, click  **Arrow Volume**.

2 In the **Settings** window for **Arrow Volume**, click **Replace Expression** in the upper-right corner of the **Expression** section. From the menu, choose **Component 1 (comp1)> Electromagnetic Waves, Frequency Domain>Magnetic>emw.Bx, ..., emw.Bz - Magnetic flux density**.

3D Plot Group 6

In the **Model Builder** window, click **3D Plot Group 6**.

Arrow Volume 2



- 1 In the **3D Plot Group 6** toolbar, click  **Arrow Volume**.
- 2 In the **Settings** window for **Arrow Volume**, locate the **Expression** section.
- 3 In the **X component** text field, type $\text{imag}(emw.Bx)$.
- 4 In the **Y component** text field, type $\text{imag}(emw.By)$.
- 5 In the **Z component** text field, type $\text{imag}(emw.Bz)$.
- 6 Locate the **Coloring and Style** section. From the **Color** list, choose **Blue**.

3D Plot Group 6



- 1 In the **Model Builder** window, click **3D Plot Group 6**.
- 2 In the **3D Plot Group 6** toolbar, click  **Plot**.

The plot shows that the magnetic field is homogeneous and circularly polarized even when the coil is loaded with the human head phantom. It is plotted in [Figure 3](#).

Global Evaluation 1

- 1 In the **Results** toolbar, click  **Global Evaluation**.
Evaluate the axial ratio of the magnetic field and the standard deviation of the electric field with the human head phantom.
- 2 In the **Settings** window for **Global Evaluation**, locate the **Data** section.
- 3 From the **Dataset** list, choose **Study 2/Solution 2 (sol2)**.
- 4 Click **Replace Expression** in the upper-right corner of the **Expressions** section. From the menu, choose **Component 1 (comp1)>Definitions>Variables>intBaxialratiodB - Integration of magnetic flux circularity around the phantom - m**.
- 5 Click  **Evaluate**.

Global Evaluation 2

- 1 In the **Results** toolbar, click  **Global Evaluation**.
- 2 In the **Settings** window for **Global Evaluation**, locate the **Data** section.
- 3 From the **Dataset** list, choose **Study 2/Solution 2 (sol2)**.
- 4 Click **Replace Expression** in the upper-right corner of the **Expressions** section. From the menu, choose **Component 1 (comp1)>Definitions>Variables>stdev - Standard deviation of E norm - V/m**.
- 5 Click  **Evaluate**.

Appendix: Geometry Modeling Instructions

From the **File** menu, choose **New**.

NEW

In the **New** window, click  **Model Wizard**.

MODEL WIZARD

- 1 In the **Model Wizard** window, click  **3D**.
- 2 Click **Done**.

GLOBAL DEFINITIONS

Parameters 1

- 1 In the **Model Builder** window, under **Global Definitions** click **Parameters 1**.
- 2 In the **Settings** window for **Parameters**, locate the **Parameters** section.
- 3 Click  **Load from File**.
- 4 Browse to the model's Application Libraries folder and double-click the file `mri_coil_parameters.txt`.
- 5 In the table, enter the following settings:

Name	Expression	Value	Description
t_ring	0.015[m]	0.015 m	

GEOMETRY 1

Cylinder 1 (cyl1)

- 1 In the **Geometry** toolbar, click  **Cylinder**.
- 2 In the **Settings** window for **Cylinder**, locate the **Size and Shape** section.
- 3 In the **Radius** text field, type `r_coil`.
- 4 In the **Height** text field, type `h_coil`.
- 5 Locate the **Position** section. In the **z** text field, type `-h_coil/2`.
- 6 Click to expand the **Layers** section. In the table, enter the following settings:

Layer name	Thickness (m)
Layer 1	t_ring

- 7 Clear the **Layers on side** check box.

8 Select the **Layers on bottom** check box.

9 Select the **Layers on top** check box.

Work Plane 1 (wp1)

1 In the **Geometry** toolbar, click  **Work Plane**.

2 In the **Settings** window for **Work Plane**, locate the **Plane Definition** section.

3 In the **z-coordinate** text field, type $-h_coil/2+t_ring$.

4 Click  **Show Work Plane**.

Work Plane 1 (wp1)>Circle 1 (c1)

1 In the **Work Plane** toolbar, click  **Circle**.

2 In the **Settings** window for **Circle**, locate the **Size and Shape** section.

3 In the **Radius** text field, type r_coil .

4 In the **Sector angle** text field, type 6.

5 Locate the **Rotation Angle** section. In the **Rotation** text field, type -22.5 .

Work Plane 1 (wp1)>Convert to Curve 1 (ccur1)

1 In the **Work Plane** toolbar, click  **Conversions** and choose **Convert to Curve**.

2 Select the object **c1** only.

3 In the **Settings** window for **Convert to Curve**, click  **Build Selected**.

Work Plane 1 (wp1)>Delete Entities 1 (del1)

1 In the **Work Plane** toolbar, click  **Delete**.

2 In the **Settings** window for **Delete Entities**, locate the **Entities or Objects to Delete** section.

3 From the **Geometric entity level** list, choose **Boundary**.

4 Click the  **Zoom In** button in the **Graphics** toolbar.

5 Click the  **Zoom In** button in the **Graphics** toolbar.

6 On the object **ccur1**, select Boundaries 2 and 3 only.

Extrude 1 (ext1)

1 In the **Model Builder** window, right-click **Geometry 1** and choose **Extrude**.

2 In the **Settings** window for **Extrude**, locate the **General** section.

3 From the **Input object handling** list, choose **Keep**.

4 Locate the **Distances** section. In the table, enter the following settings:

Distances (m)
$h_coil-2*t_ring$

Extrude 2 (ext2)



- 1 In the **Geometry** toolbar, click  **Extrude**.
- 2 In the **Settings** window for **Extrude**, locate the **Distances** section.
- 3 In the table, enter the following settings:

Distances (m)
<i>l_element</i>



Move 1 (mov1)

- 1 In the **Geometry** toolbar, click  **Transforms** and choose **Move**.
- 2 Select the object **ext2** only.
- 3 In the **Settings** window for **Move**, locate the **Displacement** section.
- 4 In the **z** text field, type $0 \cdot (h_{\text{coil}} - 2 \cdot t_{\text{ring}}) / 2 - l_{\text{element}} / 2 \cdot (h_{\text{coil}} - 2 \cdot t_{\text{ring}}) - l_{\text{element}}$.



Rotate 1 (rot1)

- 1 In the **Geometry** toolbar, click  **Transforms** and choose **Rotate**.
- 2 Select the objects **ext1**, **mov1(1)**, **mov1(2)**, and **mov1(3)** only.
- 3 In the **Settings** window for **Rotate**, locate the **Rotation** section.
- 4 In the **Angle** text field, type 0 45 90 135 180 225 270 315.
- 5 In the **Geometry** toolbar, click  **Build All**.

Convert to Surface 1 (csurl)

- 1 In the **Geometry** toolbar, click  **Conversions** and choose **Convert to Surface**.
- 2 Click in the **Graphics** window and then press Ctrl+A to select all objects.
- 3 In the **Settings** window for **Convert to Surface**, click  **Build Selected**.

Delete Entities 1 (dell)

- 1 In the **Geometry** toolbar, click  **Delete**.
- 2 In the **Settings** window for **Delete Entities**, locate the **Entities or Objects to Delete** section.
- 3 From the **Geometric entity level** list, choose **Boundary**.
- 4 Click the  **Wireframe Rendering** button in the **Graphics** toolbar.
- 5 On the object **csurl**, select Boundaries 3–6, 9, 10, 21, 22, 33, 34, 36, 39, 51, 52, 63, and 64 only.

Cylinder 2 (cyl2)

- 1 In the **Geometry** toolbar, click  **Cylinder**.

- 2 In the **Settings** window for **Cylinder**, locate the **Size and Shape** section.
- 3 In the **Radius** text field, type 0.15.
- 4 In the **Height** text field, type h_{coil} .
- 5 Locate the **Position** section. In the **z** text field, type $-h_{coil}/2$.
- 6 Locate the **Layers** section. In the table, enter the following settings:



Layer name	Thickness (m)
Layer 1	$h_{coil}/2$

- 7 Clear the **Layers on side** check box.
- 8 Select the **Layers on top** check box.

Cylinder 3 (cyl3)

- 1 In the **Geometry** toolbar, click  **Cylinder**.
- 2 In the **Settings** window for **Cylinder**, locate the **Size and Shape** section.
- 3 In the **Radius** text field, type $r_{coil}+0.1$.
- 4 In the **Height** text field, type $h_{coil}+0.1$.
- 5 Locate the **Position** section. In the **z** text field, type $-(h_{coil}+0.1)/2$.

Sphere 1 (sph1)

- 1 In the **Geometry** toolbar, click  **Sphere**.
- 2 In the **Settings** window for **Sphere**, locate the **Size** section.
- 3 In the **Radius** text field, type 0.5.
- 4 In the **Geometry** toolbar, click  **Build All**.