



# Probe Tube Microphone

## Introduction

---

It is often not possible to insert a normal microphone directly into the sound field being measured. The microphone may be too big to fit inside the measured system, such as for in-the-ear measurements for hearing aid fitting. The size of the microphone may also be too large compared to the wavelength, so that it disturbs the acoustic field. In these cases, a probe tube may be attached to the microphone case (see the sketch in [Figure 1](#)) in order to distance the microphone from the measurement point. In this model, the effect on the microphone's sensitivity due to the addition of this small probe is investigated, see [Ref. 1](#) (Chapter 4, pp. 160–162) for further details.

This is a time-dependent model of a generic probe tube microphone setup consisting of an external acoustic domain, an elastic probe tube, and the cavity in front of the microphone diaphragm; see the sketch in [Figure 1](#). The probe tube, modeled using the Pipe Acoustics, Transient interface, is connected to two separate 3D pressure acoustics domains, leading to a fully coupled acoustics simulation.

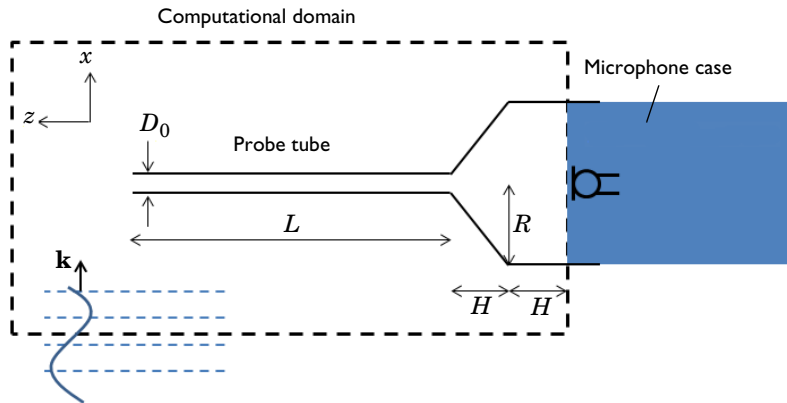

*Figure 1: Sketch of the probe tube microphone setup, consisting of a probe tube of length  $L$  and outer diameter  $D_0$ . The tube is connected to a cavity (with the indicated dimensions) in front of the microphone diaphragm. An external sound field hits the probe tube with wave vector  $\mathbf{k}$ .*

---

**Note:** This application requires the Acoustics Module.

---

## Model Definition

The probe tube microphone geometry and the computational domain considered in this model are shown schematically in [Figure 1](#). From right to left, the model consists of the cavity in front of the microphone, which takes the form of a cylinder of radius  $R$  and height  $H$  connected to a cone of bottom radius  $R$  and top radius  $D_0$ .  $D_0$  is also the outer diameter of the probe tube of length  $L$ . The probe is made of an elastic material with inner diameter  $2d_r = 2$  mm and wall thickness  $d_w = 0.3$  mm. The tube material is set to have a Young's modulus of 0.1 GPa and a Poisson's ratio of 0.4.

[Table 1](#) lists the model parameters,

TABLE 1: MODEL PARAMETERS.

VARIABLE	VALUE	DESCRIPTION
$f$	500 Hz	Incident wave frequency
$T$	$1/f$	Incident wave period
$\omega$	$2\pi f$	Incident wave angular frequency
$c_0$	343 m/s	Speed of sound at 20°C and 1 atm
$\lambda_{\min}$	$c_0/f$	Wavelength of the incident wave
$k$	$2\pi/\lambda_{\min}$	Wave number of the incident wave
$L$	20 mm	Probe tube length
$R$	5 mm	Microphone casing radius
$H$	5 mm	Cavity height
$d_r$	1 mm	Pipe inner radius
$d_w$	0.3 mm	Pipe wall thickness
$D_0$	$2d_r + 2d_w = 2.6$ mm	Probe tube outer diameter
$kD_0$	$kD_0 = 0.02$	Wave number times tube diameter
$d_{\text{visc}}$	0.1 mm	Viscous boundary layer thickness at 500 Hz

A sinusoidal wave moving in the positive  $x$  direction is incident on the probe tube microphone. The wave with an amplitude of 1 Pa is given by

$$p_{\text{in}} = 1 \text{ Pa} \cdot \sin(\omega t - kx) \quad (1)$$

where  $\omega$  is the angular frequency, and  $k$  is the wave number (these are given in [Table 1](#)). Such a plane monochromatic wave exists as a built-in option for the **Incident Pressure Field** feature in the interface. In the transient analysis, a ramp is automatically added to smoothly increase the background pressure field amplitude over the first period  $T = 1/f_0$ . This is

done to ensure numerical stability and can be deactivated under the **Incident Pressure Field** with the **Advanced Physics Options** turned on.

Modeled using the Pipe Acoustics, Transient interface, the long probe tube is treated as 1D structure. This assumption is valid as long as the interaction between the probe tube and the incoming sound field can be neglected. This, in turn, requires that  $kD_0 \ll 1$ , which is true for the current choice of parameters because  $kD_0 = 0.02$ ; see [Table 1](#).

Another important assumption is that there are no significant thermal and viscous boundary losses inside the probe tube. Also, this assumption holds for the current setup, where the incident field is a monochromatic wave. At a driving frequency of 500 Hz, the viscous boundary layer thickness inside the probe tube is of the order 0.1 mm, which is 10 times smaller than the internal radius  $d_r$ . The thickness of the boundary layer is proportional to  $1/\sqrt{f}$ .

Because the diaphragm is not a fully rigid structure, assume it to have a resistive loss given by the impedance  $Z = 100 \cdot 10^6 \text{ Ns/m}^5$ . This value is of the order of magnitude observed in common condenser microphones.

## *Results and Discussion*

---

An important parameter of a probe tube extension to a microphone is the relation between the pressure at the tip and the pressure at the diaphragm (as measured by the microphone). This transfer function is necessary to calibrate the measurement system. The pressure at the tip of the probe and the pressure at the diaphragm are shown in [Figure 2](#). After an initial transient, the solution becomes periodic after about 4 ms. Hereafter, the system has a gain of about 1.4 and a phase shift equal to  $\phi = \Delta t \cdot \omega = 0.1 \text{ ms} \cdot 2\pi f = 9^\circ$ . The gain and phase shift depend on the frequency content of the applied signal — in this case a pure harmonic tone of 500 Hz.

A full transfer function could be obtained, for example, by using a Gaussian pulse as the incident signal and then performing a Fourier transform of the signal. This requires resolving the frequency content with an appropriate mesh that would become very dense. Moreover, the model assumptions might not hold for the full range of frequencies.

[Figure 3](#) depicts the pressure distribution in the  $xz$ -plane at the end of the time interval shown in [Figure 2](#).

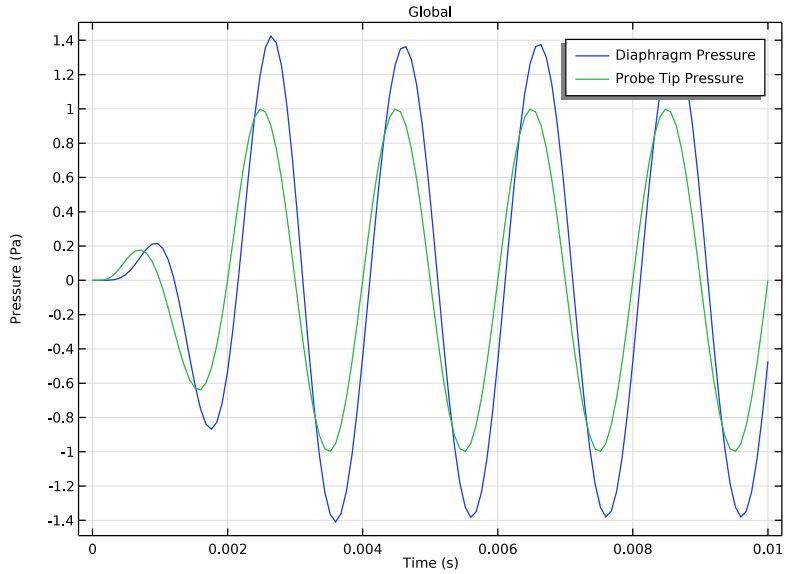

Figure 2: Pressure as function of time at the probes tip (green line) and at the microphone diaphragm (blue line).

Time=0.01 s

Slice: Pressure (Pa) Slice: Pressure (Pa) Line: Pressure (Pa)

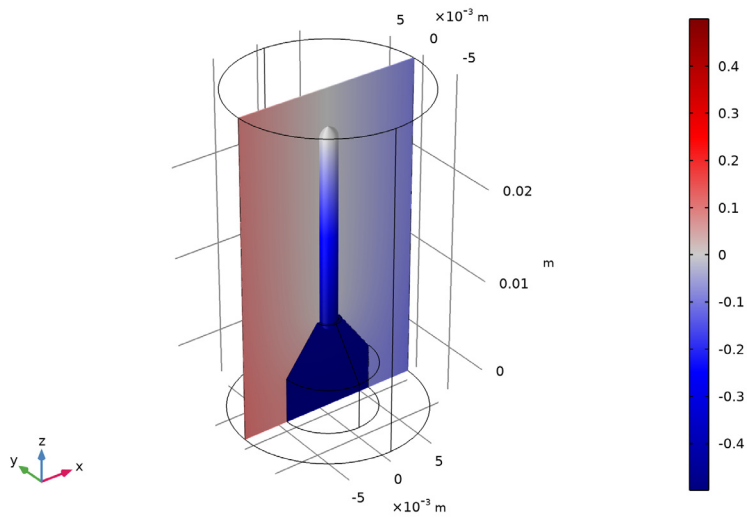

Figure 3: Pressure distribution in the xz-plane at time  $t = 10$  ms.

### COUPLING BETWEEN 1D AND 3D DOMAINS

The Pipe Acoustics domain (probe domain) is connected to the first Pressure Acoustics domain (exterior domain) through a pressure condition at the pipe end. This manual coupling ensures continuity of the pressure between the pipe domain and the incident pressure field.

The Pipe Acoustics domain is connected to the second Pressure Acoustics domain (diaphragm cavity domain) through the Acoustics-Pipe Acoustics multiphysics coupling. This coupling guarantees continuity of pressure and velocity between both domains through the equations

$$p_{\text{pipe}} = \frac{1}{A} \int p_t dS \quad (2)$$

$$-\mathbf{n} \cdot \left( -\frac{1}{\rho} (\nabla p_t - \mathbf{q}_d) \right) = \frac{\partial u_{\text{pipe}}}{\partial t} \quad (3)$$

where  $p_{\text{pipe}}$  is the pipe pressure at the connection point,  $A$  is the total area of the connected acoustic boundary,  $p_t$  is the total pressure in the acoustic domain, and  $S$  is the connected acoustic boundary. Furthermore,  $\mathbf{n}$  is the vector normal to the boundary,  $\mathbf{q}_d$  is a dipole source, and  $u_{\text{pipe}}$  is the pipe velocity at the connection point.

---

**Note:** Further examples of coupling between 1D pipes and 3D domains are found in the tutorial model [Acoustics of a Pipe System with 3D Bend and Junction](http://www.comsol.com/model/acoustics-of-a-pipe-system-with-3d-bend-and-junction-40831), also available in the Application Gallery: [www.comsol.com/model/acoustics-of-a-pipe-system-with-3d-bend-and-junction-40831](http://www.comsol.com/model/acoustics-of-a-pipe-system-with-3d-bend-and-junction-40831).

---

### SOLVER SETUP

The only adjustment needed to be done to the solver is to change it from using a segregated approach to using a fully coupled approach. The default logic in the study is to use segregated groups for physics that do not have a built-in multiphysics coupling. Here, the coupling is set up manually in one of the ends of the pipe. The settings for the transient solver are handled automatically by setting the **Maximum frequency to resolve** in the **Transient Solver Settings** section (as done in the instructions below.)

## Reference

---

1. D.T. Blackstock, *Fundamentals of Physical Acoustics*, John Wiley & Sons, 2000.
- 

**Application Library path:** Pipe\_Flow\_Module/Pipe\_Acoustics/  
probe\_tube\_microphone

---

## Modeling Instructions



---

From the **File** menu, choose **New**.

### NEW

In the **New** window, click  **Model Wizard**.

### MODEL WIZARD

- 1 In the **Model Wizard** window, click  **3D**.
- 2 In the **Select Physics** tree, select **Acoustics>Pipe Acoustics>Pipe Acoustics, Transient (patd)**.
- 3 Click **Add**.
- 4 In the **Select Physics** tree, select **Acoustics>Pressure Acoustics>Pressure Acoustics, Transient (actd)**.
- 5 Click **Add**.
- 6 In the **Select Physics** tree, select **Acoustics>Pressure Acoustics>Pressure Acoustics, Transient (actd)**.
- 7 Click **Add**.
- 8 Click  **Study**.
- 9 In the **Select Study** tree, select **General Studies>Time Dependent**.
- 10 Click  **Done**.

### GLOBAL DEFINITIONS



#### Parameters I

- 1 In the **Model Builder** window, under **Global Definitions** click **Parameters I**.
- 2 In the **Settings** window for **Parameters**, locate the **Parameters** section.
- 3 Click  **Load from File**.



- 4 Browse to the model's Application Libraries folder and double-click the file `probe_tube_microphone_parameters.txt`.

## GEOMETRY I

Next, define the geometry of the model. Either build the geometry by following the instructions at the end of the document or import the geometry from a sequence, and then jump to the **Materials** section. To import the geometry sequence, click **Insert Sequence** in the **Geometry** toolbar. Browse to the model's Application Libraries folder and open the file `probe_tube_microphone_geom_sequence.mph`.

- 1 In the **Geometry** toolbar, click  **Insert Sequence**.
- 2 Browse to the model's Application Libraries folder and double-click the file `probe_tube_microphone_geom_sequence.mph`.
- 3 In the **Geometry** toolbar, click  **Build All**.

Use the wireframe rendering to more easily see and access faces and lines inside the geometry.

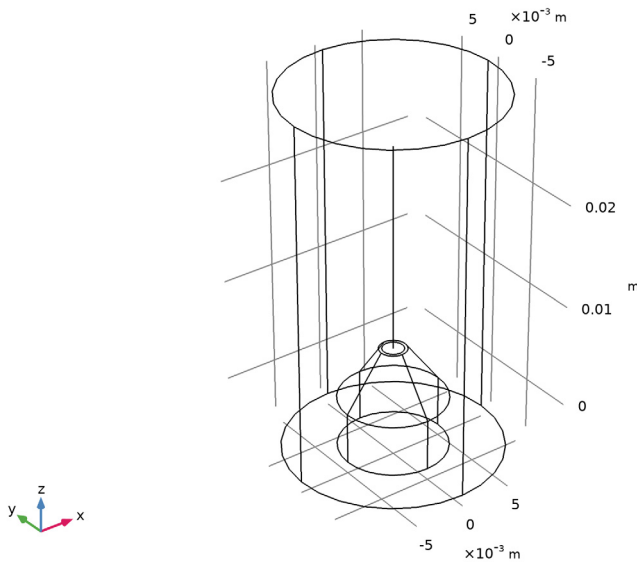

- 4 Click the  **Wireframe Rendering** button in the **Graphics** toolbar.
- 5 Click the  **Zoom Extents** button in the **Graphics** toolbar.

The geometry should look like the figure below.





## ADD MATERIAL

- 1 In the **Home** toolbar, click  **Add Material** to open the **Add Material** window.
- 2 Go to the **Add Material** window.
- 3 In the tree, select **Built-in>Air**.
- 4 Click **Add to Component** in the window toolbar.
- 5 In the tree, select **Built-in>Air**.
- 6 Click **Add to Component** in the window toolbar.
- 7 In the **Home** toolbar, click  **Add Material** to close the **Add Material** window.

## MATERIALS

### *Air 1 (mat2)*

- 1 In the **Settings** window for **Material**, locate the **Geometric Entity Selection** section.
- 2 From the **Geometric entity level** list, choose **Edge**.
- 3 Select Edge 25 only.

## DEFINITIONS

### *Average 1 (aveop1)*

- 1 In the **Definitions** toolbar, click  **Nonlocal Couplings** and choose **Average**.
- 2 In the **Settings** window for **Average**, type aveop\_mic in the **Operator name** text field.
- 3 Locate the **Source Selection** section. From the **Geometric entity level** list, choose **Boundary**.
- 4 Select Boundary 12 only.

### *Integration 1 (intop1)*

- 1 In the **Definitions** toolbar, click  **Nonlocal Couplings** and choose **Integration**.
- 2 In the **Settings** window for **Integration**, type intop\_tip in the **Operator name** text field.
- 3 Locate the **Source Selection** section. From the **Geometric entity level** list, choose **Point**.
- 4 Select Point 14 only.

## PIPE ACOUSTICS, TRANSIENT (PATD)

Proceed to set up the physics of the problem. Select the domains where the different physics are applied and add the appropriate boundary conditions to couple these.

- 1 In the **Model Builder** window, under **Component 1 (comp1)** click **Pipe Acoustics, Transient (patd)**.

- 2 In the **Settings** window for **Pipe Acoustics, Transient**, locate the **Edge Selection** section.
- 3 Click  **Clear Selection**.
- 4 Select Edge 25 only.

#### *Pipe Properties I*

- 1 In the **Model Builder** window, under **Component 1 (comp1)>Pipe Acoustics, Transient (patd)** click **Pipe Properties I**.
- 2 In the **Settings** window for **Pipe Properties**, locate the **Pipe Shape** section.
- 3 From the list, choose **Circular**.
- 4 In the  $d_i$  text field, type  $2 \cdot dr$ .
- 5 Locate the **Pipe Model** section. From the **Pipe model** list, choose **Anchored at one end**.
- 6 From the  $E$  list, choose **User defined**. In the associated text field, type  $0.1$  [GPa].
- 7 From the  $\nu$  list, choose **User defined**. In the associated text field, type  $0.4$ .
- 8 In the  $\Delta w$  text field, type  $dw$ .
- 9 In the **Model Builder** window, click **Pipe Acoustics, Transient (patd)**.
- 10 In the **Settings** window for **Pipe Acoustics, Transient**, locate the **Transient Solver Settings** section.
- 11 In the  $f_{\max, sol}$  text field, type  $f$ .

#### *Pressure I*

- 1 In the **Physics** toolbar, click  **Points** and choose **Pressure**.
- 2 Select Point 14 only.
- 3 In the **Settings** window for **Pressure**, locate the **Pressure** section.
- 4 In the  $p_{in}$  text field, type  $p2$ .

This manual coupling applies the pressure of the first Pressure Acoustics Domain into the Pipe Acoustics Domain.

#### **PRESSURE ACOUSTICS, TRANSIENT (ACTD)**

- 1 In the **Model Builder** window, under **Component 1 (comp1)** click **Pressure Acoustics, Transient (actd)**.
- 2 In the **Settings** window for **Pressure Acoustics, Transient**, locate the **Domain Selection** section.
- 3 Click  **Clear Selection**.
- 4 Select Domain 1 only.
- 5 Locate the **Transient Solver Settings** section. In the  $f_{\max, sol}$  text field, type  $f$ .

### Cylindrical Wave Radiation 1

- 1 In the **Physics** toolbar, click  **Boundaries** and choose **Cylindrical Wave Radiation**.
- 2 Select Boundaries 1, 2, 13, and 18 only.
- 3 In the **Settings** window for **Cylindrical Wave Radiation**, locate the **Cylindrical Wave Radiation** section.
- 4 Specify the  $\mathbf{r}_{\text{axis}}$  vector as

0	x
0	y
1	z

Add an incident plane wave as defined in [Equation 1](#) using the built-in **Plane wave (monochromatic)** option. The wave is automatically multiplied with a smoothing ramp function over the first period. This option can be seen by enabling the **Advanced Physics Options** view.

### Incident Pressure Field 1

- 1 In the **Physics** toolbar, click  **Attributes** and choose **Incident Pressure Field**.
- 2 In the **Settings** window for **Incident Pressure Field**, locate the **Incident Pressure Field** section.
- 3 In the  $p_0$  text field, type 1.
- 4 From the  $c$  list, choose **From material**.
- 5 From the **Material** list, choose **Air (mat1)**.
- 6 Specify the  $\mathbf{e}_k$  vector as

1	x
0	y
0	z

- 7 In the  $f_0$  text field, type f.

### PRESSURE ACOUSTICS, TRANSIENT 2 (ACTD2)

- 1 In the **Model Builder** window, under **Component 1 (comp1)** click **Pressure Acoustics, Transient 2 (actd2)**.
- 2 In the **Settings** window for **Pressure Acoustics, Transient**, locate the **Domain Selection** section.
- 3 Click  **Clear Selection**.

- 4 Select Domains 2 and 3 only.
- 5 Locate the **Transient Solver Settings** section. In the  $f_{\max, sol}$  text field, type  $f$ .

#### *Impedance 1*

- 1 In the **Physics** toolbar, click  **Boundaries** and choose **Impedance**.
- 2 Select Boundary 7 only.
- 3 In the **Settings** window for **Impedance**, locate the **Impedance** section.
- 4 In the  $Z_i$  text field, type  $100e6[N*s/m^5]*R^2*pi$ .

### **MULTIPHYSICS**

#### *Acoustic-Pipe Acoustic Connection 1 (apc1)*

- 1 In the **Physics** toolbar, click  **Multiphysics Couplings** and choose **Global>Acoustic-Pipe Acoustic Connection**.
- 2 In the **Settings** window for **Acoustic-Pipe Acoustic Connection**, locate the **Coupled Interfaces** section.
- 3 From the **Acoustics** list, choose **Pressure Acoustics, Transient 2 (actd2)**.  
Selecting this second **Pressure Acoustics** domain is important, as otherwise the probe will have both ends connected to the same domain.

### **MESH 1**

#### *Free Tetrahedral 1*

In the **Mesh** toolbar, click  **Free Tetrahedral**.

#### *Size*

- 1 In the **Model Builder** window, click **Size**.
- 2 In the **Settings** window for **Size**, locate the **Element Size** section.
- 3 Click the **Custom** button.
- 4 Locate the **Element Size Parameters** section. In the **Maximum element size** text field, type  $\lambda_{\min}/10$ .
- 5 In the **Minimum element size** text field, type  $dr/2$ .
- 6 In the **Resolution of narrow regions** text field, type 1.

#### *Free Tetrahedral 1*

- 1 In the **Model Builder** window, click **Free Tetrahedral 1**.
- 2 In the **Settings** window for **Free Tetrahedral**, locate the **Domain Selection** section.
- 3 From the **Geometric entity level** list, choose **Domain**.

4 Select Domains 2 and 3 only.

*Size 1*

- 1 Right-click **Free Tetrahedral 1** and choose **Size**.
- 2 In the **Settings** window for **Size**, locate the **Geometric Entity Selection** section.
- 3 From the **Geometric entity level** list, choose **Boundary**.
- 4 Select Boundary 12 only.
- 5 Locate the **Element Size** section. Click the **Custom** button.
- 6 Locate the **Element Size Parameters** section. Select the **Maximum element size** check box.
- 7 In the associated text field, type  $dr/2$ .
- 8 Click  **Build Selected**.

*Free Tetrahedral 2*

In the **Mesh** toolbar, click  **Free Tetrahedral**.

*Size 1*

- 1 Right-click **Free Tetrahedral 2** and choose **Size**.
- 2 In the **Settings** window for **Size**, locate the **Geometric Entity Selection** section.
- 3 From the **Geometric entity level** list, choose **Edge**.
- 4 Select Edge 25 only.
- 5 Locate the **Element Size** section. Click the **Custom** button.
- 6 Locate the **Element Size Parameters** section. Select the **Maximum element size** check box.
- 7 In the associated text field, type  $L/10$ .
- 8 Click  **Build All**.

**STUDY 1**

*Step 1: Time Dependent*

- 1 In the **Model Builder** window, under **Study 1** click **Step 1: Time Dependent**.
- 2 In the **Settings** window for **Time Dependent**, locate the **Study Settings** section.
- 3 In the **Output times** text field, type range  $(0, T/25, 5*T)$ .  
The data will be recorded for 5 periods ( $5*T$ ) with a sampling of 25 points per period (increase the number of points to get better resolution in the stored solution).

*Solution 1 (sol1)*

- 1 In the **Study** toolbar, click  **Show Default Solver**.
- 2 In the **Model Builder** window, expand the **Solution 1 (sol1)** node.

**3** In the **Model Builder** window, expand the **Study 1>Solver Configurations>Solution 1 (sol1)>Time-Dependent Solver 1** node.

**4** Right-click **Time-Dependent Solver 1** and choose **Fully Coupled**.

In this model, the coupling between the first Pressure Acoustics domain and the Pipe Acoustics Domain is set up manually. The default behavior, in the study, is for COMSOL to generate solver suggestions for the individual constituting physics (notice the tags) and sets up a segregated solver suggestion. This model is best solved using the fully coupled approach.

Now, solve the model and proceed to look at the results. First, look at the default plots and then create two custom plot groups. The model only takes a few seconds to solve.

**5** In the **Model Builder** window, under **Study 1>Solver Configurations>Solution 1 (sol1)>Time-Dependent Solver 1** click **Fully Coupled 1**.

**6** In the **Settings** window for **Fully Coupled**, click  **Compute**.

**RESULTS**

Acoustic Pressure (patd)

Time=0.01 s

Line: Pressure (Pa)

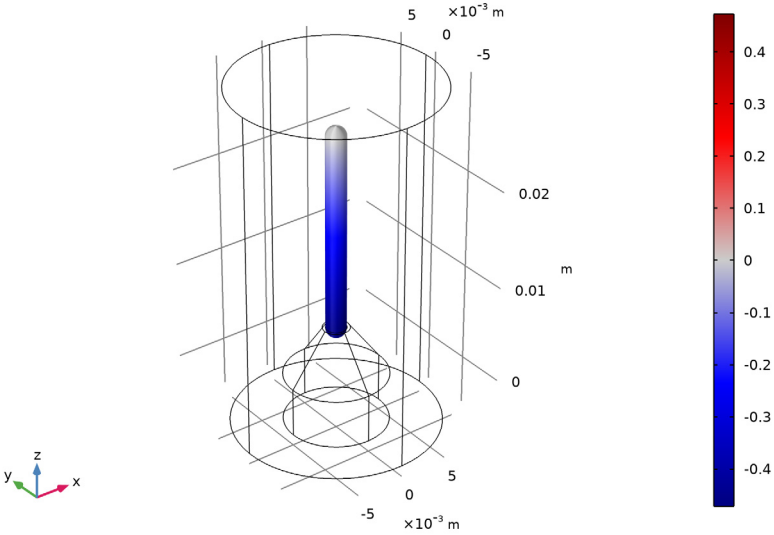

Acoustic Pressure (actd)

Time=0.01 s

Surface: Total acoustic pressure (Pa)

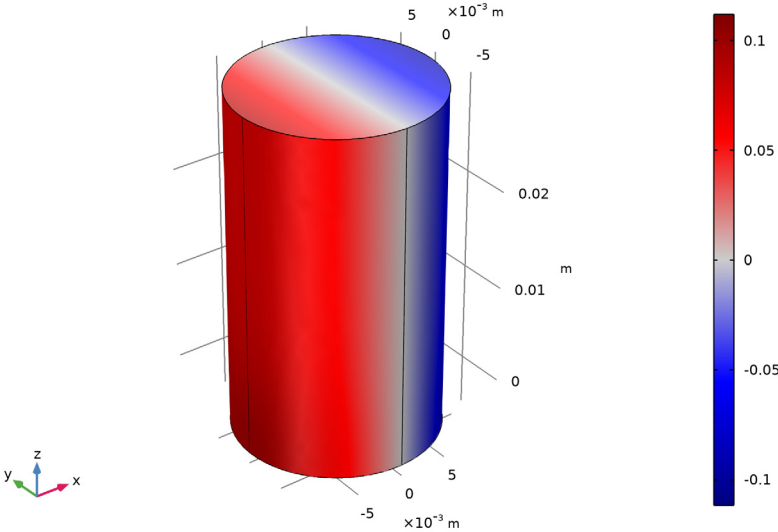

Acoustic Pressure, Isosurfaces (actd)

Time=0.01 s

Isosurface: Total acoustic pressure (Pa)

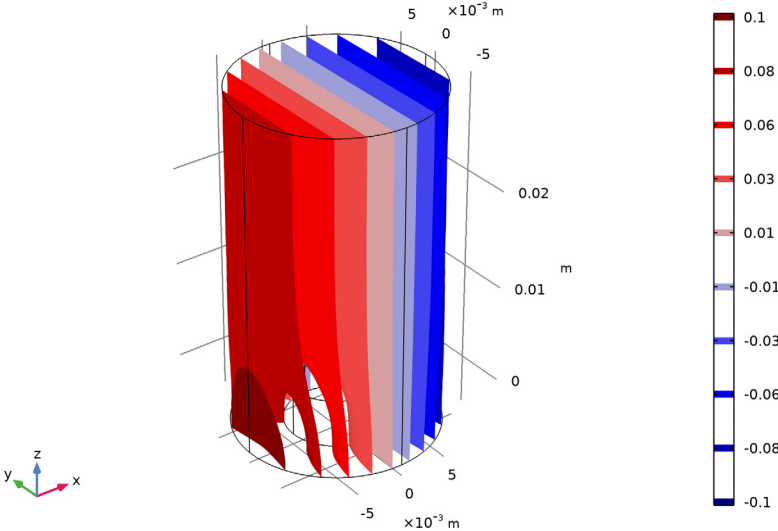



Acoustic Pressure (actd2)

Time=0.01 s

Surface: Total acoustic pressure (Pa)

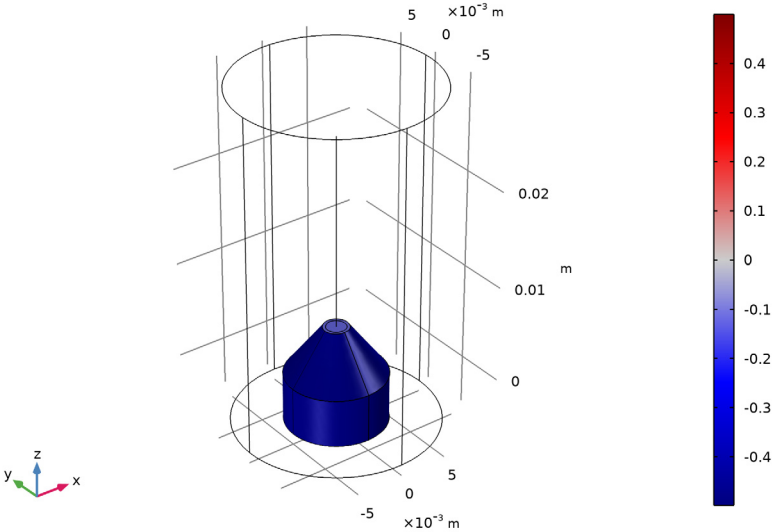

Acoustic Pressure, Isosurfaces (actd2)

Time=0.01 s

Isosurface: Total acoustic pressure (Pa)

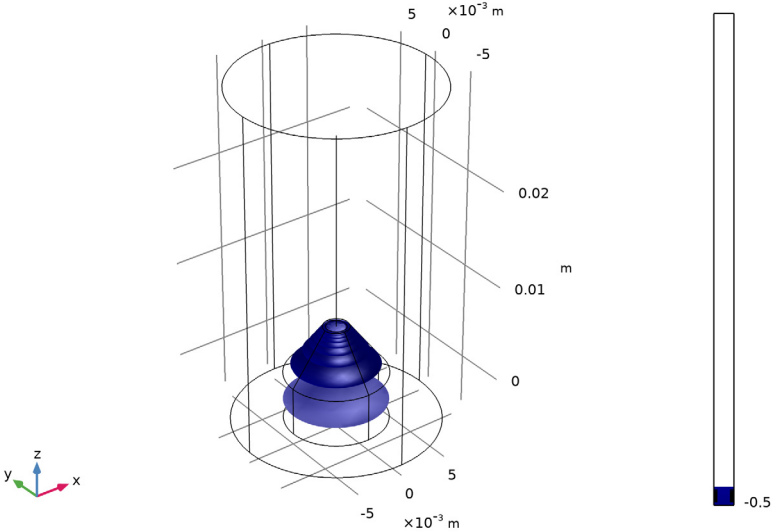

Follow the steps below to reproduce the plot in [Figure 3](#).

### *3D Plot Group 7*

In the **Home** toolbar, click  **Add Plot Group** and choose **3D Plot Group**.

#### *Slice 1*

- 1 Right-click **3D Plot Group 7** and choose **Slice**.
- 2 In the **Settings** window for **Slice**, locate the **Expression** section.
- 3 In the **Expression** text field, type `p2`.
- 4 Locate the **Plane Data** section. From the **Plane** list, choose **ZX-planes**.
- 5 In the **Planes** text field, type `1`.
- 6 Locate the **Coloring and Style** section. From the **Color table** list, choose **Wave**.
- 7 Select the **Symmetrize color range** check box.

#### *Slice 2*

- 1 In the **Model Builder** window, right-click **3D Plot Group 7** and choose **Slice**.
- 2 In the **Settings** window for **Slice**, locate the **Expression** section.
- 3 In the **Expression** text field, type `p3`.
- 4 Locate the **Plane Data** section. From the **Plane** list, choose **ZX-planes**.
- 5 In the **Planes** text field, type `1`.
- 6 Click to expand the **Inherit Style** section. From the **Plot** list, choose **Slice 1**.

#### *Line 1*

- 1 Right-click **3D Plot Group 7** and choose **Line**.
- 2 In the **Settings** window for **Line**, locate the **Coloring and Style** section.
- 3 From the **Line type** list, choose **Tube**.
- 4 In the **Tube radius expression** text field, type `0.5*patd.dh`.
- 5 Select the **Radius scale factor** check box.
- 6 Click to expand the **Inherit Style** section. From the **Plot** list, choose **Slice 1**.
- 7 In the **3D Plot Group 7** toolbar, click  **Plot**.

#### *Cross Sections*

- 1 In the **Model Builder** window, under **Results** click **3D Plot Group 7**.
- 2 In the **Settings** window for **3D Plot Group**, type `Cross Sections` in the **Label** text field.

The figure should look like the one depicted in [Figure 3](#).

### *ID Plot Group 8*

In the **Home** toolbar, click  **Add Plot Group** and choose **ID Plot Group**.

### *Global 1*

- 1 Right-click **ID Plot Group 8** and choose **Global**.
- 2 In the **Settings** window for **Global**, locate the **y-Axis Data** section.
- 3 In the table, enter the following settings:

Expression	Unit	Description
aveop_mic(p3)	Pa	Diaphragm Pressure
intop_tip(p)	Pa	Probe Tip Pressure

### *Pressure Profiles*

- 1 In the **Model Builder** window, click **ID Plot Group 8**.
- 2 In the **Settings** window for **ID Plot Group**, locate the **Plot Settings** section.
- 3 Select the **x-axis label** check box.
- 4 Select the **y-axis label** check box.
- 5 In the associated text field, type **Pressure (Pa)**.
- 6 In the **ID Plot Group 8** toolbar, click  **Plot**.
- 7 In the **Label** text field, type **Pressure Profiles**.

The figure should look like the one in [Figure 2](#).

## *Appendix: Geometry Sequence Instructions*

---



If you want to create the geometry yourself, follow these steps.

From the **File** menu, choose **New**.

### **NEW**

In the **New** window, click  **Model Wizard**.

### **MODEL WIZARD**

- 1 In the **Model Wizard** window, click  **3D**.
- 2 Click  **Done**.

## GLOBAL DEFINITIONS

### Parameters 1

- 1 In the **Model Builder** window, under **Global Definitions** click **Parameters 1**.
- 2 In the **Settings** window for **Parameters**, locate the **Parameters** section.
- 3 In the table, enter the following settings:

Name	Expression	Value	Description
L	20[mm]	0.02 m	Probe tube length
R	5[mm]	0.005 m	Microphone casing radius
H	5[mm]	0.005 m	Probe tube volume height
dr	1[mm]	0.001 m	Pipe inner radius
dw	0.3[mm]	3E-4 m	Pipe wall thickness

## GEOMETRY 1

### Cone 1 (cone1)

- 1 In the **Geometry** toolbar, click  **Cone**.
- 2 In the **Settings** window for **Cone**, locate the **Size and Shape** section.
- 3 In the **Bottom radius** text field, type R.
- 4 In the **Height** text field, type H.
- 5 In the **Top radius** text field, type dr+dw.

### Cylinder 1 (cyl1)

- 1 In the **Geometry** toolbar, click  **Cylinder**.
- 2 In the **Settings** window for **Cylinder**, locate the **Size and Shape** section.
- 3 In the **Radius** text field, type R.
- 4 In the **Height** text field, type H.
- 5 Locate the **Position** section. In the **z** text field, type -H.

### Polygon 1 (pol1)

- 1 In the **Geometry** toolbar, click  **More Primitives** and choose **Polygon**.
- 2 In the **Settings** window for **Polygon**, locate the **Coordinates** section.
- 3 From the **Data source** list, choose **Vectors**.
- 4 In the **x** text field, type 0 0.
- 5 In the **y** text field, type 0 0.

6 In the **z** text field, type  $H + H \cdot L$ .

*Cylinder 2 (cyl2)*

- 1 In the **Geometry** toolbar, click  **Cylinder**.
- 2 In the **Settings** window for **Cylinder**, locate the **Size and Shape** section.
- 3 In the **Radius** text field, type 10 [mm].
- 4 In the **Height** text field, type 35 [mm].
- 5 Locate the **Position** section. In the **z** text field, type -H.

*Work Plane 1 (wp1)*

- 1 In the **Geometry** toolbar, click  **Work Plane**.
- 2 In the **Settings** window for **Work Plane**, locate the **Plane Definition** section.
- 3 From the **Plane type** list, choose **Face parallel**.
- 4 On the object **cone1**, select Boundary 4 only.

*Work Plane 1 (wp1)>Plane Geometry*

In the **Model Builder** window, click **Plane Geometry**.

*Work Plane 1 (wp1)>Circle 1 (c1)*

- 1 In the **Work Plane** toolbar, click  **Circle**.
- 2 In the **Settings** window for **Circle**, locate the **Size and Shape** section.
- 3 In the **Radius** text field, type  $d \cdot r$ .
- 4 Click to expand the **Layers** section.

*Form Union (fin)*

In the **Home** toolbar, click  **Build All**.

