



Shape Memory Alloy Self-Expanding Stent

Introduction

This model studies an arterial stent made of shape memory alloy (SMA). The main benefit of SMA stents compared to usual metallic stents is their ability to self-expand, so they do not require the insertion and inflation of a balloon to give them the desired shape.

The SMA stent is manufactured with a diameter higher than the diameter of the destination artery. It is then crimped to the diameter of the artery at low temperature. Due to the low operating temperature, the material partially transforms from austenite to martensite at low stress levels. When the stent is inserted in the artery, its temperature increases to the human body temperature. Then the yield stress increases so the force applied by the stent on the inner wall of the artery increases.

Model Definition

The stent is made of 4 levels of SMA wire. Each level is made of 18 “V” sections (Figure 1). Thanks to symmetry and periodicity, only half of a “V” is modeled; that is, a 10 degrees sector (Figure 2).

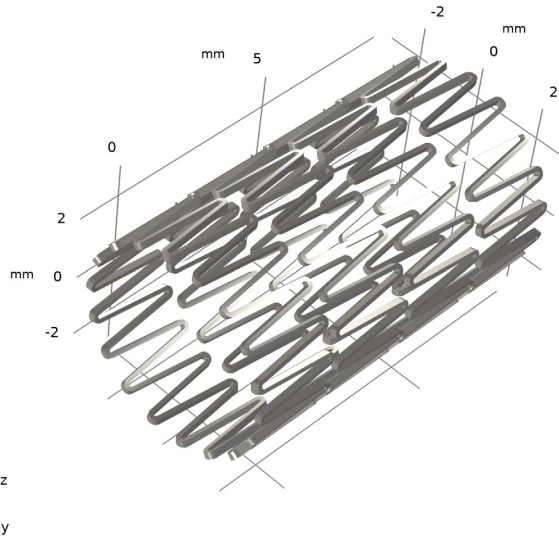

Figure 1: Entire geometry of the stent

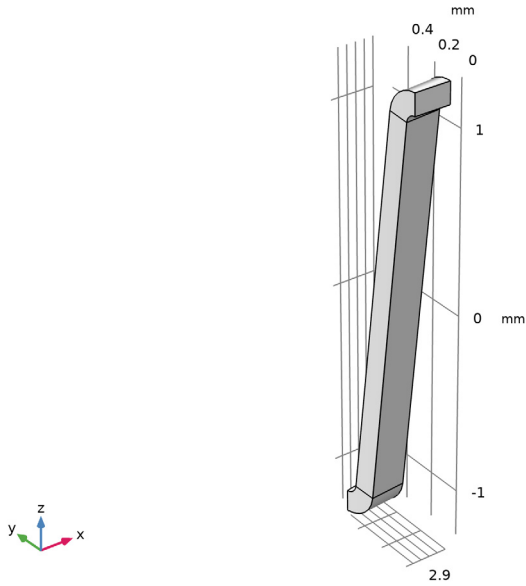

Figure 2: Geometry of the modeled domain of the stent.

The material is nickel-titanium alloy (nitinol), and it is modeled with Lagoudas SMA model. The material properties for each phase are given by:

TABLE 1: MATERIAL PROPERTIES OF EACH PHASE.

MATERIAL PROPERTY	AUSTENITE	MARTENSITE
Young's modulus	55 GPa	46 GPa
Poisson's ratio	0.33	0.33
Heat capacity at constant pressure	400 J/(kg.K)	400 J/(kg.K)
Density	6500 kg/m ³	6500 kg/m ³

The phase transformation parameters are:

TABLE 2: PHASE TRANSFORMATION PARAMETERS.

PARAMETER	VALUE
Martensite start temperature	-28 °C
Martensite finish temperature	-43 °C
Austenite start temperature	-3 °C

TABLE 2: PHASE TRANSFORMATION PARAMETERS.

PARAMETER	VALUE
Austenite finish temperature	7 °C
Slope of martensite limit curve	7.4 MPa/K
Slope of austenite limit curve	7.4 MPa/K
Maximum transformation strain	0.056

Results and Discussion

Figure 3 shows that after crimping the stress is concentrated at the inner face of the bend. The locations where the stress is maximal are the locations where the martensite volume fraction is higher as well. Nonzero martensite volume fraction means that transformation occurred, so residual strain remains. Comparison with Figure 4 shows that heating to body temperature has two effects: the maximum stress becomes far higher because the limit stress has increased, and the zone of transformation has reduced, which shows that reverse transformation has partially occurred. Those effects can be noticed on the figures of whole stent as well, see Figure 5 to Figure 8. The development of the martensite during the different steps of the solution is shown in Figure 9, and pressure on the inner wall of the artery during the release of the stent in Figure 10.

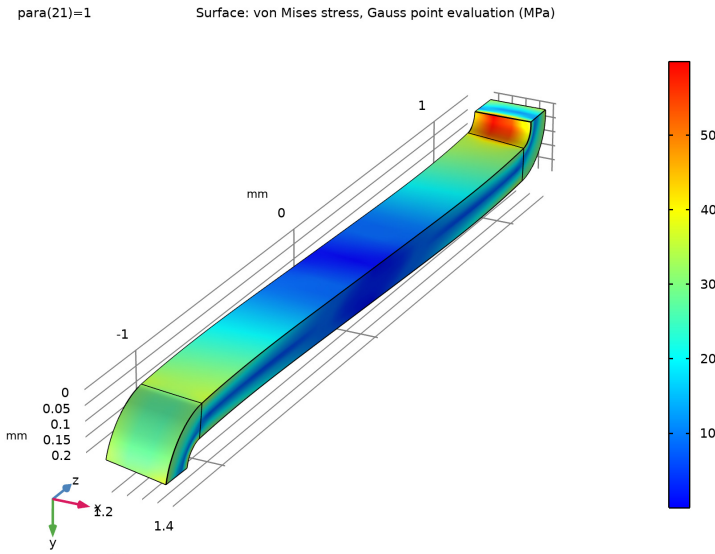

Figure 3: Stress and transformation state of one arm of the stent after crimping.

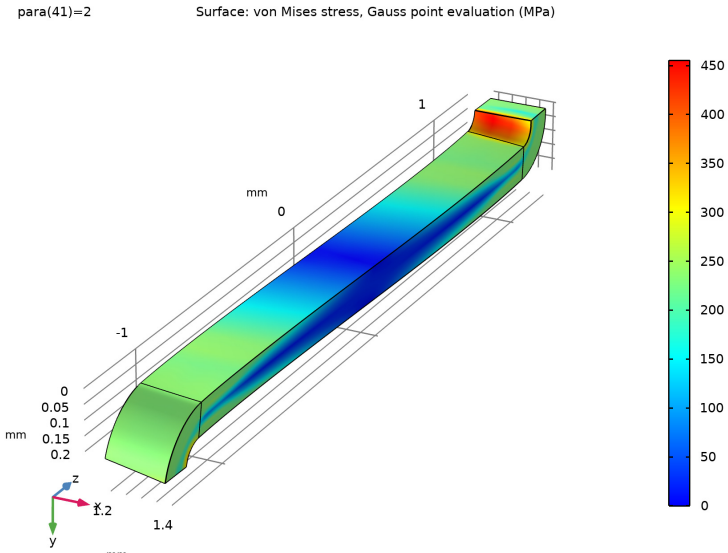

Figure 4: Stress and transformation state of one arm of the stent in the human body.

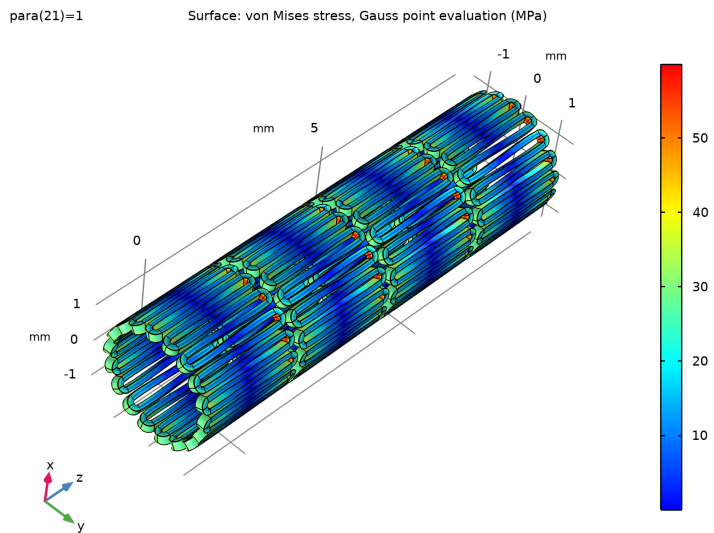

Figure 5: Stress in the stent after crimping.

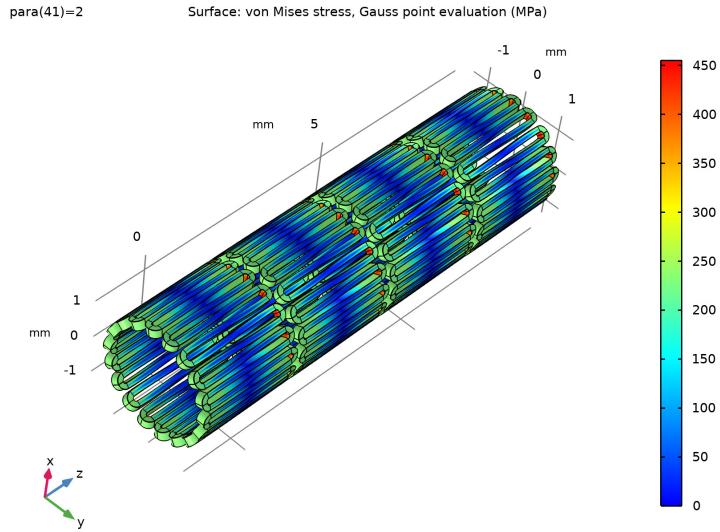

Figure 6: Stress in the stent in the human body.

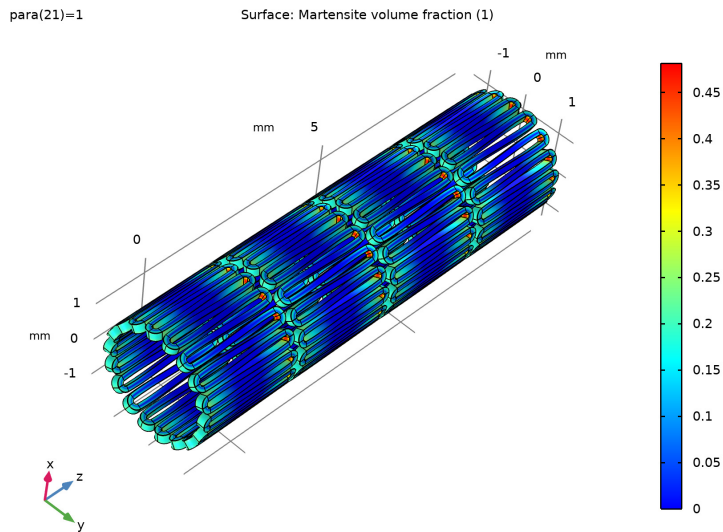

Figure 7: Martensite volume fraction in the stent after crimping.

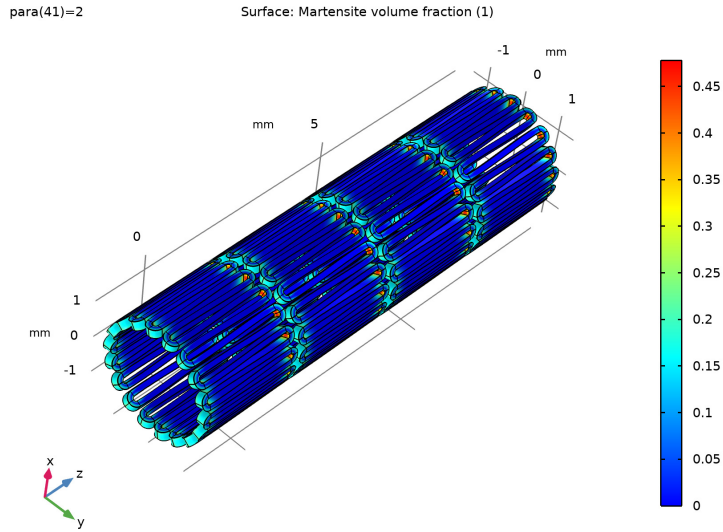

Figure 8: Martensite volume fraction in the stent in human body.

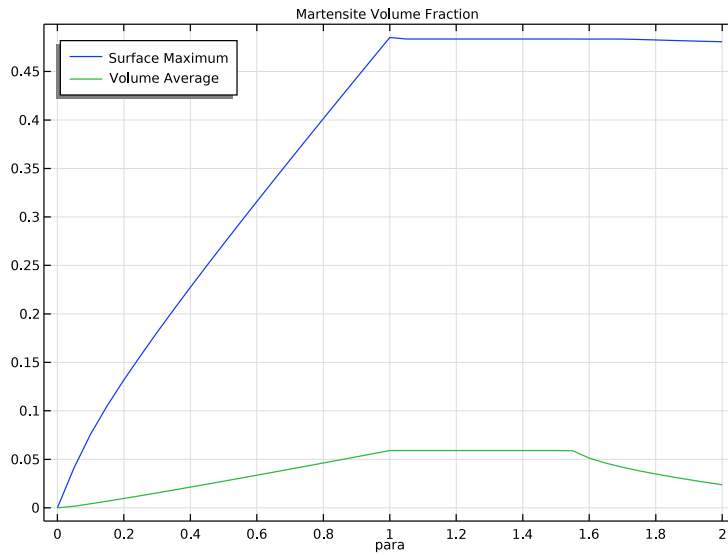

Figure 9: Maximum and average volume fraction history during crimping and release.

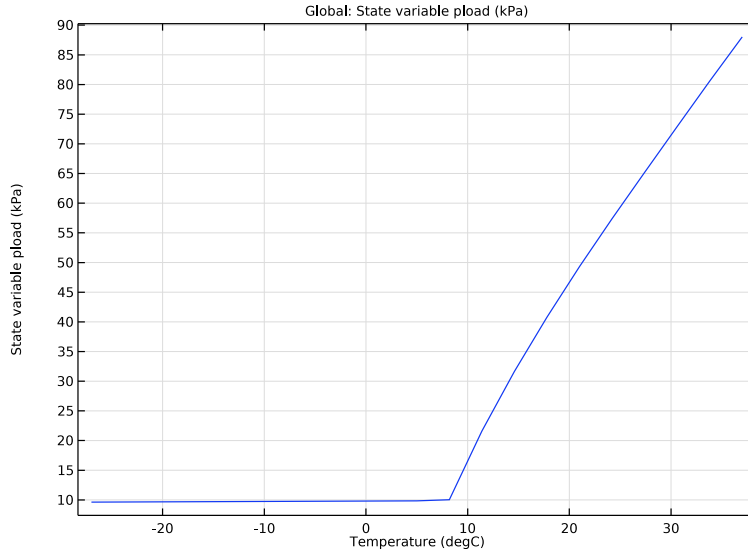

Figure 10: Pressure applied on the inner wall of the artery during stent release.

Notes About the COMSOL Implementation

The stent is crimped and maintained in position with a boundary load condition. The applied pressure is driven by the desired outer radius with a **Global Equations** feature. It adds the pressure as a DOF and adds a new global equation on the displacement.

Reference

1. D.C. Lagoudas, ed., *Shape Memory Alloys, Modeling and Engineering Applications*, Springer, p. 219, 2008.

Application Library path: Nonlinear_Structural_Materials_Module/
Shape_Memory_Alloys/sma_stent



Modeling Instructions

From the **File** menu, choose **New**.

NEW

In the **New** window, click  **Model Wizard**.

MODEL WIZARD

- 1 In the **Model Wizard** window, click  **3D**.
- 2 In the **Select Physics** tree, select **Structural Mechanics>Solid Mechanics (solid)**.
- 3 Click **Add**.
- 4 Click  **Study**.
- 5 In the **Select Study** tree, select **General Studies>Stationary**.
- 6 Click  **Done**.

GEOMETRY I

The geometry sequence for the model is available in a file. If you want to create it from scratch yourself, you can follow the instructions in the [Appendix — Geometry Modeling Instructions](#) section. Otherwise, insert the geometry sequence as follows:

- 1 In the **Geometry** toolbar, click  **Insert Sequence**.
- 2 Browse to the model's Application Libraries folder and double-click the file `sma_stent_geom_sequence.mph`.

3 In the **Geometry** toolbar, click  **Build All**.

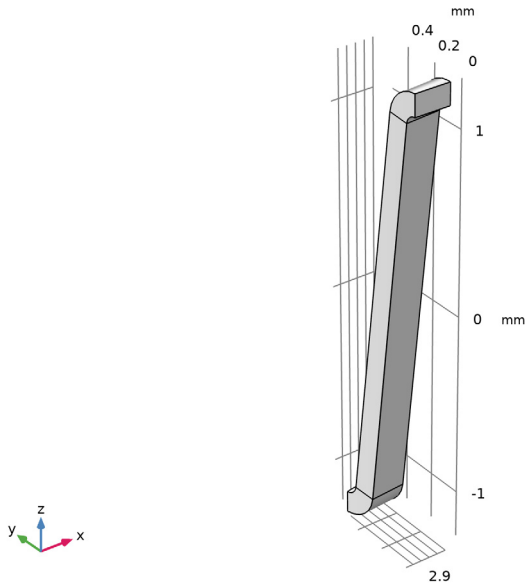

GLOBAL DEFINITIONS

Parameters 1

- 1 In the **Model Builder** window, under **Global Definitions** click **Parameters 1**.
- 2 In the **Settings** window for **Parameters**, locate the **Parameters** section.
- 3 In the table, enter the following settings:

Name	Expression	Value	Description
para	0	0	Sweep parameter
pload	0[N/m ²]	0 N/m ²	Applied pressure

DEFINITIONS

Add functions to prescribe the outer radius and temperature.

Interpolation 1 (int1)

- 1 In the **Home** toolbar, click  **Functions** and choose **Global>Interpolation**.
- 2 In the **Settings** window for **Interpolation**, locate the **Definition** section.
- 3 In the **Function name** text field, type ro.

4 In the table, enter the following settings:

t	f(t)
0	R ₀
1	1.4 [mm]
2	1.4 [mm]

5 Locate the **Units** section. In the **Function** text field, type m.

Interpolation 2 (int2)

1 In the **Home** toolbar, click **f(x) Functions** and choose **Global>Interpolation**.

2 In the **Settings** window for **Interpolation**, locate the **Definition** section.

3 In the **Function name** text field, type temperature.

4 In the table, enter the following settings:

t	f(t)
0	-27
1	-27
2	37

5 Locate the **Units** section. In the **Function** text field, type degC.

Since the study has two distinct phases, a first one with forward transformation and a second one with reverse transformation, use a function to specify the transformation direction. This will improve the time and robustness of computation.

Piecewise 1 (pw1)

1 In the **Home** toolbar, click **f(x) Functions** and choose **Global>Piecewise**.

2 In the **Settings** window for **Piecewise**, locate the **Definition** section.

3 Find the **Intervals** subsection. In the table, enter the following settings:

Start	End	Function
0	1	1
1	2	-1

Create three material nodes: one for each austenite and martensite phase, and one for common properties. For now, just add the material nodes to make them available, the required data will be filled in later.

MATERIALS

General

- 1 In the **Model Builder** window, under **Component 1 (comp1)** right-click **Materials** and choose **Blank Material**.
- 2 In the **Settings** window for **Material**, type General1 in the **Label** text field.

Austenite

- 1 Right-click **Materials** and choose **Blank Material**.
- 2 In the **Settings** window for **Material**, type Austenite in the **Label** text field.

Martensite

- 1 Right-click **Materials** and choose **Blank Material**.
- 2 In the **Settings** window for **Material**, type Martensite in the **Label** text field.

SOLID MECHANICS (SOLID)

Shape Memory Alloy 1

- 1 In the **Model Builder** window, under **Component 1 (comp1)** right-click **Solid Mechanics (solid)** and choose **Material Models>Shape Memory Alloy**.
- 2 In the **Settings** window for **Shape Memory Alloy**, locate the **Domain Selection** section.
- 3 From the **Selection** list, choose **All domains**.
- 4 Locate the **Model Input** section. From the *T* list, choose **User defined**. In the associated text field, type temperature(para).
- 5 Locate the **Shape Memory Alloy** section. Find the **Austenite** subsection. From the list, choose **Austenite (mat2)**.
- 6 Find the **Martensite** subsection. From the list, choose **Martensite (mat3)**.
- 7 Locate the **Geometric Nonlinearity** section. Select the **Force linear strains** check box.

Phase Transformation Direction 1

- 1 In the **Model Builder** window, expand the **Shape Memory Alloy 1** node, then click **Phase Transformation Direction 1**.
- 2 In the **Settings** window for **Phase Transformation Direction**, locate the **Phase Transformation Direction** section.
- 3 From the **Transformation direction** list, choose **User defined**.
- 4 In the text field, type pw1(para).

Shape Memory Alloy 1

In the **Model Builder** window, click **Shape Memory Alloy 1**.

Thermal Expansion 1

- 1 In the **Physics** toolbar, click  **Attributes** and choose **Thermal Expansion**.
- 2 In the **Settings** window for **Thermal Expansion**, locate the **Model Input** section.
- 3 Click  **Go to Source**.

GLOBAL DEFINITIONS

Default Model Inputs

- 1 In the **Model Builder** window, under **Global Definitions** click **Default Model Inputs**.
- 2 In the **Settings** window for **Default Model Inputs**, locate the **Browse Model Inputs** section.
- 3 Find the **Expression for remaining selection** subsection. In the **Volume reference temperature** text field, type $-27[\text{degC}]$.

SOLID MECHANICS (SOLID)

Thermal Expansion 1

- 1 In the **Model Builder** window, under **Component 1 (comp1)>Solid Mechanics (solid)>Shape Memory Alloy 1** click **Thermal Expansion 1**.
- 2 In the **Settings** window for **Thermal Expansion**, locate the **Thermal Expansion Properties** section.
- 3 Find the **Austenite** subsection. From the list, choose **Austenite (mat2)**.
- 4 Find the **Martensite** subsection. From the list, choose **Martensite (mat3)**.

Symmetry 1

- 1 In the **Physics** toolbar, click  **Boundaries** and choose **Symmetry**.
- 2 Select Boundaries 2 and 13 only.

Prescribe zero displacement in the z direction on one point to avoid rigid body motion.

Prescribed Displacement 1

- 1 In the **Physics** toolbar, click  **Points** and choose **Prescribed Displacement**.
- 2 Select Point 16 only.
- 3 In the **Settings** window for **Prescribed Displacement**, locate the **Prescribed Displacement** section.
- 4 Select the **Prescribed in z direction** check box.

Boundary Load 1

- 1 In the **Physics** toolbar, click  **Boundaries** and choose **Boundary Load**.
- 2 Select Boundaries 14–16 only.
- 3 In the **Settings** window for **Boundary Load**, locate the **Force** section.
- 4 From the **Load type** list, choose **Pressure**.
- 5 In the p text field, type `pload`.

DEFINITIONS

Use point integration to make the displacement available in expressions.

Integration 1 (`intop1`)

- 1 In the **Definitions** toolbar, click  **Nonlocal Couplings** and choose **Integration**.
- 2 In the **Settings** window for **Integration**, locate the **Advanced** section.
- 3 From the **Frame** list, choose **Material (X, Y, Z)**.
- 4 Locate the **Source Selection** section. From the **Geometric entity level** list, choose **Point**.
- 5 Select Point 16 only.

SOLID MECHANICS (SOLID)

Now add a global equation for the applied pressure, so that the outer radius equals the prescribed one. For that, you need to show advanced physics options.

- 1 Click the  **Show More Options** button in the **Model Builder** toolbar.
- 2 In the **Show More Options** dialog box, in the tree, select the check box for the node **Physics>Equation-Based Contributions**.
- 3 Click **OK**.

Global Equations 1

- 1 In the **Physics** toolbar, click  **Global** and choose **Global Equations**.
- 2 In the **Settings** window for **Global Equations**, locate the **Global Equations** section.
- 3 In the table, enter the following settings:

Name	$f(u, ut, utt, t)$ (l)	Initial value (u_0) (l)	Initial value (u_{t0}) (l/s)	Description
<code>pload</code>	<code>intop1(x) - ro(para)</code>	0	0	

- 4 Locate the **Units** section. Click  **Define Dependent Variable Unit**.

5 In the **Dependent variable quantity** table, enter the following settings:

Dependent variable quantity	Unit
Custom unit	Pa

6 Click  **Define Source Term Unit**.

7 In the **Source term quantity** table, enter the following settings:

Source term quantity	Unit
Custom unit	m

MATERIALS

General (mat1)

- 1 In the **Model Builder** window, under **Component 1 (comp1)>Materials** click **General (mat1)**.
- 2 In the **Settings** window for **Material**, locate the **Material Contents** section.
- 3 In the table, enter the following settings:

Property	Variable	Value	Unit	Property group
Shape memory alloy reference temperature	T0	293.15 [K]	K	Lagoudas model
Poisson's ratio	nu	0.33	I	Basic
Martensite start temperature	TM _s	-28 [degC]	K	Lagoudas model
Martensite finish temperature	TM _f	-43 [degC]	K	Lagoudas model
Slope of martensite limit curve	CM	7.4e6	Pa/K	Lagoudas model
Austenite start temperature	TA _s	-3 [degC]	K	Lagoudas model
Austenite finish temperature	TA _f	7 [degC]	K	Lagoudas model
Slope of austenite limit curve	CA	7.4e6	Pa/K	Lagoudas model
Maximum transformation strain	etrmaxLagoudas	0.056	I	Lagoudas model

Property	Variable	Value	Unit	Property group
Calibration stress level	sigmaStar	0	N/m ²	Lagoudas model
Density	rho	6500	kg/m ³	Basic

Austenite (mat2)

- 1 In the **Model Builder** window, click **Austenite (mat2)**.
- 2 In the **Settings** window for **Material**, locate the **Material Contents** section.
- 3 In the table, enter the following settings:

Property	Variable	Value	Unit	Property group
Young's modulus	E_A	55 [GPa]	Pa	Austenite phase
Heat capacity at constant pressure	Cp_A	400	J/(kg·K)	Austenite phase
Coefficient of thermal expansion	alpha_A_iso ; alpha_Aii = alpha_A_iso, alpha_Aij = 0	22e-6	1/K	Thermal expansion, austenite phase

Martensite (mat3)

- 1 In the **Model Builder** window, click **Martensite (mat3)**.
- 2 In the **Settings** window for **Material**, locate the **Material Contents** section.
- 3 In the table, enter the following settings:

Property	Variable	Value	Unit	Property group
Young's modulus	E_M	46 [GPa]	Pa	Martensite phase
Heat capacity at constant pressure	Cp_M	400	J/(kg·K)	Martensite phase
Coefficient of thermal expansion	alpha_M_iso ; alpha_Mii = alpha_M_iso, alpha_Mij = 0	22e-6	1/K	Thermal expansion, martensite phase

MESH 1

Mapped 1

- 1 In the **Mesh** toolbar, click  **Boundary** and choose **Mapped**.
- 2 Select Boundary 13 only.

Distribution 1

- 1 Right-click **Mapped 1** and choose **Distribution**.
- 2 Select Edge 16 only.
- 3 In the **Settings** window for **Distribution**, locate the **Distribution** section.
- 4 In the **Number of elements** text field, type 4.

Distribution 2

- 1 In the **Model Builder** window, right-click **Mapped 1** and choose **Distribution**.
- 2 Select Edge 18 only.
- 3 In the **Settings** window for **Distribution**, locate the **Distribution** section.
- 4 In the **Number of elements** text field, type 3.

Swept 1

In the **Mesh** toolbar, click  **Swept**.

Distribution 1

- 1 Right-click **Swept 1** and choose **Distribution**.
- 2 Select Domains 1 and 3 only.
- 3 In the **Settings** window for **Distribution**, locate the **Distribution** section.
- 4 In the **Number of elements** text field, type 20.

Distribution 2

- 1 In the **Model Builder** window, right-click **Swept 1** and choose **Distribution**.
- 2 In the **Settings** window for **Distribution**, locate the **Domain Selection** section.
- 3 Click  **Clear Selection**.
- 4 Select Domain 2 only.
- 5 Locate the **Distribution** section. From the **Distribution type** list, choose **Predefined**.
- 6 In the **Number of elements** text field, type 40.
- 7 In the **Element ratio** text field, type 8.
- 8 Select the **Symmetric distribution** check box.
- 9 In the **Model Builder** window, right-click **Mesh 1** and choose **Build All**.

Add maximum and average operators that will be used in postprocessing.

DEFINITIONS

Maximum I (maxopI)

- 1 In the **Definitions** toolbar, click  **Nonlocal Couplings** and choose **Maximum**.
- 2 In the **Settings** window for **Maximum**, locate the **Source Selection** section.
- 3 From the **Geometric entity level** list, choose **Boundary**.
- 4 Select Boundary 12 only.

Average I (aveopI)



- 1 In the **Definitions** toolbar, click  **Nonlocal Couplings** and choose **Average**.
- 2 In the **Settings** window for **Average**, locate the **Source Selection** section.
- 3 From the **Selection** list, choose **All domains**.
- 4 Locate the **Advanced** section. From the **Frame** list, choose **Material (X, Y, Z)**.

STUDY I

Step 1: Stationary

- 1 In the **Model Builder** window, under **Study I** click **Step 1: Stationary**.
- 2 In the **Settings** window for **Stationary**, locate the **Study Settings** section.
- 3 Select the **Include geometric nonlinearity** check box.
- 4 Click to expand the **Study Extensions** section. Select the **Auxiliary sweep** check box.
- 5 Click **+ Add**.
- 6 In the table, click to select the cell at row number 1 and column number 2.
- 7 In the table, enter the following settings:

Parameter name	Parameter value list	Parameter unit
para (Sweep parameter)		

- 8 Click  **Range**.
- 9 In the **Range** dialog box, type 0 in the **Start** text field.
- 10 In the **Step** text field, type 0.05.
- 11 In the **Stop** text field, type 2.
- 12 Click **Replace**.
- 13 In the **Home** toolbar, click  **Compute**.

RESULTS



Stress (solid)

- 1 In the **Settings** window for **3D Plot Group**, locate the **Plot Settings** section.
- 2 From the **Frame** list, choose **Spatial (x, y, z)**.

Surface I

- 1 In the **Model Builder** window, expand the **Stress (solid)** node, then click **Surface I**.
- 2 In the **Settings** window for **Surface**, locate the **Expression** section.
- 3 From the **Unit** list, choose **MPa**.

Stress (solid)

- 1 In the **Model Builder** window, click **Stress (solid)**.
- 2 In the **Settings** window for **3D Plot Group**, locate the **Plot Settings** section.
- 3 From the **View** list, choose **New view**.
- 4 In the **Stress (solid)** toolbar, click  **Plot**.
Use the mouse and zoom buttons to get similar view as [Figure 4](#).
Now show the results at the end of crimping.
- 5 Locate the **Data** section. From the **Parameter value (para)** list, choose **1**.
- 6 In the **Stress (solid)** toolbar, click  **Plot**.
- 7 From the **Parameter value (para)** list, choose **2**.

Reproduce [Figure 9](#) to show the evolution of martensite volume fraction.

Martensite Volume Fraction

- 1 In the **Home** toolbar, click  **Add Plot Group** and choose **ID Plot Group**.
- 2 In the **Settings** window for **ID Plot Group**, type Martensite Volume Fraction in the **Label** text field.

Global I

- 1 In the **Martensite Volume Fraction** toolbar, click  **Global**.
- 2 In the **Settings** window for **Global**, locate the **y-Axis Data** section.
- 3 In the table, enter the following settings:

Expression	Unit	Description
maxop1(solid.xi_M)	1	Surface Maximum
aveop1(solid.xi_M)	1	Volume Average

- 4 In the **Martensite Volume Fraction** toolbar, click  **Plot**.

Martensite Volume Fraction

- 1 In the **Model Builder** window, click **Martensite Volume Fraction**.
- 2 In the **Settings** window for **ID Plot Group**, click to expand the **Title** section.
- 3 From the **Title type** list, choose **Manual**.
- 4 In the **Title** text area, type Martensite Volume Fraction.
- 5 Locate the **Legend** section. From the **Position** list, choose **Upper left**.

Reproduce [Figure 10](#) to show the increase of pressure with temperature.

Pressure vs. Temperature

- 1 In the **Home** toolbar, click  **Add Plot Group** and choose **ID Plot Group**.
- 2 In the **Settings** window for **ID Plot Group**, type Pressure vs. Temperature in the **Label** text field.
- 3 Locate the **Data** section. From the **Parameter selection (para)** list, choose **From list**.
- 4 In the **Parameter values** list, select the solution steps from 1 to 2.

Global 1

- 1 Right-click **Pressure vs. Temperature** and choose **Global**.
- 2 In the **Settings** window for **Global**, locate the **y-Axis Data** section.
- 3 In the table, enter the following settings:

Expression	Unit	Description
pload	kPa	State variable pload

- 4 Locate the **x-Axis Data** section. From the **Parameter** list, choose **Expression**.
- 5 In the **Expression** text field, type temperature(para).
- 6 From the **Unit** list, choose **degC**.
- 7 Select the **Description** check box.
- 8 In the associated text field, type Temperature.

Pressure vs. Temperature

- 1 In the **Model Builder** window, click **Pressure vs. Temperature**.
- 2 In the **Settings** window for **ID Plot Group**, locate the **Legend** section.
- 3 Clear the **Show legends** check box.
- 4 In the **Pressure vs. Temperature** toolbar, click  **Plot**.

Create new datasets to build the entire geometry of the stent and reproduce [Figure 5](#) to [Figure 8](#).





Sector 3D 1

- 1 In the **Results** toolbar, click  **More Datasets** and choose **Sector 3D**.
- 2 In the **Settings** window for **Sector 3D**, locate the **Symmetry** section.
- 3 In the **Number of sectors** text field, type 2*Ns.
- 4 From the **Transformation** list, choose **Rotation and reflection**.

Array 3D 1

- 1 In the **Results** toolbar, click  **More Datasets** and choose **Array 3D**.
- 2 In the **Settings** window for **Array 3D**, locate the **Data** section.
- 3 From the **Dataset** list, choose **Sector 3D 1**.
- 4 Locate the **Array Size** section. In the **Z size** text field, type 4.
- 5 Locate the **Displacement** section. From the **Method** list, choose **Manual**.
- 6 In the **Z** text field, type $hs*1.1$.

Stress, Whole Stent

- 1 In the **Model Builder** window, right-click **Stress (solid)** and choose **Duplicate**.
- 2 In the **Settings** window for **3D Plot Group**, type **Stress, Whole Stent** in the **Label** text field.
- 3 Locate the **Data** section. From the **Dataset** list, choose **Array 3D 1**.
- 4 In the **Stress, Whole Stent** toolbar, click  **Plot**.
- 5 Locate the **Plot Settings** section. From the **View** list, choose **New view**.
- 6 In the **Stress, Whole Stent** toolbar, click  **Plot**.
- 7 Click  **Plot**.
- 8 Locate the **Data** section. From the **Parameter value (para)** list, choose **1**.
- 9 In the **Stress, Whole Stent** toolbar, click  **Plot**.
- 10 Click  **Plot**.
- 11 From the **Parameter value (para)** list, choose **2**.



Transformation, Whole Stent

- 1 Right-click **Stress, Whole Stent** and choose **Duplicate**.
- 2 In the **Settings** window for **3D Plot Group**, type **Transformation, Whole Stent** in the **Label** text field.

Surface 1

- 1 In the **Model Builder** window, expand the **Transformation, Whole Stent** node, then click **Surface 1**.
- 2 In the **Settings** window for **Surface**, click **Replace Expression** in the upper-right corner of the **Expression** section. From the menu, choose **Component 1 (comp1)>Solid Mechanics>Shape memory alloy>solid.xi_M - Martensite volume fraction**.

Transformation, Whole Stent

- 1 In the **Model Builder** window, click **Transformation, Whole Stent**.
- 2 In the **Transformation, Whole Stent** toolbar, click  **Plot**.
- 3 In the **Settings** window for **3D Plot Group**, locate the **Data** section.
- 4 From the **Parameter value (para)** list, choose 1.
- 5 In the **Transformation, Whole Stent** toolbar, click  **Plot**.
- 6 Click  **Plot**.
- 7 From the **Parameter value (para)** list, choose 2.

Create animations of the last two plots.

Stress

- 1 In the **Results** toolbar, click  **Animation** and choose **Player**.
- 2 In the **Settings** window for **Animation**, type Stress in the **Label** text field.
- 3 Locate the **Scene** section. From the **Subject** list, choose **Stress, Whole Stent**.
- 4 Locate the **Frames** section. From the **Frame selection** list, choose **All**.
- 5 Locate the **Playing** section. In the **Display each frame for** text field, type 0.2.
- 6 Right-click **Stress** and choose **Play**.

Transformation

- 1 Right-click **Stress** and choose **Duplicate**.
- 2 In the **Settings** window for **Animation**, type Transformation in the **Label** text field.
- 3 Locate the **Scene** section. From the **Subject** list, choose **Transformation, Whole Stent**.
- 4 Right-click **Transformation** and choose **Play**.

Appendix — Geometry Modeling Instructions

From the **File** menu, choose **New**.

NEW

In the **New** window, click  **Model Wizard**.

MODEL WIZARD

- 1 In the **Model Wizard** window, click  **3D**.
- 2 Click **Done**.

GLOBAL DEFINITIONS

Parameters 1

- 1 In the **Model Builder** window, under **Global Definitions** click **Parameters 1**.
- 2 In the **Settings** window for **Parameters**, locate the **Parameters** section.
- 3 In the table, enter the following settings:

Name	Expression	Value	Description
Ro	3[mm]	0.003 m	Outer radius
wr	0.2[mm]	2E-4 m	Width
Ri	Ro-wr	0.0028 m	Inner radius
hs	2.4[mm]	0.0024 m	Height
th	0.12[mm]	1.2E-4 m	Thickness
Ns	18	18	Number of sectors
alpha	2*pi/Ns/2[rad]	0.17453 rad	Sector angle
radius	0.12[mm]	1.2E-4 m	Bent radius

GEOMETRY 1

- 1 In the **Model Builder** window, under **Component 1 (comp1)** click **Geometry 1**.
- 2 In the **Settings** window for **Geometry**, locate the **Units** section.
- 3 From the **Length unit** list, choose **mm**.

Work Plane 1 (wpl)

- 1 In the **Geometry** toolbar, click  **Work Plane**.
- 2 In the **Settings** window for **Work Plane**, locate the **Plane Definition** section.
- 3 From the **Plane** list, choose **yz-plane**.



Work Plane 1 (wpl)>Plane Geometry

In the **Model Builder** window, click **Plane Geometry**.

Work Plane 1 (wp1)>Circle 1 (c1)

- 1 In the **Work Plane** toolbar, click  **Circle**.
- 2 In the **Settings** window for **Circle**, locate the **Object Type** section.
- 3 From the **Type** list, choose **Curve**.
- 4 Locate the **Size and Shape** section. In the **Radius** text field, type radius-th/2.
- 5 In the **Sector angle** text field, type 180.
- 6 Locate the **Position** section. In the **xw** text field, type $-Ri*\sin(\alpha/2)$.
- 7 In the **yw** text field, type $hs/2-radius$.
- 8 Locate the **Rotation Angle** section. In the **Rotation** text field, type 270.
- 9 Locate the **Selections of Resulting Entities** section. Select the **Resulting objects selection** check box.
- 10 From the **Show in 3D** list, choose **Off**.
- 11 Find the **Cumulative selection** subsection. Click **New**.
- 12 In the **New Cumulative Selection** dialog box, type union1 in the **Name** text field.
- 13 Click **OK**.

Work Plane 1 (wp1)>Circle 2 (c2)

- 1 In the **Work Plane** toolbar, click  **Circle**.
- 2 In the **Settings** window for **Circle**, locate the **Object Type** section.
- 3 From the **Type** list, choose **Curve**.
- 4 Locate the **Size and Shape** section. In the **Radius** text field, type radius+th/2.
- 5 In the **Sector angle** text field, type 180.
- 6 Locate the **Position** section. In the **xw** text field, type $Ri*\sin(\alpha/2)$.
- 7 In the **yw** text field, type $-(hs/2-radius)$.
- 8 Locate the **Rotation Angle** section. In the **Rotation** text field, type 90.
- 9 Locate the **Selections of Resulting Entities** section. Select the **Resulting objects selection** check box.
- 10 From the **Show in 3D** list, choose **Off**.
- 11 Find the **Cumulative selection** subsection. From the **Contribute to** list, choose **union1**.
- 12 Click  **Build Selected**.
- 13 Click the  **Zoom Extents** button in the **Graphics** toolbar.

Work Plane 1 (wp1)>Tangent 1 (tan1)

- 1 In the **Work Plane** toolbar, click  **Tangent**.

- 2 In the **Settings** window for **Tangent**, locate the **Tangent** section.
- 3 From the **Edge to tangent** list, choose **Circle 1**.
- 4 From the **Second edge to tangent** list, choose **Circle 2**.
- 5 Locate the **Selections of Resulting Entities** section. Find the **Cumulative selection** subsection. From the **Contribute to** list, choose **union1**.

Work Plane 1 (wp1)>Union 1 (uni1)

- 1 In the **Work Plane** toolbar, click  **Booleans and Partitions** and choose **Union**.
- 2 In the **Settings** window for **Union**, locate the **Union** section.
- 3 From the **Input objects** list, choose **union1**.

Work Plane 1 (wp1)>Circle 1 (c1), Work Plane 1 (wp1)>Circle 2 (c2), Work Plane 1 (wp1)>Tangent 1 (tan1), Work Plane 1 (wp1)>Union 1 (uni1)

In the **Model Builder** window, under **Component 1 (comp1)>Geometry 1>Work Plane 1 (wp1)>Plane Geometry**, Ctrl-click to select **Circle 1 (c1)**, **Circle 2 (c2)**, **Tangent 1 (tan1)**, and **Union 1 (uni1)**.

Work Plane 1 (wp1)>Circle 3 (c3)

- 1 Right-click and choose **Duplicate**.
- 2 In the **Settings** window for **Circle**, locate the **Size and Shape** section.
- 3 In the **Radius** text field, type $\text{radius} + \text{th}/2$.
- 4 Locate the **Selections of Resulting Entities** section. Find the **Cumulative selection** subsection. Click **New**.
- 5 In the **New Cumulative Selection** dialog box, type **union2** in the **Name** text field.
- 6 Click **OK**.

Work Plane 1 (wp1)>Circle 4 (c4)

- 1 In the **Model Builder** window, click **Circle 4 (c4)**.
- 2 In the **Settings** window for **Circle**, locate the **Size and Shape** section.
- 3 In the **Radius** text field, type $\text{radius} - \text{th}/2$.
- 4 Locate the **Selections of Resulting Entities** section. Find the **Cumulative selection** subsection. From the **Contribute to** list, choose **union2**.
- 5 Click  **Build Selected**.

Work Plane 1 (wp1)>Tangent 2 (tan2)

- 1 In the **Model Builder** window, click **Tangent 2 (tan2)**.
- 2 In the **Settings** window for **Tangent**, locate the **Tangent** section.

- 3 From the **Edge to tangent** list, choose **Circle 3**.
- 4 From the **Second edge to tangent** list, choose **Circle 4**.
- 5 Locate the **Selections of Resulting Entities** section. Find the **Cumulative selection** subsection. From the **Contribute to** list, choose **union2**.
- 6 Click  **Build Selected**.

Work Plane 1 (wp1)>Union 2 (uni2)

- 1 In the **Model Builder** window, click **Union 2 (uni2)**.
- 2 In the **Settings** window for **Union**, locate the **Union** section.
- 3 From the **Input objects** list, choose **union2**.
- 4 In the **Work Plane** toolbar, click  **Build All**.

Work Plane 1 (wp1)>Line Segment 1 (ls1)

- 1 In the **Work Plane** toolbar, click  **More Primitives** and choose **Line Segment**.
- 2 On the object **uni1**, select Point 4 only.
- 3 In the **Settings** window for **Line Segment**, locate the **Endpoint** section.
- 4 Find the **End vertex** subsection. Select the **Activate Selection** toggle button.
- 5 On the object **uni2**, select Point 4 only.

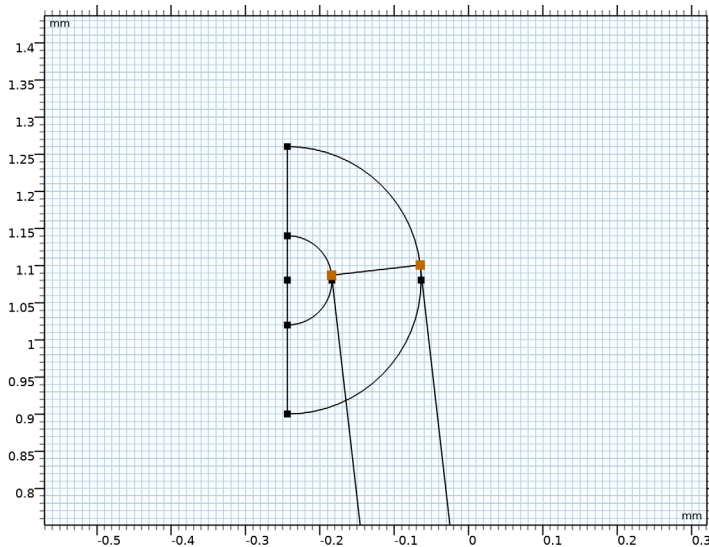

Work Plane 1 (wp1)>Line Segment 2 (ls2)

- 1 In the **Work Plane** toolbar, click  **More Primitives** and choose **Line Segment**.

- 2 On the object **uni1**, select Point 7 only.
- 3 In the **Settings** window for **Line Segment**, locate the **Endpoint** section.
- 4 Find the **End vertex** subsection. Select the **Activate Selection** toggle button.
- 5 On the object **uni2**, select Point 7 only.

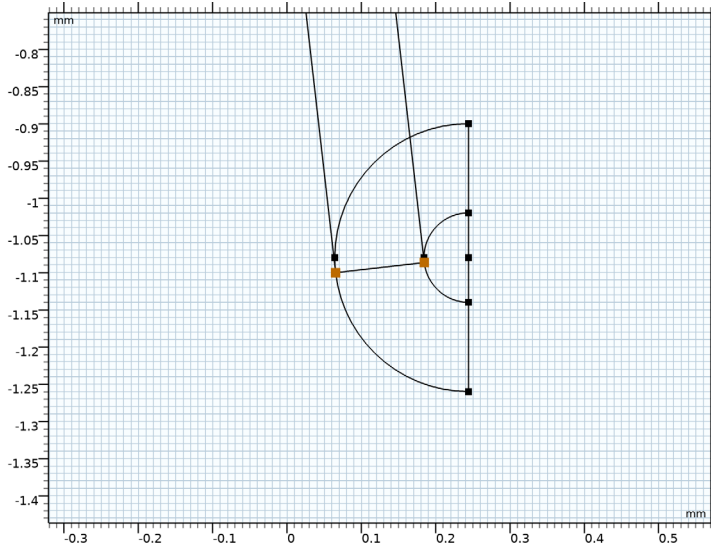

- 6 Click **Build Selected**.

Work Plane 1 (wp1)>Rectangle 1 (r1)

- 1 In the **Work Plane** toolbar, click **Rectangle**.
- 2 In the **Settings** window for **Rectangle**, locate the **Object Type** section.
- 3 From the **Type** list, choose **Curve**.
- 4 Locate the **Size and Shape** section. In the **Width** text field, type 0.2.
- 5 In the **Height** text field, type th.
- 6 Locate the **Position** section. From the **Base** list, choose **Center**.
- 7 In the **xw** text field, type $-(R_i \cdot \sin(\alpha/2) + 0.1)$.
- 8 In the **yw** text field, type $hs/2$.

Work Plane 1 (wp1)>Rectangle 2 (r2)

- 1 Right-click **Component 1 (comp1)>Geometry 1>Work Plane 1 (wp1)>Plane Geometry>Rectangle 1 (r1)** and choose **Duplicate**.
- 2 In the **Settings** window for **Rectangle**, locate the **Position** section.

3 In the **xw** text field, type $Ri*\sin(\alpha/2)+0.1$.

4 In the **yw** text field, type $-hs/2$.

Work Plane 1 (wp1)>Box Selection 1 (boxsel1)

1 In the **Work Plane** toolbar, click  **Selections** and choose **Box Selection**.

2 In the **Settings** window for **Box Selection**, locate the **Geometric Entity Level** section.

3 From the **Level** list, choose **Boundary**.

4 Locate the **Box Limits** section. In the **xw maximum** text field, type $-Ri*\sin(\alpha/2)+0.001$.

5 In the **yw maximum** text field, type $hs/2-th$.

6 Locate the **Resulting Selection** section. Find the **Cumulative selection** subsection. Click **New**.

7 In the **New Cumulative Selection** dialog box, type Delete in the **Name** text field.

8 Click **OK**.

Work Plane 1 (wp1)>Box Selection 2 (boxsel2)

1 In the **Work Plane** toolbar, click  **Selections** and choose **Box Selection**.

2 In the **Settings** window for **Box Selection**, locate the **Geometric Entity Level** section.

3 From the **Level** list, choose **Boundary**.

4 Locate the **Box Limits** section. In the **xw minimum** text field, type $Ri*\sin(\alpha/2)-0.001$.

5 In the **yw minimum** text field, type $-(hs/2-th)$.

6 Locate the **Resulting Selection** section. Find the **Cumulative selection** subsection. From the **Contribute to** list, choose **Delete**.

Work Plane 1 (wp1)>Disk Selection 1 (disksel1)

1 In the **Work Plane** toolbar, click  **Selections** and choose **Disk Selection**.

2 In the **Settings** window for **Disk Selection**, locate the **Geometric Entity Level** section.

3 From the **Level** list, choose **Boundary**.

4 Locate the **Input Entities** section. From the **Entities** list, choose **From selections**.

5 Click **+ Add**.

6 In the **Add** dialog box, in the **Selections** list, choose **Circle 1** and **Circle 3**.



7 Click **OK**.

8 In the **Settings** window for **Disk Selection**, locate the **Disk Center** section.

9 In the **xw** text field, type $-Ri*\sin(\alpha/2)$.

- 10 In the **yw** text field, type $hs/2$ -radius.
- 11 Locate the **Size and Shape** section. In the **Outer radius** text field, type radius+th.
- 12 In the **Inner radius** text field, type $1e-2$.
- 13 In the **Start angle** text field, type -15.
- 14 In the **End angle** text field, type 15.
- 15 Locate the **Output Entities** section. From the **Include entity if** list, choose **Entity inside disk**.
- 16 Locate the **Input Entities** section. In the **Selections** list, select **Circle 3**.
- 17 Locate the **Resulting Selection** section. Clear the **Keep selection** check box.
- 18 Find the **Cumulative selection** subsection. From the **Contribute to list**, choose **Delete**.

Work Plane 1 (wp1)>Disk Selection 2 (disksel2)

- 1 Right-click **Component 1 (comp1)>Geometry 1>Work Plane 1 (wp1)>Plane Geometry>Disk Selection 1 (disksel1)** and choose **Duplicate**.
- 2 In the **Settings** window for **Disk Selection**, locate the **Input Entities** section.
- 3 Click **Build Preceding State**.
- 4 In the **Selections** list, choose **Circle 1** and **Circle 3**.
- 5 Click  **Delete**.
- 6 Click  **Add**.
- 7 In the **Add** dialog box, in the **Selections** list, choose **Circle 2** and **Circle 4**.
- 8 Click **OK**.
- 9 In the **Settings** window for **Disk Selection**, locate the **Disk Center** section.
- 10 In the **xw** text field, type $Ri \cdot \sin(\alpha/2)$.
- 11 In the **yw** text field, type $-(hs/2$ -radius).
- 12 Locate the **Size and Shape** section. In the **Start angle** text field, type 165.
- 13 In the **End angle** text field, type 195.
- 14 Click  **Build Selected**.

Work Plane 1 (wp1)>Box Selection 3 (boxsel3)

- 1 In the **Work Plane** toolbar, click  **Selections** and choose **Box Selection**.
- 2 In the **Settings** window for **Box Selection**, locate the **Geometric Entity Level** section.
- 3 From the **Level** list, choose **Boundary**.
- 4 Locate the **Box Limits** section. In the **xw minimum** text field, type $-Ri \cdot \sin(\alpha/2) - 0.01$.

- 5 In the **xw maximum** text field, type $-R_i \sin(\alpha/2) + 0.01$.
- 6 Locate the **Output Entities** section. From the **Include entity if** list, choose **Entity inside box**.
- 7 Locate the **Resulting Selection** section. Find the **Cumulative selection** subsection. From the **Contribute to** list, choose **Delete**.
- 8 Clear the **Keep selection** check box.

Work Plane 1 (wp1)>Box Selection 4 (boxsel4)

- 1 Right-click **Component 1 (comp1)>Geometry 1>Work Plane 1 (wp1)>Plane Geometry>Box Selection 3 (boxsel3)** and choose **Duplicate**.
- 2 In the **Settings** window for **Box Selection**, locate the **Box Limits** section.
- 3 In the **xw minimum** text field, type $R_i \sin(\alpha/2) - 0.01$.
- 4 In the **xw maximum** text field, type $R_i \sin(\alpha/2) + 0.01$.

Work Plane 1 (wp1)>Delete Entities 1 (del1)

- 1 In the **Model Builder** window, right-click **Plane Geometry** and choose **Delete Entities**.
- 2 In the **Settings** window for **Delete Entities**, locate the **Entities or Objects to Delete** section.
- 3 From the **Selection** list, choose **Delete**.
- 4 Click  **Build Selected**.

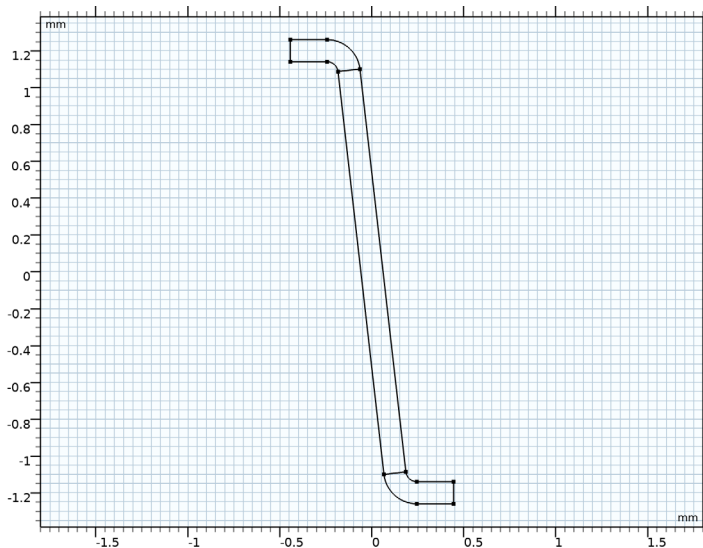

Work Plane 1 (wp1)>Convert to Solid 1 (csol1)

- 1 In the **Work Plane** toolbar, click  **Conversions** and choose **Convert to Solid**.

- 2 Click in the **Graphics** window and then press Ctrl+A to select all objects.
- 3 In the **Work Plane** toolbar, click  **Build All**.

Work Plane 1 (wp1)

In the **Model Builder** window, collapse the **Component 1 (comp1)>Geometry 1>Work Plane 1 (wp1)** node.

Extrude 1 (ext1)



- 1 In the **Model Builder** window, right-click **Geometry 1** and choose **Extrude**.
- 2 In the **Settings** window for **Extrude**, locate the **Distances** section.
- 3 In the table, enter the following settings:

Distances (mm)
Ro*1.1

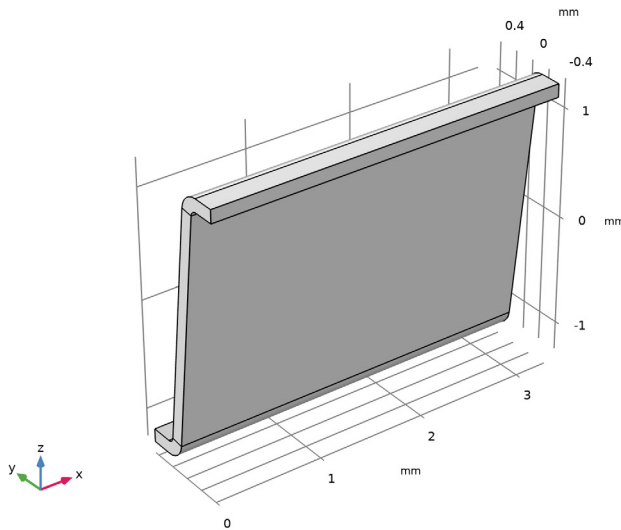
- 4 Click  **Build Selected**.



Rotate 1 (rot1)

- 1 In the **Geometry** toolbar, click  **Transforms** and choose **Rotate**.
- 2 Select the object **ext1** only.
- 3 In the **Settings** window for **Rotate**, locate the **Rotation** section.
- 4 In the **Angle** text field, type $\alpha/2$.
- 5 Click  **Build Selected**.



Work Plane 2 (wp2)

- 1 In the **Geometry** toolbar, click  **Work Plane**.
- 2 In the **Settings** window for **Work Plane**, locate the **Plane Definition** section.
- 3 From the **Plane** list, choose **xz-plane**.

Work Plane 2 (wp2)>Plane Geometry

In the **Model Builder** window, click **Plane Geometry**.

Work Plane 2 (wp2)>Rectangle 1 (r1)

- 1 In the **Work Plane** toolbar, click  **Rectangle**.
- 2 In the **Settings** window for **Rectangle**, locate the **Size and Shape** section.
- 3 In the **Width** text field, type wr .
- 4 In the **Height** text field, type $hs * 1.1$.
- 5 Locate the **Position** section. From the **Base** list, choose **Center**.
- 6 In the **xw** text field, type $(Ri+Ro) / 2$.
- 7 Click  **Build Selected**.

Work Plane 2 (wp2)

In the **Model Builder** window, collapse the **Component 1 (comp1)>Geometry 1>Work Plane 2 (wp2)** node.

Revolve 1 (rev1)

- 1 In the **Model Builder** window, right-click **Geometry 1** and choose **Revolve**.
- 2 In the **Settings** window for **Revolve**, locate the **Revolution Angles** section.
- 3 Click the **Angles** button.
- 4 In the **End angle** text field, type α .

5 Click  **Build Selected.**

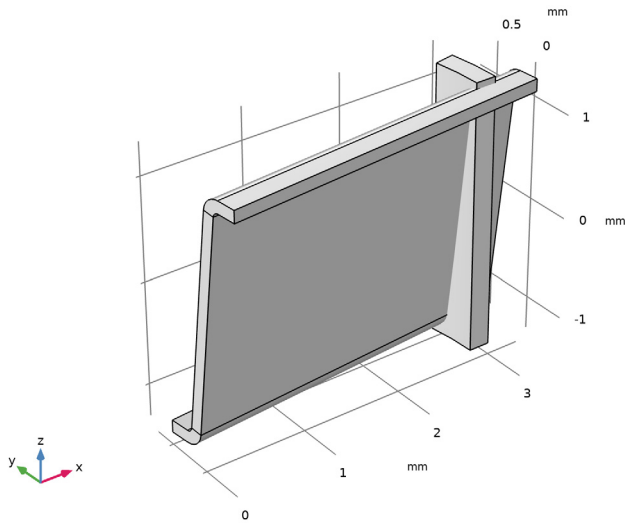

Intersection I (intI)

- 1 In the **Geometry** toolbar, click  **Booleans and Partitions** and choose **Intersection**.
- 2 Click in the **Graphics** window and then press Ctrl+A to select both objects.

Ignore Edges I (igeI)

- 1 In the **Geometry** toolbar, click  **Virtual Operations** and choose **Ignore Edges**.

2 On the object **fin**, select Edges 4, 7, 19, and 21 only.

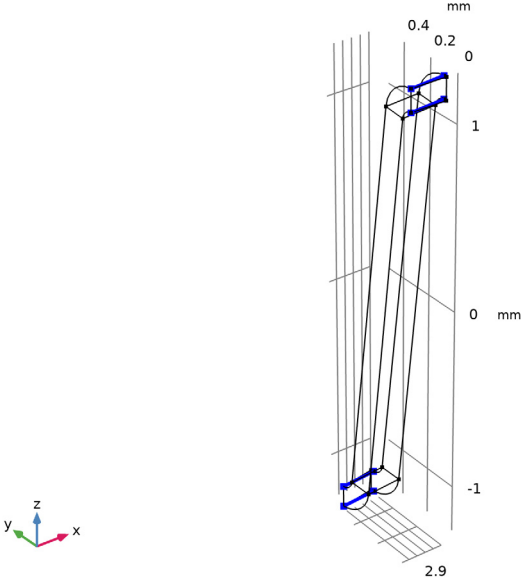

3 In the **Geometry** toolbar, click  **Build All**.

4 Click the  **Go to Default View** button in the **Graphics** toolbar.