



# Nonisothermal MEMS Heat Exchanger

## Introduction

---

The following example builds and solves a conduction and convection heat transfer problem using the Nonisothermal Flow multiphysics coupling.

The example concerns a stainless-steel MEMS heat exchanger, which you can find in lab-on-a-chip devices in biotechnology and in microreactors such as for micro fuel cells. This application examines the heat exchanger in 3D, and it involves heat transfer through both convection and conduction.

## Model Definition — Heat Exchanger

---

Figure 1 shows the geometry of the heat exchanger. It is necessary to model only one unit cell because they are all almost identical except for edge effects in the outer cells.

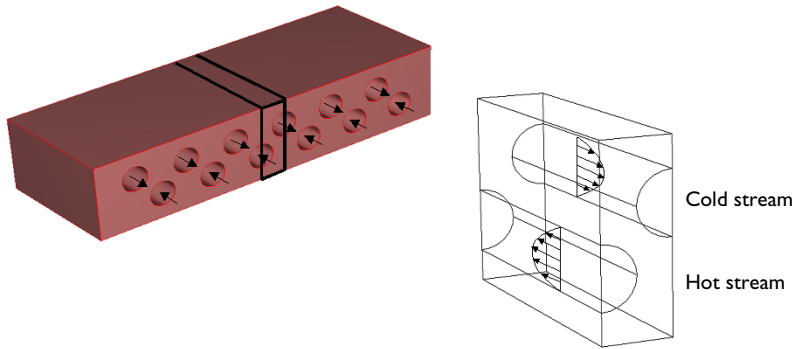

Figure 1: Depiction of the modeled part of the heat exchanger (left).

The governing equation for this model is the heat equation for conductive and convective heat transfer

$$\rho C_p \mathbf{u} \cdot \nabla T + \nabla \cdot (-k \nabla T) = Q$$

where  $C_p$  denotes the specific heat capacity (SI unit: J/(kg·K)),  $T$  is the temperature (SI unit: K),  $k$  is the thermal conductivity (SI unit: W/(m·K)),  $\rho$  is the density (SI unit: kg/m<sup>3</sup>),  $\mathbf{u}$  is the velocity vector (SI unit: m/s), and  $Q$  is a sink or source term (which you set to zero because there is no production or consumption of heat in the device).

In the solid part of the heat exchanger the velocity is zero. In the channels the velocity field is determined using the Laminar Flow interface. With the Nonisothermal Flow

multiphysics coupling the flow computation also takes density and viscosity variations due to varying temperature into account.

The boundary conditions for heat transfer are insulating for all outer surfaces except for the inlet and outlet boundaries in the fluid channels. At the inlets, you specify constant temperatures for the cold and hot streams,  $T_{\text{cold}}$  and  $T_{\text{hot}}$ , respectively. At the outlets, convection dominates the transport of heat so you apply the convective flux boundary condition:

$$-k\nabla T \cdot \mathbf{n} = 0$$

At the channel walls the velocity is zero. At the inlets a laminar velocity profile with an average velocity of 2.5 mm/s is applied. At the outlets where heat transport is dominated by convection the outlet boundary condition applies a constant pressure.

### *Results and Discussion*

---

[Figure 2](#) shows the temperature isosurfaces and the heat flux streamlines for the conductive heat flux in the device. The temperature isosurfaces clearly show the convective term's influence in the channels. [Figure 3](#) displays the corresponding results for the extended application. As the plot shows, the temperature distribution is very similar to that

in the first study, which can therefore be concluded to be a good approximation of the extended case.

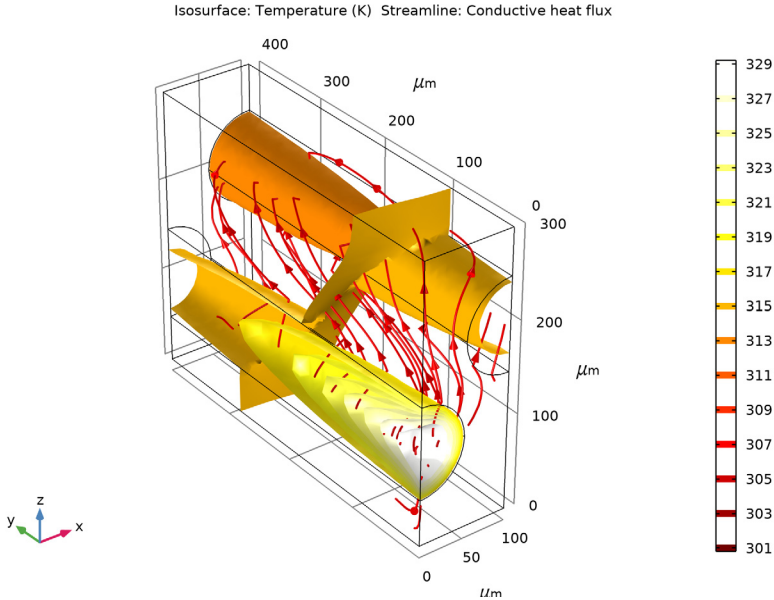

Figure 2: Isotherms and conductive heat flux streamlines in the cell unit's geometry.

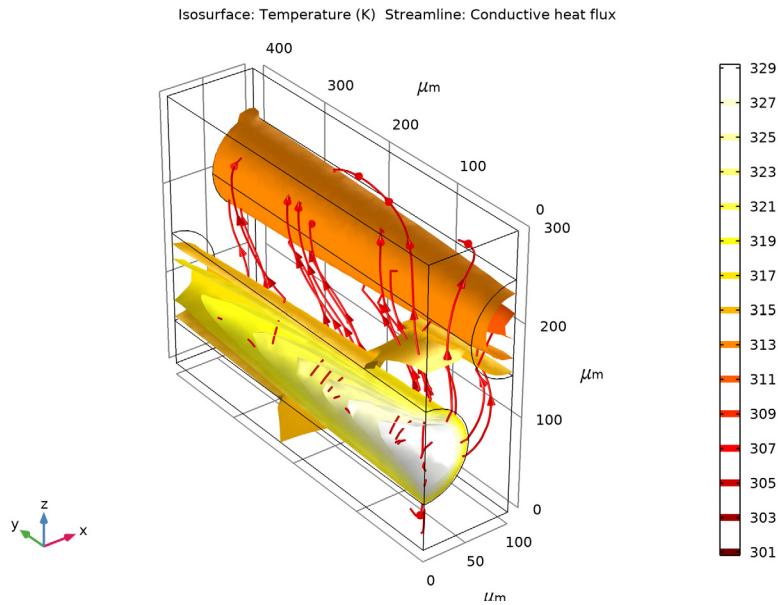

Figure 3: Extended application results; isotherms and conductive heat flux streamlines in the cell unit's geometry.

---

**Application Library path:** Heat\_Transfer\_Module/Heat\_Exchangers/  
heat\_exchanger\_ni

---

### *Modeling Instruction*

---



From the **File** menu, choose **New**.

#### **NEW**

In the **New** window, click  **Model Wizard**.

#### **MODEL WIZARD**

- 1** In the **Model Wizard** window, click  **3D**.
- 2** In the **Select Physics** tree, select **Fluid Flow>Nonisothermal Flow>Laminar Flow**.
- 3** Click **Add**.

- 4 Click  **Study**.
- 5 In the **Select Study** tree, select **General Studies>Stationary**.
- 6 Click  **Done**.

## GLOBAL DEFINITIONS

### Parameters 1



- 1 In the **Model Builder** window, under **Global Definitions** click **Parameters 1**.
- 2 In the **Settings** window for **Parameters**, locate the **Parameters** section.
- 3 In the table, enter the following settings:

Name	Expression	Value	Description
R	50[um]	5E-5 m	Channel radius
v_mean	50[mm/s]	0.05 m/s	Mean velocity
T_hot	330[K]	330 K	Temperature, hot channel
T_cold	300[K]	300 K	Temperature, cold channel
T_mean	(T_hot+T_cold)/2	315 K	Mean temperature
rho_mean_w	1000[kg/m^3]	1000 kg/m <sup>3</sup>	Fluid mean density

## GEOMETRY 1

- 1 In the **Model Builder** window, under **Component 1 (comp1)** click **Geometry 1**.
- 2 In the **Settings** window for **Geometry**, locate the **Units** section.
- 3 From the **Length unit** list, choose **µm**.

### Block 1 (blk1)



- 1 In the **Geometry** toolbar, click  **Block**.
- 2 In the **Settings** window for **Block**, locate the **Size and Shape** section.
- 3 In the **Width** text field, type 100.
- 4 In the **Depth** text field, type 400.
- 5 In the **Height** text field, type 300.
- 6 In the **Geometry** toolbar, click  **Build All**.

### Cylinder 1 (cyl1)



- 1 In the **Geometry** toolbar, click  **Cylinder**.
- 2 In the **Settings** window for **Cylinder**, locate the **Size and Shape** section.

- 3 In the **Radius** text field, type R.
- 4 In the **Height** text field, type 400.
- 5 Locate the **Position** section. In the **z** text field, type 2\*R.
- 6 Locate the **Axis** section. From the **Axis type** list, choose **y-axis**.
- 7 In the **Geometry** toolbar, click  **Build All**.

*Copy 1 (copy1)*

- 1 In the **Geometry** toolbar, click  **Transforms** and choose **Copy**.
- 2 Select the object **cy11** only.
- 3 In the **Settings** window for **Copy**, locate the **Displacement** section.
- 4 In the **x** text field, type 2\*R.
- 5 In the **z** text field, type 2\*R.
- 6 In the **Geometry** toolbar, click  **Build All**.

*Compose 1 (col)*

- 1 In the **Geometry** toolbar, click  **Booleans and Partitions** and choose **Compose**.
- 2 Click in the **Graphics** window and then press Ctrl+A to select all objects.
- 3 In the **Settings** window for **Compose**, locate the **Compose** section.
- 4 In the **Set formula** text field, type  $\text{blk1} * (\text{cy11} + \text{copy1}) + \text{blk1}$ .
- 5 In the **Geometry** toolbar, click  **Build All**.

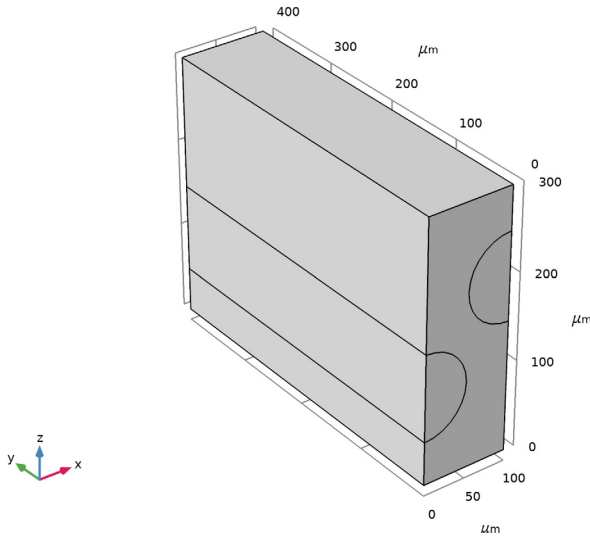

Define some selections that will be useful during the model set-up.

## DEFINITIONS

### *Solid*

- 1 In the **Definitions** toolbar, click  **Explicit**.
- 2 In the **Settings** window for **Explicit**, type Solid in the **Label** text field.
- 3 Select Domain 1 only.

### *Hot Channel*

- 1 In the **Definitions** toolbar, click  **Explicit**.
- 2 In the **Settings** window for **Explicit**, type Hot Channel in the **Label** text field.
- 3 Select Domain 2 only.

### *Cold Channel*

- 1 In the **Definitions** toolbar, click  **Explicit**.
- 2 In the **Settings** window for **Explicit**, type Cold Channel in the **Label** text field.
- 3 Select Domain 3 only.

### *Channels*

- 1 In the **Definitions** toolbar, click  **Union**.
- 2 In the **Settings** window for **Union**, type Channels in the **Label** text field.
- 3 Locate the **Input Entities** section. Under **Selections to add**, click **+ Add**.
- 4 In the **Add** dialog box, in the **Selections to add** list, choose **Hot Channel** and **Cold Channel**.
- 5 Click **OK**.

### *Channel Walls*

- 1 In the **Definitions** toolbar, click  **Adjacent**.
- 2 In the **Settings** window for **Adjacent**, type Channel Walls in the **Label** text field.
- 3 Locate the **Input Entities** section. Under **Input selections**, click **+ Add**.
- 4 In the **Add** dialog box, in the **Input selections** list, choose **Solid** and **Channels**.
- 5 Click **OK**.
- 6 In the **Settings** window for **Adjacent**, locate the **Output Entities** section.
- 7 Clear the **Exterior boundaries** check box.
- 8 Select the **Interior boundaries** check box.





### Variables 1

- 1 In the **Definitions** toolbar, click  **Local Variables**.
- 2 In the **Settings** window for **Variables**, locate the **Geometric Entity Selection** section.
- 3 From the **Geometric entity level** list, choose **Domain**.
- 4 From the **Selection** list, choose **Channels**.
- 5 Locate the **Variables** section. In the table, enter the following settings:

Name	Expression	Unit	Description
rho_w	$\rho_{\text{mean}_w} * (1 - (T - T_{\text{mean}}) / T_{\text{mean}})$	kg/m <sup>3</sup>	Fluid density

### ADD MATERIAL

- 1 In the **Home** toolbar, click  **Add Material** to open the **Add Material** window.
- 2 Go to the **Add Material** window.
- 3 In the tree, select **Built-in>Steel AISI 4340**.
- 4 Click **Add to Component** in the window toolbar.
- 5 In the tree, select **Built-in>Water, liquid**.
- 6 Click **Add to Component** in the window toolbar.
- 7 In the **Home** toolbar, click  **Add Material** to close the **Add Material** window.

### MATERIALS

#### Steel AISI 4340 (mat1)

- 1 In the **Model Builder** window, under **Component 1 (comp1)>Materials** click **Steel AISI 4340 (mat1)**.
- 2 In the **Settings** window for **Material**, locate the **Geometric Entity Selection** section.
- 3 From the **Selection** list, choose **Solid**.

#### Water, liquid (mat2)

- 1 In the **Model Builder** window, click **Water, liquid (mat2)**.
- 2 In the **Settings** window for **Material**, locate the **Geometric Entity Selection** section.
- 3 From the **Selection** list, choose **Channels**.

### HEAT TRANSFER IN FLUIDS (HT)

#### Fluid 1

- 1 In the **Model Builder** window, under **Component 1 (comp1)>Heat Transfer in Fluids (ht)** click **Fluid 1**.

- 2 In the **Settings** window for **Fluid**, locate the **Thermodynamics, Fluid** section.
- 3 From the **Fluid type** list, choose **Gas/Liquid**.
- 4 From the  $\rho$  list, choose **User defined**. In the associated text field, type  $\rho_w$ .
- 5 From the  $\gamma$  list, choose **User defined**.

#### *Solid 1*

- 1 In the **Physics** toolbar, click  **Domains** and choose **Solid**.
- 2 In the **Settings** window for **Solid**, locate the **Domain Selection** section.
- 3 From the **Selection** list, choose **Solid**.

### **LAMINAR FLOW (SPF)**

- 1 In the **Model Builder** window, under **Component 1 (comp1)** click **Laminar Flow (spf)**.
- 2 In the **Settings** window for **Laminar Flow**, locate the **Domain Selection** section.
- 3 From the **Selection** list, choose **Channels**.

#### *Inlet 1*

- 1 In the **Physics** toolbar, click  **Boundaries** and choose **Inlet**.
- 2 Select Boundary 5 only.
- 3 In the **Settings** window for **Inlet**, locate the **Boundary Condition** section.
- 4 From the list, choose **Fully developed flow**.
- 5 Locate the **Fully Developed Flow** section. In the  $U_{av}$  text field, type  $v\_mean$ .

#### *Inlet 2*

- 1 In the **Physics** toolbar, click  **Boundaries** and choose **Inlet**.
- 2 Select Boundary 15 only.
- 3 In the **Settings** window for **Inlet**, locate the **Boundary Condition** section.
- 4 From the list, choose **Fully developed flow**.
- 5 Locate the **Fully Developed Flow** section. In the  $U_{av}$  text field, type  $v\_mean$ .

#### *Outlet 1*

- 1 In the **Physics** toolbar, click  **Boundaries** and choose **Outlet**.
- 2 Select Boundaries 11 and 14 only.

#### *Symmetry 1*

- 1 In the **Physics** toolbar, click  **Boundaries** and choose **Symmetry**.
- 2 Select Boundaries 4 and 17 only.

## HEAT TRANSFER IN FLUIDS (HT)

In the **Model Builder** window, under **Component 1 (comp1)** click **Heat Transfer in Fluids (ht)**.

### *Inflow 1*

- 1 In the **Physics** toolbar, click  **Boundaries** and choose **Inflow**.
- 2 Select Boundary 5 only.
- 3 In the **Settings** window for **Inflow**, locate the **Upstream Properties** section.
- 4 In the  $T_{ustr}$  text field, type T\_hot.

### *Inflow 2*

- 1 In the **Physics** toolbar, click  **Boundaries** and choose **Inflow**.
- 2 Select Boundary 15 only.
- 3 In the **Settings** window for **Inflow**, locate the **Upstream Properties** section.
- 4 In the  $T_{ustr}$  text field, type T\_cold.

### *Outflow 1*

- 1 In the **Physics** toolbar, click  **Boundaries** and choose **Outflow**.
- 2 Select Boundaries 11 and 14 only.

## MESH 1

### *Free Triangular 1*

- 1 In the **Mesh** toolbar, click  **Boundary** and choose **Free Triangular**.
- 2 In the **Settings** window for **Free Triangular**, locate the **Boundary Selection** section.
- 3 From the **Selection** list, choose **Channel Walls**.

### *Size 1*

- 1 Right-click **Free Triangular 1** and choose **Size**.
- 2 In the **Settings** window for **Size**, locate the **Element Size** section.
- 3 Click the **Custom** button.
- 4 Locate the **Element Size Parameters** section. Select the **Maximum element size** check box.
- 5 In the associated text field, type 10[um].

### *Free Tetrahedral 1*

- 1 In the **Mesh** toolbar, click  **Free Tetrahedral**.
- 2 In the **Model Builder** window, right-click **Mesh 1** and choose **Build All**.

## STUDY 1

In the **Home** toolbar, click  **Compute**.

## RESULTS

### *Velocity (spf)*

The first default plot shows the velocity magnitude on slices.

### *Temperature (ht)*

The third default plot shows the temperature on channel inner surfaces.

To reproduce [Figure 3](#), proceed as follows:

### *Temperature Isosurfaces and Conductive Heat Flux Streamlines*

- 1 In the **Model Builder** window, under **Results** click **Isothermal Contours (ht)**.
- 2 In the **Settings** window for **3D Plot Group**, type **Temperature Isosurfaces** and **Conductive Heat Flux Streamlines** in the **Label** text field.

### *Isosurface*

- 1 In the **Model Builder** window, expand the **Temperature Isosurfaces and Conductive Heat Flux Streamlines** node, then click **Isosurface**.
- 2 In the **Settings** window for **Isosurface**, locate the **Levels** section.
- 3 From the **Entry method** list, choose **Levels**.
- 4 In the **Levels** text field, type range (301, 2, 329).

### *Temperature Isosurfaces and Conductive Heat Flux Streamlines*

In the **Model Builder** window, click

**Temperature Isosurfaces and Conductive Heat Flux Streamlines**.

### *Streamline 1*

- 1 In the **Temperature Isosurfaces and Conductive Heat Flux Streamlines** toolbar, click  **Streamline**.
- 2 In the **Settings** window for **Streamline**, click **Replace Expression** in the upper-right corner of the **Expression** section. From the menu, choose **Component 1 (comp1)>Heat Transfer in Fluids>Domain fluxes>ht.dfluxx,...,ht.dfluxz - Conductive heat flux**.
- 3 Locate the **Streamline Positioning** section. From the **Positioning** list, choose **Starting-point controlled**.
- 4 Locate the **Coloring and Style** section. Find the **Line style** subsection. From the **Type** list, choose **Tube**.
- 5 Select the **Radius scale factor** check box.

**6** Find the **Point style** subsection. From the **Type** list, choose **Arrow**.

**7** In the **Temperature Isosurfaces and Conductive Heat Flux Streamlines** toolbar, click

 **Plot.**

