



Stationary Incompressible Flow over a Backstep

Introduction

This tutorial model solves the incompressible Navier-Stokes equations in a backstep geometry. A characteristic feature of fluid flow in geometries of this kind is the recirculation region that forms where the flow exits the narrow inlet region. The model clearly demonstrates the formation of such a region, which is best displayed by visualizing the flow streamlines.

Model Definition

MODEL GEOMETRY

The model consists of a pipe connected to a block-shaped tank; see [Figure 1](#). Due to symmetry, it is sufficient to model one eighth of the full geometry. The pipe has an inlet at one end, and the tank has an outlet at the opposite end. All other boundaries are solid walls.

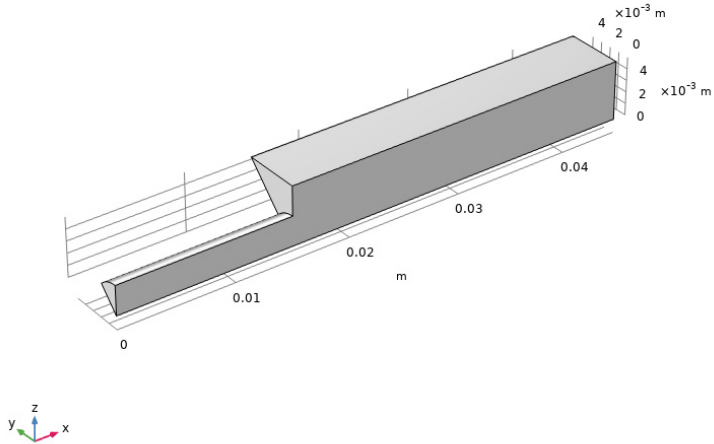

Figure 1: Model geometry.

DOMAIN EQUATION AND BOUNDARY CONDITIONS

The flow in this model is laminar, so a Laminar Flow interface will be used. The inlet flow is fully developed, which will be specified by the corresponding inlet boundary condition.

This boundary condition computes the flow profile for fully developed flow in a channel of arbitrary cross section. The boundary condition at the outlet sets a constant relative pressure. Furthermore, the vertical and inclined boundaries along the length of the geometry are symmetry boundaries. All other boundaries are solid walls described by a no slip boundary condition.

Results

Figure 2 shows a combined surface and arrow plot of the flow velocity. This plot does not reveal the recirculation region in the tank immediately beyond the inlet pipe's end. For this purpose, a streamline plot is more useful, as demonstrated in Figure 3.

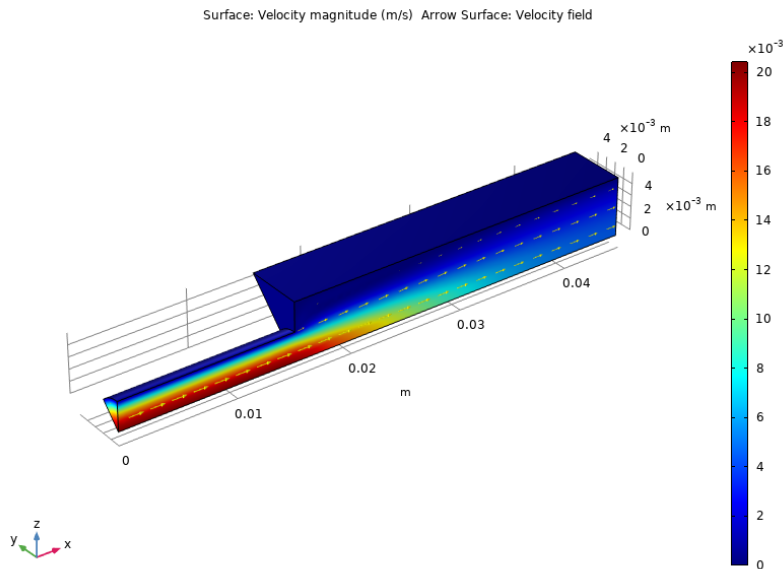

Figure 2: The velocity field in the backstep geometry.

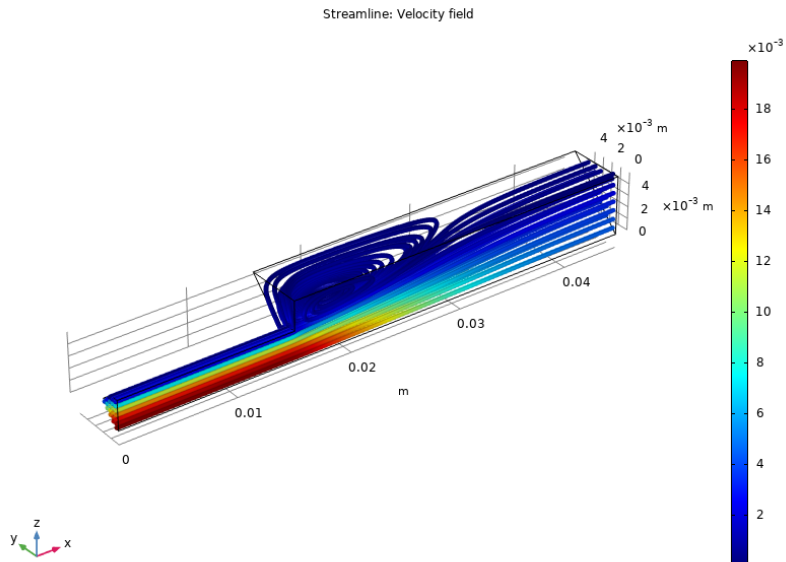



Figure 3: The recirculation region visualized using a velocity streamline plot.

Application Library path: CFD_Module/Single-Phase_Flow/backstep



Modeling Instructions

From the **File** menu, choose **New**.

NEW

In the **New** window, click  **Model Wizard**.

MODEL WIZARD

- 1** In the **Model Wizard** window, click  **3D**.
- 2** In the **Select Physics** tree, select **Fluid Flow>Single-Phase Flow>Laminar Flow (spf)**.
- 3** Click **Add**.
- 4** Click  **Study**.

- 5 In the **Select Study** tree, select **General Studies>Stationary**.
- 6 Click  **Done**.

GLOBAL DEFINITIONS



Parameters 1

- 1 In the **Model Builder** window, under **Global Definitions** click **Parameters 1**.
- 2 In the **Settings** window for **Parameters**, locate the **Parameters** section.
- 3 In the table, enter the following settings:



Name	Expression	Value	Description
v0	1 [cm/s]	0.01 m/s	Inlet velocity

GEOMETRY 1

You can build the backstep geometry from geometric primitives. Here, instead, use a file containing the sequence of geometry features that has been provided for convenience.

- 1 In the **Geometry** toolbar, click  **Insert Sequence**.
- 2 Browse to the model's Application Libraries folder and double-click the file `backstep_geom_sequence.mph`.
- 3 In the **Geometry** toolbar, click  **Build All**.
- 4 Click the  **Zoom Extents** button in the **Graphics** toolbar.
The model geometry is now complete ([Figure 1](#)).

ADD MATERIAL

- 1 In the **Home** toolbar, click  **Add Material** to open the **Add Material** window.
- 2 Go to the **Add Material** window.
- 3 In the tree, select **Built-in>Water, liquid**.
- 4 Click **Add to Component** in the window toolbar.
- 5 In the **Home** toolbar, click  **Add Material** to close the **Add Material** window.

LAMINAR FLOW (SPF)

Inlet 1

- 1 In the **Model Builder** window, under **Component 1 (comp1)** right-click **Laminar Flow (spf)** and choose **Inlet**.
- 2 Select Boundary 1 only.

- 3 In the **Settings** window for **Inlet**, locate the **Boundary Condition** section.
- 4 From the list, choose **Fully developed flow**.
- 5 Locate the **Fully Developed Flow** section. In the U_{av} text field, type $v0$.



Symmetry 1

- 1 In the **Physics** toolbar, click  **Boundaries** and choose **Symmetry**.
- 2 Select Boundaries 2 and 3 only.

Outlet 1

- 1 In the **Physics** toolbar, click  **Boundaries** and choose **Outlet**.
- 2 Select Boundary 7 only.
- 3 In the **Settings** window for **Outlet**, locate the **Pressure Conditions** section.
- 4 Select the **Normal flow** check box.

MESH 1

- 1 In the **Model Builder** window, under **Component 1 (comp1)** click **Mesh 1**.
- 2 In the **Settings** window for **Mesh**, locate the **Physics-Controlled Mesh** section.
- 3 From the **Element size** list, choose **Coarse**.
- 4 Click  **Build All**.
- 5 Click the  **Zoom Extents** button in the **Graphics** toolbar.

STUDY 1

In the **Home** toolbar, click  **Compute**.

RESULTS

A slice plot of the velocity and a plot showing the pressure distribution on the exterior walls are produced automatically. Change the slice plot to get [Figure 2](#).

Slice



- 1 In the **Model Builder** window, expand the **Velocity (spf)** node.
- 2 Right-click **Slice** and choose **Delete**. Click **Yes** to confirm.

Surface 1

In the **Model Builder** window, right-click **Velocity (spf)** and choose **Surface**.

Arrow Surface 1

- 1 Right-click **Velocity (spf)** and choose **Arrow Surface**.
- 2 In the **Settings** window for **Arrow Surface**, locate the **Coloring and Style** section.

- 3 From the **Arrow length** list, choose **Logarithmic**.
- 4 From the **Color** list, choose **Yellow**.
- 5 Click the  **Zoom Extents** button in the **Graphics** toolbar.
- 6 In the **Velocity (spf)** toolbar, click  **Plot**.

To see the recirculation effects, create a streamline plot of the velocity field.

Velocity, Streamlines

- 1 In the **Home** toolbar, click  **Add Plot Group** and choose **3D Plot Group**.
- 2 In the **Settings** window for **3D Plot Group**, type **Velocity, Streamlines** in the **Label** text field.

Streamline 1

- 1 Right-click **Velocity, Streamlines** and choose **Streamline**.
- 2 Select **Boundary 1** only.
- 3 In the **Settings** window for **Streamline**, locate the **Coloring and Style** section.
- 4 Find the **Line style** subsection. From the **Type** list, choose **Tube**.

Color Expression 1

Right-click **Streamline 1** and choose **Color Expression**.

