

# Sound Transmission Loss Through a Concrete Wall

## *Introduction*

---

This model presents a practical and efficient method to compute the sound transmission loss (STL) through a building component, specifically this example treats the case of a concrete wall. The method, used here, is valid as long as the component has little influence on the acoustic field on the source side. The method is based on assuming an ideal diffuse field on the source side and an ideal anechoic termination on the receiver side of the concrete wall. In typical measurement setups, the diffuse sound field is generated in a reverberation room. At low frequencies, the fields that you can obtain are less than perfectly diffuse. The measured STL will therefore to some extent depend on the experimental conditions. From the approach used in this model, you can extract an ideal, experiment-independent STL. The obtained results are compared to published experimental data and shows good agreement.

## *Model Definition*

---

In this tutorial, the sound transmission loss (STL) through a concrete wall will be modeled using an approach that is well suited for numerical simulations. A review of STL measurement techniques and theory is given below in order to motivate the simulation approach used here. Following this discussion, the method is described in detail.

### **SOUND TRANSMISSION LOSS (STL)**

The STL through a building component, like a door, a window, a wall segment, or a sound insulation structure, is defined as the ratio of the total incident power  $P_{\text{in}}$ , on the structure, relative to the total transmitted power  $P_{\text{tr}}$  (measured on the dB scale),

$$\text{STL} = 10 \log_{10} \left( \frac{P_{\text{in}}}{P_{\text{tr}}} \right) \quad (1)$$

The STL is defined for conditions where the acoustic field on the source side is a diffuse acoustic field. Several standards exist for the measurement of the STL, for example, ASTM E90 or ISO 10140. Common to the methods is that they are devised in order to directly or indirectly measure the incident and transmitted power using various methods. Typically, a so-called two-room method is used. The two most common configurations both use a reverberation room on the source side. The first also uses a reverberation room on the receiver side (reverberant-reverberant) while the second uses an anechoic room on the receiver side (reverberant-anechoic). The two configurations are sketched in [Figure 1](#).

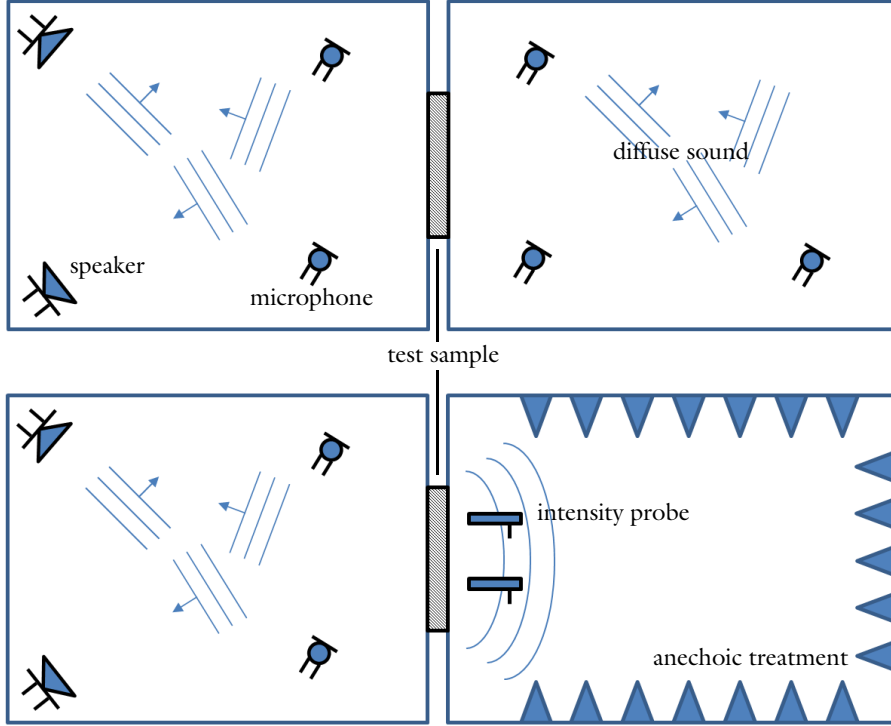

Figure 1: The two variations of the two-room configuration for measuring the sound transmission loss: (top) both source and receiver reverberation rooms, and (bottom) the source reverberation room and receiver anechoic room.

In both cases, the incident power on the source side is computed as

$$P_{\text{in}} = \frac{p_{\text{rms}}^2}{4\rho c} S_s \quad (2)$$

where  $S_s$  is the area of the test surface on the source side (the area of the concrete wall tested),  $p_{\text{rms}}$  is the RMS pressure in the source room,  $\rho$  is the density, and  $c$  is the speed of sound. This expression is derived by considering the incident power on a surface in an ideal diffuse acoustic field, see [Ref. 1](#) and [Ref. 2](#).

The expressions used to compute the incident and transmitted power for the reverberant-reverberant case are only valid as long as the acoustic field is diffuse. A measure for the transition from modal to diffuse behavior is given by the Schroeder frequency

$$f_s = 2000 \text{ Hz} \sqrt{\frac{T_{60}}{V}} \quad (3)$$

where  $V$  is the room volume and  $T_{60}$  is the reverberation time; see [Ref. 1](#). A room of volume  $V$  is said to be acoustically large when the studied frequency  $f$  is larger than the Schroeder frequency, giving the condition

$$V > \left( \frac{2000 \text{ Hz}}{f} \right)^2 T_{60} \quad (4)$$

#### *Reverberant-Reverberant Setup*

In the setup where also the receiver room is a reverberation room ([Figure 1](#) top) and the sound field is assumed diffuse, the transmitted power is given by

$$P_{\text{tr}} = \frac{p_{\text{rms}}^2}{4\rho c} A_r \quad A_r = \sum_i S_i \alpha_i \quad (5)$$

where  $p_{\text{rms}}$  is the RMS pressure in the receiver room and  $A_r$  is the receiver room absorption, that is, the product of each area  $S_i$  and its absorption coefficient  $\alpha_i$ . The expression stems from an energy balance consideration, that is, the total absorbed energy is equal to the radiated energy of a source. Combining [Equation 2](#) and [Equation 5](#) gives the expression for the STL for the reverberant-reverberant setup

$$\text{STL} = \text{SPL}_s - \text{SPL}_r + 10 \log_{10} \left( \frac{S_s}{A_r} \right) \quad (6)$$

where  $\text{SPL}_s$  and  $\text{SPL}_r$  is the average sound pressure level in the source and the receiver room, respectively. Averaging is of course done on the RMS pressure before transforming to the dB scale.

Note that a correction to [Equation 5](#) is sometimes introduced (it is based on the Waterhouse expression). At walls (in a room with a diffuse field), the RMS pressure will be larger by a factor 2, because the incident and reflected fields are correlated, see [Ref. 2](#). The expression reads

$$P_{\text{tr}} = \frac{p_{\text{rms}}^2}{\rho c^2} V_r \left( 1 + \frac{S_{r,\text{room}} \lambda}{8V_r} \right) \frac{13.8}{T_e} \quad (7)$$

where  $T_e$  is the early decay time,  $V_r$  is the receiver room volume,  $S_{r,\text{room}}$  the receiver room surface area, and  $\lambda$  is the wavelength.

### Reverberant-Anechoic Setup

In the reverberant-anechoic configuration (Figure 1 bottom), the transmitted power is directly measured on the receiver side using an intensity probe. The measurement is performed in several locations in front of the test element and averaged. The transmitted power is then simply given by

$$P_{\text{tr}} = S_{\text{r}} I_{\text{tr}} \quad (8)$$

combining this expression with Equation 1 and Equation 2 gives

$$\text{STL} = \text{SPL}_{\text{s}} - \text{SIL}_{\text{tr}} + 10 \log_{10} \left( \frac{S_{\text{s}}}{S_{\text{r}}} \right) - 6.14 \quad (9)$$

for flat samples  $S_{\text{s}} = S_{\text{r}}$  and  $\text{SIL}_{\text{tr}}$  is the transmitted (measured) sound intensity level. The numeric constant stems directly from the definitions of SPL and SIL and the equations for the power, it is expressed as

$$10 \log_{10} \left( \frac{1 p_{\text{ref}}^2}{4 I_{\text{ref}} \rho c} \right) \approx -6.14 \quad (10)$$

where  $p_{\text{ref}} = 20 \mu\text{Pa}$ ,  $I_{\text{ref}} = 10^{-12} \text{ W/m}^2$ ,  $\rho = 1.2 \text{ kg/m}^3$ , and  $c = 343 \text{ m/s}$ .

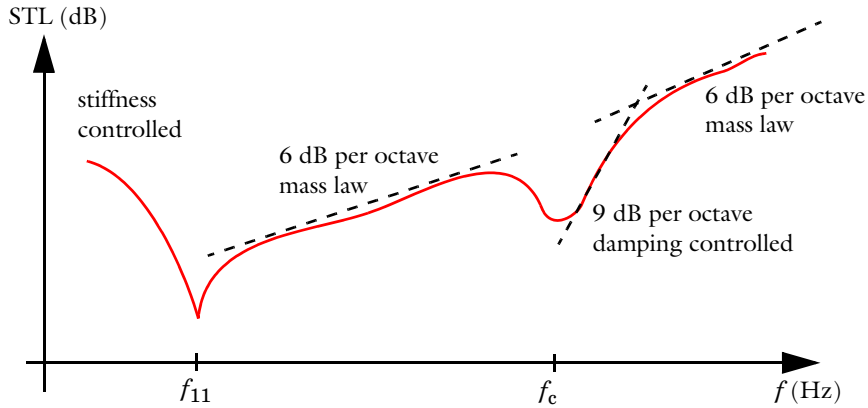

Figure 2: Schematic representation of the frequency dependency of the STL for panels made of isotropic materials.

### ESTIMATION MODEL FOR THE STL

The STL for panels (like the wall studied here) has a general frequency dependent behavior that is sketched in Figure 2 for the case of isotropic elastic materials (see Ref. 3). At low

frequencies, below the first mechanical (panel) resonance  $f_{11}$  of the structure, the STL is stiffness controlled. At and around the resonance the STL drops drastically as the structure acts as an optimal transmitter (dips can also occur for the second mode). Above the first resonance the STL becomes mass controlled. This is in a relatively large frequency band where the STL increases with 6 dB per octave. Then at the critical frequency  $f_c$ , in a region called the coincidence region, the STL decreases. Coincidence happens when the wavelength of the pressure waves in the fluid are comparable to wavelength of the flexural waves in the structure. Above this region the STL increases. It is first damping controlled (9 dB per octave) before it approaches the mass law behavior again.

Several analytical prediction models exist for the STL for a simply supported panels (plates or walls), see [Ref. 3](#). In the mass law region one model, called Sharp's equation (for 1/3 octave STL values), is given as

$$STL = 10 \log_{10} \left( 1 + \left( \frac{\pi f m}{\rho c} \right)^2 \right) - 5.5 \text{ dB} \quad (11)$$

where  $m = \rho_{\text{solid}} \cdot T$  is the mass per unit area of the structure,  $\rho_{\text{solid}}$  is the density of the structure, and  $T$  is the thickness of the panel (here the wall, see [Figure 3](#)). Note that the predicted STL from Sharp's equation will in practice exceed the actual STL. This is because the equation assumes an ideal limp panel and does not take into account the panel stiffness. This same trend is seen in the model results discussed below. The slope in the mass law region will obey the 6 dB per octave trend. A doubling of the wall thickness will double the value of  $m$  and thus results in a 6 dB increase in STL for a given frequency.

### IDEAL MODEL SETUP

When simulating the STL we want to avoid having to model the source and receiver rooms as this would be computationally extremely expensive. Instead the setup is based on assuming an ideal diffuse field on the source side and an ideal anechoic termination on the receiver side of the test sample (here a concrete wall). Experimentally measured STL values will to some extent depend on the experimental conditions. The model also assumes that the test sample has little influence on the sound field on the source side. This is true for relatively stiff structures with low acoustic absorption properties. This is the case for the concrete wall studied in this example. In this case the sound field on the source side (the source room) can be defined as a sum of  $N$  uncorrelated plane waves moving in random directions. The source room pressure field is then

$$\begin{aligned}
p_{\text{room}} &= \frac{1}{\sqrt{N}} \sum_{n=1}^N \exp(-i(k_{n,x}x + k_{n,y}y + k_{n,z}z)) \exp(i\Phi_n) \\
k_{n,x} &= \cos(\theta_n) \\
k_{n,y} &= \sin(\theta_n) \cos(\varphi_n) \\
k_{n,z} &= \sin(\theta_n) \sin(\varphi_n)
\end{aligned} \tag{12}$$

where the polar angles  $\theta_n$  and  $\varphi_n$ , and the phase  $\Phi_n$  are independent random numbers. In the model, a new set of random numbers is generated for each  $n$  in the sum. The  $1/\sqrt{N}$  term ensures that the field has a constant intensity for any choice of  $N$ . The theoretical limit, for large  $N$ , of the average RMS pressure in the room (measured away from walls) will then be  $p_{\text{rms}} = 1/\sqrt{2}$  Pa .

At the concrete wall (placed in the  $x = 0$  plane), the diffuse field is reflected. The reflected component of the field is

$$p_{\text{refl}} = \frac{1}{\sqrt{N}} \sum_{n=1}^N \exp(-i(-k_{n,x}x + k_{n,y}y + k_{n,z}z)) \exp(i\Phi_n). \tag{13}$$

The reflected field is coherent with the incident field (as discussed for [Equation 5](#)). At the surface of the concrete well, the total pressure load applied to the structure is the sum of the diffuse room pressure and the reflected pressure

$$p_{\text{wall}} = p_{\text{room}} + p_{\text{refl}} \tag{14}$$

In the model, the room pressure, the reflected pressure, and wall pressures are defined as global variables.

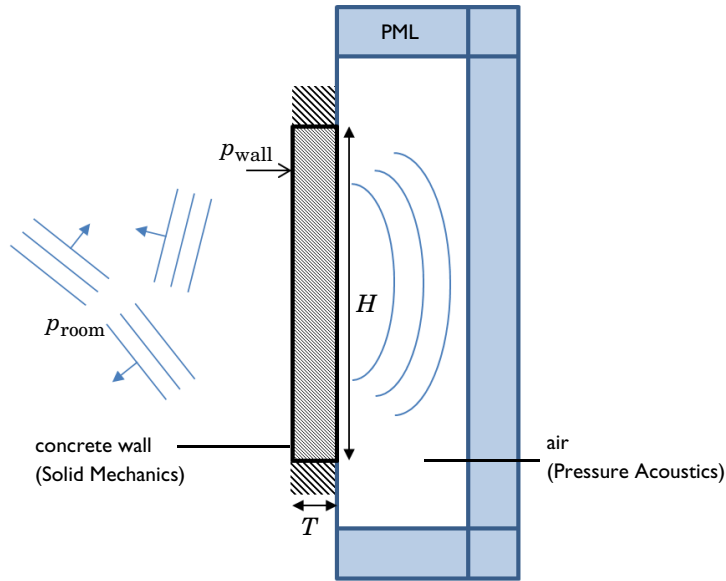

*Figure 3: Model setup of a concrete wall with an ideal diffuse field on the source side and an ideal anechoic termination on the receiver side.*

The wall pressure  $p_{\text{wall}}$  is applied as a load on the source side of the concrete wall. On the receiver side, a perfect anechoic room is modeled using an air domain terminated by a perfectly matched layer (PML). The model setup is sketched in [Figure 3](#).

The concrete wall has a height of  $H = 4.37$  m, a width of  $W = 2.84$  m, and a thickness of  $T = 203$  mm. The density of the concrete is  $\rho_{\text{con}} = 2275$  kg/m<sup>3</sup>, the Young's modulus is  $E_{\text{con}} = 31.6$  GPa, the Poisson ratio is 0.2, and a typical value of 0.01 is used as the isotropic loss factor. The wall size and material data is taken from the test configuration called 76-77 described in [Ref. 4](#). The wall is assumed fixed at its outer boundary and placed in an ideal surrounding wall that does not contribute to the STL.

Note that the fixed constraint used here is different from the “simply supported” condition (a hinge-like condition) often used in the analytical prediction models. To precisely predict measurements or model the behavior of building components in-situ a good description of the outer boundary conditions is of course required. The condition used will, for example, have a significant influence on the low frequency stiffness controlled behavior of the STL.



## Results and Discussion

The incident intensity distribution on the concrete wall is depicted in Figure 4, evaluated at 100 Hz, 250 Hz, 500 Hz, and 1000 Hz. The distribution is not dependent on the solved model but only on the randomness and number of terms in the expression for the room pressure room pressure field  $p_{\text{room}}$  from Equation 12.

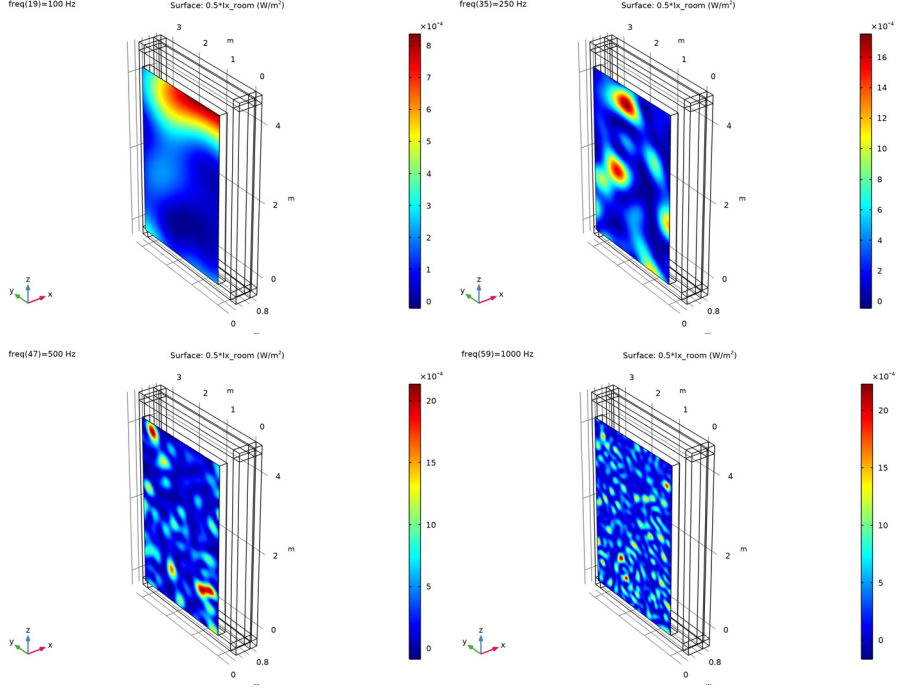

Figure 4: The incident intensity evaluated in the concrete wall surface.

The incident intensity on the half space (in the  $x$ -direction) is computed using its definition as

$$I_{x, \text{in}} = \frac{11}{22} \text{Re}(p_{\text{room}} v_{x, \text{room}}^*) \quad (15)$$

$$v_{x, \text{room}} = \frac{-1}{i\omega\rho} \frac{\partial p_{\text{room}}}{\partial x}$$

where the extra factor  $1/2$  is necessary as it is only the incident component of the room field that should be used (half space contribution). The spatial distribution of the

transmitted (radiated) intensity is depicted for the same frequencies in Figure 5. The transmitted intensity depends on the solved problem and is computed as

$$I_{x, \text{tr}} = \frac{1}{2} \text{Re}(p_t(i\omega u)^*) \quad (16)$$

where  $p_t$  is the total acoustic pressure and  $u$  is the structural displacement in the  $x$  direction. Both variables are solved for in the model.

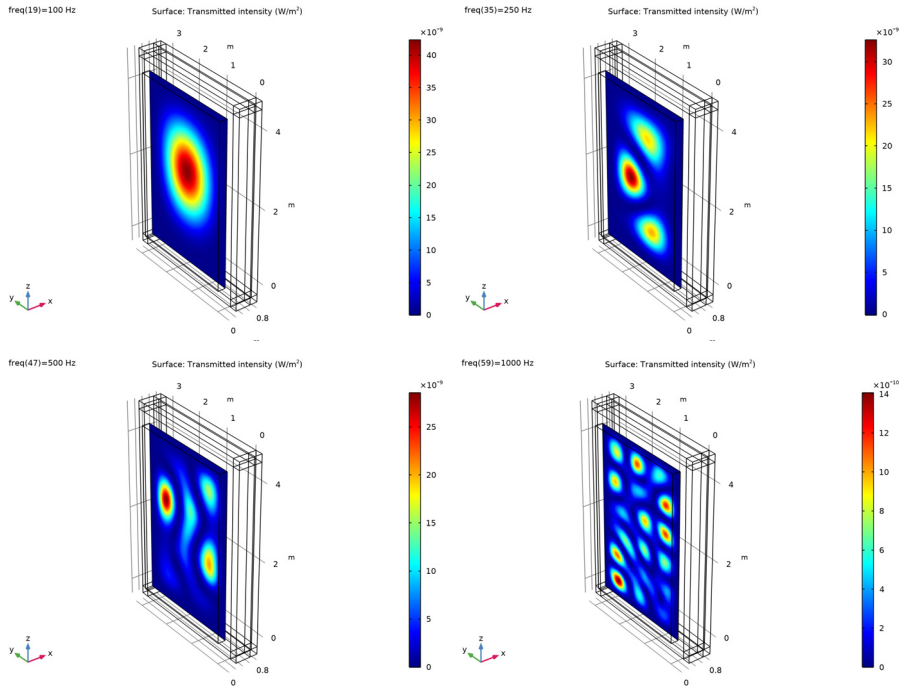
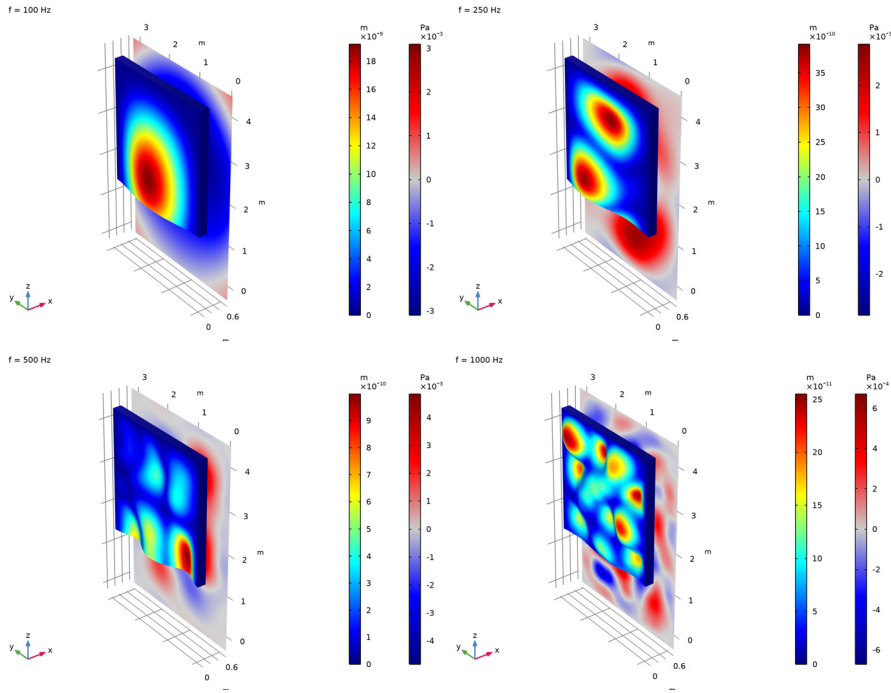

Figure 5: The transmitted intensity evaluated on the concrete wall surface.

The displacement of the concrete wall, as well as the pressure in the receiver room, is depicted in Figure 6 for the same four frequencies. At the low frequencies, the displacement distribution is strongly dictated by the possible modes of the structure.

Comparing this to [Figure 5](#) it is also evident that the transmitted intensity field is controlled by the displacement.



*Figure 6: The displacement of the concrete wall and the pressure on the receiver side.*

The sound transmission loss (STL), computed using [Equation 1](#), [Equation 2](#), and [Equation 8](#), is depicted in [Figure 7](#) and [Figure 8](#). The STL is depicted as a continuous line (evaluated for all the computed frequencies) as well as in octave bands or 1/3 octave bands, respectively. Both graphs also include the typically measured STL. The data is adapted from [Ref. 4](#) and shows good agreement.

In [Figure 7](#) the estimated STL using Sharp's equation (see [Equation 11](#)) is also depicted in the region where the mass law applies. The estimate shows the same trend with the correct slope (6 dB per octave) but overestimates the STL. This is expected as Sharp's equation assumes a limp structure and does not include the stiffness effects.

The dips in the STL curve correspond to the first two structural modes which are depicted in [Figure 10](#). They occur at  $f_{11} = 113$  Hz and  $f_{12} = 170$  Hz. Below these frequencies the STL is stiffness controlled and depends highly on the boundary conditions applied to the structure. The mass law behavior applies above these.

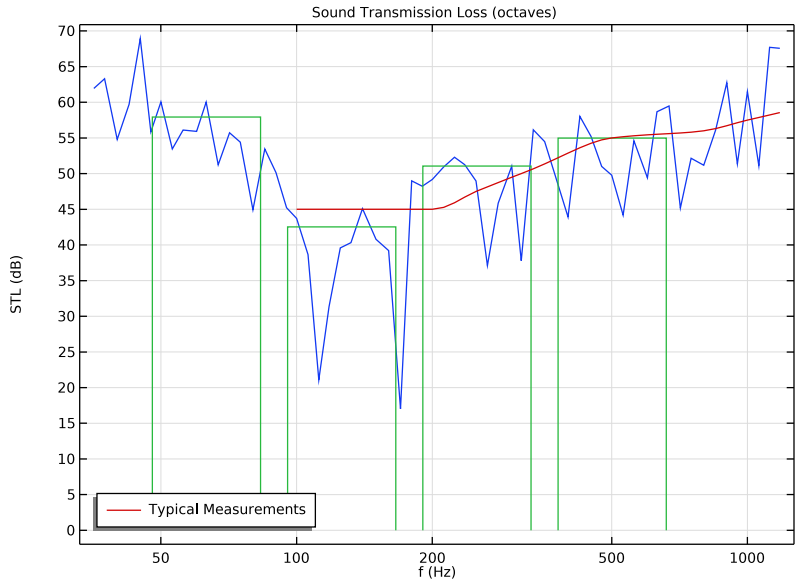

Figure 7: Sound transmission loss (STL) through the concrete wall with octave bands.

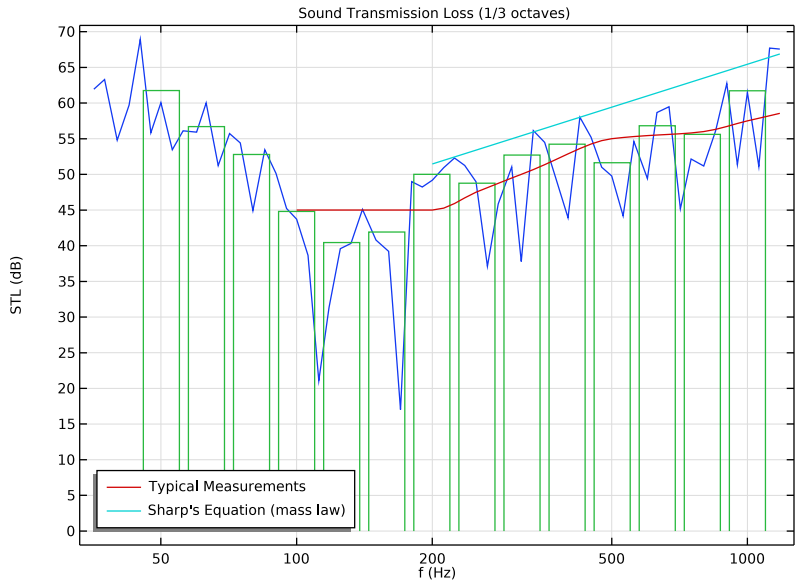
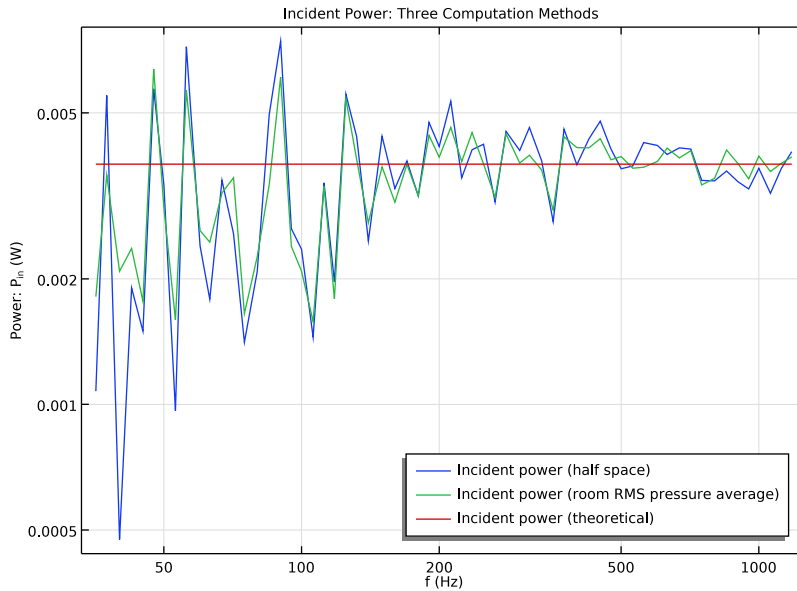
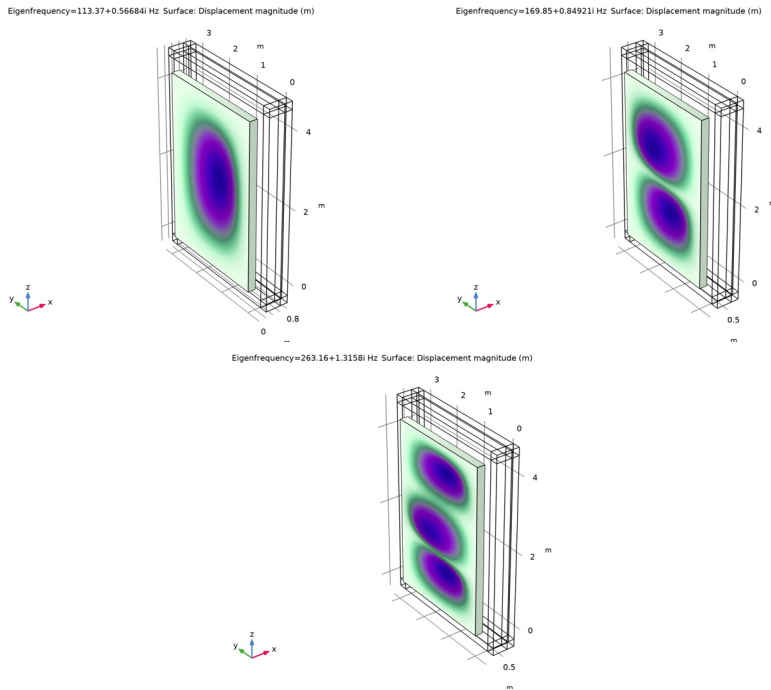

Figure 8: Sound transmission loss (STL) through the concrete wall with 1/3 octave bands.

Finally, **Figure 9** depicts the incident power on the wall computed using three different methods. The blue graph shows the value given by the surface integral of **Equation 15**. The green graph represents the value given by **Equation 2** where the RMS pressure is given as the average of  $p_{\text{room}}$  over the wall surface. The red graph is also computed using **Equation 2** but with the RMS pressure set to the theoretical value  $p_{\text{rms}} = 1/\sqrt{2}$  Pa . The graphs indicate the expected large fluctuations at low frequencies where the wavelength is comparable to the wall size. In measurement conditions the field would also not be diffuse at these low frequencies.



*Figure 9: The incident power on the wall evaluated using three different methods.*



*Figure 10: The first three modes of the structure.*

### *Notes About the COMSOL Implementation*

---

The model is based on several assumptions:

- Perfect diffuse field in the source room.
- Perfect anechoic behavior in the receiver room.
- The structure under analysis has a negligible influence on the source room acoustic field. This means that structure is stiff and has low absorption.

If the test sample does not meet the last requirement, then the source field acoustics needs to be solved coupled with the structure. This can of course also be done.

### *References*

---

1. H. Kuttruff, *Room Acoustics*, CRC Press, Fifth Edition, 2009.

2. F. Jacobsen, “The Sound Field in a Reverberation Room,” Lecture Note no. 31261, Acoustic, Technology, Technical University of Denmark, 2011.
3. D. A. Bies C. Hansen, and C. Howard, “Engineering Noise Control,” 5th Edition, CRC Press, 2017.
4. A. Litvin and H.W. Belliston, “Sound Transmission Loss Through Concrete and Concrete Masonry Walls,” *American Concrete Institute, Journal Proceedings*, vol. 45, pp. 641–646, 1978.

---

**Application Library path:** Acoustics\_Module/Building\_and\_Room\_Acoustics/sound\_transmission\_loss\_concrete

---

### *Modeling Instructions*



---

From the **File** menu, choose **New**.

#### **NEW**

In the **New** window, click  **Model Wizard**.

#### **MODEL WIZARD**

- 1 In the **Model Wizard** window, click  **3D**.
- 2 In the **Select Physics** tree, select **Acoustics>Acoustic-Structure Interaction>Acoustic-Solid Interaction, Frequency Domain**.
- 3 Click **Add**.
- 4 Click  **Study**.
- 5 In the **Select Study** tree, select **General Studies>Frequency Domain**.
- 6 Click  **Done**.

#### **GLOBAL DEFINITIONS**

##### *Parameters 1*

- 1 In the **Model Builder** window, under **Global Definitions** click **Parameters 1**.
- 2 In the **Settings** window for **Parameters**, locate the **Parameters** section.
- 3 Click  **Load from File**.

- 4 Browse to the model's Application Libraries folder and double-click the file `sound_transmission_loss_concrete_parameters.txt`.  
Create an interpolation function that contains typical measurement data of the STL for the concrete wall.

*Interpolation 1 (int1)*

- 1 In the **Home** toolbar, click  **Functions** and choose **Global>Interpolation**.
- 2 In the **Settings** window for **Interpolation**, locate the **Definition** section.
- 3 From the **Data source** list, choose **File**.
- 4 Click **Browse**.
- 5 Browse to the model's Application Libraries folder and double-click the file `sound_transmission_loss_concrete_measurement_data.txt`.
- 6 Find the **Functions** subsection. In the table, enter the following settings:

Function name	Position in file
STL_typical	1

- 7 Click **Import**.
- 8 Locate the **Interpolation and Extrapolation** section. From the **Interpolation** list, choose **Piecewise cubic**.
- 9 Locate the **Units** section. In the **Arguments** text field, type Hz.
- 10 In the **Function** text field, type dB.

**GEOMETRY 1**

*Block 1 (blk1)*

- 1 In the **Geometry** toolbar, click  **Block**.
- 2 In the **Settings** window for **Block**, locate the **Size and Shape** section.
- 3 In the **Width** text field, type T.
- 4 In the **Depth** text field, type W.
- 5 In the **Height** text field, type H.

*Block 2 (blk2)*

- 1 In the **Geometry** toolbar, click  **Block**.
- 2 In the **Settings** window for **Block**, locate the **Size and Shape** section.
- 3 In the **Width** text field, type 3\*T.
- 4 In the **Depth** text field, type W+4\*T.





## SOLID MECHANICS (SOLID)

- 1 In the **Model Builder** window, under **Component 1 (comp1)** click **Solid Mechanics (solid)**.
- 2 In the **Settings** window for **Solid Mechanics**, locate the **Domain Selection** section.
- 3 Click  **Clear Selection**.
- 4 Select Domain 1 only.



## MULTIPHYSICS

*Acoustic-Structure Boundary 1 (asb1)*

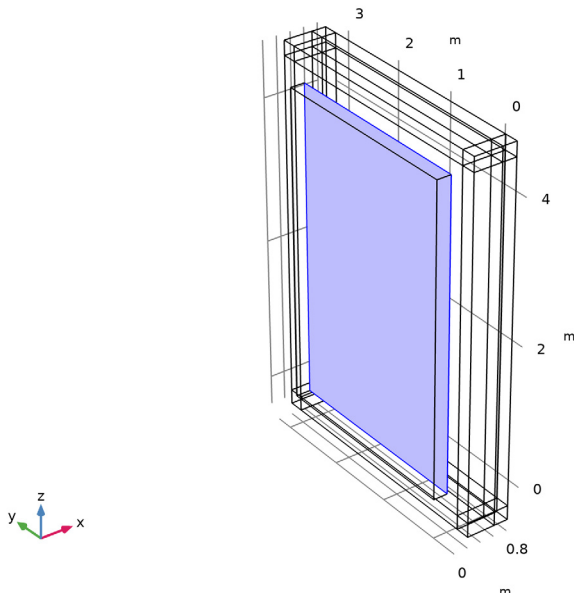
Click the  **Wireframe Rendering** button in the **Graphics** toolbar.



## ADD MATERIAL

- 1 In the **Home** toolbar, click  **Add Material** to open the **Add Material** window.
- 2 Go to the **Add Material** window.
- 3 In the tree, select **Built-in>Air**.
- 4 Click **Add to Component** in the window toolbar.
- 5 In the **Home** toolbar, click  **Add Material** to close the **Add Material** window.

## MATERIALS

### Concrete

- 1 In the **Model Builder** window, under **Component 1 (comp1)** right-click **Materials** and choose **Blank Material**.
- 2 In the **Settings** window for **Material**, type Concrete in the **Label** text field.
- 3 Select Domain 1 only.
- 4 Locate the **Material Contents** section. In the table, enter the following settings:

Property	Variable	Value	Unit	Property group
Young's modulus	E	31.6e9	Pa	Basic
Poisson's ratio	nu	0.2	l	Basic
Density	rho	2275	kg/m <sup>3</sup>	Basic

## DEFINITIONS

### Variables: Diffuse Field

- 1 In the **Model Builder** window, under **Component 1 (comp1)** right-click **Definitions** and choose **Variables**.
- 2 In the **Settings** window for **Variables**, type Variables: Diffuse Field in the **Label** text field.
- 3 Locate the **Variables** section. Click  **Load from File**.
- 4 Browse to the model's Application Libraries folder and double-click the file sound\_transmission\_loss\_concrete\_variables\_diffuse.txt.

### Variables: STL

- 1 In the **Model Builder** window, right-click **Definitions** and choose **Variables**.
- 2 In the **Settings** window for **Variables**, type Variables: STL in the **Label** text field.
- 3 Locate the **Variables** section. Click  **Load from File**.
- 4 Browse to the model's Application Libraries folder and double-click the file sound\_transmission\_loss\_concrete\_variables\_stl.txt.

### Random I (rnl)

- 1 In the **Home** toolbar, click  **Functions** and choose **Local>Random**.
- 2 In the **Settings** window for **Random**, type costheta\_rnd in the **Function name** text field.
- 3 Locate the **Parameters** section. In the **Number of arguments** text field, type 4.
- 4 In the **Mean** text field, type 0.5.

#### *Random 2 (rn2)*

- 1 In the **Home** toolbar, click  **Functions** and choose **Local>Random**.
- 2 In the **Settings** window for **Random**, type phi\_rnd in the **Function name** text field.
- 3 Locate the **Parameters** section. In the **Number of arguments** text field, type 4.
- 4 In the **Mean** text field, type pi.
- 5 In the **Range** text field, type 2\*pi.

#### *Random 3 (rn3)*

- 1 In the **Home** toolbar, click  **Functions** and choose **Local>Random**.
- 2 In the **Settings** window for **Random**, type phase\_rnd in the **Function name** text field.
- 3 Locate the **Parameters** section. In the **Number of arguments** text field, type 4.
- 4 In the **Mean** text field, type pi.
- 5 In the **Range** text field, type 2\*pi.

#### *Integration 1 (intop1)*

- 1 In the **Definitions** toolbar, click  **Nonlocal Couplings** and choose **Integration**.
- 2 In the **Settings** window for **Integration**, type intop\_in in the **Operator name** text field.
- 3 Locate the **Source Selection** section. From the **Geometric entity level** list, choose **Boundary**.
- 4 Select Boundary 1 only.

#### *Integration 2 (intop2)*

- 1 In the **Definitions** toolbar, click  **Nonlocal Couplings** and choose **Integration**.
- 2 In the **Settings** window for **Integration**, type intop\_tr in the **Operator name** text field.
- 3 Locate the **Source Selection** section. From the **Geometric entity level** list, choose **Boundary**.
- 4 Select Boundary 26 only.

#### *Save solution on boundaries*

- 1 In the **Definitions** toolbar, click  **Explicit**.
- 2 In the **Settings** window for **Explicit**, type Save solution on boundaries in the **Label** text field.
- 3 Locate the **Input Entities** section. From the **Geometric entity level** list, choose **Boundary**.

4 Select Boundaries 1-5, 19, 26, and 53 only.

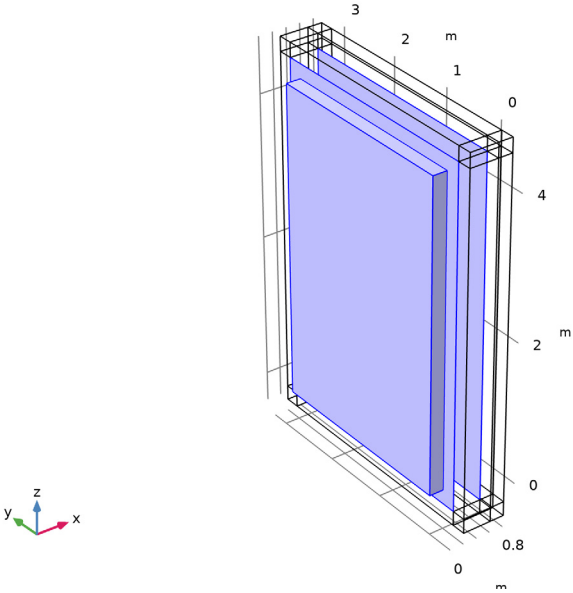

*Perfectly Matched Layer 1 (pml1)*

I In the **Definitions** toolbar, click  **Perfectly Matched Layer**.

2 Select Domains 2–5 and 7–19 only.

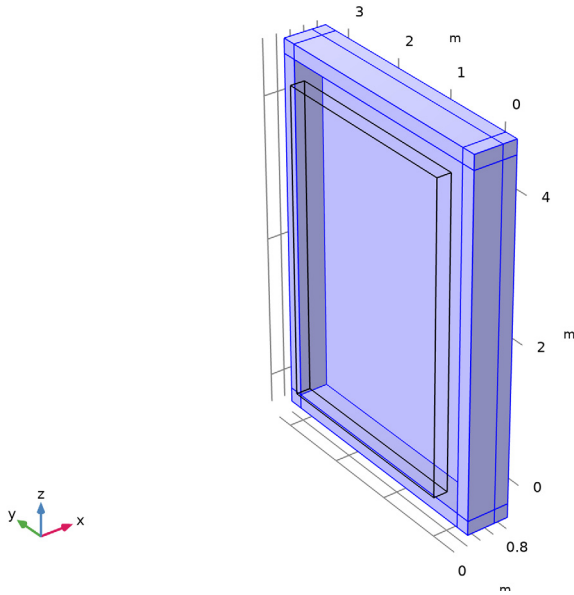

3 In the **Settings** window for **Perfectly Matched Layer**, locate the **Scaling** section.

4 In the **PML scaling curvature parameter** text field, type 2.

## SOLID MECHANICS (SOLID)

### *Linear Elastic Material I*

In the **Model Builder** window, under **Component I (comp1)>Solid Mechanics (solid)** click **Linear Elastic Material I**.

### *Damping I*

1 In the **Physics** toolbar, click  **Attributes** and choose **Damping**.

2 In the **Settings** window for **Damping**, locate the **Damping Settings** section.

3 From the **Damping type** list, choose **Isotropic loss factor**.

Remember to go back to the Concrete material and add the value for the isotropic loss factor.

## MATERIALS

*Concrete (mat2)*

- 1 In the **Model Builder** window, under **Component 1 (comp1)>Materials** click **Concrete (mat2)**.
- 2 In the **Settings** window for **Material**, locate the **Material Contents** section.
- 3 In the table, enter the following settings:

Property	Variable	Value	Unit	Property group
Isotropic structural loss factor	eta_s	0.01		Basic

## SOLID MECHANICS (SOLID)

*Fixed Constraint 1*

- 1 In the **Physics** toolbar, click  **Boundaries** and choose **Fixed Constraint**.
- 2 Select Boundaries 2–5 only.

The selection should look like this.

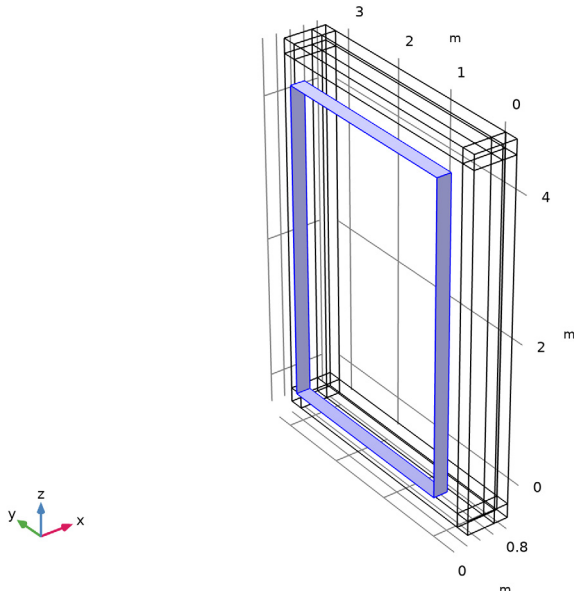

*Boundary Load 1*

- 1 In the **Physics** toolbar, click  **Boundaries** and choose **Boundary Load**.

- 2 Select Boundary 1 only.
- 3 In the **Settings** window for **Boundary Load**, locate the **Force** section.
- 4 From the **Load type** list, choose **Pressure**.
- 5 In the  $p$  text field, type  $p_{wall}$ .

The following steps show how to create a swept mesh to reduce the computation time.

## MESH 1

### *Free Quad 1*

- 1 In the **Mesh** toolbar, click  **Boundary** and choose **Free Quad**.
- 2 Select Boundary 19 only.

### *Size*

- 1 In the **Model Builder** window, click **Size**.
- 2 In the **Settings** window for **Size**, locate the **Element Size** section.
- 3 Click the **Custom** button.
- 4 Locate the **Element Size Parameters** section. In the **Maximum element size** text field, type  $c0/f_{max}/5$ .
- 5 In the **Minimum element size** text field, type  $c0/f_{max}/6$ .

### *Mapped 1*

- 1 In the **Mesh** toolbar, click  **Boundary** and choose **Mapped**.
- 2 Select Boundaries 6, 9, 12, 16, 22, 26, 27, 30, and 33 only.

### *Distribution 1*

- 1 Right-click **Mapped 1** and choose **Distribution**.
- 2 Select Edges 16, 26, 35, and 39 only.
- 3 In the **Settings** window for **Distribution**, locate the **Distribution** section.
- 4 In the **Number of elements** text field, type 8.
- 5 Click  **Build All**.

### *Swept 1*

In the **Mesh** toolbar, click  **Swept**.



### *Distribution 1*

- 1 Right-click **Swept 1** and choose **Distribution**.
- 2 In the **Settings** window for **Distribution**, locate the **Domain Selection** section.



- 3 Click  **Clear Selection**.
- 4 Select Domain 1 only.
- 5 Locate the **Distribution** section. In the **Number of elements** text field, type 2.

*Distribution 2*

- 1 In the **Model Builder** window, right-click **Swept 1** and choose **Distribution**.
- 2 In the **Settings** window for **Distribution**, locate the **Domain Selection** section.
- 3 Click  **Clear Selection**.
- 4 Click the  **Entity Intersects** button in the **Graphics** toolbar.
- 5 Select Domains 11–19 only.
- 6 Locate the **Distribution** section. In the **Number of elements** text field, type 8.
- 7 Click  **Build All**.

The mesh should look like this.

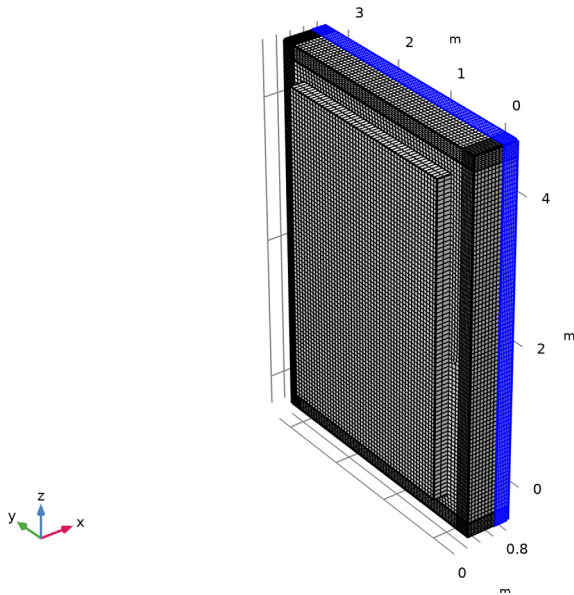

## STUDY 1

### *Solution 1 (sol1)*

1 In the **Study** toolbar, click  **Show Default Solver**.

The default solver works, but to reduce the computation time, enable the second suggested iterative solver. This solver is both faster and more memory efficient than the default direct solver. It uses a multigrid preconditioner for the acoustic variables and a direct preconditioner for the solid mechanics variables.

2 In the **Model Builder** window, expand the **Solution 1 (sol1)** node.

3 In the **Model Builder** window, expand the **Study 1>Solver Configurations>Solution 1 (sol1)>Stationary Solver 1** node.

4 Right-click **Study 1>Solver Configurations>Solution 1 (sol1)>Stationary Solver 1>Suggested Iterative Solver (GMRES with GMG and Direct Precond.) (asbl)** and choose **Enable**.

### *Step 1: Frequency Domain*

1 In the **Model Builder** window, click **Step 1: Frequency Domain**.

2 In the **Settings** window for **Frequency Domain**, locate the **Study Settings** section.

3 Click  **Range**.

4 In the **Range** dialog box, choose **ISO preferred frequencies** from the **Entry method** list.

5 In the **Start frequency** text field, type 35.

6 In the **Stop frequency** text field, type fmax.

7 From the **Interval** list, choose **1/12 octave**.

8 Click **Replace**.

9 In the **Settings** window for **Frequency Domain**, click to expand the **Values of Dependent Variables** section.

10 Find the **Store fields in output** subsection. From the **Settings** list, choose **For selections**.

11 Under **Selections**, click  **Add**.

To reduce the model size when saved, only store the solution on the selected boundaries.

12 In the **Add** dialog box, select **Save solution on boundaries** in the **Selections** list.

13 Click **OK**.

14 In the **Study** toolbar, click  **Compute**.

## RESULTS

### *Acoustic Pressure (acpr)*

Inspect the default plots generated, you can change the evaluation frequency if needed. Notice that the isosurface plot is less interesting as we have only stored the solution on boundaries.

freq(62)=1180 Hz

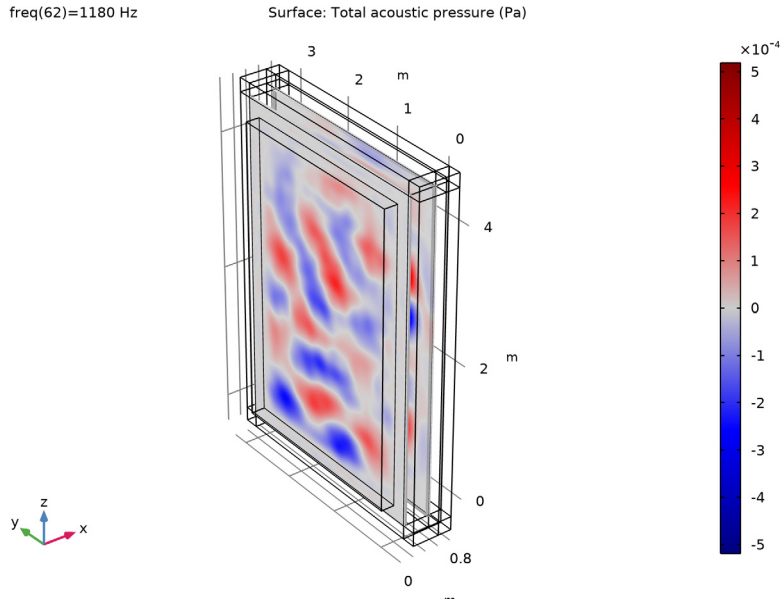

### Sound Pressure Level (acpr)

freq(62)=1180 Hz

Surface: Total sound pressure level (dB)

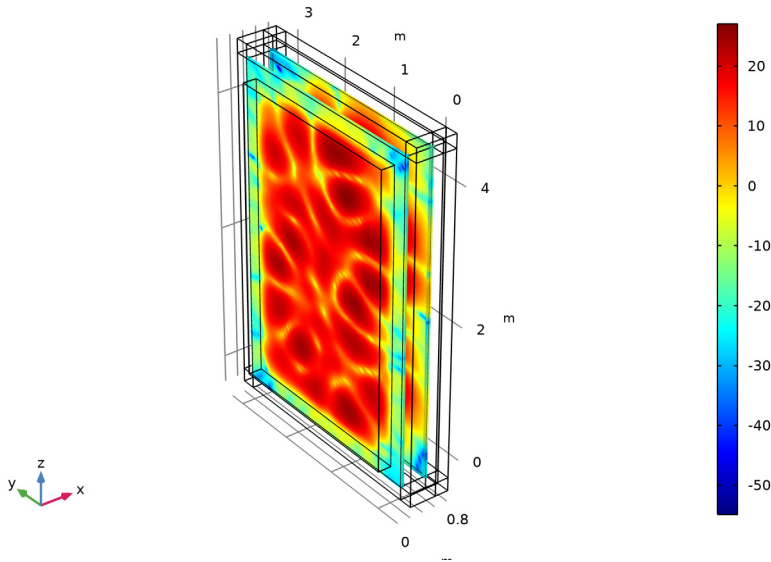

### Acoustic Pressure, Isosurfaces (acpr)

freq(62)=1180 Hz

Isosurface: Total acoustic pressure (Pa)

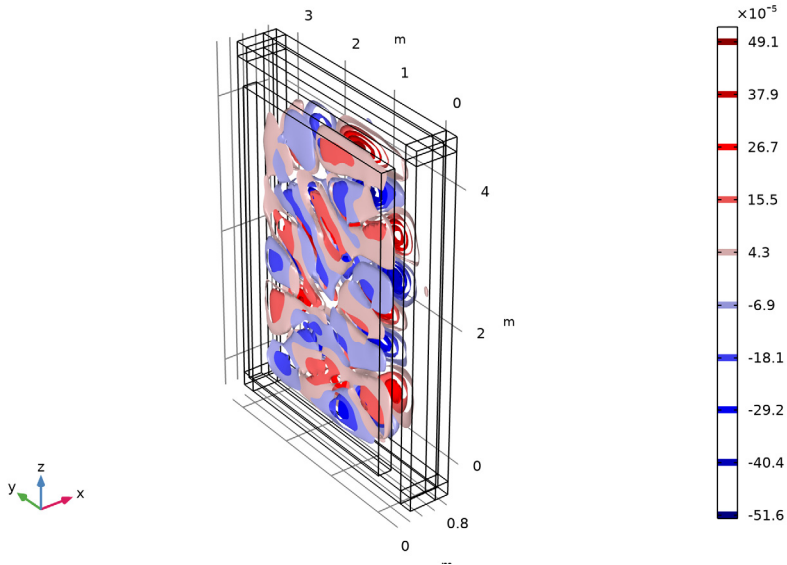

## Stress (solid)

freq(62)=1180 Hz

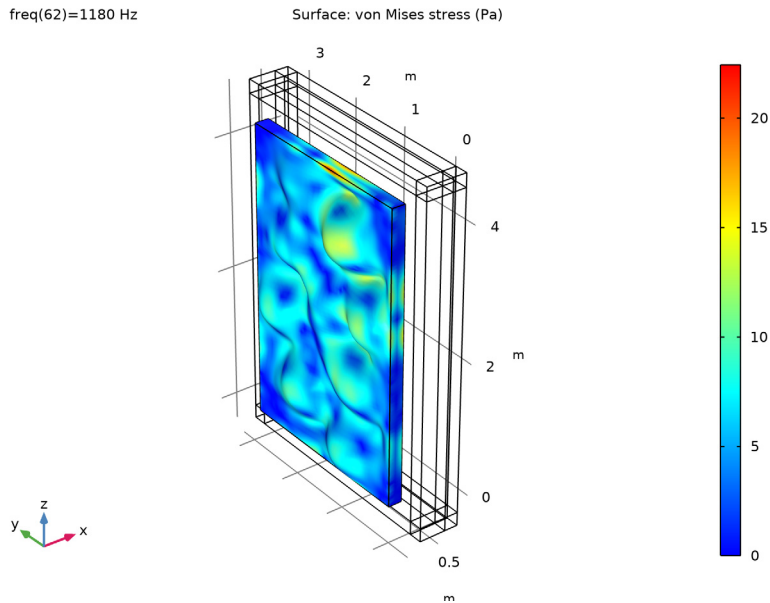

Next, create plots of the incident and transmitted intensity, the displacement, as well as 1D plots of the STL.

### Incident Intensity

- 1 In the **Home** toolbar, click  **Add Plot Group** and choose **3D Plot Group**.
- 2 In the **Settings** window for **3D Plot Group**, type Incident Intensity in the **Label** text field.

### Surface 1

- 1 Right-click **Incident Intensity** and choose **Surface**.
- 2 In the **Settings** window for **Surface**, locate the **Expression** section.
- 3 In the **Expression** text field, type  $0.5 * I_{x\_room}$ .

### Selection 1

- 1 Right-click **Surface 1** and choose **Selection**.
- 2 Select Boundary 1 only.
- 3 In the **Incident Intensity** toolbar, click  **Plot**.

The plot is depicted at four frequencies in [Figure 4](#).

### *Transmitted Intensity*

- 1 In the **Home** toolbar, click  **Add Plot Group** and choose **3D Plot Group**.
- 2 In the **Settings** window for **3D Plot Group**, type Transmitted Intensity in the **Label** text field.

### *Surface 1*

- 1 Right-click **Transmitted Intensity** and choose **Surface**.
- 2 In the **Settings** window for **Surface**, locate the **Expression** section.
- 3 In the **Expression** text field, type `Ix_tr`.

### *Selection 1*

- 1 Right-click **Surface 1** and choose **Selection**.
- 2 Select Boundary 26 only.
- 3 In the **Transmitted Intensity** toolbar, click  **Plot**.  
The plot is depicted at four frequencies in [Figure 5](#).

### *Displacement*

- 1 In the **Home** toolbar, click  **Add Plot Group** and choose **3D Plot Group**.
- 2 In the **Settings** window for **3D Plot Group**, type Displacement in the **Label** text field.
- 3 Click to expand the **Title** section. From the **Title type** list, choose **Manual**.
- 4 Select the **Allow evaluation of expressions** check box.
- 5 In the **Parameter indicator** text field, type `f = eval(freq) Hz`.
- 6 Locate the **Plot Settings** section. Clear the **Plot dataset edges** check box.
- 7 Locate the **Color Legend** section. Select the **Show units** check box.

### *Surface 1*

- 1 Right-click **Displacement** and choose **Surface**.
- 2 In the **Settings** window for **Surface**, locate the **Expression** section.
- 3 In the **Expression** text field, type `solid.disp`.

### *Deformation 1*

Right-click **Surface 1** and choose **Deformation**.

### *Filter 1*

- 1 In the **Model Builder** window, right-click **Surface 1** and choose **Filter**.
- 2 In the **Settings** window for **Filter**, locate the **Element Selection** section.
- 3 In the **Logical expression for inclusion** text field, type `z>1.5[m]`.

### Surface 2

- 1 In the **Model Builder** window, right-click **Displacement** and choose **Surface**.
- 2 In the **Settings** window for **Surface**, locate the **Coloring and Style** section.
- 3 From the **Color table** list, choose **Wave**.
- 4 Select the **Symmetrize color range** check box.

### Selection 1

- 1 Right-click **Surface 2** and choose **Selection**.
- 2 Select Boundary 53 only.
- 3 In the **Displacement** toolbar, click  **Plot**.

The plot is depicted at four frequencies in [Figure 6](#).

Postprocessing the STL variables is time consuming, so in order to save time setting up the next three plots (avoiding automatic plotting when formatting the plots), enable the **Only plot when requested** option.

- 4 In the **Model Builder** window, click **Results**.
- 5 In the **Settings** window for **Results**, locate the **Update of Results** section.
- 6 Select the **Only plot when requested** check box.

### STL: P\_in/P\_tr (octaves)

- 1 In the **Home** toolbar, click  **Add Plot Group** and choose **ID Plot Group**.
- 2 In the **Settings** window for **ID Plot Group**, type STL: P\_in/P\_tr (octaves) in the **Label** text field.
- 3 Click to expand the **Title** section. From the **Title type** list, choose **Manual**.
- 4 In the **Title** text area, type Sound Transmission Loss (octaves).
- 5 Locate the **Plot Settings** section. Select the **x-axis label** check box.
- 6 In the associated text field, type  $f$  (Hz).
- 7 Select the **y-axis label** check box.
- 8 In the associated text field, type STL (dB).
- 9 Locate the **Legend** section. From the **Position** list, choose **Lower left**.

### Octave Band 1

- 1 In the **STL: P\_in/P\_tr (octaves)** toolbar, click  **More Plots** and choose **Octave Band**.
- 2 In the **Settings** window for **Octave Band**, locate the **Selection** section.
- 3 From the **Geometric entity level** list, choose **Global**.
- 4 Locate the **y-Axis Data** section. From the **Expression type** list, choose **Power**.

- 5 In the **Expression** text field, type P\_in.
- 6 In the **Power reference** text field, type P\_tr.
- 7 Locate the **Plot** section. From the **Style** list, choose **Continuous**.

#### *Octave Band 2*

- 1 Right-click **Octave Band 1** and choose **Duplicate**.
- 2 In the **Settings** window for **Octave Band**, locate the **Plot** section.
- 3 From the **Style** list, choose **Octave bands**.
- 4 Click to expand the **Coloring and Style** section. From the **Type** list, choose **Outline**.

#### *Global 1*

- 1 In the **Model Builder** window, right-click **STL: P\_in/P\_tr (octaves)** and choose **Global**.
- 2 In the **Settings** window for **Global**, locate the **Data** section.
- 3 From the **Dataset** list, choose **Study 1/Solution 1 (sol1)**.
- 4 From the **Parameter selection (freq)** list, choose **From list**.
- 5 From the **Parameter values** list select the frequencies from 100 Hz to 1180 Hz, where the measurements are valid.
- 6 Locate the **y-Axis Data** section. In the table, enter the following settings:

Expression	Unit	Description
STL_typical(freq)		Typical Measurements

- 7 In the **STL: P\_in/P\_tr (octaves)** toolbar, click  **Plot**.

The STL plot, with the octave evaluation, is depicted in [Figure 7](#).

#### *STL: P\_in/P\_tr (1/3 octaves)*

- 1 Right-click **STL: P\_in/P\_tr (octaves)** and choose **Duplicate**.
- 2 In the **Settings** window for **ID Plot Group**, type STL: P\_in/P\_tr (1/3 octaves) in the **Label** text field.
- 3 Locate the **Title** section. In the **Title** text area, type Sound Transmission Loss (1/3 octaves).

#### *Octave Band 2*

- 1 In the **Model Builder** window, expand the **STL: P\_in/P\_tr (1/3 octaves)** node, then click **Octave Band 2**.
- 2 In the **Settings** window for **Octave Band**, locate the **Plot** section.
- 3 From the **Style** list, choose **1/3 octave bands**.



### Global 2

- 1 In the **Model Builder** window, right-click **STL: P\_in/P\_tr (1/3 octaves)** and choose **Global**.
- 2 In the **Settings** window for **Global**, locate the **Data** section.
- 3 From the **Dataset** list, choose **Study 1/Solution 1 (sol1)**.
- 4 From the **Parameter selection (freq)** list, choose **From list**.
- 5 From the **Parameter values** list select the frequencies from 200 Hz to 1180 Hz, to plot Sharp's equation here.
- 6 Locate the **y-Axis Data** section. In the table, enter the following settings:

Expression	Unit	Description
$10 \cdot \log_{10}(1 + (\pi \cdot \text{freq} \cdot m / (\rho \cdot c_0))^2) - 5.5$		Sharp's Equation (mass law)

- 7 In the **STL: P\_in/P\_tr (1/3 octaves)** toolbar, click  **Plot**.

The STL plot, with the 1/3 octave evaluation and Sharp's equation, is depicted in [Figure 8](#).

### Incident Power (three methods)

- 1 In the **Home** toolbar, click  **Add Plot Group** and choose **ID Plot Group**.
- 2 In the **Settings** window for **ID Plot Group**, type Incident Power (three methods) in the **Label** text field.
- 3 Click to collapse the **Title** section. Click to expand the **Title** section. From the **Title type** list, choose **Manual**.
- 4 In the **Title** text area, type Incident Power: Three Computation Methods.
- 5 Locate the **Plot Settings** section. Select the **x-axis label** check box.
- 6 In the associated text field, type  $f$  (Hz).
- 7 Select the **y-axis label** check box.
- 8 In the associated text field, type Power:  $P_{in}$  (W).
- 9 Locate the **Axis** section. Select the **x-axis log scale** check box.
- 10 Select the **y-axis log scale** check box.
- 11 Locate the **Legend** section. From the **Position** list, choose **Lower right**.

### Global 1

- 1 Right-click **Incident Power (three methods)** and choose **Global**.
- 2 In the **Settings** window for **Global**, locate the **y-Axis Data** section.

3 In the table, enter the following settings:



Expression	Unit	Description
P_in	W	Incident power (half space)
P_in_proom	W	Incident power (room RMS pressure average)
P_in_theo	W	Incident power (theoretical)

4 In the **Incident Power (three methods)** toolbar, click  **Plot**.

The power plot is depicted in [Figure 9](#).

Proceed and add a second study to perform an eigenfrequency analysis of the structure (the wall). When adding the study de-select the acoustic and the multiphysics coupling. In the analysis setup look for the first 3 modes.

#### ADD STUDY

- 1 In the **Home** toolbar, click  **Add Study** to open the **Add Study** window.
- 2 Go to the **Add Study** window.
- 3 Find the **Studies** subsection. In the **Select Study** tree, select **General Studies> Eigenfrequency**.
- 4 Find the **Physics interfaces in study** subsection. In the table, clear the **Solve** check box for **Pressure Acoustics, Frequency Domain (acpr)**.
- 5 Find the **Multiphysics couplings in study** subsection. In the table, clear the **Solve** check box for **Acoustic-Structure Boundary I (asb1)**.
- 6 Click **Add Study** in the window toolbar.
- 7 In the **Home** toolbar, click  **Add Study** to close the **Add Study** window.

#### STUDY 2

*Step 1: Eigenfrequency*

- 1 In the **Settings** window for **Eigenfrequency**, locate the **Study Settings** section.
- 2 Select the **Desired number of eigenfrequencies** check box.
- 3 In the associated text field, type 3.
- 4 From the **Eigenfrequency search method around shift** list, choose **Larger real part**.
- 5 In the **Home** toolbar, click  **Compute**.

## RESULTS

### *Mode Shape (solid)*

The first three structural modes are depicted in [Figure 10](#). A table with the eigenvalues is also automatically generated. To see the table select the **Eigenfrequencies (Study 2)** evaluation group node.

Finally, disable the **Only plot when requested** option for the results. Turn **On** the option to **Save plot data** in order to avoid re-render the STL curves once the model is opened again.

- 1 In the **Model Builder** window, click **Results**.
- 2 In the **Settings** window for **Results**, locate the **Update of Results** section.
- 3 Clear the **Only plot when requested** check box.
- 4 Locate the **Save Data in the Model** section. From the **Save plot data** list, choose **On**.

