



Piezoelectric MEMS Speaker

Introduction

This model analyzes a piezoelectric microelectromechanical system (MEMS) speaker presented in Ref. 1, 2, and 3. The speaker, composed of four triangular membranes, uses a layer of lead zirconate titanate (PZT) material with two electrodes on opposing faces as actuator. The triangular membranes are separated by narrow gaps of air that allow for larger deflections of the membrane. The thermoviscous losses in the gaps limit the airflow, thus allowing the four actuators to behave acoustically as a single membrane.

Model Definition

The PZT material, which seats on top of a silicon layer, is excited with a voltage that makes the membrane move and create sound. Figure 1 shows a schematic view of the speaker. The four triangular membranes are separated by narrow gaps of air. The acoustic behavior in the gaps (shown in green) is modeled with the full thermoviscous acoustic formulation using the *Thermoviscous Acoustics, Frequency Domain* physics interface.

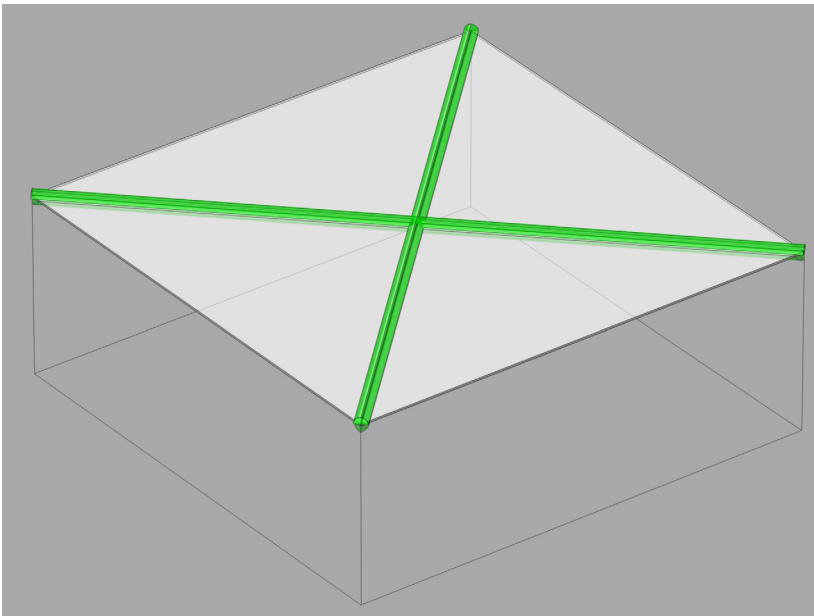

Figure 1: Schematic representation of the piezoelectric MEMS speaker, with the areas where thermoviscous losses are relevant highlighted in green.

The four triangular membranes form a square with approximately 4 mm sides. The membrane is backed by a back volume of roughly 24 mm³. The volume acts as a spring (compliance) changing the acoustic properties of the speaker.

The tutorial takes advantage of the existing symmetries to model only a quarter of the speaker and represent the rest by using symmetry features. The speaker is located in an infinite baffle and uses a voltage difference acting between the faces of the PZT material to create vibrations that will propagate as acoustic perturbations. The acting voltage contains a constant component, usually called the bias voltage (DC) and an alternating voltage (AC or perturbation contribution), following

$$V_0 = V_{DC} + V_{AC} \cos(2\pi f \cdot t) \quad (1)$$

where V_0 is the terminal voltage, V_{DC} is the bias voltage, V_{AC} is the alternating voltage, f is the driving frequency, and t is the time. Due to the piezoelectric effect, the PZT material excited with this voltage will induce deformations in the membranes, which are captured through the *Solid Mechanics* physics.

The air gap between the membranes is 9 μm wide, and this gap is in the order of magnitude of the viscous boundary layer in air (at the frequencies studied here). The boundary layer thickness is given by

$$\delta_v = \sqrt{\frac{2\mu}{\omega\rho}} = 0.22 \text{ mm} \cdot \sqrt{\frac{100 \text{ Hz}}{f}} \quad (2)$$

where δ_v is the viscous boundary layer thickness (in the second equation the material properties of air have been entered). At the resonance frequency of 9 kHz, δ_v takes the value of 23.2 μm, on the same order of magnitude as the gap. This indicates that the thermoviscous losses are likely to modify the response of the speaker at the driving frequency. To capture the losses, the *Thermoviscous Acoustics, Frequency Domain* is used to model the acoustics in the air gaps and a small surrounding volume.

The rest of the acoustic domains are captured using the *Pressure Acoustics, Frequency Domain* physics interface. Here the thermoviscous boundary layers are captured through the *Thermoviscous Boundary Layer Impedance* boundary feature. The open domain conditions surrounding the speaker is modeled with a *Perfectly Matched Layer*. The *Exterior Field Calculation* feature is used to obtain the acoustic field at any point in the exterior domain.

Results and Discussion

The harmonic component of the stress in the membrane is shown in [Figure 2](#). Note how the excitation produces displacement perpendicular to the plane of the membrane through bending.

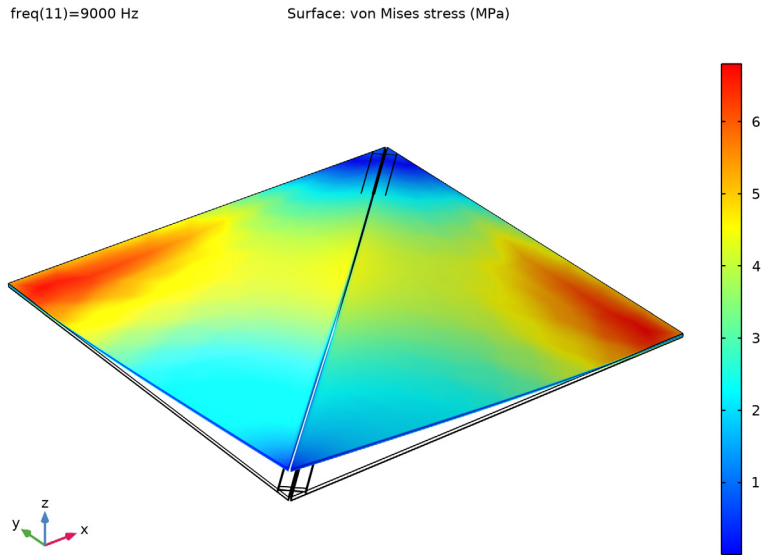

Figure 2: Harmonic part of the von Mises stress at the membranes.

[Figure 3](#) shows the distribution of the electric potential in the membranes. The electric potential variation takes place almost exclusively in the vertical direction. As seen in [Figure 4](#), the small dimensions of the speaker means that the computational domain does not even capture a full wavelength at the highest frequency analyzed, 20 kHz.

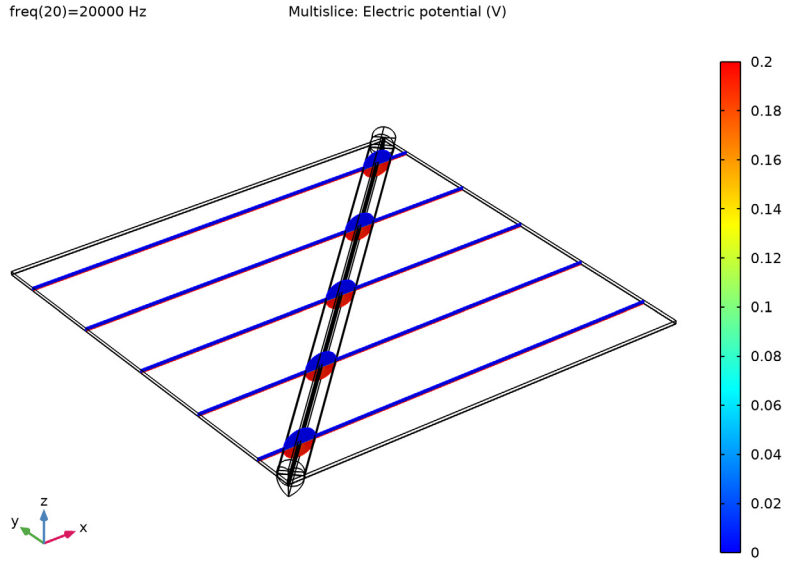

Figure 3: Harmonic variation of the electric potential.

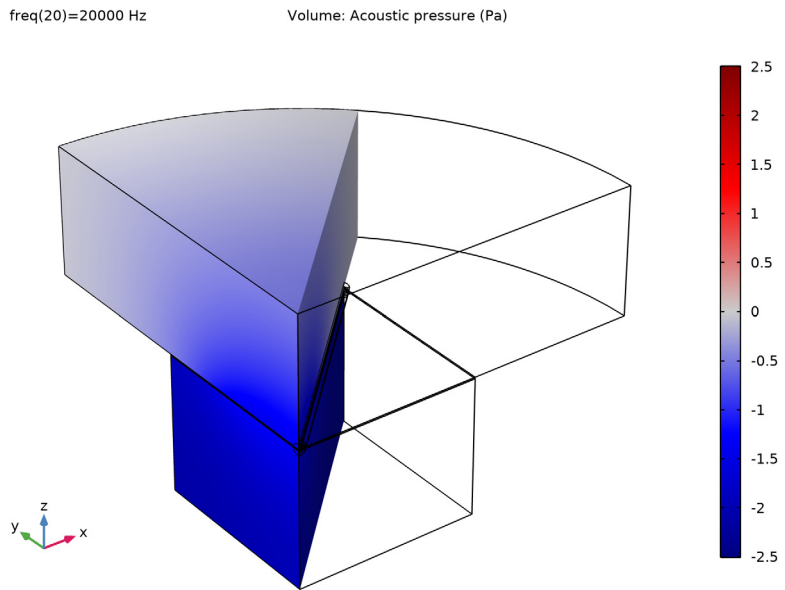

Figure 4: Total acoustic pressure at 20 kHz.

Figure 5 shows the instantaneous acoustic velocity around the air gaps. The high velocity gradients present in the air gaps create viscous shear losses that damp the natural frequency of the membranes. Note that the section shown is close to the center of the membrane, so the complete section has a velocity larger than 0.

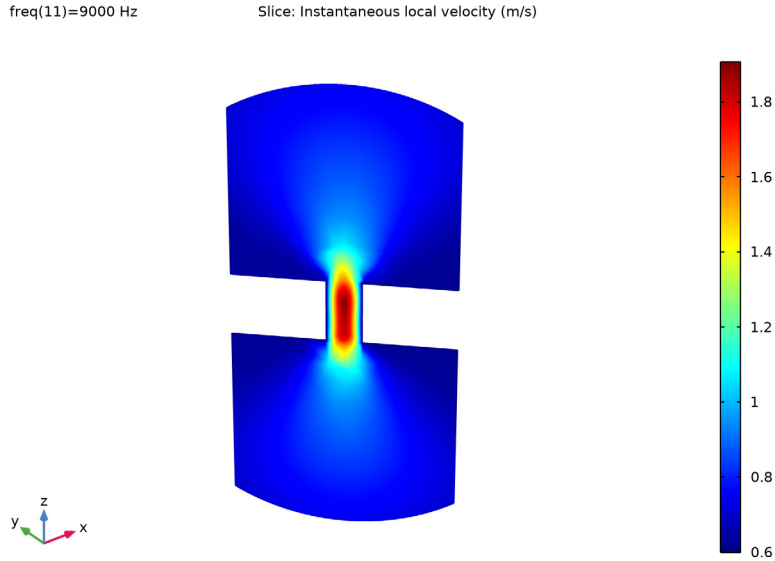

Figure 5: Instantaneous local velocity at 9 kHz.

The logarithmic thermoviscous losses, shown in Figure 6 demonstrate how most of the thermoviscous losses are concentrated in the air gap, suggesting that a *Narrow Region Acoustics* feature (using the slit option) in *Pressure Acoustics* could potentially be enough to capture the losses caused by the air gap.

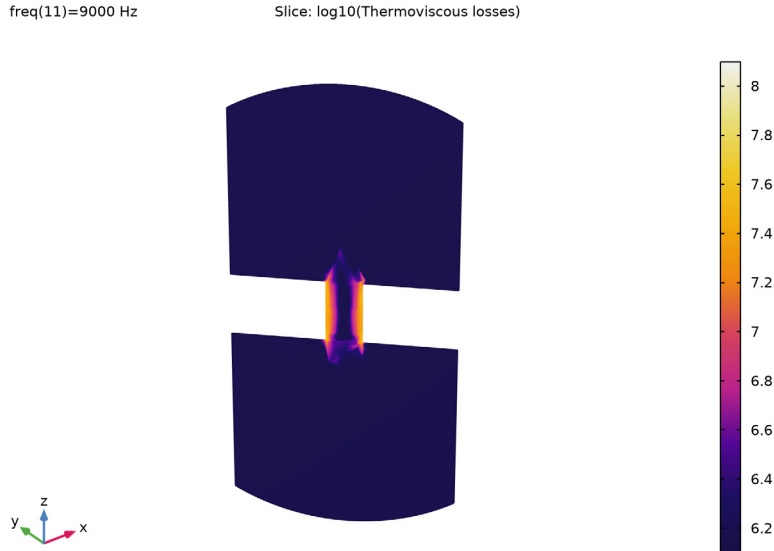

Figure 6: Logarithmic volumetric thermoviscous losses around the air gap.

Figure 7 shows the magnitude and phase of the electric impedance of the speaker. Note how the lossless model predicts a highly undamped resonance at a lower frequency. The results of the model with the narrow region acoustics closely matched those in the model, both in frequency and damping characteristics. Using narrow region acoustics can be a good solution when requiring short running times in the first phase of the design. The detailed thermoviscous simulation can den be used for a high fidelity verification. The electric impedance shows excellent agreement with the experimental results in Ref. 1, 2, and 3.

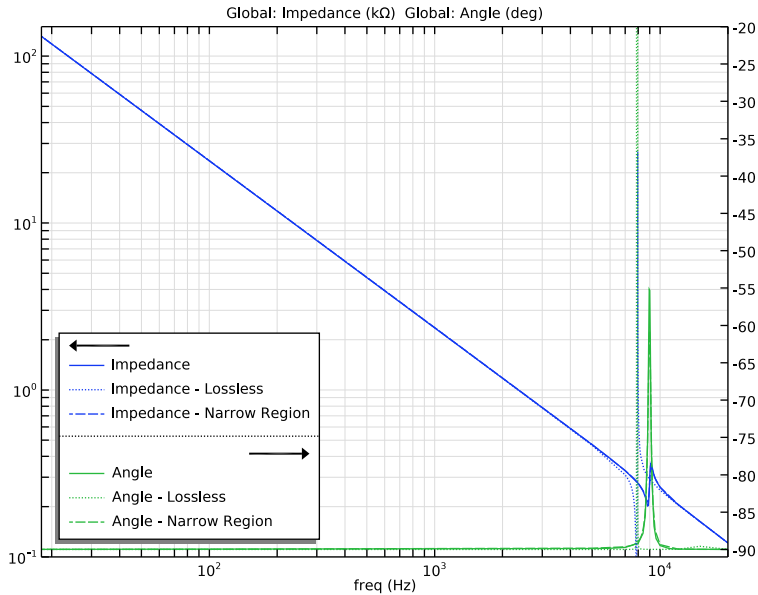

Figure 7: Electric impedance of the speaker, magnitude and phase. The figure also includes the results of a lossless model (pure Pressure Acoustics) and a Pressure Acoustics models with Narrow Region Acoustics.

Notes About the COMSOL Implementation

The model uses the *Small-Signal Analysis* to analyze the static effect of the bias voltage and the harmonic perturbation caused by the alternating voltage.

The model uses the *Added Mass* feature under *Solid Mechanics* to represent the masses of the electrodes, which have a significant effect on the resonance frequencies.

The model uses a *Boundary Load* to manually couple the *Solid Mechanics* and the *Pressure Acoustics, Frequency Domain* physics. This manual coupling is done to be able to capture the effects of the thermoviscous boundary layer impedance in those areas where there is a coupling between the two physics. The *Thermoviscous Boundary Layer Impedance* is used to capture the boundary layer losses in those boundaries that are in contact with the *Pressure Acoustics, Frequency Domain* physics.

The *Thermoviscous Boundary Layer Impedance* is an inexpensive way to include the effects of the thermoviscous boundary layers. The condition is valid for models where

there is no overlap between boundary layers, as it is the case for the current model. A small overlap will be present at the corners of the back volume but this effect is minimal.

References

1. F. Stoppel, A.Männchen, F. Niekiet, D. Beer, T. Giese, and B. Wagner, “New integrated full-range MEMS speaker for in-ear applications,” *IEEE Micro Electro Mechanical Systems (MEMS)*, 2018.
2. A.Männchen, F. Stoppel, D. Beer, F. Niekiet, and B. Wagner, “In-ear headphone system with piezoelectric MEMS driver,” *Audio Engineering Society*, 2018.
3. A.Männchen, F. Stoppel, T. Brocks, F. Niekiet, D. Beer, and B. Wagner, “Design and electroacoustic analysis of a piezoelectric MEMS in-ear headphone,” *Audio Engineering Society*, 2018.

Application Library path: Acoustics_Module/Electroacoustic_Transducers/
piezo_mems_speaker

Modeling Instructions

From the **File** menu, choose **New**.

NEW

In the **New** window, click  **Model Wizard**.

MODEL WIZARD

- 1 In the **Model Wizard** window, click  **3D**.
- 2 In the **Select Physics** tree, select **Structural Mechanics>Electromagnetics-Structure Interaction>Piezoelectricity>Piezoelectricity, Solid**.
- 3 Click **Add**.
- 4 In the **Select Physics** tree, select **Acoustics>Pressure Acoustics>Pressure Acoustics, Frequency Domain (acpr)**.
- 5 Click **Add**.
- 6 In the **Select Physics** tree, select **Acoustics>Thermoviscous Acoustics>Thermoviscous Acoustics, Frequency Domain (ta)**.

7 Click **Add**.

8 Click  **Study**.

9 In the **Select Study** tree, select **Preset Studies for Selected Physics Interfaces> Electrostatics>Small-Signal Analysis, Frequency Domain**.

10 Click  **Done**.

GEOMETRY I

Adjust the units of the model to μm .

1 In the **Model Builder** window, under **Component 1 (comp1)** click **Geometry 1**.

2 In the **Settings** window for **Geometry**, locate the **Units** section.

3 From the **Length unit** list, choose μm .

Import the parameters from an external file. This file contains parameters like dimensions, maximum frequency and voltage that define the current model.

GLOBAL DEFINITIONS

Parameters 1

1 In the **Model Builder** window, under **Global Definitions** click **Parameters 1**.

2 In the **Settings** window for **Parameters**, locate the **Parameters** section.

3 Click  **Load from File**.

4 Browse to the model's Application Libraries folder and double-click the file `piezo_mems_speaker_parameters.txt`.

Import the geometry from an external file.

GEOMETRY I

1 In the **Geometry** toolbar, click  **Insert Sequence**.

2 Browse to the model's Application Libraries folder and double-click the file `piezo_mems_speaker_geom_sequence.mph`.

3 In the **Geometry** toolbar, click  **Build All**.

4 Click the  **Show Grid** button in the **Graphics** toolbar.

- 5 Click the  **Transparency** button in the **Graphics** toolbar.
The picture should like this.

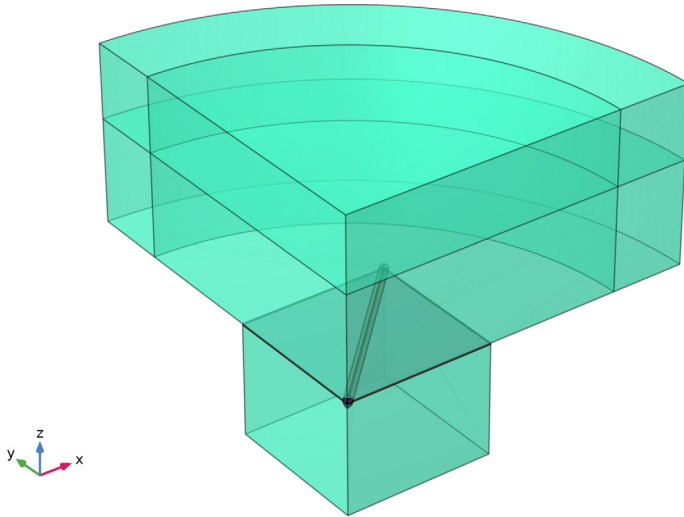

- 6 Click the  **Transparency** button in the **Graphics** toolbar.

DEFINITIONS

Linear Extrusion 1 (linext1)

- 1 In the **Definitions** toolbar, click  **Nonlocal Couplings** and choose **Linear Extrusion**.
We will use the **Linear Extrusion** feature to generate result plots later on.
- 2 In the **Settings** window for **Linear Extrusion**, locate the **Source Selection** section.
- 3 From the **Geometric entity level** list, choose **Edge**.
- 4 Select Edges 36, 91, and 141 only.
- 5 Locate the **Source Vertices** section. Select the **Activate Selection** toggle button.
- 6 Select Point 11 only.
- 7 Select the **Activate Selection** toggle button.
- 8 Select Point 65 only.
- 9 Locate the **Destination Vertices** section. Select the **Activate Selection** toggle button.
- 10 Select Point 11 only.

11 Select the  **Activate Selection** toggle button.

12 Select Point 65 only.

Perfectly Matched Layer 1 (pml1)

1 In the **Definitions** toolbar, click  **Perfectly Matched Layer**.

2 In the **Settings** window for **Perfectly Matched Layer**, locate the **Domain Selection** section.

3 From the **Selection** list, choose **PML Domains**.

4 Locate the **Geometry** section. From the **Type** list, choose **Cylindrical**.

5 Locate the **Scaling** section. From the **Physics** list, choose **Pressure Acoustics, Frequency Domain (acpr)**.

GEOMETRY 1

In the **Model Builder** window, collapse the **Component 1 (comp1)>Geometry 1** node.

MATERIALS

Apply materials to the model. Use the Air and Silicon materials from the Built-in category and the PZT material from the Piezoelectric category.

ADD MATERIAL

1 In the **Home** toolbar, click  **Add Material** to open the **Add Material** window.

2 Go to the **Add Material** window.

3 In the tree, select **Built-in>Air**.

4 Click **Add to Component** in the window toolbar.

5 In the tree, select **Piezoelectric>Lead Zirconate Titanate (PZT-4)**.

6 Click **Add to Component** in the window toolbar.

7 In the tree, select **Built-in>Silicon**.

8 Click **Add to Component** in the window toolbar.

9 In the **Home** toolbar, click  **Add Material** to close the **Add Material** window.

MATERIALS

Silicon (mat3)

1 In the **Settings** window for **Material**, locate the **Geometric Entity Selection** section.

2 From the **Selection** list, choose **Silicon Domains**.

Lead Zirconate Titanate (PZT-4) (mat2)

1 In the **Model Builder** window, click **Lead Zirconate Titanate (PZT-4) (mat2)**.

- 2 In the **Settings** window for **Material**, locate the **Geometric Entity Selection** section.
- 3 From the **Selection** list, choose **PZT Domains**.

Air (mat1)

- 1 In the **Model Builder** window, click **Air (mat1)**.
- 2 In the **Settings** window for **Material**, locate the **Geometric Entity Selection** section.
- 3 From the **Selection** list, choose **Air Domains**.

SOLID MECHANICS (SOLID)



- 1 In the **Model Builder** window, under **Component 1 (comp1)** click **Solid Mechanics (solid)**.
- 2 In the **Settings** window for **Solid Mechanics**, locate the **Domain Selection** section.
- 3 From the **Selection** list, choose **Structural Domains**.

Add the **Piezoelectric Material** feature to the PZT domain so the piezoelectric forces are computed correctly.

Piezoelectric Material 1

- 1 In the **Model Builder** window, under **Component 1 (comp1)>Solid Mechanics (solid)** click **Piezoelectric Material 1**.
- 2 In the **Settings** window for **Piezoelectric Material**, locate the **Domain Selection** section.
- 3 From the **Selection** list, choose **PZT Domains**.

Fixed Constraint 1

- 1 In the **Physics** toolbar, click  **Boundaries** and choose **Fixed Constraint**.
- 2 In the **Settings** window for **Fixed Constraint**, locate the **Boundary Selection** section.
- 3 Click  **Clear Selection**.
- 4 Select Boundaries 45, 46, 111, 113, 142–144, and 146 only.

Symmetry 1

- 1 In the **Physics** toolbar, click  **Boundaries** and choose **Symmetry**.
- 2 In the **Settings** window for **Symmetry**, locate the **Boundary Selection** section.
- 3 From the **Selection** list, choose **Symmetric Boundaries**.

Add the mass representing the electrodes as this mass influences the eigenfrequencies of the system.

Added Mass - Pt Electrode

- 1 In the **Physics** toolbar, click  **Boundaries** and choose **Added Mass**.

- 2 In the **Settings** window for **Added Mass**, type Added Mass - Pt Electrode in the **Label** text field.
- 3 Locate the **Boundary Selection** section. From the **Selection** list, choose **Ground**.
- 4 Locate the **Added Mass** section. In the ρ_A text field, type rho_pt*th_pt.

Added Mass - Au Electrode

- 1 In the **Physics** toolbar, click  **Boundaries** and choose **Added Mass**.
- 2 In the **Settings** window for **Added Mass**, type Added Mass - Au Electrode in the **Label** text field.
- 3 Locate the **Boundary Selection** section. From the **Selection** list, choose **Terminal**.
- 4 Locate the **Added Mass** section. In the ρ_A text field, type rho_au*th_au.

Boundary Load I

- 1 In the **Physics** toolbar, click  **Boundaries** and choose **Boundary Load**.
- 2 Select Boundaries 39, 43, 93, and 97 only.
- 3 In the **Settings** window for **Boundary Load**, locate the **Force** section.
- 4 From the **Load type** list, choose **Pressure**.
This adds the acoustic load as a boundary load.
- 5 In the p text field, type acpr.p_t.

To reduce the computation time of the model, we will only model the electrostatics effects in the membrane and the air around the gap.

ELECTROSTATIC (ES)

- 1 In the **Model Builder** window, under **Component 1 (comp1)** click **Electrostatics (es)**.
- 2 In the **Settings** window for **Electrostatics**, locate the **Domain Selection** section.
- 3 From the **Selection** list, choose **Electrostatics Domains**.

Charge Conservation, Piezoelectric I

- 1 In the **Model Builder** window, under **Component 1 (comp1)**>**Electrostatics (es)** click **Charge Conservation, Piezoelectric I**.
- 2 In the **Settings** window for **Charge Conservation, Piezoelectric**, locate the **Domain Selection** section.
- 3 From the **Selection** list, choose **PZT Domains**.

Ground I

- 1 In the **Physics** toolbar, click  **Boundaries** and choose **Ground**.

- 2 In the **Settings** window for **Ground**, locate the **Boundary Selection** section.
- 3 From the **Selection** list, choose **Ground**.

Terminal 1

- 1 In the **Physics** toolbar, click  **Boundaries** and choose **Terminal**.
- 2 In the **Settings** window for **Terminal**, locate the **Boundary Selection** section.
- 3 From the **Selection** list, choose **Terminal**.
- 4 Locate the **Terminal** section. From the **Terminal type** list, choose **Voltage**.
- 5 In the V_0 text field, type $V_{DC} + \text{linper}(V_{AC})$.

The speaker has a bias voltage that will be considered in the **Stationary** step of the analysis. Use the `linper` operator to discern the variable part of the voltage that will be used in the **Frequency Domain Perturbation** step.

PRESSURE ACOUSTICS, FREQUENCY DOMAIN (ACPR)

- 1 In the **Model Builder** window, under **Component 1 (comp1)** click **Pressure Acoustics, Frequency Domain (acpr)**.
- 2 In the **Settings** window for **Pressure Acoustics, Frequency Domain**, locate the **Domain Selection** section.
- 3 From the **Selection** list, choose **Pressure Acoustics Domains**.
- 4 Click to expand the **Discretization** section.

Symmetry 1

- 1 In the **Physics** toolbar, click  **Boundaries** and choose **Symmetry**.
- 2 In the **Settings** window for **Symmetry**, locate the **Boundary Selection** section.
- 3 From the **Selection** list, choose **Symmetric Boundaries**.

Exterior Field Calculation 1

- 1 In the **Physics** toolbar, click  **Boundaries** and choose **Exterior Field Calculation**.
- 2 In the **Settings** window for **Exterior Field Calculation**, locate the **Boundary Selection** section.
- 3 From the **Selection** list, choose **Exterior Field Boundaries**.
- 4 Locate the **Exterior Field Calculation** section. From the **Condition in the $x = x^0$ plane** list, choose **Symmetric/Infinite sound hard boundary**.
- 5 From the **Condition in the $y = y^0$ plane** list, choose **Symmetric/Infinite sound hard boundary**.

- From the **Condition in the $z = z^0$ plane** list, choose **Symmetric/Infinite sound hard boundary**.

Thermoviscous Boundary Layer Impedance 1

- In the **Physics** toolbar, click  **Boundaries** and choose **Thermoviscous Boundary Layer Impedance**.
- In the **Settings** window for **Thermoviscous Boundary Layer Impedance**, locate the **Fluid Properties** section.
- From the **Fluid material** list, choose **Air (mat1)**.
- Select Boundaries 3, 44, 47, and 141 only.

Thermoviscous Boundary Layer Impedance 2

- In the **Physics** toolbar, click  **Boundaries** and choose **Thermoviscous Boundary Layer Impedance**.
- Select Boundaries 39, 43, 93, and 97 only.
- In the **Settings** window for **Thermoviscous Boundary Layer Impedance**, locate the **Fluid Properties** section.
- From the **Fluid material** list, choose **Air (mat1)**.
Now add the solid velocity to make the manual coupling.
- Locate the **Mechanical Condition** section. From the **Mechanical condition** list, choose **Velocity**.
- Specify the \mathbf{v}_0 vector as

solid.u_tX	x
solid.u_tY	y
solid.u_tZ	z

THERMOVISCOUS ACOUSTICS, FREQUENCY DOMAIN (TA)

- In the **Model Builder** window, under **Component 1 (comp1)** click **Thermoviscous Acoustics, Frequency Domain (ta)**.
- In the **Settings** window for **Thermoviscous Acoustics, Frequency Domain**, locate the **Domain Selection** section.
- From the **Selection** list, choose **Thermoviscous Domains**.

Symmetry 1

- In the **Physics** toolbar, click  **Boundaries** and choose **Symmetry**.
- In the **Settings** window for **Symmetry**, locate the **Boundary Selection** section.

- 3 From the **Selection** list, choose **Symmetric Boundaries**.

Add the missing multiphysics interfaces that will handle the interaction between the different physics.

MULTIPHYSICS

Thermoviscous Acoustic-Structure Boundary 1 (tsb1)

- 1 In the **Physics** toolbar, click  **Multiphysics Couplings** and choose **Boundary>Thermoviscous Acoustic-Structure Boundary**.

Turn on the advanced physics to change the Mechanical constraint type to Weak Constraint. This increases the stability of the model.

- 2 Click the  **Show More Options** button in the **Model Builder** toolbar.
- 3 In the **Show More Options** dialog box, in the tree, select the check box for the node **Physics>Advanced Physics Options**.
- 4 Click **OK**.
- 5 In the **Settings** window for **Thermoviscous Acoustic-Structure Boundary**, locate the **Boundary Selection** section.
- 6 From the **Selection** list, choose **All boundaries**.
- 7 Click to expand the **Constraint Settings** section. From the **Mechanical constraint type** list, choose **Weak constraint**.



Acoustic-Thermoviscous Acoustic Boundary 1 (atb1)

- 1 In the **Physics** toolbar, click  **Multiphysics Couplings** and choose **Boundary>Acoustic-Thermoviscous Acoustic Boundary**.
- 2 In the **Settings** window for **Acoustic-Thermoviscous Acoustic Boundary**, locate the **Boundary Selection** section.
- 3 From the **Selection** list, choose **All boundaries**.

In the following steps, create a swept mesh. This will reduce the computational cost of the analysis.

MESH 1

Mapped 1

- 1 In the **Mesh** toolbar, click  **Boundary** and choose **Mapped**.
- 2 Click the  **Wireframe Rendering** button in the **Graphics** toolbar.
- 3 Select Boundaries 36, 73, 81, 90, and 121 only.

- 4 In the **Settings** window for **Mapped**, click to expand the **Reduce Element Skewness** section.
- 5 Select the **Adjust edge mesh** check box.

Size 1

- 1 Right-click **Mapped 1** and choose **Size**.
- 2 In the **Settings** window for **Size**, locate the **Element Size** section.
- 3 Click the **Custom** button.
- 4 Locate the **Element Size Parameters** section. Select the **Maximum element size** check box.
- 5 In the associated text field, type `dvisc*4`.

Distribution 1

- 1 In the **Model Builder** window, right-click **Mapped 1** and choose **Distribution**.
- 2 Select Edge 35 only.
- 3 In the **Settings** window for **Distribution**, locate the **Distribution** section.
- 4 From the **Distribution type** list, choose **Predefined**.
- 5 In the **Element ratio** text field, type 2.
- 6 Select the **Symmetric distribution** check box.

Distribution 2

- 1 Right-click **Mapped 1** and choose **Distribution**.
- 2 Select Edge 102 only.
- 3 In the **Settings** window for **Distribution**, locate the **Distribution** section.
- 4 From the **Distribution type** list, choose **Predefined**.
- 5 In the **Element ratio** text field, type 3.

Distribution 3

- 1 Right-click **Mapped 1** and choose **Distribution**.
- 2 Select Edge 81 only.
- 3 In the **Settings** window for **Distribution**, locate the **Distribution** section.
- 4 From the **Distribution type** list, choose **Predefined**.
- 5 In the **Element ratio** text field, type 3.
- 6 Select the **Reverse direction** check box.

Distribution 4

- 1 Right-click **Mapped 1** and choose **Distribution**.
- 2 Select Edges 72 and 141 only.

- 3 In the **Settings** window for **Distribution**, locate the **Distribution** section.
- 4 In the **Number of elements** text field, type 3.

Size

- 1 In the **Model Builder** window, click **Size**.
- 2 In the **Settings** window for **Size**, locate the **Element Size** section.
- 3 Click the **Custom** button.
- 4 Locate the **Element Size Parameters** section. In the **Maximum element size** text field, type $\lambda_{\min}/6$.
- 5 In the **Minimum element size** text field, type $d_{\text{visc}}/2$.
- 6 In the **Maximum element growth rate** text field, type 1.3.
- 7 Click  **Build All**.

Free Triangular I

- 1 In the **Mesh** toolbar, click  **Boundary** and choose **Free Triangular**.
- 2 Select Boundaries 16, 35, 43, 63, 97, 108, 130, and 140 only.

Size I

- 1 Right-click **Free Triangular I** and choose **Size**.
- 2 In the **Settings** window for **Size**, locate the **Element Size** section.
- 3 Click the **Custom** button.
- 4 Locate the **Element Size Parameters** section. Select the **Maximum element size** check box.
- 5 In the associated text field, type $d_{\text{visc}}*15$.
- 6 Select the **Maximum element growth rate** check box.
- 7 In the associated text field, type 1.2.

8 Click  **Build Selected**.

The mesh should look like this.

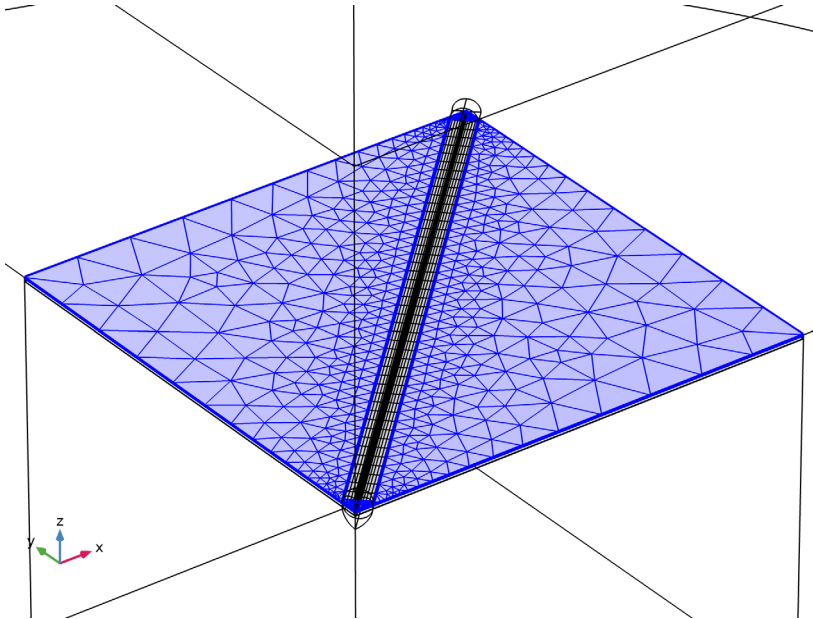

Swept 1

- 1 In the **Mesh** toolbar, click  **Swept**.
- 2 In the **Settings** window for **Swept**, locate the **Domain Selection** section.
- 3 From the **Geometric entity level** list, choose **Domain**.
- 4 Select Domains 3, 4, 8–13, 16, 17, 19–28, 30, and 32–37 only.

Distribution 1

- 1 Right-click **Swept 1** and choose **Distribution**.
- 2 Select Domains 4, 10, 11, 13, 17, 20, 23, 25, 27, 30, 33, 35, and 37 only.
- 3 In the **Settings** window for **Distribution**, locate the **Distribution** section.
- 4 In the **Number of elements** text field, type 2.

5 Click  **Build Selected**.

This mesh will be swept through the thermoviscous acoustics domains. The mesh should look like this.

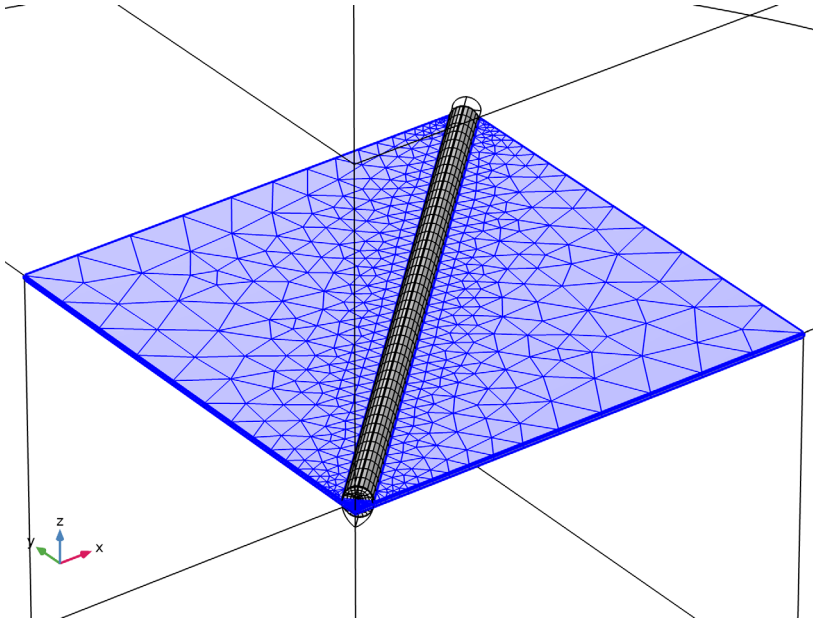

Free Tetrahedral 1

1 In the **Mesh** toolbar, click  **Free Tetrahedral**.

2 In the **Settings** window for **Free Tetrahedral**, locate the **Domain Selection** section.

3 From the **Geometric entity level** list, choose **Domain**.

4 Select Domains 1, 2, 5, 6, 29, and 31 only.

5 Click  **Build Selected**.

Swept 2

In the **Mesh** toolbar, click  **Swept**.

Distribution 1

1 Right-click **Swept 2** and choose **Distribution**.

2 In the **Settings** window for **Distribution**, locate the **Distribution** section.

3 In the **Number of elements** text field, type 8.

4 Click  **Build Selected**.

Boundary Layers 1

1 In the **Mesh** toolbar, click  **Boundary Layers**.

Add a boundary layer of a single element in the external field calculation boundary. This will guarantee that the gradients are computed correctly.

- 2 In the **Settings** window for **Boundary Layers**, locate the **Geometric Entity Selection** section.
- 3 From the **Geometric entity level** list, choose **Domain**.
- 4 Select Domain 6 only.
- 5 Click to expand the **Transition** section. Clear the **Smooth transition to interior mesh** check box.

Boundary Layer Properties

1 In the **Model Builder** window, click **Boundary Layer Properties**.

- 2 In the **Settings** window for **Boundary Layer Properties**, locate the **Boundary Selection** section.
- 3 From the **Selection** list, choose **Exterior Field Boundaries**.
- 4 Locate the **Boundary Layer Properties** section. In the **Number of boundary layers** text field, type 1.
- 5 Click  **Build Selected**.

STUDY 1

Step 1: Stationary

- 1 In the **Model Builder** window, under **Study 1** click **Step 1: Stationary**.
- 2 In the **Settings** window for **Stationary**, locate the **Physics and Variables Selection** section.
- 3 In the table, clear the **Solve for** check boxes for **Pressure Acoustics**, **Frequency Domain (acpr)** and **Thermoviscous Acoustics, Frequency Domain (ta)**.
- 4 In the table, clear the **Solve for** check boxes for **Thermoviscous Acoustic-Structure Boundary 1 (tsb1)** and **Acoustic-Thermoviscous Acoustic Boundary 1 (atb1)**.

Step 2: Frequency Domain Perturbation

- 1 In the **Model Builder** window, click **Step 2: Frequency Domain Perturbation**.
- 2 In the **Settings** window for **Frequency Domain Perturbation**, locate the **Study Settings** section.
- 3 In the **Frequencies** text field, type 10 5000 6000 7000 8000 8400 8600 8800 8875 8950 9000 9050 9125 9200 9400 9600 10000 11000 12000 20000.

Solution 1 (sol1)

- 1 In the **Study** toolbar, click  **Show Default Solver**.
- 2 In the **Model Builder** window, expand the **Solution 1 (sol1)** node.
- 3 In the **Model Builder** window, expand the **Study 1>Solver Configurations>Solution 1 (sol1)>Stationary Solver 2** node.
- 4 Right-click **Suggested Iterative Solver (GMRES with Direct Precon.) (pze1_tsbl_atbl)** and choose **Enable**.

The iterative solver is more efficient for large model like this one.

- 5 In the **Settings** window for **Iterative**, click  **Compute**.

RESULTS

Applied Loads (solid)

In the **Model Builder** window, under **Results** right-click **Applied Loads (solid)** and choose **Delete**.

Acoustic Pressure (ta)

- 1 In the **Model Builder** window, right-click **Acoustic Pressure (ta)** and choose **Delete**.

These plots are not relevant for the analysis.

Stress (solid)

- 1 In the **Model Builder** window, click **Stress (solid)**.
- 2 In the **Settings** window for **3D Plot Group**, locate the **Data** section.
- 3 From the **Parameter value (freq (Hz))** list, choose **9000**.
- 4 Click to expand the **Selection** section. From the **Geometric entity level** list, choose **Domain**.
- 5 From the **Selection** list, choose **Structural Domains**.
- 6 Select the **Apply to dataset edges** check box.

Surface 1

- 1 In the **Model Builder** window, expand the **Stress (solid)** node, then click **Surface 1**.
- 2 In the **Settings** window for **Surface**, locate the **Expression** section.
- 3 From the **Unit** list, choose **MPa**.
- 4 In the **Stress (solid)** toolbar, click  **Plot**.

The image should look like that in [Figure 2](#).

Electric Potential (es)

- 1 In the **Model Builder** window, click **Electric Potential (es)**.
- 2 In the **Settings** window for **3D Plot Group**, locate the **Selection** section.
- 3 From the **Geometric entity level** list, choose **Domain**.
- 4 From the **Selection** list, choose **Electrostatics Domains**.
- 5 Select the **Apply to dataset edges** check box.
- 6 In the **Electric Potential (es)** toolbar, click  **Plot**.

Multislice 1

- 1 In the **Model Builder** window, expand the **Electric Potential (es)** node, then click **Multislice 1**.
- 2 In the **Settings** window for **Multislice**, locate the **Multipane Data** section.
- 3 Find the **x-planes** subsection. In the **Planes** text field, type 0.
- 4 Find the **y-planes** subsection. In the **Planes** text field, type 5.
- 5 Find the **z-planes** subsection. In the **Planes** text field, type 0.
- 6 In the **Electric Potential (es)** toolbar, click  **Plot**.

The image should look like that in [Figure 3](#).

Acoustic Pressure (ta+acpr)

- 1 In the **Model Builder** window, under **Results** click **Acoustic Pressure (acpr)**.
- 2 In the **Settings** window for **3D Plot Group**, type Acoustic Pressure (ta+acpr) in the **Label** text field.
- 3 Locate the **Selection** section. From the **Geometric entity level** list, choose **Domain**.
- 4 From the **Selection** list, choose **All except PML**.
- 5 Select the **Apply to dataset edges** check box.

Surface 1

- 1 In the **Model Builder** window, expand the **Acoustic Pressure (ta+acpr)** node.
- 2 Right-click **Surface 1** and choose **Delete**.

Volume 1

- 1 In the **Model Builder** window, right-click **Acoustic Pressure (ta+acpr)** and choose **Volume**.
- 2 In the **Settings** window for **Volume**, locate the **Expression** section.
- 3 In the **Expression** text field, type `if(isnan(acpr.p_t), ta.p_t, acpr.p_t)`.
- 4 Select the **Description** check box.
- 5 In the associated text field, type Acoustic pressure.

- 6 Locate the **Coloring and Style** section. From the **Color table** list, choose **Wave**.
- 7 Select the **Symmetrize color range** check box.

Filter 1

- 1 Right-click **Volume 1** and choose **Filter**.
- 2 In the **Settings** window for **Filter**, locate the **Element Selection** section.
- 3 In the **Logical expression for inclusion** text field, type $(x < y)$.
- 4 In the **Acoustic Pressure (ta+acpr)** toolbar, click  **Plot**.

The image should look like that in [Figure 4](#).

Acoustic Pressure, Isosurfaces (ta+acpr)

- 1 In the **Model Builder** window, under **Results** click **Acoustic Pressure, Isosurfaces (acpr)**.
- 2 In the **Settings** window for **3D Plot Group**, type **Acoustic Pressure, Isosurfaces (ta+acpr)** in the **Label** text field.
- 3 Locate the **Selection** section. From the **Geometric entity level** list, choose **Domain**.
- 4 From the **Selection** list, choose **All except PML**.
- 5 Select the **Apply to dataset edges** check box.

Isosurface 1

- 1 In the **Model Builder** window, expand the **Acoustic Pressure, Isosurfaces (ta+acpr)** node, then click **Isosurface 1**.
- 2 In the **Settings** window for **Isosurface**, locate the **Expression** section.
- 3 In the **Expression** text field, type $\text{if}(\text{isnan}(\text{acpr.p}_t), \text{ta.p}_t, \text{acpr.p}_t)$.
- 4 Select the **Description** check box.
- 5 In the associated text field, type **Acoustic pressure**.

- 6 In the **Acoustic Pressure, Isosurfaces (ta+acpr)** toolbar, click  **Plot**.
The image should look like this.

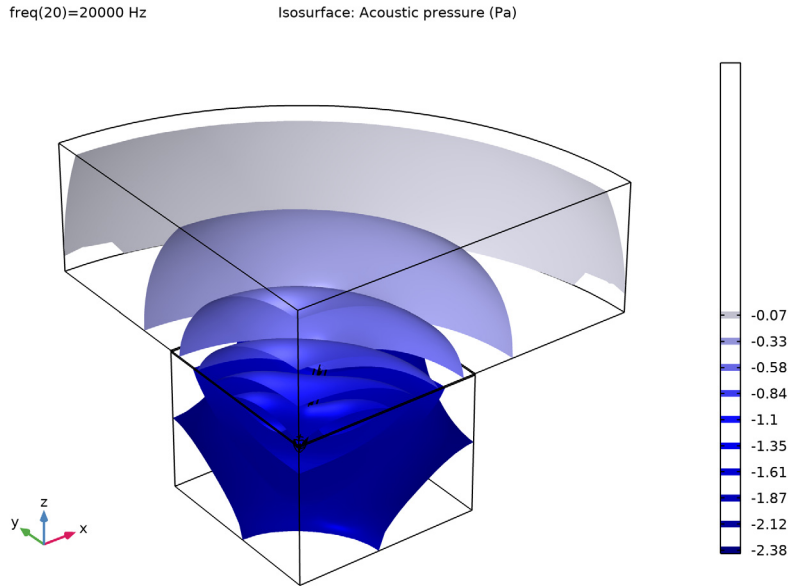

Acoustic Velocity (ta)

- 1 In the **Model Builder** window, click **Acoustic Velocity (ta)**.
- 2 In the **Settings** window for **3D Plot Group**, locate the **Data** section.
- 3 From the **Parameter value (freq (Hz))** list, choose **9000**.
- 4 Locate the **Selection** section. From the **Geometric entity level** list, choose **Domain**.
- 5 From the **Selection** list, choose **Thermoviscous Domains**.
- 6 Select the **Apply to dataset edges** check box.
- 7 Locate the **Plot Settings** section. Clear the **Plot dataset edges** check box.
- 8 In the **Acoustic Velocity (ta)** toolbar, click  **Plot**.

Slice

- 1 In the **Model Builder** window, expand the **Acoustic Velocity (ta)** node, then click **Slice**.
- 2 In the **Settings** window for **Slice**, locate the **Plane Data** section.
- 3 From the **Plane type** list, choose **General**.
- 4 From the **Plane entry method** list, choose **Point and normal vector**.

- 5 Find the **Point** subsection. In the **x** text field, type 20.
- 6 In the **y** text field, type 20.
- 7 Find the **Normal vector** subsection. In the **x** text field, type 1.
- 8 In the **y** text field, type 1.
- 9 In the **z** text field, type 0.
- 10 Select the **Additional parallel planes** check box.
- 11 In the **Planes** text field, type 10.
- 12 In the **Acoustic Velocity (ta)** toolbar, click  **Plot**.

The image should look like that in [Figure 5](#).

Temperature Variation (ta)

- 1 In the **Model Builder** window, click **Temperature Variation (ta)**.
- 2 In the **Settings** window for **3D Plot Group**, locate the **Data** section.
- 3 From the **Parameter value (freq (Hz))** list, choose **9000**.
- 4 Locate the **Selection** section. From the **Geometric entity level** list, choose **Domain**.
- 5 From the **Selection** list, choose **Thermoviscous Domains**.
- 6 Select the **Apply to dataset edges** check box.
- 7 Locate the **Plot Settings** section. Clear the **Plot dataset edges** check box.
- 8 In the **Temperature Variation (ta)** toolbar, click  **Plot**.

Multislice

- 1 In the **Model Builder** window, expand the **Temperature Variation (ta)** node.
- 2 Right-click **Multislice** and choose **Delete**.

Slice 1

- 1 In the **Model Builder** window, right-click **Temperature Variation (ta)** and choose **Slice**.
- 2 In the **Settings** window for **Slice**, locate the **Expression** section.
- 3 In the **Expression** text field, type $ta.T_t$.
- 4 Locate the **Plane Data** section. From the **Plane type** list, choose **General**.
- 5 From the **Plane entry method** list, choose **Point and normal vector**.
- 6 Find the **Point** subsection. In the **x** text field, type 20.
- 7 In the **y** text field, type 20.
- 8 Find the **Normal vector** subsection. In the **x** text field, type 1.
- 9 In the **y** text field, type 1.

- 10 In the **z** text field, type 0.
 - 11 Select the **Additional parallel planes** check box.
 - 12 In the **Planes** text field, type 10.
 - 13 Locate the **Coloring and Style** section. From the **Color table** list, choose **ThermalEquidistant**.
 - 14 Select the **Symmetrize color range** check box.
 - 15 In the **Temperature Variation (ta)** toolbar, click  **Plot**.
- The image should look like this.

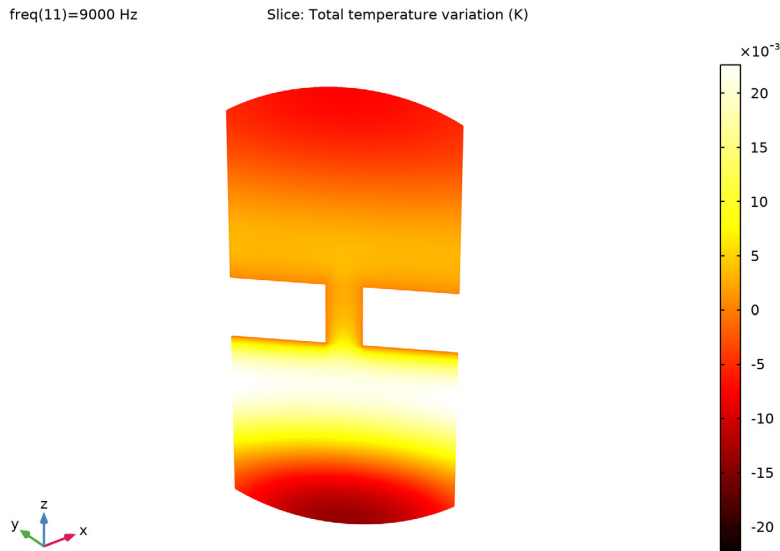

Logarithmic Thermoviscous Losses (ta)

- 1 Right-click **Temperature Variation (ta)** and choose **Duplicate**.
- 2 In the **Settings** window for **3D Plot Group**, type Logarithmic Thermoviscous Losses (ta) in the **Label** text field.

Slice 1

- 1 In the **Model Builder** window, expand the **Logarithmic Thermoviscous Losses (ta)** node, then click **Slice 1**.
- 2 In the **Settings** window for **Slice**, locate the **Expression** section.
- 3 In the **Expression** text field, type $\log_{10}(ta.diss_{tot})$.

- 4 Select the **Description** check box.
- 5 In the associated text field, type $\log_{10}(\text{Thermoviscous losses})$.
- 6 Click to expand the **Range** section. Select the **Manual color range** check box.
- 7 In the **Minimum** text field, type 6.1.
- 8 In the **Maximum** text field, type 8.1.
- 9 Locate the **Coloring and Style** section. From the **Color table** list, choose **HeatCameraLight**.
- 10 Clear the **Symmetrize color range** check box.

The image should look like that in [Figure 6](#).

Pressure Acoustics Results

- 1 In the **Results** toolbar, click  **Table**.
To compare the current results with a pure Pressure Acoustics model and a Pressure Acoustics narrow region acoustics model, import two tables generated using these approaches.
- 2 In the **Settings** window for **Table**, type Pressure Acoustics Results in the **Label** text field.
- 3 Locate the **Data** section. Click **Import**.
- 4 Browse to the model's Application Libraries folder and double-click the file `piezo_mems_speaker_pa.csv`.

Pressure Acoustics With Narrow Region Acoustics Results

- 1 In the **Results** toolbar, click  **Table**.
- 2 In the **Settings** window for **Table**, type Pressure Acoustics With Narrow Region Acoustics Results in the **Label** text field.
- 3 Locate the **Data** section. Click **Import**.
- 4 Browse to the model's Application Libraries folder and double-click the file `piezo_mems_speaker_pa_narrow_region.csv`.

Terminal Impedance

- 1 In the **Results** toolbar, click  **ID Plot Group**.
- 2 In the **Settings** window for **ID Plot Group**, type Terminal Impedance in the **Label** text field.
- 3 Locate the **Plot Settings** section. Select the **Two y-axes** check box.
- 4 Locate the **Axis** section. Select the **Manual axis limits** check box.
- 5 In the **x minimum** text field, type 18.

- 6 In the **x maximum** text field, type 20000.
- 7 In the **y minimum** text field, type 0.1.
- 8 In the **y maximum** text field, type 150.
- 9 In the **Secondary y minimum** text field, type -91.
- 10 In the **Secondary y maximum** text field, type -20.
- 11 Select the **x-axis log scale** check box.
- 12 Select the **y-axis log scale** check box.
- 13 Locate the **Legend** section. From the **Position** list, choose **Lower left**.

Global 1

- 1 Right-click **Terminal Impedance** and choose **Global**.
- 2 In the **Settings** window for **Global**, locate the **y-Axis Data** section.
- 3 In the table, enter the following settings:

Expression	Unit	Description
$\text{abs}(1/\text{es.Y11})/4$	$\text{k}\Omega$	Impedance

- 4 In the **Terminal Impedance** toolbar, click  **Plot**.

Global 2

- 1 In the **Model Builder** window, right-click **Terminal Impedance** and choose **Global**.
- 2 In the **Settings** window for **Global**, locate the **y-Axis** section.
- 3 Select the **Plot on secondary y-axis** check box.
- 4 Locate the **y-Axis Data** section. In the table, enter the following settings:

Expression	Unit	Description
$\text{arg}((1/\text{es.Y11}))$	deg	Angle

- 5 In the **Terminal Impedance** toolbar, click  **Plot**.

Table Graph 1

- 1 Right-click **Terminal Impedance** and choose **Table Graph**.
- 2 In the **Settings** window for **Table Graph**, locate the **Data** section.
- 3 From the **x-axis data** list, choose **freq (Hz)**.
- 4 From the **Plot columns** list, choose **Manual**.
- 5 In the **Columns** list, select **$\text{abs}(1/\text{es.Y11})/4$ (Ω)**.

- 6 Locate the **Coloring and Style** section. Find the **Line style** subsection. From the **Line** list, choose **Dotted**.
- 7 From the **Color** list, choose **Cycle (reset)**.
- 8 Click to expand the **Preprocessing** section. Find the **y-axis columns** subsection. From the **Preprocessing** list, choose **Linear**.
- 9 In the **Scaling** text field, type 1/1000.
- 10 Click to expand the **Legends** section. Select the **Show legends** check box.
- 11 From the **Legends** list, choose **Manual**.
- 12 In the table, enter the following settings:

Legends
Impedance - Lossless

- 13 In the **Terminal Impedance** toolbar, click  **Plot**.

Table Graph 2

- 1 Right-click **Terminal Impedance** and choose **Table Graph**.
- 2 In the **Settings** window for **Table Graph**, locate the **Data** section.
- 3 From the **x-axis data** list, choose **freq (Hz)**.
- 4 From the **Plot columns** list, choose **Manual**.
- 5 In the **Columns** list, select **arg((1/es.YI I)) (rad)**.
- 6 Locate the **y-Axis** section. Select the **Plot on secondary y-axis** check box.
- 7 Locate the **Preprocessing** section. Find the **y-axis columns** subsection. From the **Preprocessing** list, choose **Linear**.
- 8 In the **Scaling** text field, type 180/pi.
- 9 Locate the **Coloring and Style** section. Find the **Line style** subsection. From the **Line** list, choose **Dotted**.
- 10 Locate the **Legends** section. Select the **Show legends** check box.
- 11 From the **Legends** list, choose **Manual**.
- 12 In the table, enter the following settings:

Legends
Angle - Lossless

- 13 In the **Terminal Impedance** toolbar, click  **Plot**.

Table Graph 3

- 1 Right-click **Terminal Impedance** and choose **Table Graph**.
- 2 In the **Settings** window for **Table Graph**, locate the **Data** section.
- 3 From the **Table** list, choose **Pressure Acoustics With Narrow Region Acoustics Results**.
- 4 From the **x-axis data** list, choose **freq (Hz)**.
- 5 From the **Plot columns** list, choose **Manual**.
- 6 In the **Columns** list, select **$\text{abs}(1/\text{es.Y11})/4$ (Ω)**.
- 7 Locate the **Preprocessing** section. Find the **y-axis columns** subsection. From the **Preprocessing** list, choose **Linear**.
- 8 In the **Scaling** text field, type 1/1000.
- 9 Locate the **Coloring and Style** section. Find the **Line style** subsection. From the **Line** list, choose **Dashed**.
- 10 From the **Color** list, choose **Cycle (reset)**.
- 11 Locate the **Legends** section. Select the **Show legends** check box.
- 12 From the **Legends** list, choose **Manual**.
- 13 In the table, enter the following settings:

Legends

Impedance - Narrow Region

- 14 In the **Terminal Impedance** toolbar, click  **Plot**.

Table Graph 4

- 1 Right-click **Terminal Impedance** and choose **Table Graph**.
- 2 In the **Settings** window for **Table Graph**, locate the **Data** section.
- 3 From the **Table** list, choose **Pressure Acoustics With Narrow Region Acoustics Results**.
- 4 From the **x-axis data** list, choose **freq (Hz)**.
- 5 From the **Plot columns** list, choose **Manual**.
- 6 In the **Columns** list, select **$\text{arg}(1/\text{es.Y11})$ (rad)**.
- 7 Locate the **y-Axis** section. Select the **Plot on secondary y-axis** check box.
- 8 Locate the **Preprocessing** section. Find the **y-axis columns** subsection. From the **Preprocessing** list, choose **Linear**.
- 9 In the **Scaling** text field, type $180/\pi$.
- 10 Locate the **Coloring and Style** section. Find the **Line style** subsection. From the **Line** list, choose **Dashed**.

11 Locate the **Legends** section. Select the **Show legends** check box.

12 From the **Legends** list, choose **Manual**.

13 In the table, enter the following settings:

Legends

Angle - Narrow Region

14 In the **Terminal Impedance** toolbar, click  **Plot**.

The image should look like that in [Figure 7](#).

Study 1/Solution 1 (3) (sol1)

In the **Results** toolbar, click  **More Datasets** and choose **Solution**.

Selection

1 In the **Results** toolbar, click  **Attributes** and choose **Selection**.

2 In the **Settings** window for **Selection**, locate the **Geometric Entity Selection** section.

3 From the **Geometric entity level** list, choose **Domain**.

4 From the **Selection** list, choose **Electrostatics Domains**.

Sector 3D 1

1 In the **Results** toolbar, click  **More Datasets** and choose **Sector 3D**.

2 In the **Settings** window for **Sector 3D**, locate the **Data** section.

3 From the **Dataset** list, choose **Study 1/Solution 1 (3) (sol1)**.

4 Locate the **Symmetry** section. In the **Number of sectors** text field, type 4.

5 From the **Transformation** list, choose **Rotation and reflection**.

Model Thumbnail

1 In the **Results** toolbar, click  **3D Plot Group**.

2 In the **Settings** window for **3D Plot Group**, type Model Thumbnail in the **Label** text field.

3 Locate the **Data** section. From the **Dataset** list, choose **Sector 3D 1**.

4 From the **Parameter value (freq (Hz))** list, choose **9000**.

5 Locate the **Plot Settings** section. Clear the **Plot dataset edges** check box.

6 In the **Model Thumbnail** toolbar, click  **Plot**.



7 Click the  **Show Grid** button in the **Graphics** toolbar.

8 Click the  **Zoom Extents** button in the **Graphics** toolbar.

Volume 1

Right-click **Model Thumbnail** and choose **Volume**.

Deformation 1

- 1 In the **Model Builder** window, right-click **Volume 1** and choose **Deformation**.
- 2 In the **Settings** window for **Deformation**, locate the **Scale** section.
- 3 Select the **Scale factor** check box.
- 4 In the associated text field, type 100.
- 5 In the **Model Thumbnail** toolbar, click  **Plot**.
- 6 Click  **Plot**.

Slice 1



- 1 In the **Model Builder** window, right-click **Model Thumbnail** and choose **Slice**.
- 2 In the **Settings** window for **Slice**, locate the **Expression** section.
- 3 In the **Expression** text field, type `ta.v_inst`.
- 4 Locate the **Plane Data** section. From the **Plane type** list, choose **General**.
- 5 From the **Plane entry method** list, choose **Point and normal vector**.
- 6 Find the **Normal vector** subsection. In the **x** text field, type 1.
- 7 In the **y** text field, type 1.
- 8 In the **z** text field, type 0.
- 9 Select the **Additional parallel planes** check box.
- 10 In the **Planes** text field, type 20.
- 11 Locate the **Coloring and Style** section. Clear the **Color legend** check box.
- 12 From the **Color table** list, choose **Traffic**.
- 13 Click to expand the **Inherit Style** section. From the **Plot** list, choose **Volume 1**.
- 14 Clear the **Color** check box.
- 15 Clear the **Color and data range** check box.
- 16 In the **Model Thumbnail** toolbar, click  **Plot**.

Deformation 1

- 1 Right-click **Slice 1** and choose **Deformation**.
- 2 In the **Settings** window for **Deformation**, locate the **Expression** section.
- 3 In the **x component** text field, type 0.
- 4 In the **y component** text field, type 0.

5 In the **z component** text field, type `linext1(w)`.

Slice 2

- 1 In the **Model Builder** window, under **Results>Model Thumbnail** right-click **Slice 1** and choose **Duplicate**.
- 2 In the **Settings** window for **Slice**, locate the **Plane Data** section.
- 3 Find the **Normal vector** subsection. In the **x** text field, type `-1`.
- 4 Click to expand the **Title** section. From the **Title type** list, choose **None**.
- 5 In the **Model Thumbnail** toolbar, click  **Plot**.
- 6 Click the  **Go to Default View** button in the **Graphics** toolbar.

Line 1

- 1 In the **Model Builder** window, right-click **Model Thumbnail** and choose **Line**.
- 2 In the **Settings** window for **Line**, locate the **Expression** section.
- 3 In the **Expression** text field, type `0`.
- 4 Click to expand the **Title** section. From the **Title type** list, choose **None**.
- 5 Locate the **Coloring and Style** section. From the **Coloring** list, choose **Uniform**.
- 6 From the **Color** list, choose **Black**.
- 7 Click to expand the **Inherit Style** section. From the **Plot** list, choose **Volume 1**.
- 8 Clear the **Color** check box.
- 9 Clear the **Color and data range** check box.

Deformation 1

Right-click **Line 1** and choose **Deformation**.

Model Thumbnail

1 In the **Model Thumbnail** toolbar, click  **Plot**.

The image should look like this.

freq(11)=9000 Hz Volume: Displacement magnitude (μm) Slice: Instantaneous local velocity (m/s)

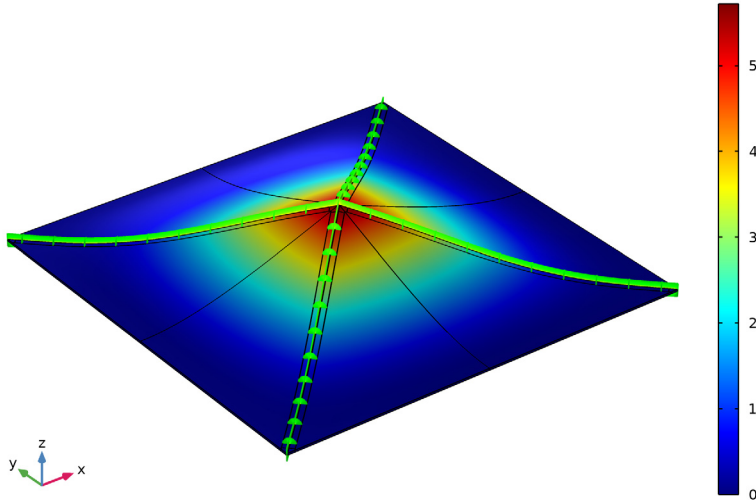

Appendix: Geometry Sequence Instructions

From the **File** menu, choose **New**.

NEW

In the **New** window, click  **Model Wizard**.

MODEL WIZARD

1 In the **Model Wizard** window, click  **3D**.

2 Click **Done**.

GEOMETRY I

Adjust the units of the model to μm .

1 In the **Model Builder** window, under **Component 1 (comp1)** click **Geometry 1**.

2 In the **Settings** window for **Geometry**, locate the **Units** section.

3 From the **Length unit** list, choose **µm**.

Import the parameters from an external file. This file contains parameters like dimensions, maximum frequency and voltage that define the current model.

GLOBAL DEFINITIONS

Parameters 1

1 In the **Model Builder** window, under **Global Definitions** click **Parameters 1**.

2 In the **Settings** window for **Parameters**, locate the **Parameters** section.

3 In the table, enter the following settings:

Name	Expression	Value	Description
l_speaker	4[mm]	0.004 m	Side of the speaker
th_si	15[um]	1.5E-5 m	Thickness of the silicon layer
th_pzt	2[um]	2E-6 m	Thickness of the PZT layer
air_gap	9[um]	9E-6 m	Air gap between the actuators
d_speaker	1.5[mm]	0.0015 m	Back cavity depth

Create a **Work Plane** where the main features of the speaker will be defined. The model uses symmetry to only model one fourth of the geometry. This reduces the computation time.

GEOMETRY 1

Click the  **Show Grid** button in the **Graphics** toolbar.

Work Plane 1 (wp1)

In the **Geometry** toolbar, click  **Work Plane**.

Work Plane 1 (wp1)>Plane Geometry

In the **Model Builder** window, click **Plane Geometry**.

Work Plane 1 (wp1)>Square 1 (sq1)

1 In the **Work Plane** toolbar, click  **Square**.

2 In the **Settings** window for **Square**, locate the **Size** section.

3 In the **Side length** text field, type $l_speaker/2$.

4 Click  **Build Selected**.

5 Click the  **Zoom Extents** button in the **Graphics** toolbar.

Work Plane 1 (wp1)>Rectangle 1 (r1)

1 In the **Work Plane** toolbar, click  **Rectangle**.

Create a rectangle that represents the air gap in the membrane. This gap will be modeled using Thermoviscous Acoustics.

2 In the **Settings** window for **Rectangle**, locate the **Size and Shape** section.

3 In the **Width** text field, type $\sqrt{2}/2*1_speaker-air_gap$.

4 In the **Height** text field, type $12*air_gap$.

5 Locate the **Position** section. From the **Base** list, choose **Center**.

6 In the **xw** text field, type $1_speaker/4$.

7 In the **yw** text field, type $1_speaker/4$.

8 Locate the **Rotation Angle** section. In the **Rotation** text field, type 45.

9 Click to expand the **Layers** section. In the table, enter the following settings:

Layer name	Thickness (μm)
Layer 1	$5.5*air_gap$

10 Select the **Layers on top** check box.

11 Click  **Build Selected**.

Create a new rectangle so that a swept mesh can be generated in the Thermoviscous Acoustics domains.

Work Plane 1 (wp1)>Rectangle 2 (r2)

1 In the **Work Plane** toolbar, click  **Rectangle**.

2 In the **Settings** window for **Rectangle**, locate the **Size and Shape** section.

3 In the **Width** text field, type $\sqrt{2}/2*1_speaker-16*air_gap$.

4 In the **Height** text field, type $12*air_gap$.

5 Locate the **Position** section. From the **Base** list, choose **Center**.

6 In the **xw** text field, type $1_speaker/4$.

7 In the **yw** text field, type $1_speaker/4$.

8 Locate the **Rotation Angle** section. In the **Rotation** text field, type 45.

Work Plane 1 (wp1)>Union 1 (uni1)

1 In the **Work Plane** toolbar, click  **Booleans and Partitions** and choose **Union**.

2 Click in the **Graphics** window and then press Ctrl+A to select all objects.

3 In the **Settings** window for **Union**, click  **Build Selected**.

Work Plane 1 (wp1)>Delete Entities 1 (del1)

- 1 Right-click **Plane Geometry** and choose **Delete Entities**.
- 2 In the **Settings** window for **Delete Entities**, locate the **Entities or Objects to Delete** section.
- 3 From the **Geometric entity level** list, choose **Domain**.
- 4 On the object **unil**, select Domains 1, 6, 13, and 17 only.
- 5 Click  **Build Selected**.

Extrude the **Work Plane 1** to create the 3D geometry that represents the silicon and the PZT Layers of the membrane.

Extrude 1 (ext1)

- 1 In the **Model Builder** window, under **Component 1 (comp1)>Geometry 1** right-click **Work Plane 1 (wp1)** and choose **Extrude**.
- 2 In the **Settings** window for **Extrude**, locate the **Distances** section.
- 3 In the table, enter the following settings:

Distances (μm)
th_si
th_si+th_pzt

- 4 Select the **Reverse direction** check box.

5 Click  **Build Selected**.

The geometry should look like this.

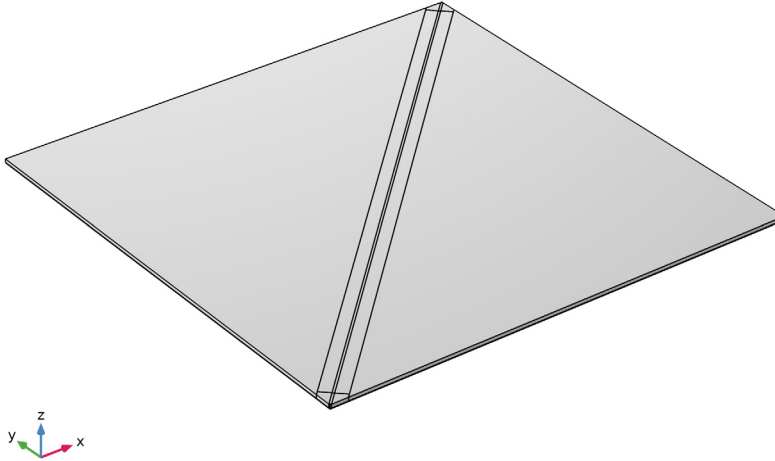

Add a cylinder that will be used for the Thermoviscous Acoustics domains.

Cylinder 1 (cyl1)

- 1 In the **Geometry** toolbar, click  **Cylinder**.
- 2 In the **Settings** window for **Cylinder**, locate the **Size and Shape** section.
- 3 In the **Radius** text field, type $6 \cdot \text{air_gap}$.
- 4 In the **Height** text field, type $\sqrt{2} / 2 \cdot 1_speaker$.
- 5 Locate the **Axis** section. From the **Axis type** list, choose **Cartesian**.
- 6 In the **x** text field, type 1.
- 7 In the **y** text field, type 1.
- 8 In the **z** text field, type 0.
- 9 Click to expand the **Layers** section. In the table, enter the following settings:

Layer name	Thickness (μm)
Layer 1	$8 \cdot \text{air_gap}$

- 10 Clear the **Layers on side** check box.

11 Select the **Layers on bottom** check box.

12 Select the **Layers on top** check box.

13 Click  **Build Selected**.

Split the cylinder in two halves and move them to the right location in the following steps.

Partition Objects 1 (par1)

1 In the **Geometry** toolbar, click  **Booleans and Partitions** and choose **Partition Objects**.

2 Select the object **cyl1** only.

3 In the **Settings** window for **Partition Objects**, locate the **Partition Objects** section.

4 From the **Partition with** list, choose **Work plane**.

5 Click  **Build Selected**.

Move 1 (mov1)

1 In the **Geometry** toolbar, click  **Transforms** and choose **Move**.

2 Select the object **par1** only.

3 In the **Settings** window for **Move**, locate the **Displacement** section.

4 In the **z** text field, type `-th_pzt - th_si`.

5 Locate the **Input** section. Select the **Keep input objects** check box.

6 Click  **Build Selected**.

Delete Entities 1 (del1)

1 In the **Model Builder** window, right-click **Geometry 1** and choose **Delete Entities**.

2 In the **Settings** window for **Delete Entities**, locate the **Entities or Objects to Delete** section.

3 From the **Geometric entity level** list, choose **Domain**.

4 On the object **mov1**, select Domains 2, 4, and 6 only.

5 On the object **par1**, select Domains 1, 3, and 5 only.

6 Click  **Build Selected**.

Add a cylinder that represents an infinite domain in front of the speaker.

Cylinder 2 (cyl2)

1 In the **Geometry** toolbar, click  **Cylinder**.



2 In the **Settings** window for **Cylinder**, locate the **Size and Shape** section.

3 In the **Radius** text field, type `1.2*1_speaker`.



4 In the **Height** text field, type `1.2*1_speaker`.

- 5 Locate the **Position** section. In the **z** text field, type $-0.6 \cdot l_{\text{speaker}}$.
- 6 Locate the **Layers** section. In the table, enter the following settings:

Layer name	Thickness (μm)
Layer 1	$l_{\text{speaker}}/4$

- 7 Select the **Layers on bottom** check box.
- 8 Select the **Layers on top** check box.
- 9 Click  **Build Selected**.
- 10 Click the  **Wireframe Rendering** button in the **Graphics** toolbar.
Wireframe Rendering simplifies the selection of boundaries in the geometry.



Partition Objects 2 (par2)

- 1 In the **Geometry** toolbar, click  **Booleans and Partitions** and choose **Partition Objects**.
- 2 Select the object **cyl2** only.
- 3 In the **Settings** window for **Partition Objects**, locate the **Partition Objects** section.
- 4 From the **Partition with** list, choose **Work plane**.
- 5 Click  **Build Selected**.

Delete Entities 2 (del2)

- 1 Right-click **Geometry 1** and choose **Delete Entities**.
- 2 In the **Settings** window for **Delete Entities**, locate the **Entities or Objects to Delete** section.
- 3 From the **Geometric entity level** list, choose **Domain**.
- 4 On the object **par2**, select Domains 1–4, 9, 10, 13, 14, 17, and 18 only.
- 5 Click  **Build Selected**.

Block 1 (blk1)

- 1 In the **Geometry** toolbar, click  **Block**.
This block represents the back volume of the speaker.
- 2 In the **Settings** window for **Block**, locate the **Size and Shape** section.
- 3 In the **Width** text field, type $l_{\text{speaker}}/2$.
- 4 In the **Depth** text field, type $l_{\text{speaker}}/2$.
- 5 In the **Height** text field, type d_{speaker} .
- 6 Locate the **Position** section. In the **z** text field, type $-th_{\text{si}} - th_{\text{pzt}} - d_{\text{speaker}}$.
- 7 Click  **Build Selected**.

Work Plane 2 (wp2)

1 In the **Geometry** toolbar, click  **Work Plane**.

This is the first symmetry plane.

2 In the **Settings** window for **Work Plane**, locate the **Plane Definition** section.

3 From the **Plane** list, choose **yz-plane**.

Work Plane 3 (wp3)

1 In the **Geometry** toolbar, click  **Work Plane**.

This is the second symmetry plane.

2 In the **Settings** window for **Work Plane**, locate the **Plane Definition** section.

3 From the **Plane** list, choose **zx-plane**.

Union 1 (uni1)

1 In the **Geometry** toolbar, click  **Booleans and Partitions** and choose **Union**.

2 Select the object **del2** only.

3 Click in the **Graphics** window and then press Ctrl+A to select all objects.

4 In the **Settings** window for **Union**, click  **Build Selected**.

Partition Objects 3 (par3)

1 In the **Geometry** toolbar, click  **Booleans and Partitions** and choose **Partition Objects**.

2 Select the object **uni1** only.

3 In the **Settings** window for **Partition Objects**, locate the **Partition Objects** section.

4 From the **Partition with** list, choose **Work plane**.

5 From the **Work plane** list, choose **Work Plane 2 (wp2)**.

6 Click  **Build Selected**.

Partition Objects 4 (par4)

1 In the **Geometry** toolbar, click  **Booleans and Partitions** and choose **Partition Objects**.

2 Select the object **par3** only.

3 In the **Settings** window for **Partition Objects**, locate the **Partition Objects** section.



4 From the **Partition with** list, choose **Work plane**.

5 Click  **Build Selected**.

Delete Entities 3 (del3)

1 Right-click **Geometry 1** and choose **Delete Entities**.

Delete the domains outside of the first quadrant xy-plane.

- 2 In the **Settings** window for **Delete Entities**, locate the **Entities or Objects to Delete** section.
- 3 From the **Geometric entity level** list, choose **Domain**.
- 4 On the object **par4**, select Domains 1–14, 17, 21, 48, and 55 only.
- 5 Click  **Build Selected**.
- 6 Click the  **Zoom Extents** button in the **Graphics** toolbar.
The geometry should look like this.

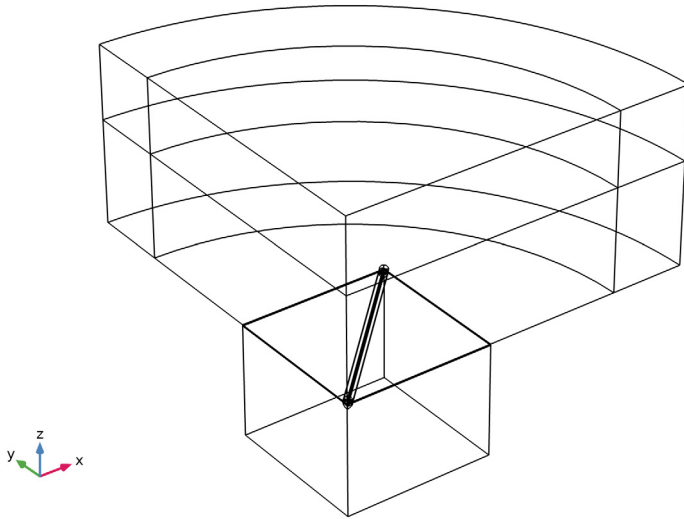

Thermoviscous Domain 1



- 1 In the **Geometry** toolbar, click  **Selections** and choose **Cylinder Selection**.
This selection includes the domains that will be represented using the **Thermoviscous Acoustics, Frequency Domain** interface.
- 2 In the **Settings** window for **Cylinder Selection**, type Thermoviscous Domain 1 in the **Label** text field.
- 3 Locate the **Size and Shape** section. In the **Outer radius** text field, type $6 \cdot \text{air_gap}$.
- 4 Locate the **Axis** section. From the **Axis type** list, choose **Cartesian**.
- 5 In the **x** text field, type 1.
- 6 In the **y** text field, type 1.
- 7 In the **z** text field, type 0.

- 8 Locate the **Output Entities** section. From the **Include entity if** list, choose **All vertices inside cylinder**.

Thermoviscous Domain 2

- 1 Right-click **Thermoviscous Domain 1** and choose **Duplicate**.
- 2 In the **Settings** window for **Cylinder Selection**, type **Thermoviscous Domain 2** in the **Label** text field.
- 3 Locate the **Position** section. In the **z** text field, type **-th_si-th_pzt**.
- 4 Click  **Build Selected**.

Thermoviscous Domains

- 1 In the **Geometry** toolbar, click  **Selections** and choose **Union Selection**.
- 2 In the **Settings** window for **Union Selection**, type **Thermoviscous Domains** in the **Label** text field.
- 3 Locate the **Input Entities** section. Click  **Add**.
- 4 In the **Add** dialog box, in the **Selections to add** list, choose **Thermoviscous Domain 1** and **Thermoviscous Domain 2**.
- 5 Click **OK**.
- 6 In the **Settings** window for **Union Selection**, locate the **Color** section.
- 7 From the **Color** list, choose **Color 5**.

Silicon Layer With Air





- 1 In the **Geometry** toolbar, click  **Selections** and choose **Box Selection**.
- 2 In the **Settings** window for **Box Selection**, type **Silicon Layer With Air** in the **Label** text field.
- 3 Locate the **Box Limits** section. In the **z minimum** text field, type **-th_si**.
- 4 In the **z maximum** text field, type **0**.
- 5 Locate the **Output Entities** section. From the **Include entity if** list, choose **Entity inside box**.

PZT Layer With Air



- 1 In the **Geometry** toolbar, click  **Selections** and choose **Box Selection**.
- 2 In the **Settings** window for **Box Selection**, type **PZT Layer With Air** in the **Label** text field.
- 3 Locate the **Box Limits** section. In the **z minimum** text field, type **-th_si-th_pzt**.
- 4 In the **z maximum** text field, type **-th_si**.

- 5 Locate the **Output Entities** section. From the **Include entity if** list, choose **Entity inside box**.

Silicon Domains

- 1 In the **Geometry** toolbar, click  **Selections** and choose **Difference Selection**.
- 2 In the **Settings** window for **Difference Selection**, type Silicon Domains in the **Label** text field.
- 3 Locate the **Input Entities** section. Click  **Add**.
- 4 In the **Add** dialog box, select **Silicon Layer With Air** in the **Selections to add** list.
- 5 Click **OK**.
- 6 In the **Settings** window for **Difference Selection**, locate the **Input Entities** section.
- 7 Click  **Add**.
- 8 In the **Add** dialog box, select **Thermoviscous Domains** in the **Selections to subtract** list.
- 9 Click **OK**.
- 10 In the **Settings** window for **Difference Selection**, locate the **Color** section.
- 11 From the **Color** list, choose **Color 8**.
- 12 Click  **Build Selected**.

PZT Domains



- 1 In the **Geometry** toolbar, click  **Selections** and choose **Difference Selection**.
- 2 In the **Settings** window for **Difference Selection**, type PZT Domains in the **Label** text field.
- 3 Locate the **Input Entities** section. Click  **Add**.
- 4 In the **Add** dialog box, select **PZT Layer With Air** in the **Selections to add** list.
- 5 Click **OK**.
- 6 In the **Settings** window for **Difference Selection**, locate the **Input Entities** section.
- 7 Click  **Add**.
- 8 In the **Add** dialog box, select **Thermoviscous Domains** in the **Selections to subtract** list.
- 9 Click **OK**.
- 10 In the **Settings** window for **Difference Selection**, locate the **Color** section.
- 11 From the **Color** list, choose **Color 12**.

Structural Domains



- 1 In the **Geometry** toolbar, click  **Selections** and choose **Union Selection**.
- 2 In the **Settings** window for **Union Selection**, type Structural Domains in the **Label** text field.

- 3 Locate the **Input Entities** section. Click  **Add**.
- 4 In the **Add** dialog box, in the **Selections to add** list, choose **Silicon Domains** and **PZT Domains**.
- 5 Click **OK**.





All Domains

- 1 In the **Geometry** toolbar, click  **Selections** and choose **Ball Selection**.
- 2 In the **Settings** window for **Ball Selection**, type All Domains in the **Label** text field.
- 3 Locate the **Ball Radius** section. In the **Radius** text field, type $2*1_speaker$.
- 4 Click  **Build Selected**.

Inner Domains



- 1 In the **Geometry** toolbar, click  **Selections** and choose **Cylinder Selection**.
- 2 In the **Settings** window for **Cylinder Selection**, type Inner Domains in the **Label** text field.
- 3 Locate the **Size and Shape** section. In the **Outer radius** text field, type $0.8*1_speaker$.
- 4 In the **Top distance** text field, type $0.3*1_speaker$.
- 5 Click  **Build Selected**.

PML Domains



- 1 In the **Geometry** toolbar, click  **Selections** and choose **Difference Selection**.
- 2 In the **Settings** window for **Difference Selection**, type PML Domains in the **Label** text field.
- 3 Locate the **Input Entities** section. Click  **Add**.
- 4 In the **Add** dialog box, select **All Domains** in the **Selections to add** list.
- 5 Click **OK**.
- 6 In the **Settings** window for **Difference Selection**, locate the **Input Entities** section.
- 7 Click  **Add**.
- 8 In the **Add** dialog box, select **Inner Domains** in the **Selections to subtract** list.
- 9 Click **OK**.
- 10 In the **Settings** window for **Difference Selection**, click  **Build Selected**.
- 11 Click  **Build Selected**.

Pressure Acoustics Domains



- 1 In the **Geometry** toolbar, click  **Selections** and choose **Difference Selection**.
- 2 In the **Settings** window for **Difference Selection**, type Pressure Acoustics Domains in the **Label** text field.

- 3 Locate the **Input Entities** section. Click  **Add**.
- 4 In the **Add** dialog box, select **All Domains** in the **Selections to add** list.
- 5 Click **OK**.
- 6 In the **Settings** window for **Difference Selection**, locate the **Input Entities** section.
- 7 Click  **Add**.
- 8 In the **Add** dialog box, in the **Selections to subtract** list, choose **Thermoviscous Domains** and **Structural Domains**.
- 9 Click **OK**.
- 10 In the **Settings** window for **Difference Selection**, locate the **Color** section.
- 11 From the **Color** list, choose **Color 10**.
- 12 Click  **Build Selected**.

Electrostatics Domains

- 1 In the **Geometry** toolbar, click  **Selections** and choose **Union Selection**.
- 2 In the **Settings** window for **Union Selection**, type Electrostatics Domains in the **Label** text field.
- 3 Locate the **Input Entities** section. Click  **Add**.
- 4 In the **Add** dialog box, in the **Selections to add** list, choose **Thermoviscous Domains** and **Structural Domains**.
- 5 Click **OK**.

Air Domains

- 1 In the **Geometry** toolbar, click  **Selections** and choose **Union Selection**.
- 2 In the **Settings** window for **Union Selection**, type Air Domains in the **Label** text field.
- 3 Locate the **Input Entities** section. Click  **Add**.
- 4 In the **Add** dialog box, in the **Selections to add** list, choose **Thermoviscous Domains** and **Pressure Acoustics Domains**.
- 5 Click **OK**.

All Boundaries

- 1 In the **Geometry** toolbar, click  **Selections** and choose **Box Selection**.
- 2 In the **Settings** window for **Box Selection**, type All Boundaries in the **Label** text field.
- 3 Locate the **Geometric Entity Level** section. From the **Level** list, choose **Boundary**.

Non Symmetric Boundaries

- 1 In the **Geometry** toolbar, click  **Selections** and choose **Box Selection**.

- 2 In the **Settings** window for **Box Selection**, type Non Symmetric Boundaries in the **Label** text field.
- 3 Locate the **Geometric Entity Level** section. From the **Level** list, choose **Boundary**.
- 4 Locate the **Box Limits** section. In the **x minimum** text field, type 0.01.
- 5 In the **y minimum** text field, type 0.01.

Symmetric Boundaries

- 1 In the **Geometry** toolbar, click  **Selections** and choose **Difference Selection**.
- 2 In the **Settings** window for **Difference Selection**, type Symmetric Boundaries in the **Label** text field.
- 3 Locate the **Geometric Entity Level** section. From the **Level** list, choose **Boundary**.
- 4 Locate the **Input Entities** section. Click **+ Add**.
- 5 In the **Add** dialog box, select **All Boundaries** in the **Selections to add** list.
- 6 Click **OK**.
- 7 In the **Settings** window for **Difference Selection**, locate the **Input Entities** section.
- 8 Click **+ Add**.
- 9 In the **Add** dialog box, select **Non Symmetric Boundaries** in the **Selections to subtract** list.
- 10 Click **OK**.

Exterior Field Boundaries

- 1 In the **Geometry** toolbar, click  **Selections** and choose **Explicit Selection**.
- 2 In the **Settings** window for **Explicit Selection**, type Exterior Field Boundaries in the **Label** text field.
- 3 Locate the **Entities to Select** section. From the **Geometric entity level** list, choose **Boundary**.
- 4 On the object **del3**, select Boundaries 23 and 49 only.

Ground



- 1 In the **Geometry** toolbar, click  **Selections** and choose **Explicit Selection**.
- 2 In the **Settings** window for **Explicit Selection**, type Ground in the **Label** text field.
- 3 Locate the **Entities to Select** section. From the **Geometric entity level** list, choose **Boundary**.
- 4 On the object **del3**, select Boundaries 33, 42, 62, 71, 89, 96, 107, and 129 only.

Terminal

- 1 In the **Geometry** toolbar, click  **Selections** and choose **Explicit Selection**.

- 2 In the **Settings** window for **Explicit Selection**, type Terminal in the **Label** text field.
- 3 Locate the **Entities to Select** section. From the **Geometric entity level** list, choose **Boundary**.
- 4 On the object **del3**, select Boundaries 28, 39, 59, 67, 86, 93, 102, and 126 only.

All except PML

- 1 In the **Geometry** toolbar, click  **Selections** and choose **Complement Selection**.
- 2 In the **Settings** window for **Complement Selection**, type All except PML in the **Label** text field.
- 3 Locate the **Input Entities** section. Click  **Add**.
- 4 In the **Add** dialog box, select **PML Domains** in the **Selections to invert** list.
- 5 Click **OK**.