



# Loudspeaker Spider Optimization

## *Introduction*

---

The suspension of a loudspeaker is designed to keep the cone and dust cap in place and avoid any rocking movement of the voice coil. At low frequencies, where the displacement of the cone and dust cap is significant, the stiffness of the suspension varies along the stroke of the voice coil. The parameter is known as  $C_{MS}(x)$ . This variation, or nonlinearity, can play a significant role in the distortion created by the speaker.

This model performs shape optimization of the design of the spider, a thin membrane-like mechanical element, which is a part of the suspension of the loudspeaker. By changing the shape of the spider, it is possible to create a suspension system that behaves linearly (having a nearly constant stiffness  $C_{MS}$ ) all through the range of movement of the voice coil.

The model sets up constraints in the shape variables to make sure that the thickness of the spider remains constant. The final design features a loudspeaker suspension that behaves marginally nonlinearly through the voice coil stroke. This is an improvement over the traditional design, as nonlinearities in the mechanical behavior of the suspension introduce distortion when reproducing signals of large amplitude.

The geometry and simulation parameters are similar to those used in the tutorial [Loudspeaker Driver — Frequency-Domain Analysis](#). More insight into the vibroacoustics analysis of that geometry can be gained by reading the documentation of that model.

This tutorial model illustrates:

- How to obtain the compliance curve of a loudspeaker
- How geometric nonlinearity can be used in an optimization problem
- How the shape of a boundary can be carried over to another boundary to reflect manufacturing constraints, in this case a constant thickness
- How a single component and physics can be used to capture two different designs

## Model Definition

The suspension of a loudspeaker is designed to keep the speaker cone in place and avoid any rocking movement of the voice coil. [Figure 1](#) shows the main components of a loudspeaker, whith the suspension system composed of the surround and the spider.

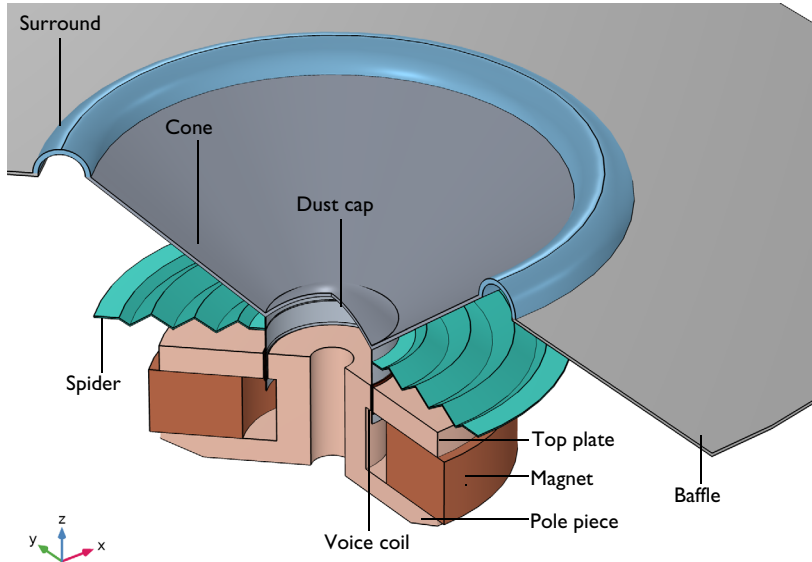

*Figure 1: Geometry of the modeled loudspeaker driver.*

When loudspeakers are excited at high frequencies, the displacement of the voice coil is relatively small. This means that at high frequencies, the compliance of the suspension along the path of the coil is almost constant. At low frequencies, the voice coil displacement becomes significant and the variation of the compliance,  $C_{MS}(x)$ , becomes more relevant. This variation of the compliance along the path of the coil is an undesired effect as it introduces distortion in the speaker. This effect is further explained in [Figure 2](#).

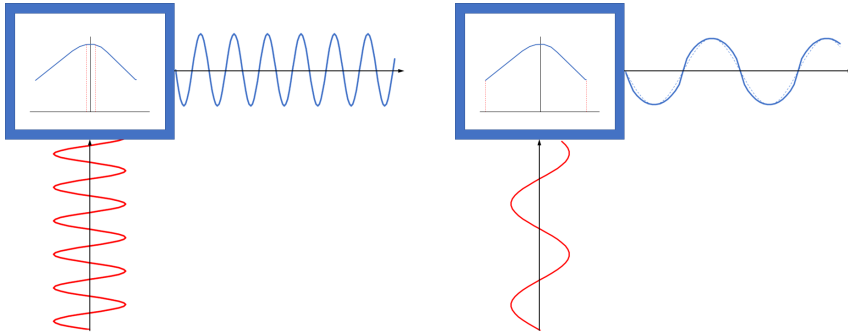

*Figure 2: Displacement of the voice coil (blue curves along the horizontal axis) when a high frequency (left) and low frequency (right) current travels through the voice coil (red curves along the vertical axis). At high frequencies, the displacement of the voice coil is small, meaning that the compliance remains almost constant through the movement, producing negligible distortion. At low frequencies, the large displacement of the coil means that the compliance will vary along the path, generating distortion in the displacement and the generated sound.*

Although novelty designs exist, most loudspeakers use spiders made of a cloth membrane formed in a concentric zigzag pattern around the former. This pattern is included in the cloth to increase the compliance of the spider and make possible a large stroke of the voice coil, which is needed to produce sound at low frequencies. [Figure 1](#) shows a traditional spider design.

The first study in the model analyzes a traditional design to include as a reference. In the second study, starting from a flat design, a shape optimization problem is defined to obtain a suspension system that behaves linearly through the stroke of the voice coil, that is, it ideally has a constant compliance  $C_{MS}$ .

## Results and Discussion

The von Mises stress distribution of a traditional spider is shown in Figure 3. Note that both the surround and the spider show deformation, as both elements contribute to the total compliance of the suspension system.

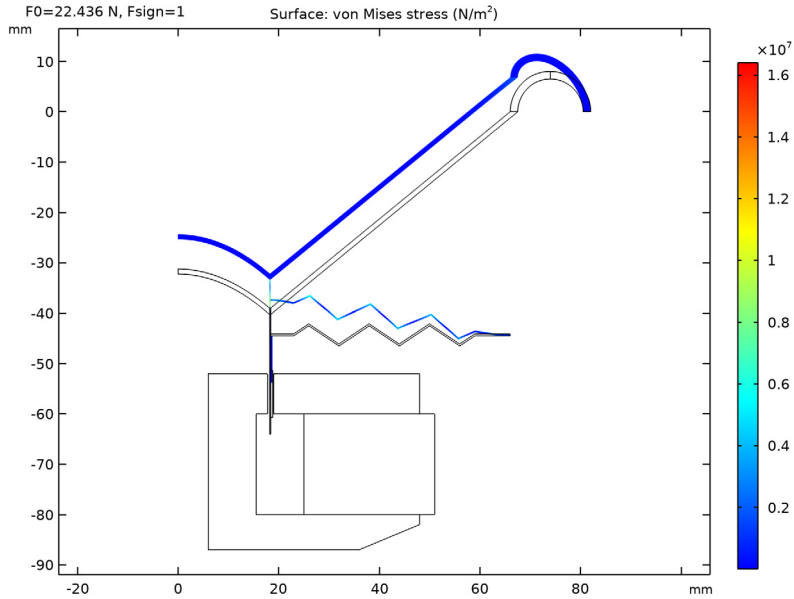

Figure 3: von Mises stress of the traditional spider.

The shape optimization study starts with a flat design of the spider and improves the objective by changing the shape of the bottom boundary. The objective is to minimize the difference between the compliance of the suspension system from an ideal linear suspension system. The change of the bottom boundary is carried over to the top boundary using a *General Extrusion* operator. The deformation of the top boundary accounts for the displacement and change in the normal direction of the bottom surface to guarantee that the thickness of the spider remains constant.

Figure 4 shows the relative normal boundary displacement and the von Mises stress of the optimized design.

Figure 5 shows the force versus displacement and compliance curves of the traditional design, an idealized design, and the optimized design.

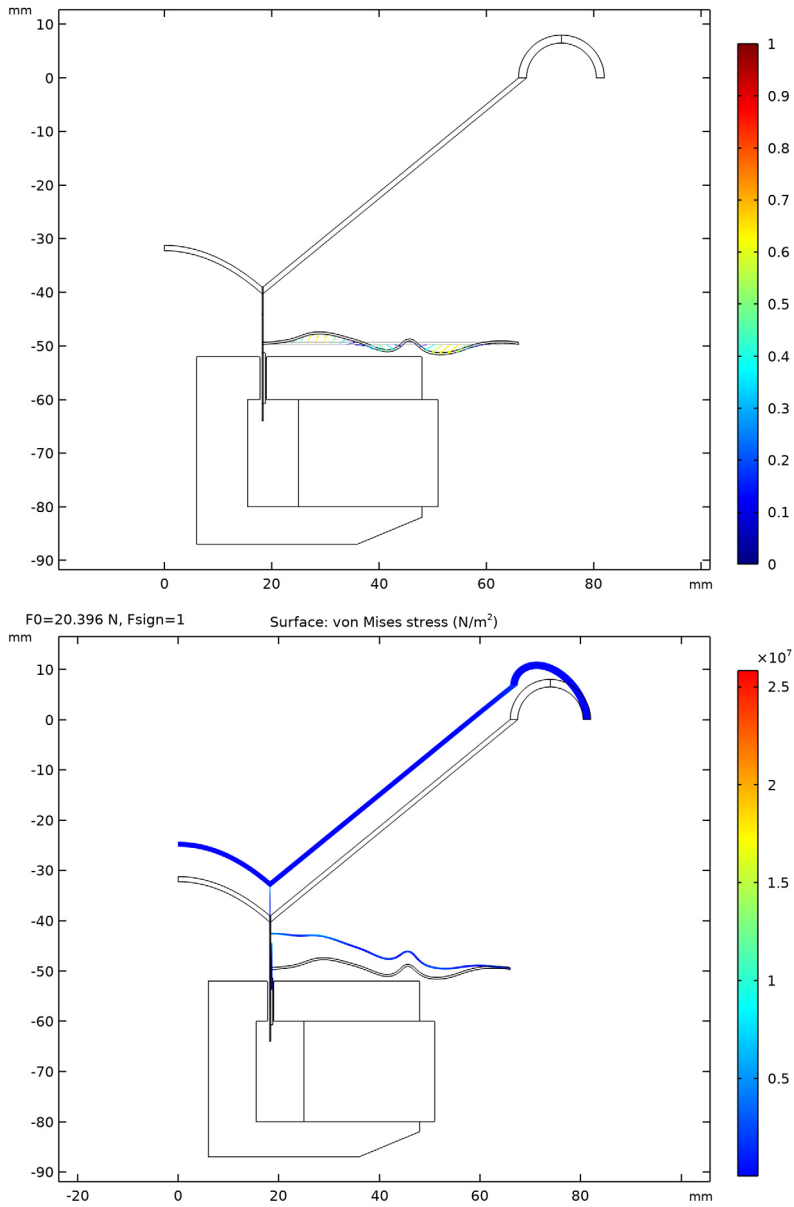

Figure 4: Relative normal displacement and von Mises stress of the optimized design.

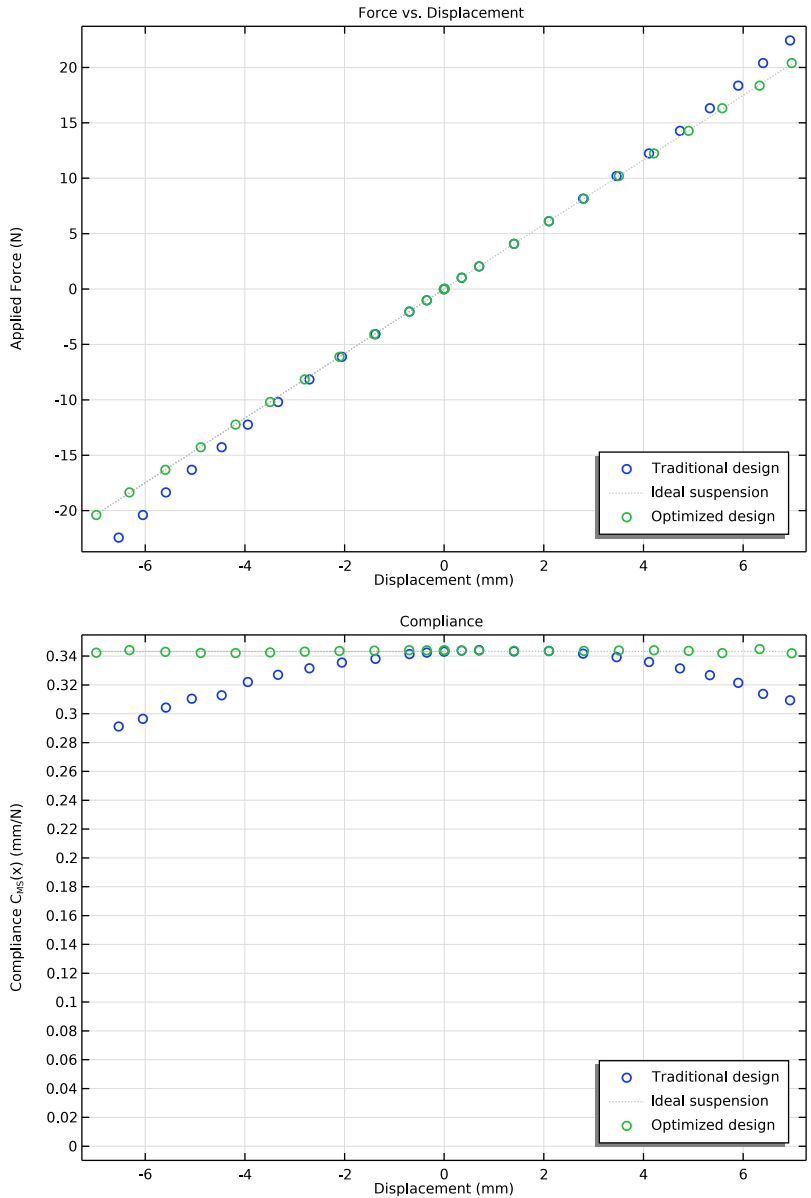
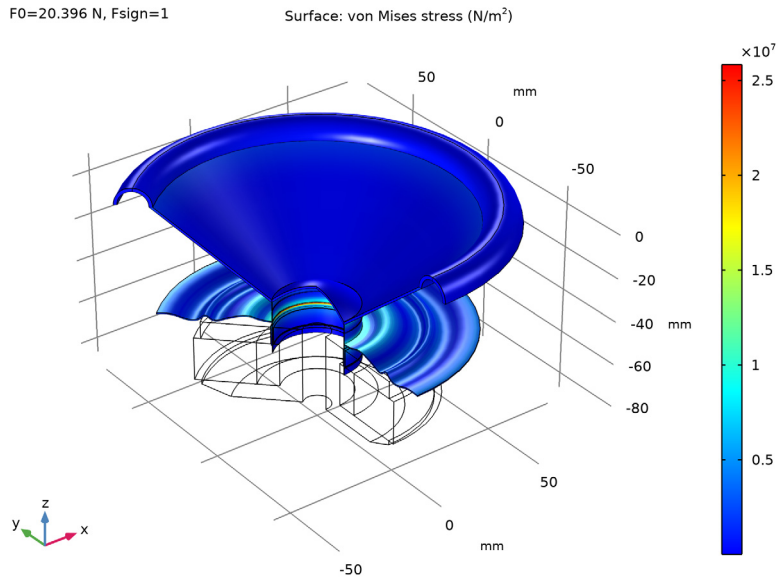

Figure 5: Force versus displacement and compliance curve of a traditional design (blue dots), an ideal suspension (gray line) and the optimized design (green dots). Note how the behavior of the traditional design deviates from the ideal behavior as the displacement increases.



*Figure 6: Revolved geometry of the optimized design.*

The von Mises stress distribution of the revolved optimized design is shown in [Figure 6](#).

This model demonstrates an efficient approach to optimize nonlinear structural problems where the performance through the different points of loading is also relevant to measure the overall performance. It also demonstrates how optimization can be used to obtain novel designs using traditional materials and manufacturing techniques, significantly improving the performance.

### *Notes About the COMSOL Implementation*

---

#### **USING A SINGLE COMPONENT AND PHYSICS TO REPRESENT TWO DESIGNS**

The model uses different boundary conditions to represent two designs using a single geometry and the same physics. When using this type of approach, it is important to pay attention to the validity of the approach for the analysis of interest. In this case, for example, it is important to note that the approach is only valid for analyzing the static stiffness of the model, as the mass of the two designs will be included as moving masses if a frequency domain analysis was used instead. This model is also very light and runs fast,



but the computational implication of including part of the model that is not relevant for the analysis should be considered in larger models.

### USING GENERAL EXTRUSION

A general extrusion coupling operator is used to carry over the shape changes from the bottom boundary to the top boundary. A set of variables under the **Angle Variables** group compute the change in the normal direction of the bottom boundary to make sure that the thickness remains constant through the spider domain.

### USING DOMAIN PROBES TO COMPUTE THE OPTIMIZATION OBJECTIVES

The objective of the optimization is based on a domain probe. The displacement and stiffness are computed through this domain probe and are used in the optimization objective.

---

**Application Library path:** Acoustics\_Module/Optimization/  
loudspeaker\_spider\_optimization

---

### *Modeling Instructions*



---

From the **File** menu, choose **New**.

#### NEW



In the **New** window, click  **Model Wizard**.

#### MODEL WIZARD

- 1 In the **Model Wizard** window, click  **2D Axisymmetric**.
- 2 In the **Select Physics** tree, select **Structural Mechanics>Solid Mechanics (solid)**.
- 3 Click **Add**.
- 4 Click  **Study**.
- 5 In the **Select Study** tree, select **General Studies>Stationary**.
- 6 Click  **Done**.

#### GEOMETRY I

- 1 In the **Model Builder** window, under **Component 1 (comp1)** click **Geometry 1**.
- 2 In the **Settings** window for **Geometry**, locate the **Units** section.

- 3 From the **Length unit** list, choose **mm**.
- 4 In the **Geometry** toolbar, click  **Insert Sequence**.
- 5 Browse to the model's Application Libraries folder and double-click the file `loudspeaker_spider_optimization_geom_sequence.mph`.
- 6 In the **Geometry** toolbar, click  **Build All**.

## GLOBAL DEFINITIONS

### *Parameters I*

- 1 In the **Model Builder** window, under **Global Definitions** click **Parameters I**.
- 2 In the **Settings** window for **Parameters**, locate the **Parameters** section.
- 3 Click  **Load from File**.
- 4 Browse to the model's Application Libraries folder and double-click the file `loudspeaker_spider_optimization_parameters.txt`.

## DEFINITIONS

### *Optimization Objective*

- 1 In the **Model Builder** window, under **Component 1 (comp1)** right-click **Definitions** and choose **Variables**.
- 2 In the **Settings** window for **Variables**, type `Optimization Objective` in the **Label** text field.
- 3 Locate the **Variables** section. In the table, enter the following settings:

Name	Expression	Unit	Description
obj_1	$(\text{susp\_stiff} - \text{susp\_stiff0})^2$		Optimization objective

### *Angle Variables*

- 1 In the **Model Builder** window, right-click **Definitions** and choose **Variables**.
- 2 In the **Settings** window for **Variables**, type `Angle Variables` in the **Label** text field.
- 3 Locate the **Geometric Entity Selection** section. From the **Geometric entity level** list, choose **Boundary**.
- 4 Select `Boundary 32` only.

5 Locate the **Variables** section. In the table, enter the following settings:

Name	Expression	Unit	Description
angle	$\text{atan2}(nZ, nR)$	rad	Normal angle
step	$\text{if}(s < 0.1, s/0.1, \text{if}(0.9 < s, (1-s)/0.1, 1))$		Angle smoothing step
nRApprox	$\cos(-\pi/2 * (1-\text{step}) + \text{angle} * \text{step})$		R component of the normal
nZApprox	$\sin(-\pi/2 * (1-\text{step}) + \text{angle} * \text{step})$		Z component of the normal

#### Domain Probe 1 (dom1)

- 1 In the **Definitions** toolbar, click  **Probes** and choose **Domain Probe**.
- 2 In the **Settings** window for **Domain Probe**, type `susp_disp` in the **Variable name** text field.
- 3 Locate the **Source Selection** section. From the **Selection** list, choose **Voice Coil**.
- 4 Locate the **Expression** section. In the **Expression** text field, type `w`.
- 5 Select the **Description** check box.
- 6 In the associated text field, type `Displacement`.

#### Domain Probe 2 (dom2)

- 1 In the **Definitions** toolbar, click  **Probes** and choose **Domain Probe**.
- 2 In the **Settings** window for **Domain Probe**, type `susp_stiff` in the **Variable name** text field.
- 3 Locate the **Source Selection** section. From the **Selection** list, choose **Voice Coil**.
- 4 Locate the **Expression** section. In the **Expression** text field, type `F0*Fsign/w`.
- 5 From the **Table and plot unit** list, choose **N/mm**.
- 6 Select the **Description** check box.
- 7 In the associated text field, type `Suspension stiffness`.

#### General Extrusion 1 (genext1)

- 1 In the **Definitions** toolbar, click  **Nonlocal Couplings** and choose **General Extrusion**.
- 2 In the **Settings** window for **General Extrusion**, locate the **Source Selection** section.
- 3 From the **Geometric entity level** list, choose **Boundary**.
- 4 Select `Boundary 32` only.
- 5 Locate the **Destination Map** section. In the **r-expression** text field, type `Rg`.

- 6 In the **z-expression** text field, type  $-49.7[\text{mm}]$ .
- 7 Locate the **Source** section. From the **Source frame** list, choose **Geometry (Rg, PHlg, Zg)**.

#### *Free Shape Domain I*

- 1 In the **Definitions** toolbar, click  **Optimization** and choose **Free Shape Domain**.
- 2 In the **Settings** window for **Free Shape Domain**, locate the **Domain Selection** section.
- 3 From the **Selection** list, choose **Shape Optimization**.

#### *Free Shape Boundary I*

- 1 In the **Definitions** toolbar, click  **Optimization** and choose **Free Shape Boundary**.
- 2 Select Boundary 32 only.
- 3 In the **Settings** window for **Free Shape Boundary**, locate the **Control Variable Settings** section.
- 4 In the  $d_{\max}$  text field, type  $\text{max\_disp}$ .
- 5 Locate the **Filtering** section. In the  $R_{\min}$  text field, type  $\text{max\_disp}$ .



#### *Prescribed Deformation I*

- 1 In the **Definitions** toolbar, click  **Deformed Geometry** and choose **Prescribed Deformation**.
- 2 In the **Settings** window for **Prescribed Deformation**, locate the **Geometric Entity Selection** section.
- 3 From the **Geometric entity level** list, choose **Boundary**.
- 4 Select Boundary 34 only.
- 5 Locate the **Prescribed Deformation** section. Specify the  $dx$  vector as

$\text{genext1}(\text{fsd1.dRg}-\text{nRAp} \text{prox} * 0.4[\text{mm}])$	R
$\text{genext1}(\text{fsd1.dZg}-\text{nZAp} \text{prox} * 0.4[\text{mm}]) - 0.4[\text{mm}]$	Z

- 6 Right-click **Prescribed Deformation I** and choose **Browse Materials**.

#### **MATERIAL BROWSER**

- 1 In the **Material Browser** window, click  **Import Material Library**.
- 2 From the Application Libraries root, browse to the folder `Acoustics_Module/Electroacoustic_Transducers` and double-click the file `loudspeaker_driver_materials.mph`.
- 3 Click  **Done**.

## MATERIALS

In the **Home** toolbar, click  **Windows** and choose **Add Material from Library**.

## ADD MATERIAL

- 1 Go to the **Add Material** window.
- 2 In the tree, select **loudspeaker driver materials>Composite**.
- 3 Click **Add to Component** in the window toolbar.

## MATERIALS

*Composite (mat1)*

- 1 In the **Settings** window for **Material**, locate the **Geometric Entity Selection** section.
- 2 From the **Selection** list, choose **Composite**.

## ADD MATERIAL

- 1 Go to the **Add Material** window.
- 2 In the tree, select **loudspeaker driver materials>Cloth**.
- 3 Click **Add to Component** in the window toolbar.

## MATERIALS

*Cloth (mat2)*

- 1 In the **Settings** window for **Material**, locate the **Geometric Entity Selection** section.
- 2 From the **Selection** list, choose **Cloth**.

## ADD MATERIAL

- 1 Go to the **Add Material** window.
- 2 In the tree, select **loudspeaker driver materials>Foam**.
- 3 Click **Add to Component** in the window toolbar.

## MATERIALS

*Foam (mat3)*

- 1 In the **Settings** window for **Material**, locate the **Geometric Entity Selection** section.
- 2 From the **Selection** list, choose **Foam**.

## ADD MATERIAL

- 1 Go to the **Add Material** window.

- 2 In the tree, select **loudspeaker driver materials>Coil**.
- 3 Click **Add to Component** in the window toolbar.

## MATERIALS

### *Coil (mat4)*

- 1 In the **Settings** window for **Material**, locate the **Geometric Entity Selection** section.
- 2 From the **Selection** list, choose **Voice Coil**.

## ADD MATERIAL

- 1 Go to the **Add Material** window.
- 2 In the tree, select **loudspeaker driver materials>Glass Fiber**.
- 3 Click **Add to Component** in the window toolbar.
- 4 In the **Home** toolbar, click  **Add Material** to close the **Add Material** window.

## MATERIALS

### *Glass Fiber (mat5)*

- 1 In the **Settings** window for **Material**, locate the **Geometric Entity Selection** section.
- 2 From the **Selection** list, choose **Former**.

## SOLID MECHANICS (SOLID)

- 1 In the **Model Builder** window, under **Component 1 (comp1)** click **Solid Mechanics (solid)**.
- 2 In the **Settings** window for **Solid Mechanics**, locate the **Domain Selection** section.
- 3 From the **Selection** list, choose **Structural Domains**.

### *Body Load 1*

- 1 In the **Physics** toolbar, click  **Domains** and choose **Body Load**.
- 2 In the **Settings** window for **Body Load**, locate the **Domain Selection** section.
- 3 From the **Selection** list, choose **Voice Coil**.
- 4 Locate the **Force** section. From the **Load type** list, choose **Total force**.
- 5 Specify the  $\mathbf{F}_{\text{tot}}$  vector as

0	r
$F_0 \cdot F_{\text{sign}}$	z

### *Fixed Constraint 1*

- 1 In the **Physics** toolbar, click  **Boundaries** and choose **Fixed Constraint**.

- 2 In the **Settings** window for **Fixed Constraint**, locate the **Boundary Selection** section.
- 3 From the **Selection** list, choose **Fixed Boundaries 1**.

*Fixed Constraint 2*

- 1 In the **Physics** toolbar, click  **Boundaries** and choose **Fixed Constraint**.
- 2 In the **Settings** window for **Fixed Constraint**, locate the **Boundary Selection** section.
- 3 From the **Selection** list, choose **Fixed Boundaries 2**.

**MESH 1**

*Mapped 1*

- 1 In the **Mesh** toolbar, click  **Mapped**.
- 2 In the **Settings** window for **Mapped**, locate the **Domain Selection** section.
- 3 From the **Geometric entity level** list, choose **Domain**.
- 4 From the **Selection** list, choose **Structural Domains**.

*Size 1*

- 1 Right-click **Mapped 1** and choose **Size**.
- 2 In the **Settings** window for **Size**, locate the **Element Size** section.
- 3 Click the **Custom** button.
- 4 Locate the **Element Size Parameters** section. Select the **Maximum element size** check box.
- 5 In the associated text field, type `mesh_size`.

*Distribution 1*

- 1 In the **Model Builder** window, right-click **Mapped 1** and choose **Distribution**.
- 2 In the **Settings** window for **Distribution**, locate the **Boundary Selection** section.
- 3 From the **Selection** list, choose **Fixed Boundaries 1**.
- 4 Locate the **Distribution** section. In the **Number of elements** text field, type 2.

*Distribution 2*

- 1 Right-click **Mapped 1** and choose **Distribution**.
- 2 In the **Settings** window for **Distribution**, locate the **Boundary Selection** section.
- 3 From the **Selection** list, choose **Fixed Boundaries 2**.
- 4 Locate the **Distribution** section. In the **Number of elements** text field, type 2.
- 5 Click  **Build All**.



*Free Triangular I*

- 1 In the **Mesh** toolbar, click  **Free Triangular**.
- 2 In the **Settings** window for **Free Triangular**, click  **Build All**.

**STUDY I - TRADITIONAL DESIGN**

- 1 In the **Model Builder** window, click **Study I**.
- 2 In the **Settings** window for **Study**, type Study 1 - Traditional Design in the **Label** text field.

*Step 1: Stationary*

- 1 In the **Model Builder** window, under **Study I - Traditional Design** click **Step 1: Stationary**.
- 2 In the **Settings** window for **Stationary**, locate the **Study Settings** section.
- 3 Select the **Include geometric nonlinearity** check box.
- 4 Click to expand the **Results While Solving** section. From the **Probes** list, choose **None**.
- 5 Locate the **Physics and Variables Selection** section. Select the **Modify model configuration for study step** check box.
- 6 In the **Physics and variables selection tree**, select **Component 1 (comp1)>Solid Mechanics (solid), Controls spatial frame>Fixed Constraint 2**.
- 7 Click  **Disable**.
- 8 Click to expand the **Study Extensions** section. Select the **Auxiliary sweep** check box.
- 9 From the **Sweep type** list, choose **All combinations**.
- 10 Click  **Add**.
- 11 In the table, enter the following settings:

Parameter name	Parameter value list	Parameter unit
Fsign (Force sign)	-1 1	

- 12 Click  **Add**.

- 13 In the table, enter the following settings:

Parameter name	Parameter value list	Parameter unit
F0 (Force parameter for the sweep)	Fmax/1000 Fmax/20 range(Fmax/10, Fmax/10, Fmax*1.15)	N

- 14 In the **Home** toolbar, click  **Compute**.



## RESULTS

### *Study 1 - Traditional Design/Solution 1 (sol1)*

In the **Model Builder** window, expand the **Results>Datasets** node, then click **Study 1 - Traditional Design/Solution 1 (sol1)**.

### *Selection*

- 1 In the **Results** toolbar, click  **Attributes** and choose **Selection**.
- 2 In the **Settings** window for **Selection**, locate the **Geometric Entity Selection** section.
- 3 From the **Geometric entity level** list, choose **Domain**.
- 4 Select Domains 1–11 and 13–18 only.

### *Applied Loads (solid), Shape Optimization*

- 1 In the **Model Builder** window, under **Results**, Ctrl-click to select **Applied Loads (solid)** and **Shape Optimization**.
- 2 Right-click and choose **Delete**.

### *Stress (solid), Stress, 3D (solid)*

- 1 In the **Model Builder** window, under **Results**, Ctrl-click to select **Stress (solid)** and **Stress, 3D (solid)**.
- 2 Right-click and choose **Group**.

### *Traditional Design Results*

In the **Settings** window for **Group**, type Traditional Design Results in the **Label** text field.

## ROOT

In the **Home** toolbar, click  **Windows** and choose **Add Study**.

## ADD STUDY

- 1 Go to the **Add Study** window.
- 2 Find the **Studies** subsection. In the **Select Study** tree, select **Empty Study**.
- 3 Click **Add Study** in the window toolbar.
- 4 In the **Home** toolbar, click  **Add Study** to close the **Add Study** window.

## STUDY 2

### *Shape Optimization*

- 1 In the **Study** toolbar, click  **Optimization** and choose **Shape Optimization**.

- 2 In the **Settings** window for **Shape Optimization**, locate the **Objective Function** section.
- 3 From the **Solution** list, choose **Maximum of objectives**.
- 4 Locate the **Optimization Solver** section. Clear the **Move limits** check box.
- 5 Locate the **Objective Function** section. In the table, enter the following settings:

Expression	Description
$\log_{10}(\text{comp1.obj}_1)$	

- 6 Locate the **Output While Solving** section. From the **Probes** list, choose **None**.

## STUDY 1 - TRADITIONAL DESIGN

*Step 1: Stationary*

- In the **Model Builder** window, under **Study 1 - Traditional Design** right-click **Step 1: Stationary** and choose **Copy**.

## STUDY 2

- In the **Model Builder** window, right-click **Study 2** and choose **Paste Stationary**.

*Step 1: Stationary*

- 1 In the **Settings** window for **Stationary**, locate the **Physics and Variables Selection** section.
- 2 In the **Physics and variables selection** tree, select **Component 1 (comp1)> Solid Mechanics (solid), Controls spatial frame>Fixed Constraint 1**.
- 3 Click  **Disable**.
- 4 In the **Physics and variables selection** tree, select **Component 1 (comp1)> Solid Mechanics (solid), Controls spatial frame>Fixed Constraint 2**.
- 5 Click  **Enable**.
- 6 Locate the **Study Extensions** section. In the table, enter the following settings:

Parameter name	Parameter value list	Parameter unit
F0 (Force parameter for the sweep)	Fmax/1000 Fmax/20 range(Fmax/10, Fmax/10, Fmax)	N

- 7 In the **Model Builder** window, click **Study 2**.
- 8 In the **Settings** window for **Study**, type Study 2 - Optimization in the **Label** text field.
- 9 In the **Study** toolbar, click  $t=0$  **Get Initial Value**.

## RESULTS

### *Applied Loads (solid)*

In the **Model Builder** window, under **Results** right-click **Applied Loads (solid)** and choose **Delete**.

### *Study 2 - Optimization/Solution 2 (sol2)*

In the **Model Builder** window, click **Study 2 - Optimization/Solution 2 (sol2)**.

### *Selection*

- 1 In the **Results** toolbar, click  **Attributes** and choose **Selection**.
- 2 In the **Settings** window for **Selection**, locate the **Geometric Entity Selection** section.
- 3 From the **Geometric entity level** list, choose **Domain**.
- 4 Select Domains 1–12 and 14–18 only.

### *Arrow Line 1*

- 1 In the **Model Builder** window, expand the **Results>Shape Optimization** node, then click **Arrow Line 1**.
- 2 In the **Settings** window for **Arrow Line**, locate the **Arrow Positioning** section.
- 3 From the **Placement** list, choose **Gauss points**.

### *Shape Optimization, Stress (solid) 1, Stress, 3D (solid) 1*

- 1 In the **Model Builder** window, under **Results**, Ctrl-click to select **Stress (solid) 1**, **Stress, 3D (solid) 1**, and **Shape Optimization**.
- 2 Right-click and choose **Group**.

### *Optimization Results*

In the **Settings** window for **Group**, type Optimization Results in the **Label** text field.

## STUDY 2 - OPTIMIZATION

### *Shape Optimization*

- 1 In the **Model Builder** window, under **Study 2 - Optimization** click **Shape Optimization**.
- 2 In the **Settings** window for **Shape Optimization**, locate the **Output While Solving** section.
- 3 Select the **Plot** check box.
- 4 From the **Plot group** list, choose **Shape Optimization**.
- 5 In the **Home** toolbar, click  **Compute**.

## RESULTS

### *Force vs. Displacement*

- 1 In the **Home** toolbar, click  **Add Plot Group** and choose **ID Plot Group**.
- 2 In the **Settings** window for **ID Plot Group**, type Force vs. Displacement in the **Label** text field.
- 3 Locate the **Plot Settings** section. Select the **x-axis label** check box.
- 4 In the associated text field, type Displacement (mm).
- 5 Select the **y-axis label** check box.
- 6 In the associated text field, type Applied Force (N).
- 7 Click to expand the **Title** section. From the **Title type** list, choose **Label**.
- 8 Locate the **Legend** section. From the **Position** list, choose **Lower right**.

### *Global I*

- 1 Right-click **Force vs. Displacement** and choose **Global**.
- 2 In the **Settings** window for **Global**, locate the **y-Axis Data** section.
- 3 In the table, enter the following settings:

Expression	Unit	Description
F0*Fsign		

- 4 Locate the **x-Axis Data** section. From the **Axis source data** list, choose **All solutions**.
- 5 From the **Parameter** list, choose **Expression**.
- 6 In the **Expression** text field, type susp\_disp.
- 7 Click to expand the **Legends** section. From the **Legends** list, choose **Manual**.
- 8 In the table, enter the following settings:

Legends
Traditional design

- 9 Click to expand the **Coloring and Style** section. Find the **Line style** subsection. From the **Line** list, choose **None**.
- 10 Find the **Line markers** subsection. From the **Marker** list, choose **Circle**.
- 11 From the **Positioning** list, choose **In data points**.
- 12 In the **Force vs. Displacement** toolbar, click  **Plot**.

### Global 2

- 1 Right-click **Global 1** and choose **Duplicate**.
- 2 In the **Settings** window for **Global**, locate the **Data** section.
- 3 From the **Dataset** list, choose **Study 2 - Optimization/Solution 2 (sol2)**.
- 4 Locate the **x-Axis Data** section. From the **Axis source data** list, choose **All solutions**.
- 5 Locate the **y-Axis Data** section. In the table, enter the following settings:

Expression	Unit	Description
susp_disp/susp_comp0	N	

- 6 Locate the **Coloring and Style** section. Find the **Line style** subsection. From the **Line** list, choose **Dotted**.
- 7 From the **Color** list, choose **Gray**.
- 8 Find the **Line markers** subsection. From the **Marker** list, choose **None**.
- 9 Locate the **Legends** section. In the table, enter the following settings:

Legends
Ideal suspension

### Global 3

- 1 In the **Model Builder** window, under **Results>Force vs. Displacement** right-click **Global 1** and choose **Duplicate**.
- 2 In the **Settings** window for **Global**, locate the **Data** section.
- 3 From the **Dataset** list, choose **Study 2 - Optimization/Solution 2 (sol2)**.
- 4 Locate the **x-Axis Data** section. From the **Axis source data** list, choose **All solutions**.
- 5 Locate the **Legends** section. In the table, enter the following settings:

Legends
Optimized design

- 6 In the **Force vs. Displacement** toolbar, click  **Plot**.

The image should look like [Figure 5](#).

### Compliance

- 1 In the **Model Builder** window, right-click **Force vs. Displacement** and choose **Duplicate**.
- 2 In the **Settings** window for **ID Plot Group**, type Compliance in the **Label** text field.

- 3 Locate the **Plot Settings** section. In the **y-axis label** text field, type Compliance  $C(x)$  (mm/N).

#### Global 1

- 1 In the **Model Builder** window, expand the **Compliance** node, then click **Global 1**.
- 2 In the **Settings** window for **Global**, locate the **y-Axis Data** section.
- 3 In the table, enter the following settings:

Expression	Unit	Description
1/susp_stiff	mm/N	

#### Global 2

- 1 In the **Model Builder** window, click **Global 2**.
- 2 In the **Settings** window for **Global**, locate the **y-Axis Data** section.
- 3 In the table, enter the following settings:

Expression	Unit	Description
1/susp_stiff0	mm/N	

#### Global 3

- 1 In the **Model Builder** window, click **Global 3**.
- 2 In the **Settings** window for **Global**, locate the **y-Axis Data** section.
- 3 In the table, enter the following settings:

Expression	Unit	Description
1/susp_stiff	mm/N	

- 4 In the **Compliance** toolbar, click  **Plot**.

#### Annotation 1

- 1 In the **Model Builder** window, right-click **Compliance** and choose **Annotation**.
- 2 In the **Settings** window for **Annotation**, locate the **Coloring and Style** section.
- 3 Clear the **Show point** check box.
- 4 In the **Compliance** toolbar, click  **Plot**.

The image should look like [Figure 5](#).

#### Stress, 3D (solid)

- In the **Model Builder** window, expand the **Results>Traditional Design Results>Stress, 3D (solid)** node.

### *Deformation*

- 1 In the **Model Builder** window, expand the **Results>Traditional Design Results>Stress, 3D (solid)>Surface 1** node.
- 2 Right-click **Deformation** and choose **Delete**.

### *Stress, 3D (solid) 1*

In the **Model Builder** window, expand the **Results>Optimization Results>Stress, 3D (solid) 1** node.

### *Deformation*

- 1 In the **Model Builder** window, expand the **Results>Optimization Results>Stress, 3D (solid) 1>Surface 1** node.
- 2 Right-click **Deformation** and choose **Delete**.
- 3 In the **Stress, 3D (solid) 1** toolbar, click  **Plot**.

The image should look like [Figure 6](#).

## *Geometry Modeling Instructions*

---

If you want to create the geometry yourself, follow these steps.

From the **File** menu, choose **New**.

### **NEW**

In the **New** window, click  **Blank Model**.

### **ADD COMPONENT**

In the **Home** toolbar, click  **Add Component** and choose **2D Axisymmetric**.

### **GEOMETRY 1**

#### *Circle 1 (c1)*

- 1 In the **Geometry** toolbar, click  **Circle**.
- 2 In the **Settings** window for **Circle**, locate the **Size and Shape** section.
- 3 In the **Radius** text field, type 130[mm].
- 4 Click to expand the **Layers** section. In the table, enter the following settings:

Layer name	Thickness (m)
Layer 1	15[mm]

### Circle 2 (c2)

- 1 In the **Geometry** toolbar, click  **Circle**.
- 2 In the **Settings** window for **Circle**, locate the **Size and Shape** section.
- 3 In the **Radius** text field, type 8[mm].
- 4 In the **Sector angle** text field, type 180.
- 5 Locate the **Position** section. In the **r** text field, type 74[mm].
- 6 Locate the **Layers** section. In the table, enter the following settings:

Layer name	Thickness (m)
Layer 1	1.5[mm]



### Delete Entities 1 (del1)

- 1 In the **Model Builder** window, right-click **Geometry 1** and choose **Delete Entities**.
- 2 On the object **c2**, select Boundaries 2–4 only.
- 3 In the **Settings** window for **Delete Entities**, locate the **Selections of Resulting Entities** section.
- 4 Select the **Resulting objects selection** check box.

### Rectangle 1 (r1)

- 1 In the **Geometry** toolbar, click  **Rectangle**.
- 2 In the **Settings** window for **Rectangle**, locate the **Size and Shape** section.
- 3 In the **Width** text field, type 70[mm].
- 4 In the **Height** text field, type 1[mm].
- 5 Locate the **Position** section. In the **r** text field, type 80.5[mm].
- 6 In the **z** text field, type -1[mm].

### Difference 1 (dif1)

- 1 In the **Geometry** toolbar, click  **Booleans and Partitions** and choose **Difference**.
- 2 Select the object **c1** only.
- 3 In the **Settings** window for **Difference**, locate the **Difference** section.
- 4 Find the **Objects to subtract** subsection. Select the  **Activate Selection** toggle button.
- 5 Select the object **r1** only.

### Rectangle 2 (r2)

- 1 In the **Geometry** toolbar, click  **Rectangle**.
- 2 In the **Settings** window for **Rectangle**, locate the **Size and Shape** section.



- 3 In the **Width** text field, type 42[mm].
- 4 In the **Height** text field, type 35[mm].
- 5 Locate the **Position** section. In the **r** text field, type 6[mm].
- 6 In the **z** text field, type -87[mm].

*Rectangle 3 (r3)*

- 1 In the **Geometry** toolbar, click  **Rectangle**.
- 2 In the **Settings** window for **Rectangle**, locate the **Size and Shape** section.
- 3 In the **Width** text field, type 35.5[mm].
- 4 In the **Height** text field, type 20[mm].
- 5 Locate the **Position** section. In the **r** text field, type 15.5[mm].
- 6 In the **z** text field, type -80[mm].

*Rectangle 4 (r4)*

- 1 In the **Geometry** toolbar, click  **Rectangle**.
- 2 In the **Settings** window for **Rectangle**, locate the **Size and Shape** section.
- 3 In the **Width** text field, type 1.2[mm].
- 4 In the **Height** text field, type 8[mm].
- 5 Locate the **Position** section. In the **r** text field, type 17.8[mm].
- 6 In the **z** text field, type -60[mm].



*Rectangle 5 (r5)*

- 1 In the **Geometry** toolbar, click  **Rectangle**.
- 2 In the **Settings** window for **Rectangle**, locate the **Size and Shape** section.
- 3 In the **Width** text field, type 26[mm].
- 4 In the **Height** text field, type 20[mm].
- 5 Locate the **Position** section. In the **r** text field, type 25[mm].
- 6 In the **z** text field, type -80[mm].

*Polygon 1 (p01)*

- 1 In the **Geometry** toolbar, click  **Polygon**.
- 2 In the **Settings** window for **Polygon**, locate the **Coordinates** section.
- 3 From the **Data source** list, choose **Vectors**.
- 4 In the **r** text field, type 48[mm] 36[mm] 36[mm] 48[mm].
- 5 In the **z** text field, type -82[mm] -87[mm] -87[mm] -87[mm].

### *Difference 2 (dif2)*

- 1 In the **Geometry** toolbar, click  **Booleans and Partitions** and choose **Difference**.
- 2 Select the object **r2** only.
- 3 In the **Settings** window for **Difference**, locate the **Difference** section.
- 4 Find the **Objects to subtract** subsection. Select the  **Activate Selection** toggle button.
- 5 Select the objects **pol1**, **r3**, and **r4** only.
- 6 Locate the **Selections of Resulting Entities** section. Select the **Resulting objects selection** check box.

### *Rectangle 6 (r6)*

- 1 In the **Geometry** toolbar, click  **Rectangle**.
- 2 In the **Settings** window for **Rectangle**, locate the **Size and Shape** section.
- 3 In the **Width** text field, type 0.2[mm].
- 4 In the **Height** text field, type 25[mm].
- 5 Locate the **Position** section. In the **r** text field, type 18.2[mm].
- 6 In the **z** text field, type -64[mm].
- 7 Click to expand the **Layers** section. In the table, enter the following settings:

<b>Layer name</b>	<b>Thickness (m)</b>
Layer 1	1.26[mm]
Layer 2	3.84[mm]
Layer 3	0.4[mm]

- 8 Clear the **Layers on bottom** check box.
- 9 Select the **Layers on top** check box.

### *Rectangle 7 (r7)*

- 1 In the **Geometry** toolbar, click  **Rectangle**.
- 2 In the **Settings** window for **Rectangle**, locate the **Size and Shape** section.
- 3 In the **Width** text field, type 0.6[mm].
- 4 In the **Height** text field, type 9.4[mm].
- 5 Locate the **Position** section. In the **r** text field, type 18.2[mm].
- 6 In the **z** text field, type -60.7[mm].

### *Rectangle 8 (r8)*

- 1 In the **Geometry** toolbar, click  **Rectangle**.

- 2 In the **Settings** window for **Rectangle**, locate the **Size and Shape** section.
- 3 In the **Width** text field, type 4.6[mm].
- 4 In the **Height** text field, type 0.4[mm].
- 5 Locate the **Position** section. In the **r** text field, type 18.4[mm].
- 6 In the **z** text field, type -44.5[mm].

#### *Rectangle 9 (r9)*

- 1 In the **Geometry** toolbar, click  **Rectangle**.
- 2 In the **Settings** window for **Rectangle**, locate the **Size and Shape** section.
- 3 In the **Width** text field, type 7[mm].
- 4 In the **Height** text field, type 0.4[mm].
- 5 Locate the **Position** section. In the **r** text field, type 59[mm].
- 6 In the **z** text field, type -44.5[mm].

#### *Polygon 2 (pol2)*

- 1 In the **Geometry** toolbar, click  **Polygon**.
- 2 In the **Settings** window for **Polygon**, locate the **Coordinates** section.
- 3 From the **Data source** list, choose **Vectors**.
- 4 In the **r** text field, type 23[mm] 26[mm] 26[mm] 32[mm] 32[mm] 38[mm] 38[mm] 44[mm] 44[mm] 50[mm] 50[mm] 56[mm] 56[mm] 59[mm] 59[mm] 59[mm] 59[mm] 56[mm] 56[mm] 50[mm] 50[mm] 44[mm] 44[mm] 38[mm] 38[mm] 32[mm] 32[mm] 26[mm] 26[mm] 23[mm] 23[mm] 23[mm].
- 5 In the **z** text field, type -44.1[mm] -42.1[mm] -42.1[mm] -46.1[mm] -46.1[mm] -42.1[mm] -42.1[mm] -46.1[mm] -46.1[mm] -46.1[mm] -44.1[mm] -44.1[mm] -44.5[mm] -44.5[mm] -46.5[mm] -46.5[mm] -42.5[mm] -42.5[mm] -46.5[mm] -46.5[mm] -42.5[mm] -42.5[mm] -46.5[mm] -46.5[mm] -42.5[mm] -42.5[mm] -44.5[mm] -44.5[mm] -44.1.

#### *Union 1 (uni1)*

- 1 In the **Geometry** toolbar, click  **Booleans and Partitions** and choose **Union**.
- 2 Select the objects **pol2**, **r8**, and **r9** only.
- 3 In the **Settings** window for **Union**, locate the **Selections of Resulting Entities** section.
- 4 Select the **Resulting objects selection** check box.
- 5 Locate the **Union** section. Clear the **Keep interior boundaries** check box.

### *Polygon 3 (pol3)*

- 1 In the **Geometry** toolbar, click  **Polygon**.
- 2 In the **Settings** window for **Polygon**, locate the **Coordinates** section.
- 3 From the **Data source** list, choose **Vectors**.
- 4 In the **r** text field, type 18.4[mm] 66[mm] 66[mm] 67.5[mm] 67.5[mm] 18.4[mm] 18.4[mm] 18.4[mm].
- 5 In the **z** text field, type -39[mm] 0 0 0 0 -40.26[mm] -40.26[mm] -39[mm].

### *Quadratic Bézier 1 (qb1)*

- 1 In the **Geometry** toolbar, click  **More Primitives** and choose **Quadratic Bézier**.
- 2 In the **Settings** window for **Quadratic Bézier**, locate the **Control Points** section.
- 3 In row **1**, set **r** to -18.2[mm].
- 4 In row **3**, set **r** to 18.2[mm].
- 5 In row **1**, set **z** to -39[mm].
- 6 In row **2**, set **z** to -23.5[mm].
- 7 In row **3**, set **z** to -39[mm].
- 8 Locate the **Weights** section. In the **2** text field, type 1.

### *Line Segment 1 (ls1)*

- 1 In the **Geometry** toolbar, click  **More Primitives** and choose **Line Segment**.
- 2 In the **Settings** window for **Line Segment**, locate the **Starting Point** section.
- 3 From the **Specify** list, choose **Coordinates**.
- 4 Locate the **Endpoint** section. From the **Specify** list, choose **Coordinates**.
- 5 Locate the **Starting Point** section. In the **r** text field, type 18.2[mm].
- 6 Locate the **Endpoint** section. In the **r** text field, type 18.2[mm].
- 7 Locate the **Starting Point** section. In the **z** text field, type -39[mm].
- 8 Locate the **Endpoint** section. In the **z** text field, type -40.26[mm].

### *Quadratic Bézier 2 (qb2)*

- 1 In the **Geometry** toolbar, click  **More Primitives** and choose **Quadratic Bézier**.
- 2 In the **Settings** window for **Quadratic Bézier**, locate the **Control Points** section.
- 3 In row **1**, set **r** to 18.2[mm].
- 4 In row **3**, set **r** to -18.2[mm].
- 5 In row **1**, set **z** to -40.26[mm].

- 6 In row **2**, set **z** to -24.26[mm].
- 7 In row **3**, set **z** to -40.26[mm].
- 8 Locate the **Weights** section. In the **2** text field, type 1.

#### *Line Segment 2 (ls2)*

- 1 In the **Geometry** toolbar, click  **More Primitives** and choose **Line Segment**.
- 2 In the **Settings** window for **Line Segment**, locate the **Starting Point** section.
- 3 From the **Specify** list, choose **Coordinates**.
- 4 Locate the **Endpoint** section. From the **Specify** list, choose **Coordinates**.
- 5 Locate the **Starting Point** section. In the **r** text field, type -18.2[mm].
- 6 Locate the **Endpoint** section. In the **r** text field, type -18.2[mm].
- 7 Locate the **Starting Point** section. In the **z** text field, type -40.26[mm].
- 8 Locate the **Endpoint** section. In the **z** text field, type -39[mm].

#### *Convert to Solid 1 (csol1)*

- 1 In the **Geometry** toolbar, click  **Conversions** and choose **Convert to Solid**.
- 2 Select the objects **ls1**, **ls2**, **qb1**, and **qb2** only.

#### *Line Segment 3 (ls3)*

- 1 In the **Geometry** toolbar, click  **More Primitives** and choose **Line Segment**.
- 2 In the **Settings** window for **Line Segment**, locate the **Starting Point** section.
- 3 From the **Specify** list, choose **Coordinates**.
- 4 In the **z** text field, type -52[mm].
- 5 Locate the **Endpoint** section. From the **Specify** list, choose **Coordinates**.
- 6 In the **r** text field, type  $\text{sqrt}((115[\text{mm}])^2 - (52[\text{mm}])^2)$ .
- 7 In the **z** text field, type -52[mm].
- 8 Locate the **Selections of Resulting Entities** section. Select the **Resulting objects selection** check box.

#### *Union 2 (uni2)*

- 1 In the **Geometry** toolbar, click  **Booleans and Partitions** and choose **Union**.
- 2 Click in the **Graphics** window and then press Ctrl+A to select all objects.

#### *Delete Entities 2 (del2)*

- 1 Right-click **Geometry 1** and choose **Delete Entities**.
- 2 On the object **uni2**, select Boundaries 13, 19, 33, and 45 only.



#### *Fillet 1 (fil1)*

- 1 In the **Geometry** toolbar, click  **Fillet**.
- 2 On the object **del2**, select Points 14, 15, 35, and 36 only.
- 3 In the **Settings** window for **Fillet**, locate the **Radius** section.
- 4 In the **Radius** text field, type 0.2[mm].

#### *Form Union (fin)*

- 1 In the **Model Builder** window, click **Form Union (fin)**.
- 2 In the **Settings** window for **Form Union/Assembly**, locate the **Form Union/Assembly** section.
- 3 From the **Repair tolerance** list, choose **Relative**.

#### *Ignore Vertices 1 (igv1)*

- 1 In the **Geometry** toolbar, click  **Virtual Operations** and choose **Ignore Vertices**.
- 2 On the object **fin**, select Points 18, 26, and 33 only.
- 3 In the **Geometry** toolbar, click  **Build All**.