

Electric Motor Noise: Permanent Magnet Synchronous Motor

Introduction

Electric motors are ubiquitous in many different industries. Cars, white goods, heating, ventilation, and air conditioning (HVAC) systems require electric motors that not only have the right electromechanical characteristics, but also limit the noise generated during its operation. This model demonstrates how to analyze the noise generated by an electric motor during its operation at different speeds of rotation. The type of electric motor analyzed, a permanent magnet synchronous motor (PMSM) uses permanent magnets in the rotor and a variable frequency current traveling through the stator to generate torque.

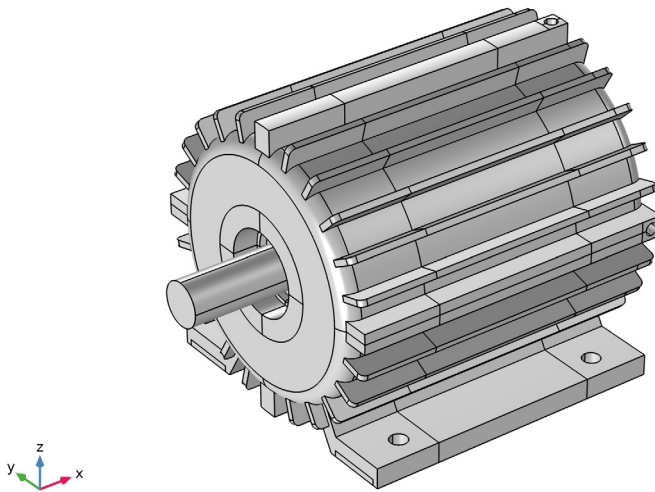

Figure 1: Geometry of the electric motor without the surrounding domains.

The geometry of the electric motor is shown in [Figure 1](#). The electromagnetic forces generated during its operation result in vibrations not only at the frequency of rotation of the rotor but also at higher frequencies or harmonics. A transient analysis is used to determine the electromagnetic forces in the time domain. A Fourier transform is used to determine the contributions in the frequency domain. The vibroacoustic response of the PMSM casing and its acoustic radiation is computed. A Campbell diagram is generated showing the main harmonics contributing to the acoustic response of the PMSM at various speeds of rotation.

Model Definition

The electromagnetic characteristics of a PMSM are typically well approximated by simulating a 2D section of the motor. In order to reduce the computational cost of the current analysis, the model uses this approximation and computes the electromagnetic forces using a 2D model. The section of the PMSM, shown in [Figure 2](#), is used to compute the transient electromagnetic forces developed during its rotation. This transient simulation covers a rotation of 60° . This is the minimum angle of rotation that brings back the geometry to an equivalent of the initial position, based on the number of poles and coils.

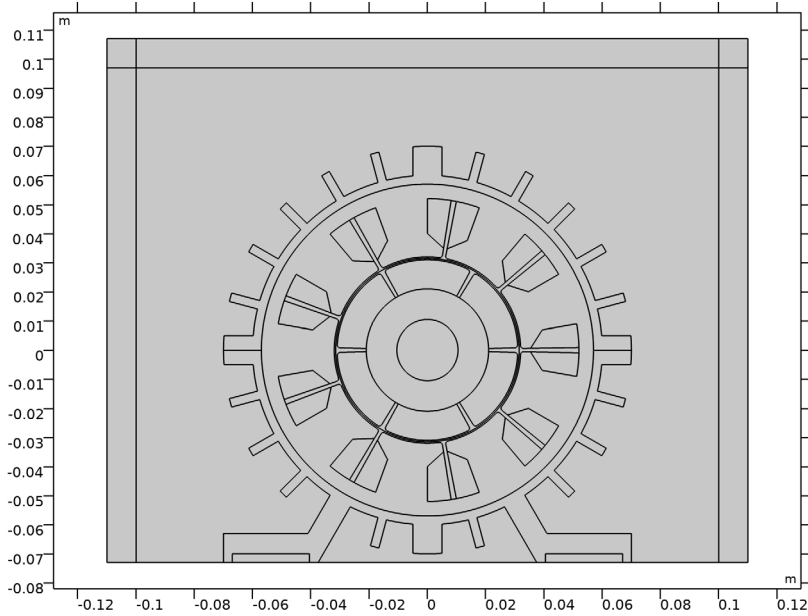

Figure 2: 2D section the electric motor with the surrounding air domains.

This analysis produces a spatial distribution of forces that are computed in the time domain and are transformed in the frequency domain by using the *Time to Frequency FFT Solver*. This solver performs a discrete Fourier transformation of a time-dependent variable and transforms it into a series of complex coefficients given by [Equation 1](#).

$$\omega(f_k) = \sum_{j=0}^{N-1} u(t_j) e^{\frac{2\pi i j k}{N}} \quad (1)$$

Where $\omega(f_k)$ is the complex Fourier coefficients for the frequency f_k , $u(t_j)$ is the input signal at the time t_j , i denotes the imaginary unit and N is the total number of samples of the input signal. For each frequency f_k , this transformation produces a spatial distribution of complex forces. The fact that these forces are complex valued means that the excitation includes both the force magnitude and its phase, so different parts of the model will be excited at different phases.

The frequency at which these electromagnetic forces are created is directly proportional to the speed of rotation of the rotor. As these forces produce an almost constant torque, the mechanical power generated by the motor is in fact proportional to the speed of rotation. This is usually true for small rotational speeds. The thermal losses in the coils are proportional to the mechanical power of the engine. As the rotational speed increases, these losses become substantial and the passive cooling is not able to keep up. This is what is called the thermal limit of the motor. Most motors control the torque-speed curve to avoid reaching the thermal limit. This curve usually keeps a constant torque for low rotational speeds and then a constant power at higher speeds. The model uses the torque-speed curve shown on [Figure 3](#), but any other curve could be used instead.

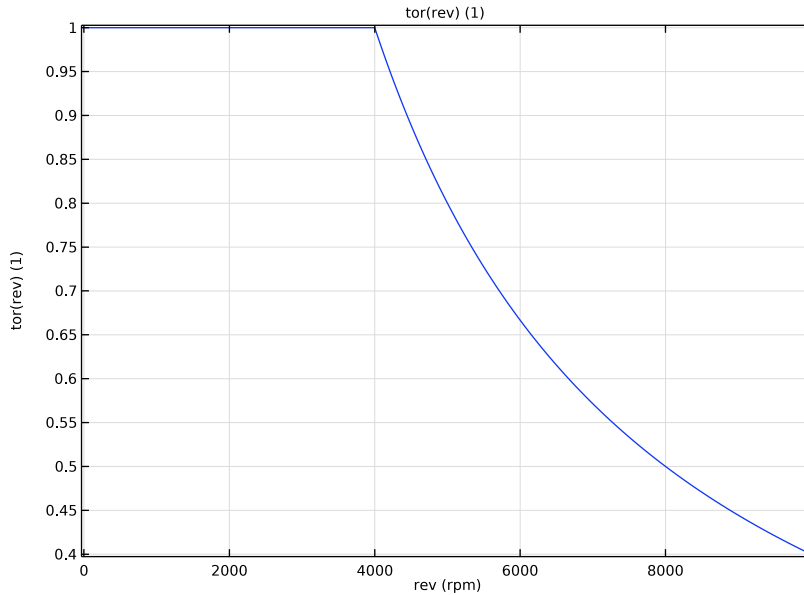

Figure 3: Torque-Speed of rotation curve.

The electromagnetic forces generated at different multiples of the rotor speed are called harmonics. Each of these harmonics will have a different contribution to the total noise at various driving frequencies. In the following step, the 2D harmonic forces are applied to the 3D model of the electric engine with the acoustic domains surrounding the motor. [Figure 4](#) shows the 3D geometry including the surrounding acoustic domains.

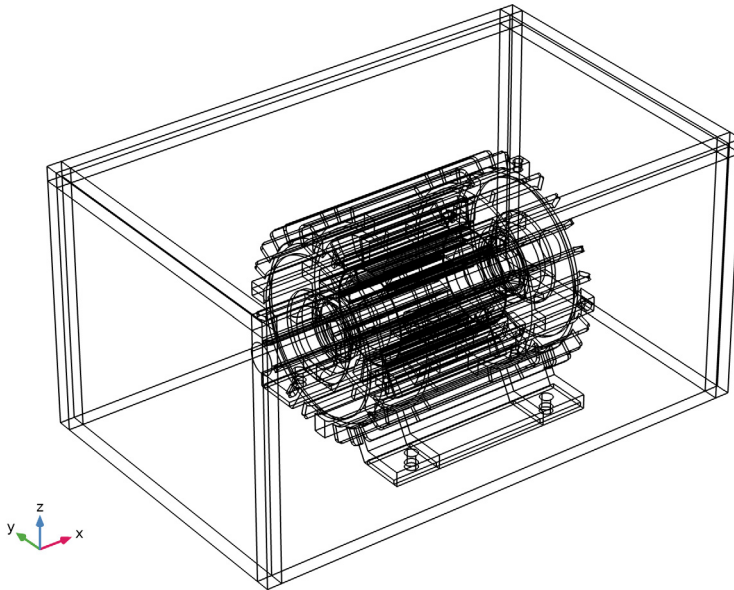

Figure 4: 3D geometry including the acoustic domains representing an open domain.

Once the frequency response to each of the harmonic excitation is known, it is possible to create a Campbell diagram, sometimes called Waterfall plot. The Campbell diagram shows, for a given location, the contribution of the different harmonics to the total noise level as a function of the rotational speed. This allows the identification of undesirable characteristics like frequencies where the casing is very efficient at radiating noise or harmonics which are dominant in the total noise.

Another method to present these results is to generate a time signal of the acoustic response at a given point as the rotational speed of the motor varies. [Figure 5](#) shows the variation of the rotational speed during the duration of the acoustic signal used to generate the time signal. Any other duration of the time signal or variation profile of the rotational speed could be used.

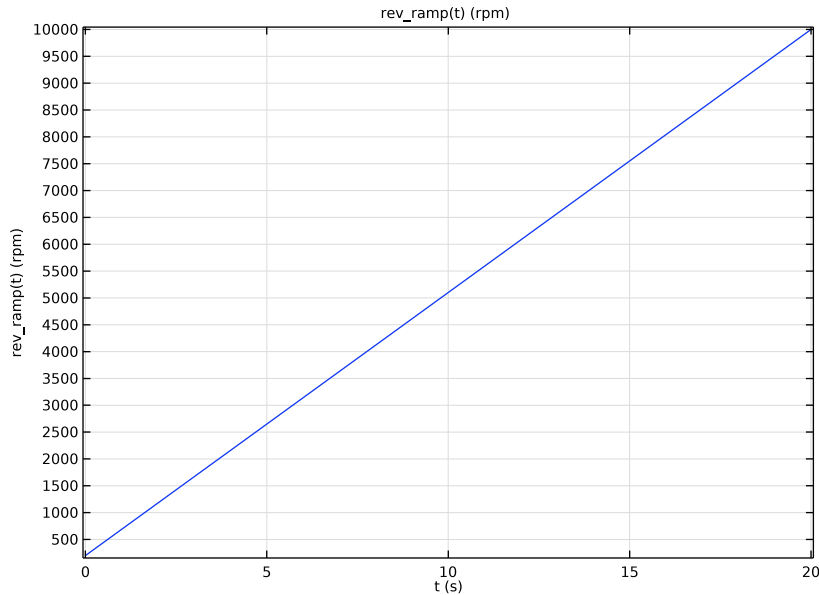

Figure 5: Variation of the motor rotational speed during the duration of the acoustic signal.

This model presents a quick and efficient method to analyze the harmonic content of the sound generated by a PMSM. Other acoustic sources like the gear noise or the wind induced noise due to the refrigeration are not considered. Due to the limited frequency content of the harmonic noise, it is usually the noise that stands out in an electric motor and thus the main source that is tuned during the design of an electric motor.

Results and Discussion

Figure 6 shows the magnetic flux density norm and streamlines at four different times of the time dependent step. Note the rotation of the rotor and how the magnetic flux is concentrated in the areas close to the magnets and in the outer part of the coils.

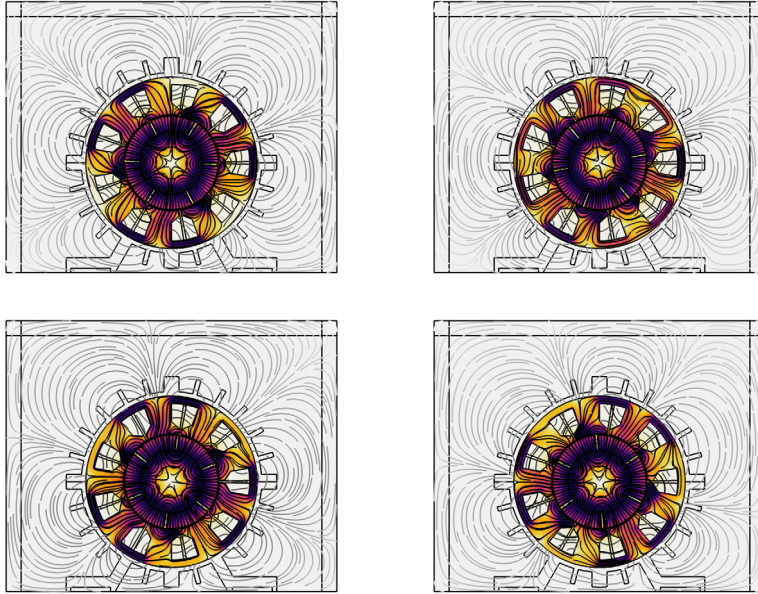

Figure 6: Magnetic flux density norm and streamlines at 0 ms, 10 ms, 20 ms, and 30 ms.

The time-domain analysis produces a distribution of forces in the stator and rotor. As an example of the time variation of these forces, [Figure 7](#) shows the components of the electromagnetic forces for two points in the model. This time signal is a periodic signal that will be repeated 6 times during a complete rotation of the rotor.

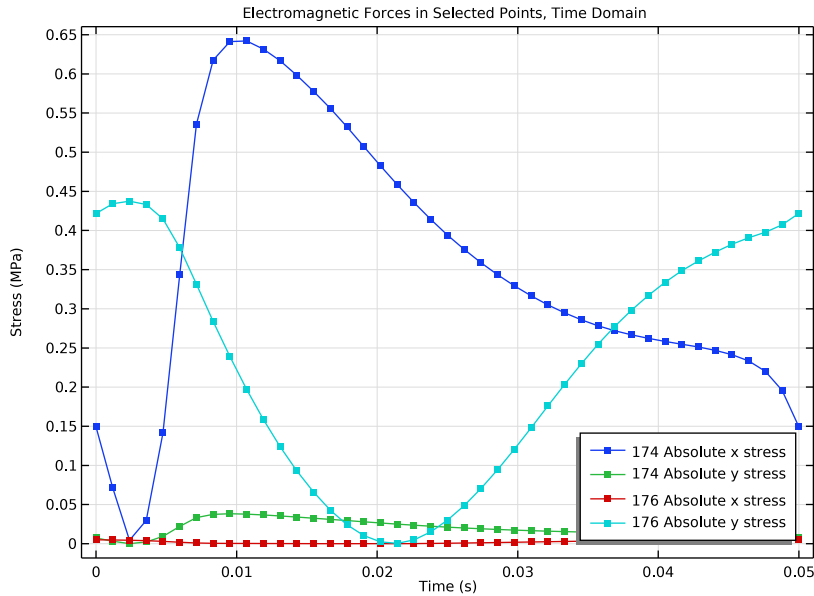

Figure 7: Time domain signal of the components of the electromagnetic forces at two points.

This time signal can be easily transformed into the frequency domain and normalized to the value of the first harmonic. Figure 8 shows how the FFT of the forces normalized to the first harmonic at 20 Hz, has decreasing values as the frequency increases. The eighth harmonic has a contribution that is below 5% of the first harmonic, so considering seven harmonics in the analysis seems reasonable, as any higher order harmonics are likely to have very limited influence.

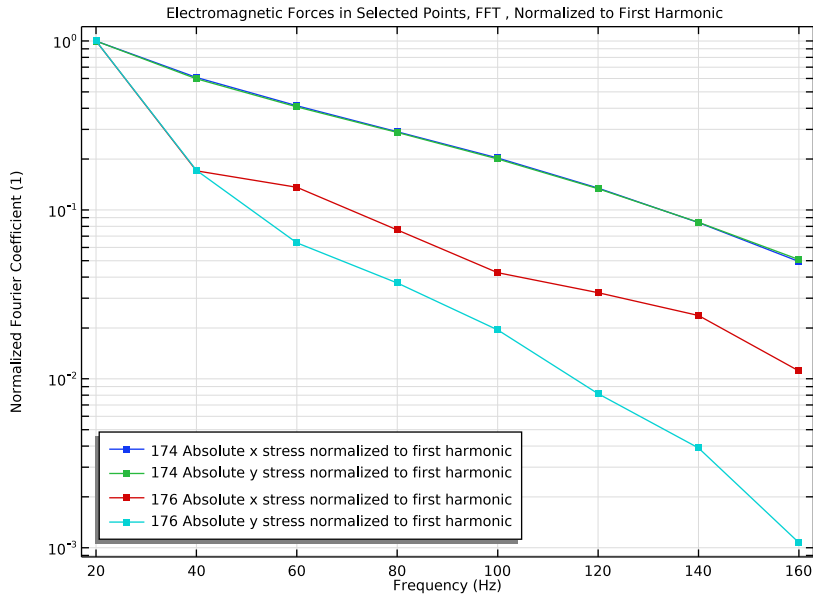

Figure 8: Frequency domain components of the electromagnetic forces at two points, normalized to the first harmonic value.

It is also relevant to analyze the spatial distribution of the different harmonics, not only its variation with frequency for a single point. [Figure 9](#) shows the spatial distribution of the seventh harmonic, the last harmonic solved for. Harmonics above this one will require a finer mesh, as the higher the harmonic, the finer the spatial distribution of the electromagnetic forces. In order to solve harmonics above the seventh, the model would need to have a finer mesh, which would increase the computational time and will not add substantial contributions to the noise.

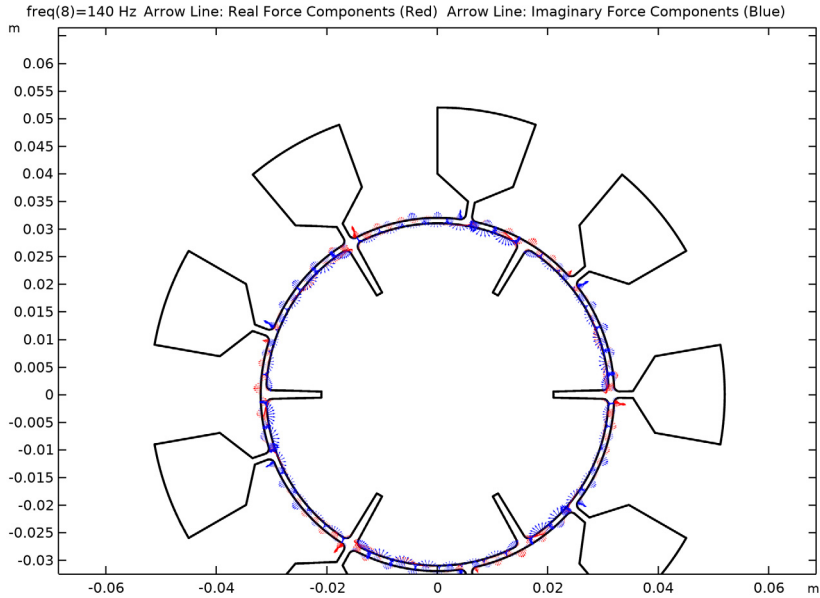

Figure 9: Spatial distribution of the electromagnetic forces in the frequency domain, showing both real (red arrows) and imaginary (blue arrows) parts.

The electromagnetic forces obtained in the 2D model can be translated to the 3D model using the *General Extrusion* feature. [Figure 10](#) shows the 3D model and the forces generated by the third harmonic.

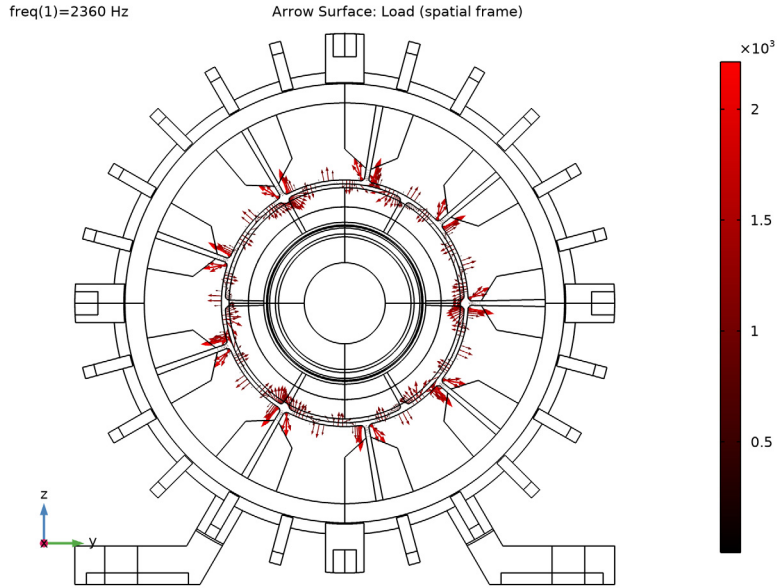

Figure 10: Real part of the electromagnetic forces applied to the 3D model for the third harmonic.

This forces, although compensated globally due to the symmetry of the motor, produce displacements in the structure that in turn are converted to acoustic pressure.

[Figure 11](#) shows the displacement and acoustic pressure generated by the third harmonic at 2,360 Hz.

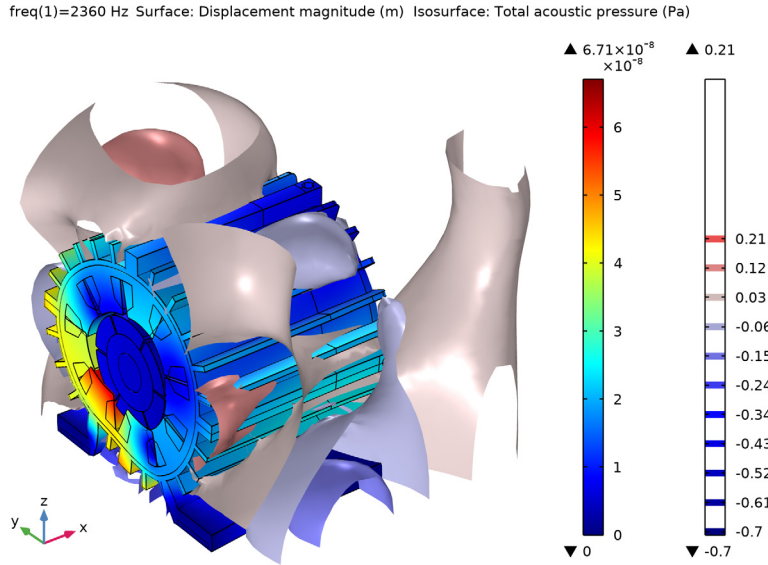

Figure 11: Displacements and acoustic pressures generated by the third harmonic at 2,360 Hz.

The *Exterior Field* feature permits the evaluation of the acoustic pressure at any point outside of the computational domain. [Figure 12](#) shows the sound pressure level (SPL) at the surface of the motor and at 0.5 m away from the motor. Note how this radiation pattern has many lobes, meaning that the acoustic response will depend greatly on the position of the listening point.

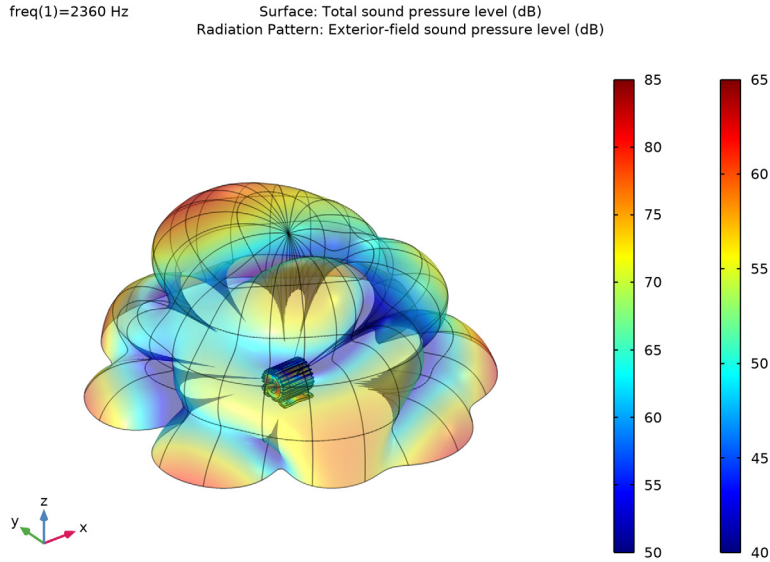

Figure 12: Sound pressure level at the surface of the motor and 0.5 m away.

The contribution of the different harmonics can be seen in a Campbell diagram. A Campbell diagram shows, for a given listening point, the sound pressure level of each harmonic as a function of the speed of rotation of the motor. [Figure 13](#) shows how the two microphones present very different Campbell diagrams. Note how the first and third harmonics have the largest influence on the noise level for both microphone positions. Note as well how the first microphone shows increased noise levels around 2,500 Hz for most of the harmonics, indicating that there is a casing mode making this frequency stand out. A similar effect is found for the second microphone slightly below 2,500 Hz and around 1800 Hz.

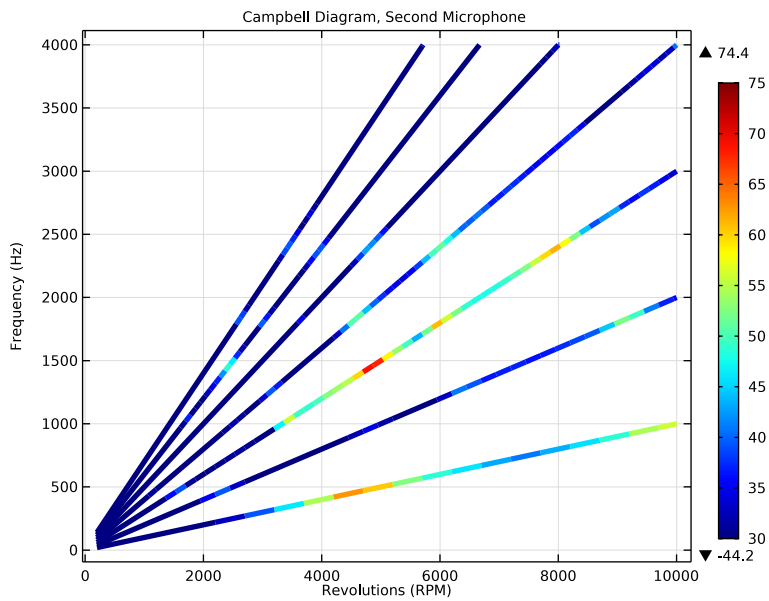
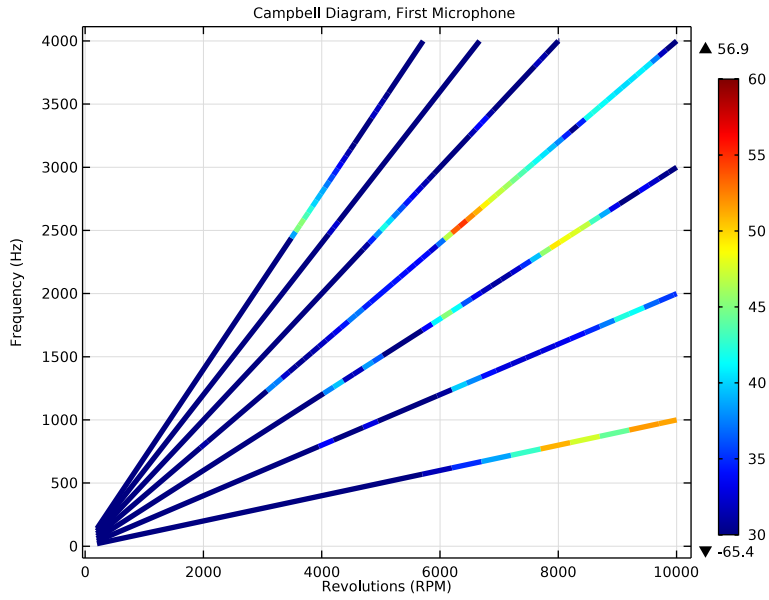

Figure 13: Campbell diagrams at the microphones.

Notes About the COMSOL Implementation

The electromagnetic model contains two different objects forming an assembly. Having independent meshes in each of the objects permits the rotation of the rotor using the *Rotating Domain* feature.

The electromagnetic analysis study composes two steps, a stationary analysis and a time dependent analysis. The stationary analysis is used to initialize the electromagnetic field as the system contains permanent magnets and nonzero currents at the initial time. Trying to solve the time dependent analysis without the stationary part assumes that the currents are switched on and the magnets added at first time step. This will make the convergence almost impossible. Turning the Jacobian update to every iteration on the time dependent analysis reduces the total running time.

The electromagnetic forces are computed through the use of the *Force Calculation* feature available in the *Magnetic Fields* physics. A Weak Form Boundary PDE is used to store the electromagnetic forces at the interfaces and produce a FFT only of this forces, instead of the complete solution.

The Time to Frequency FFT study is used to transform a spatial and time dependent variable into a complex variable in the frequency domain. Once that the electromagnetic forces are expressed in the frequency domain, it is simpler to produce frequency response analysis for a varying excitation.

The *General Extrusion* feature is used to transform variables existing in a component to another component with different coordinates or even different number of dimensions. In this case, the 2D results are translated to the 3D component using the `comp.genext()` operator.

The operator `withsol()` is used to select the right harmonic of the excitation forces in the frequency sweep. As an example, the expression, `withsol('sol3',Fy,setval(freq,20[Hz]*(harm_exc)))`, takes the variable `Fy` from the `sol3` (The results of the FFT) with the frequency matching 20 Hz times the number of the harmonic excited.

The frequency request in the vibroacoustic analysis uses the expression `range(f0*harm_exc,fdelta,min(fmax,rpm_max/rpm0*f0*harm_exc) min(fmax,rpm_max/rpm0*f0*harm_exc))` which is a frequency sweep starting at `f0` times the number of the harmonic excited, taking steps every `fdelta` and stopping when the rotational speed reaches 10,000 rpm or the frequency reaches 4,000 Hz, whatever happens first.

The solver in the vibroacoustic analysis is set manually to a segregated solver with 1 iteration, meaning that the displacements will be obtained first and the acoustic pressure

will be computed based on these displacements, without back coupling of the acoustic pressure into the structural problem. This is an adequate approach for problems where vibrating structures radiate noise into the environment, and allows for a reduction in the running times. This assumption should always be confirmed with a fully coupled analysis.

The model takes approximately 8 hours to run on a workstation with a sweep of 7 harmonics and outputs every 50 Hz. This run time can be significantly reduced by using distributed cluster computation or reducing the number of frequencies or harmonics requested.

The acoustic signal is exported to a .wav file that could be listened to or postprocess with any other tool.

Application Library path: Acoustics_Module/Automotive/
electric_motor_noise_pmsm



Modeling Instructions

From the **File** menu, choose **New**.

NEW

In the **New** window, click  **Model Wizard**.

MODEL WIZARD

- 1 In the **Model Wizard** window, click  **2D**.
- 2 In the **Select Physics** tree, select **AC/DC>Electromagnetic Fields>Magnetic Fields (mf)**.
- 3 Click **Add**.
- 4 In the **Select Physics** tree, select **Mathematics>PDE Interfaces>Lower Dimensions>Weak Form Boundary PDE (wb)**.
- 5 Click **Add**.
- 6 Click  **Study**.
- 7 In the **Select Study** tree, select **General Studies>Stationary**.
- 8 Click  **Done**.





ROOT

The first study uses the cross section of the electric engine to compute the electromagnetic excitation. Proceed to add a 3D component and import the geometry of the engine.

ADD COMPONENT

In the **Home** toolbar, click  **Add Component** and choose **3D**.

GEOMETRY 2

- 1 In the **Geometry** toolbar, click  **Insert Sequence**.
- 2 Browse to the model's Application Libraries folder and double-click the file `electric_motor_noise_pmsm_geom_sequence.mph`.
- 3 In the **Geometry** toolbar, click  **Build All**.
- 4 Click the  **Wireframe Rendering** button in the **Graphics** toolbar.
- 5 Click the  **Show Grid** button in the **Graphics** toolbar.

Wireframe rendering allows for an easier visualization of the geometry. The geometry should look like [Figure 4](#).

The imported COMSOL file includes a set of parameters which facilitate the update of the electric engine. Update the name of the parameter group.



GLOBAL DEFINITIONS

Geometry parameters

- 1 In the **Model Builder** window, under **Global Definitions** click **Parameters 1**.
- 2 In the **Settings** window for **Parameters**, type `Geometry parameters` in the **Label** text field.

Add a new parameter group and populate this group with the parameters imported from an external file. This second parameter group includes parameter related to the modeling.

Model Parameters

- 1 In the **Home** toolbar, click  **Parameters** and choose **Add>Parameters**.
- 2 In the **Settings** window for **Parameters**, type `Model Parameters` in the **Label** text field.
- 3 Locate the **Parameters** section. Click  **Load from File**.
- 4 Browse to the model's Application Libraries folder and double-click the file `electric_motor_noise_pmsm_parameters.txt`.

Add a **Cross Section** feature to generate the 2D geometry. As the rotor will be rotating through a **Rotating Domain** feature, it is necessary that the 2D geometry is created as an assembly.

GEOMETRY I

In the **Model Builder** window, under **Component 1 (comp1)** click **Geometry 1**.

Cross Section 1 (crol)

- 1 In the **Geometry** toolbar, click  **Cross Section**.
- 2 In the **Settings** window for **Cross Section**, click  **Build Selected**.

Form Union (fin)

- 1 In the **Model Builder** window, under **Component 1 (comp1)**>**Geometry 1** click **Form Union (fin)**.
- 2 In the **Settings** window for **Form Union/Assembly**, locate the **Form Union/Assembly** section.
- 3 From the **Action** list, choose **Form an assembly**.
- 4 In the **Geometry** toolbar, click  **Build All**.

The geometry should look like [Figure 2](#).

Now proceed to create some selections that will be used during the model definition.

DEFINITIONS (COMP1)

Shaft

- 1 In the **Definitions** toolbar, click  **Explicit**.
- 2 In the **Settings** window for **Explicit**, type Shaft in the **Label** text field.
- 3 Select Domain 40 only.

Laminated rotor

- 1 In the **Definitions** toolbar, click  **Explicit**.
- 2 In the **Settings** window for **Explicit**, type Laminated rotor in the **Label** text field.
- 3 Select Domain 39 only.

Magnets A

- 1 In the **Definitions** toolbar, click  **Explicit**.
- 2 In the **Settings** window for **Explicit**, type Magnets A in the **Label** text field.
- 3 Select Domains 33, 36, and 37 only.

Magnets B

- 1 In the **Definitions** toolbar, click  **Explicit**.
- 2 In the **Settings** window for **Explicit**, type Magnets B in the **Label** text field.
- 3 Select Domains 34, 35, and 38 only.

Magnets

- 1 In the **Definitions** toolbar, click  **Union**.
- 2 In the **Settings** window for **Union**, type Magnets in the **Label** text field.
- 3 Locate the **Input Entities** section. Under **Selections to add**, click **+ Add**.
- 4 In the **Add** dialog box, in the **Selections to add** list, choose **Magnets A** and **Magnets B**.
- 5 Click **OK**.

Inner air gap

- 1 In the **Definitions** toolbar, click  **Explicit**.
- 2 In the **Settings** window for **Explicit**, type Inner air gap in the **Label** text field.
- 3 Select Domain 32 only.

Rotor

- 1 In the **Definitions** toolbar, click  **Union**.
- 2 In the **Settings** window for **Union**, type Rotor in the **Label** text field.
- 3 Locate the **Input Entities** section. Under **Selections to add**, click **+ Add**.
- 4 In the **Add** dialog box, in the **Selections to add** list, choose **Shaft**, **Laminated rotor**, and **Magnets**.
- 5 Click **OK**.

Rotating parts

- 1 In the **Definitions** toolbar, click  **Union**.
- 2 In the **Settings** window for **Union**, type Rotating parts in the **Label** text field.
- 3 Locate the **Input Entities** section. Under **Selections to add**, click **+ Add**.
- 4 In the **Add** dialog box, in the **Selections to add** list, choose **Inner air gap** and **Rotor**.
- 5 Click **OK**.

Fixed Parts

- 1 In the **Definitions** toolbar, click  **Complement**.
- 2 In the **Settings** window for **Complement**, type Fixed Parts in the **Label** text field.
- 3 Locate the **Input Entities** section. Under **Selections to invert**, click **+ Add**.

- 4 In the **Add** dialog box, select **Rotating parts** in the **Selections to invert** list.
- 5 Click **OK**.

Coils A

- 1 In the **Definitions** toolbar, click  **Explicit**.
- 2 In the **Settings** window for **Explicit**, type Coils A in the **Label** text field.
- 3 Select Domains 12, 15, 18, 20, 25, and 27 only.



Coils B

- 1 In the **Definitions** toolbar, click  **Explicit**.
- 2 In the **Settings** window for **Explicit**, type Coils B in the **Label** text field.
- 3 Select Domains 13, 16, 17, 19, 26, and 28 only.

Coils C

- 1 In the **Definitions** toolbar, click  **Explicit**.
- 2 In the **Settings** window for **Explicit**, type Coils C in the **Label** text field.
- 3 Select Domains 9, 10, and 21–24 only.

Coils

- 1 In the **Definitions** toolbar, click  **Union**.
- 2 In the **Settings** window for **Union**, type Coils in the **Label** text field.
- 3 Locate the **Input Entities** section. Under **Selections to add**, click  **Add**.
- 4 In the **Add** dialog box, in the **Selections to add** list, choose **Coils A**, **Coils B**, and **Coils C**.
- 5 Click **OK**.

Outer air gap

- 1 In the **Definitions** toolbar, click  **Explicit**.
- 2 In the **Settings** window for **Explicit**, type Outer air gap in the **Label** text field.
- 3 Select Domain 11 only.

Exterior air

- 1 In the **Definitions** toolbar, click  **Explicit**.
- 2 In the **Settings** window for **Explicit**, type Exterior air in the **Label** text field.
- 3 Select Domains 1–4, 14, 30, and 31 only.

Casing

- 1 In the **Definitions** toolbar, click  **Explicit**.
- 2 In the **Settings** window for **Explicit**, type Casing in the **Label** text field.

3 Select Domains 5–7 and 29 only.

Air

- 1 In the **Definitions** toolbar, click  **Union**.
- 2 In the **Settings** window for **Union**, type Air in the **Label** text field.
- 3 Locate the **Input Entities** section. Under **Selections to add**, click **+ Add**.
- 4 In the **Add** dialog box, in the **Selections to add** list, choose **Inner air gap**, **Outer air gap**, and **Exterior air**.
- 5 Click **OK**.

Stator forces

- 1 In the **Definitions** toolbar, click  **Difference**.
- 2 In the **Settings** window for **Difference**, type Stator forces in the **Label** text field.
- 3 Locate the **Input Entities** section. Under **Selections to add**, click **+ Add**.
- 4 In the **Add** dialog box, select **Fixed Parts** in the **Selections to add** list.
- 5 Click **OK**.
- 6 In the **Settings** window for **Difference**, locate the **Input Entities** section.
- 7 Under **Selections to subtract**, click **+ Add**.
- 8 In the **Add** dialog box, in the **Selections to subtract** list, choose **Coils**, **Casing**, and **Air**.
- 9 Click **OK**.

External boundaries

- 1 In the **Model Builder** window, right-click **Selections** and choose **Disk**.
- 2 In the **Settings** window for **Disk**, type External boundaries in the **Label** text field.
- 3 Locate the **Geometric Entity Level** section. From the **Level** list, choose **Boundary**.
- 4 Locate the **Size and Shape** section. In the **Outer radius** text field, type inf.
- 5 In the **Inner radius** text field, type r_stator.

Adjacent to rotor forces

- 1 In the **Definitions** toolbar, click  **Adjacent**.
- 2 In the **Settings** window for **Adjacent**, type Adjacent to rotor forces in the **Label** text field.
- 3 Locate the **Input Entities** section. Under **Input selections**, click **+ Add**.
- 4 In the **Add** dialog box, select **Rotor** in the **Input selections** list.
- 5 Click **OK**.

Adjacent to stator forces

- 1 In the **Definitions** toolbar, click  **Adjacent**.
- 2 In the **Settings** window for **Adjacent**, type Adjacent to stator forces in the **Label** text field.
- 3 Locate the **Input Entities** section. Under **Input selections**, click **+ Add**.
- 4 In the **Add** dialog box, select **Stator forces** in the **Input selections** list.
- 5 Click **OK**.

Force calculation

- 1 In the **Definitions** toolbar, click  **Difference**.
- 2 In the **Settings** window for **Difference**, type Force calculation in the **Label** text field.
- 3 Locate the **Geometric Entity Level** section. From the **Level** list, choose **Boundary**.
- 4 Locate the **Input Entities** section. Under **Selections to add**, click **+ Add**.
- 5 In the **Add** dialog box, in the **Selections to add** list, choose **Adjacent to rotor forces** and **Adjacent to stator forces**.
- 6 Click **OK**.
- 7 In the **Settings** window for **Difference**, locate the **Input Entities** section.
- 8 Under **Selections to subtract**, click **+ Add**.
- 9 In the **Add** dialog box, select **External boundaries** in the **Selections to subtract** list.
- 10 Click **OK**.

Adjacent to air gaps and coils

- 1 In the **Definitions** toolbar, click  **Adjacent**.
- 2 In the **Settings** window for **Adjacent**, type Adjacent to air gaps and coils in the **Label** text field.
- 3 Locate the **Input Entities** section. Under **Input selections**, click **+ Add**.
- 4 In the **Add** dialog box, in the **Input selections** list, choose **Inner air gap**, **Coils**, and **Outer air gap**.
- 5 Click **OK**.

Iron

- 1 In the **Definitions** toolbar, click  **Union**.
- 2 In the **Settings** window for **Union**, type Iron in the **Label** text field.
- 3 Locate the **Input Entities** section. Under **Selections to add**, click **+ Add**.

4 In the **Add** dialog box, in the **Selections to add** list, choose **Shaft**, **Laminated rotor**, and **Stator forces**.

5 Click **OK**.

Force calculation domains

1 In the **Definitions** toolbar, click  **Union**.

2 In the **Settings** window for **Union**, type Force calculation domains in the **Label** text field.

3 Locate the **Input Entities** section. Under **Selections to add**, click **+ Add**.

4 In the **Add** dialog box, in the **Selections to add** list, choose **Inner air gap**, **Coils**, and **Outer air gap**.

5 Click **OK**.

Adjacent to air gap in the stator

1 In the **Definitions** toolbar, click  **Difference**.

2 In the **Settings** window for **Difference**, type Adjacent to air gap in the stator in the **Label** text field.

3 Locate the **Geometric Entity Level** section. From the **Level** list, choose **Boundary**.

4 Locate the **Input Entities** section. Under **Selections to add**, click **+ Add**.

5 In the **Add** dialog box, select **Adjacent to stator forces** in the **Selections to add** list.

6 Click **OK**.

7 In the **Settings** window for **Difference**, locate the **Input Entities** section.

8 Under **Selections to subtract**, click **+ Add**.

9 In the **Add** dialog box, select **External boundaries** in the **Selections to subtract** list.

10 Click **OK**.

Add a variable that will define the rotation both in a stationary and a time dependent step.

Variables 1

1 In the **Model Builder** window, right-click **Definitions** and choose **Variables**.

2 In the **Settings** window for **Variables**, locate the **Variables** section.

3 In the table, enter the following settings:

Name	Expression	Unit	Description
rotation	$\text{if}(\text{isdefined}(t), w_0 * t + \text{ang}0, 0)$	rad	Rotation

The **General Extrusion** coupling operator to map the 2D results into the 3D geometry. This operator allows to map geometries even when the coordinate axes are not alligned.

General Extrusion 1 (genext1)

- 1 In the **Definitions** toolbar, click  **Nonlocal Couplings** and choose **General Extrusion**.
- 2 In the **Settings** window for **General Extrusion**, locate the **Source Selection** section.
- 3 From the **Geometric entity level** list, choose **Boundary**.
- 4 From the **Selection** list, choose **Force calculation**.
- 5 Locate the **Destination Map** section. In the **x-expression** text field, type *y*.
- 6 In the **y-expression** text field, type *z*.
- 7 Locate the **Source** section. Select the **Use source map** check box.
- 8 Click to expand the **Advanced** section. From the **Mesh search method** list, choose **Closest point**.
- 9 Select the **Use NaN when mapping fails** check box.

Add a **Cylindrical System** that will be used to define the orientation of the magnets.

Cylindrical System 3 (sys3)

In the **Definitions** toolbar, click  **Coordinate Systems** and choose **Cylindrical System**.

The **Rotating Domain** allows for the rotor to move independently of the stator.

Rotating Domain 1

- 1 In the **Definitions** toolbar, click  **Moving Mesh** and choose **Rotating Domain**.
- 2 In the **Settings** window for **Rotating Domain**, locate the **Domain Selection** section.
- 3 From the **Selection** list, choose **Rotating parts**.
- 4 Locate the **Rotation** section. In the α text field, type *rotation*.

In the next steps, add the materials that make the section of the engine.

MATERIALS

Non-magnetic parts

- 1 In the **Model Builder** window, under **Component 1 (comp1)** right-click **Materials** and choose **Blank Material**.
- 2 In the **Settings** window for **Material**, type *Non-magnetic parts* in the **Label** text field. Populate the missing properties of the material.

3 Locate the **Material Contents** section. In the table, enter the following settings:

Property	Variable	Value	Unit	Property group
Relative permeability	mur_iso ; murii = mur_iso, murij = 0	1		Basic
Electrical conductivity	sigma_iso ; sigmai = sigma_iso, sigmaj = 0	0	S/m	Basic
Relative permittivity	epsilon_r_iso ; epsilon_rii = epsilon_r_iso, epsilon_rij = 0	1		Basic

4 In the **Home** toolbar, click  **Windows** and choose **Add Material from Library**.

ADD MATERIAL

- 1 Go to the **Add Material** window.
- 2 In the tree, select **AC/DC>Soft Iron (Without Losses)**.
- 3 Click **Add to Component** in the window toolbar.

MATERIALS

Soft Iron (Without Losses) (mat2)

- 1 In the **Settings** window for **Material**, locate the **Geometric Entity Selection** section.
- 2 From the **Selection** list, choose **Iron**.

Add a relative permeability of 1 to the material.

3 Locate the **Material Contents** section. In the table, enter the following settings:

Property	Variable	Value	Unit	Property group
Relative permeability	mur_iso ; murii = mur_iso, murij = 0	1		Basic
Electrical conductivity	sigma_iso ; sigmai = sigma_iso, sigmaj = 0	0 [S/m]	S/m	Basic

Property	Variable	Value	Unit	Property group
Relative permittivity	epsilon _{r_iso} ; epsilon _{r_ii} = epsilon _{r_iso} , epsilon _{r_ij} = 0	1	I	Basic
Magnetic flux density norm	normB	BH(normHin)	T	B-H curve
Magnetic field norm	normH	BH_inv(normBin)	A/m	B-H curve
Magnetic coenergy density	Wpm	BH_prim(normHin)	J/m ³	B-H curve
Effective magnetic flux density norm	normBeff	BHeff(normHeffin)	T	Effective B-H curve
Effective magnetic field norm	normHeff	BHeff_inv(normBeffin)	A/m	Effective B-H curve

ADD MATERIAL

- 1 Go to the **Add Material** window.
- 2 In the tree, select **AC/DC>Copper**.
- 3 Click **Add to Component** in the window toolbar.

MATERIALS

Copper (mat3)

- 1 In the **Settings** window for **Material**, locate the **Geometric Entity Selection** section.
- 2 From the **Selection** list, choose **Coils**.

ADD MATERIAL

- 1 Go to the **Add Material** window.
- 2 In the tree, select **AC/DC>Hard Magnetic Materials>Sintered NdFeB Grades (Chinese Standard)>N40 (Sintered NdFeB)**.
- 3 Click **Add to Component** in the window toolbar.
- 4 In the tree, select **Built-in>Aluminum 6063-T83**.
- 5 Click **Add to Component** in the window toolbar.
- 6 In the **Home** toolbar, click  **Add Material** to close the **Add Material** window.

MATERIALS

N40 (Sintered NdFeB) (mat4)

- 1 In the **Model Builder** window, under **Component 1 (comp1)>Materials** click **N40 (Sintered NdFeB) (mat4)**.
- 2 In the **Settings** window for **Material**, locate the **Geometric Entity Selection** section.
- 3 From the **Selection** list, choose **Magnets**.

Aluminum 6063-T83 (mat5)

- 1 In the **Model Builder** window, click **Aluminum 6063-T83 (mat5)**.
- 2 In the **Settings** window for **Material**, locate the **Geometric Entity Selection** section.
- 3 From the **Selection** list, choose **Casing**.

MAGNETIC FIELDS (MF)

Specify the length of the engine.

- 1 In the **Model Builder** window, under **Component 1 (comp1)** click **Magnetic Fields (mf)**.
- 2 In the **Settings** window for **Magnetic Fields**, locate the **Thickness** section.
- 3 In the d text field, type L_{transv} .
Use linear discretization to reduce the computation time.
- 4 Click to expand the **Discretization** section. From the **Magnetic vector potential** list, choose **Linear**.

Non magnetic domains

- 1 In the **Model Builder** window, under **Component 1 (comp1)>Magnetic Fields (mf)** click **Ampère's Law 1**.
- 2 In the **Settings** window for **Ampère's Law**, type **Non magnetic domains** in the **Label** text field.
As part of these domains will be rotating, it is necessary to change the material type to solid.
- 3 Locate the **Material Type** section. From the **Material type** list, choose **Solid**.

Iron domains

- 1 In the **Physics** toolbar, click  **Domains** and choose **Ampère's Law**.
- 2 In the **Settings** window for **Ampère's Law**, type **Iron domains** in the **Label** text field.
- 3 Locate the **Domain Selection** section. From the **Selection** list, choose **Iron**.
As the rotor is partially composed of iron parts, it is necessary to change the material type to solid.

- 4 Locate the **Material Type** section. From the **Material type** list, choose **Solid**.
- 5 Locate the **Constitutive Relation B-H** section. From the **Magnetization model** list, choose **B-H curve**.

Magnets A

- 1 In the **Physics** toolbar, click  **Domains** and choose **Ampère's Law**.
- 2 In the **Settings** window for **Ampère's Law**, type Magnets A in the **Label** text field.
- 3 Locate the **Domain Selection** section. From the **Selection** list, choose **Magnets A**.
- 4 Locate the **Material Type** section. From the **Material type** list, choose **Solid**.
The magnets are oriented along the tangent direction of the rotor.
- 5 Locate the **Coordinate System Selection** section. From the **Coordinate system** list, choose **Cylindrical System 3 (sys3)**.
- 6 Locate the **Constitutive Relation B-H** section. From the **Magnetization model** list, choose **Remanent flux density**.
- 7 Locate the **Constitutive Relation Jc-E** section. From the σ list, choose **User defined**.

Magnets B

- 1 Right-click **Magnets A** and choose **Duplicate**.
- 2 In the **Settings** window for **Ampère's Law**, type Magnets B in the **Label** text field.
- 3 Locate the **Domain Selection** section. From the **Selection** list, choose **Magnets B**.
- 4 Locate the **Constitutive Relation B-H** section. Specify the **e** vector as

-1	r
0	phi
0	a

Proceed to define the engine coil groups.

Coils A

- 1 In the **Physics** toolbar, click  **Domains** and choose **Coil**.
- 2 In the **Settings** window for **Coil**, type Coils A in the **Label** text field.
- 3 Locate the **Domain Selection** section. From the **Selection** list, choose **Coils A**.
- 4 Locate the **Material Type** section. From the **Material type** list, choose **Solid**.
- 5 Locate the **Coil** section. From the **Conductor model** list, choose **Homogenized multiturn**.
- 6 Select the **Coil group** check box.
- 7 In the I_{coil} text field, type $I0*\cos(3*rotation)$.

- 8 Locate the **Homogenized Multiturn Conductor** section. In the N text field, type Ncoil.
- 9 In the a_{coil} text field, type a_coil.

Add a **Reversed Current Direction** feature to represent the part of the coil with current travelling in the opposing direction.

Reversed Current Direction I

- 1 In the **Physics** toolbar, click  **Attributes** and choose **Reversed Current Direction**.
- 2 Select Domains 15, 18, and 27 only.

Coils B

- 1 In the **Model Builder** window, right-click **Coils A** and choose **Duplicate**.
- 2 In the **Settings** window for **Coil**, type Coils B in the **Label** text field.
- 3 Locate the **Domain Selection** section. From the **Selection** list, choose **Coils B**.
- 4 Locate the **Coil** section. In the I_{coil} text field, type $I0*\cos(3*\text{rotation}-120[\text{deg}])$.

Reversed Current Direction I

- 1 In the **Model Builder** window, expand the **Coils B** node, then click **Reversed Current Direction I**.
- 2 In the **Settings** window for **Reversed Current Direction**, locate the **Domain Selection** section.
- 3 Click  **Clear Selection**.
- 4 Select Domains 13, 19, and 26 only.

Coils C



- 1 In the **Model Builder** window, right-click **Coils B** and choose **Duplicate**.
- 2 In the **Settings** window for **Coil**, type Coils C in the **Label** text field.
- 3 Locate the **Domain Selection** section. From the **Selection** list, choose **Coils C**.
- 4 Locate the **Coil** section. In the I_{coil} text field, type $I0*\cos(3*\text{rotation}-240[\text{deg}])$.

Reversed Current Direction I

- 1 In the **Model Builder** window, expand the **Coils C** node, then click **Reversed Current Direction I**.
- 2 In the **Settings** window for **Reversed Current Direction**, locate the **Domain Selection** section.
- 3 Click  **Clear Selection**.
- 4 Select Domains 9, 22, and 23 only.

Add a **Continuity** feature to make sure that the electromagnetic fields are continuous through the identity pair.

Continuity 1

- 1 In the **Physics** toolbar, click  **Pairs** and choose **Continuity**.
- 2 In the **Settings** window for **Continuity**, locate the **Pair Selection** section.
- 3 Under **Pairs**, click  **Add**.
- 4 In the **Add** dialog box, select **Identity Boundary Pair 2 (ap2)** in the **Pairs** list.
- 5 Click **OK**.

Add a **Force Calculation** feature to define the force and torque variables from the rotor and stator.

Force Calculation Rotor

- 1 In the **Physics** toolbar, click  **Domains** and choose **Force Calculation**.
- 2 In the **Settings** window for **Force Calculation**, type Force Calculation Rotor in the **Label** text field.
- 3 Locate the **Domain Selection** section. From the **Selection** list, choose **Rotor**.
- 4 Locate the **Force Calculation** section. In the **Force name** text field, type rot.

Force Calculation Stator

- 1 Right-click **Force Calculation Rotor** and choose **Duplicate**.
- 2 In the **Settings** window for **Force Calculation**, type Force Calculation Stator in the **Label** text field.
- 3 Locate the **Domain Selection** section. From the **Selection** list, choose **Stator forces**.
- 4 Locate the **Force Calculation** section. In the **Force name** text field, type stat.

The **Weak Form Boundary PDE** physics is used for the single purpose of limiting the output of the model. The forces at the boundaries will be stored from the time dependent analysis and transformed into the frequency domain through a **Time to Frequency FFT** study step.

WEAK FORM BOUNDARY PDE (WB)

- 1 In the **Model Builder** window, under **Component 1 (comp1)** click **Weak Form Boundary PDE (wb)**.
- 2 In the **Settings** window for **Weak Form Boundary PDE**, locate the **Boundary Selection** section.
- 3 From the **Selection** list, choose **Force calculation**.
- 4 Click to expand the **Discretization** section. From the **Element order** list, choose **Linear**.

5 Click to expand the **Dependent Variables** section. In the **Number of dependent variables** text field, type 2.

6 In the **Dependent variables** table, enter the following settings:

F_x
F_y

7 Locate the **Units** section. Click  **Define Dependent Variable Unit**.

8 In the **Dependent variable quantity** table, enter the following settings:

Dependent variable quantity	Unit
Custom unit	N/m ²

9 Click  **Define Source Term Unit**.

10 In the **Source term quantity** table, enter the following settings:

Source term quantity	Unit
Custom unit	N/m ²

F_x and F_y take their values from the electromagnetic forces computed through the **Force Calculation** feature. As the rotor is rotating, some coordinate transformation is required.

Initial Values I

1 In the **Model Builder** window, under **Component 1 (comp1)> Weak Form Boundary PDE (wb)** click **Initial Values I**.

2 In the **Settings** window for **Initial Values**, locate the **Initial Values** section.

3 In the F_x text field, type `if(isnan(mf.nTx_stat),mf.nTx_rot*cos(rotation)+mf.nTy_rot*sin(rotation),mf.nTx_stat)`.

4 In the F_y text field, type `if(isnan(mf.nTy_stat),-mf.nTx_rot*sin(rotation)+mf.nTy_rot*cos(rotation),mf.nTy_stat)`.

Now proceed to mesh the Component 1.

MESH I

1 In the **Model Builder** window, under **Component 1 (comp1)** click **Mesh I**.

2 In the **Settings** window for **Mesh**, locate the **Mesh Settings** section.

3 From the **Sequence type** list, choose **User-controlled mesh**.

Size

1 In the **Model Builder** window, under **Component 1 (comp1)>Mesh I** click **Size**.

- 2 In the **Settings** window for **Size**, locate the **Element Size** section.
- 3 Click the **Custom** button.
- 4 Locate the **Element Size Parameters** section. In the **Maximum element size** text field, type 4 [mm].
- 5 In the **Minimum element size** text field, type 1 [mm].
- 6 In the **Maximum element growth rate** text field, type 1.15.
- 7 In the **Curvature factor** text field, type 0.1.

Size I

- 1 In the **Model Builder** window, right-click **Free Triangular I** and choose **Size**.
- 2 In the **Settings** window for **Size**, locate the **Geometric Entity Selection** section.
- 3 From the **Geometric entity level** list, choose **Boundary**.
- 4 From the **Selection** list, choose **Force calculation**.
- 5 Locate the **Element Size** section. Click the **Custom** button.
- 6 Locate the **Element Size Parameters** section. Select the **Maximum element size** check box.
- 7 In the associated text field, type 0.3 [mm].
- 8 Select the **Minimum element size** check box.
- 9 In the associated text field, type 0.15 [mm].
- 10 Select the **Maximum element growth rate** check box.
- 11 In the associated text field, type 1.05.
- 12 Select the **Curvature factor** check box.
- 13 In the associated text field, type 0.05.
- 14 Click  **Build All**.

Add a **Boundary Layer** feature to make the force calculation more precise.

Boundary Layers I

- 1 In the **Mesh** toolbar, click  **Boundary Layers**.
- 2 In the **Settings** window for **Boundary Layers**, click to expand the **Transition** section.
- 3 Clear the **Smooth transition to interior mesh** check box.

Boundary Layer Properties

- 1 In the **Model Builder** window, click **Boundary Layer Properties**.
- 2 In the **Settings** window for **Boundary Layer Properties**, locate the **Boundary Selection** section.

- 3 From the **Selection** list, choose **Force calculation**.
- 4 Locate the **Boundary Layer Properties** section. In the **Number of boundary layers** text field, type 1.
- 5 Click  **Build All**.

The image should look like this.

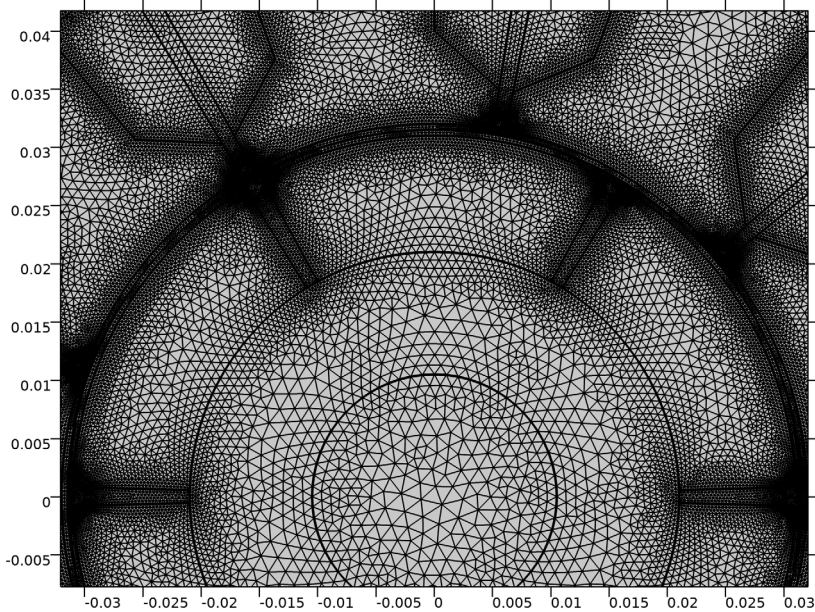

STUDY 1

Time Dependent

- 1 In the **Study** toolbar, click  **Study Steps** and choose **Time Dependent> Time Dependent**.
- 2 In the **Settings** window for **Time Dependent**, locate the **Study Settings** section.
- 3 In the **Output times** text field, type $\text{range}(0, 1/6/n_{\text{harmonics}}, 1) * t_{\text{tot}}$.
- 4 Locate the **Physics and Variables Selection** section. In the table, clear the **Solve for** checkbox for **Weak Form Boundary PDE (wb)**.
- 5 Click to expand the **Values of Dependent Variables** section. Find the **Initial values of variables solved for** subsection. From the **Settings** list, choose **User controlled**.
- 6 From the **Method** list, choose **Solution**.

- 7 From the **Study** list, choose **Study 1, Stationary**.
- 8 Click to expand the **Mesh Selection** section. There is no need to use any the mesh coming from the second component.
- 9 In the table, enter the following settings:

Geometry	Mesh
Geometry 2	No mesh

Step 1: Stationary



- 1 In the **Model Builder** window, click **Step 1: Stationary**.
- 2 In the **Settings** window for **Stationary**, locate the **Physics and Variables Selection** section.
- 3 In the table, clear the **Solve for** check box for **Weak Form Boundary PDE (wb)**.
- 4 Click to expand the **Mesh Selection** section. There is no need to use any the mesh coming from the second component.
- 5 In the table, enter the following settings:

Geometry	Mesh
Geometry 2	No mesh

Change the solver options by showing the default solver.

- 6 In the **Model Builder** window, click **Study 1**.
- 7 In the **Settings** window for **Study**, type Study 1 - Electromagnetic Analysis in the **Label** text field.

Solution 1 (sol1)

- 1 In the **Study** toolbar, click  **Show Default Solver**.
- 2 In the **Model Builder** window, expand the **Solution 1 (sol1)** node.
- 3 In the **Model Builder** window, expand the **Study 1 - Electromagnetic Analysis> Solver Configurations>Solution 1 (sol1)>Time-Dependent Solver 1** node, then click **Fully Coupled 1**.
- 4 In the **Settings** window for **Fully Coupled**, click to expand the **Method and Termination** section.
- 5 From the **Jacobian update** list, choose **On every iteration**.
Turning the Jacobian update to every iteration will reduce the running time.
- 6 In the **Study** toolbar, click  **Compute**.

RESULTS

Magnetic Flux Density Norm (mf)

The following steps guide you through the postprocess of the model.

Study 1 - Electromagnetic Analysis/Solution 1 (sol1)

In the **Model Builder** window, expand the **Results>Datasets** node.

Surface 1

- 1 In the **Model Builder** window, expand the **Results>Magnetic Flux Density Norm (mf)** node, then click **Surface 1**.
- 2 In the **Settings** window for **Surface**, click to expand the **Range** section.
- 3 Select the **Manual color range** check box.
- 4 In the **Minimum** text field, type 0.
- 5 In the **Maximum** text field, type 1.5.

Magnetic Flux Density Norm (mf)

- 1 In the **Model Builder** window, click **Magnetic Flux Density Norm (mf)**.
- 2 In the **Settings** window for **2D Plot Group**, click to expand the **Title** section.
- 3 From the **Title type** list, choose **Label**.
- 4 Locate the **Color Legend** section. Clear the **Show legends** check box.

Arrow Line 1

- 1 Right-click **Magnetic Flux Density Norm (mf)** and choose **Arrow Line**.
- 2 In the **Settings** window for **Arrow Line**, locate the **Expression** section.
- 3 In the **x component** text field, type $mf.nTx_stat$.
- 4 In the **y component** text field, type $mf.nTy_stat$.
- 5 Locate the **Arrow Positioning** section. From the **Placement** list, choose **Gauss points**.
- 6 In the **Magnetic Flux Density Norm (mf)** toolbar, click  **Plot**.

Arrow Line 2

- 1 Right-click **Magnetic Flux Density Norm (mf)** and choose **Arrow Line**.
- 2 In the **Settings** window for **Arrow Line**, locate the **Expression** section.
- 3 In the **x component** text field, type $mf.nTx_rot$.
- 4 In the **y component** text field, type $mf.nTy_rot$.
- 5 Locate the **Arrow Positioning** section. From the **Placement** list, choose **Gauss points**.
- 6 Click to expand the **Title** section. From the **Title type** list, choose **None**.

7 Locate the **Coloring and Style** section. From the **Color** list, choose **Blue**.

8 In the **Magnetic Flux Density Norm (mf)** toolbar, click  **Plot**.

Loop through the different frequencies to reproduce the plots in [Figure 6](#)

Electromagnetic Forces in Selected Points, Time Domain

1 In the **Home** toolbar, click  **Add Plot Group** and choose **ID Plot Group**.

2 In the **Settings** window for **ID Plot Group**, type **Electromagnetic Forces in Selected Points, Time Domain** in the **Label** text field.

3 Locate the **Plot Settings** section. Select the **y-axis label** check box.

4 In the associated text field, type **Stress (MPa)**.

5 Click to expand the **Title** section. From the **Title type** list, choose **Label**.

6 Locate the **Legend** section. From the **Position** list, choose **Lower right**.

Point Graph 1

1 Right-click **Electromagnetic Forces in Selected Points, Time Domain** and choose **Point Graph**.

2 Select Point 174 only.

3 In the **Settings** window for **Point Graph**, locate the **y-Axis Data** section.

4 In the **Expression** text field, type `abs(mf.nTx_stat)`.

5 From the **Unit** list, choose **MPa**.

6 Select the **Description** check box.

7 In the associated text field, type `Absolute x stress`.

8 Click to expand the **Legends** section. Select the **Show legends** check box.

9 Find the **Include** subsection. Select the **Description** check box.

10 Click to expand the **Coloring and Style** section. Find the **Line markers** subsection. From the **Marker** list, choose **Point**.

11 From the **Positioning** list, choose **In data points**.

12 In the **Electromagnetic Forces in Selected Points, Time Domain** toolbar, click  **Plot**.

Point Graph 2

1 Right-click **Point Graph 1** and choose **Duplicate**.

2 In the **Settings** window for **Point Graph**, locate the **y-Axis Data** section.

3 In the **Expression** text field, type `abs(mf.nTy_stat)`.

4 In the **Description** text field, type `Absolute y stress`.

Point Graph 3

- 1 Right-click **Point Graph 2** and choose **Duplicate**.
- 2 In the **Settings** window for **Point Graph**, locate the **Selection** section.
- 3 Click  **Clear Selection**.
- 4 Select Point 176 only.
- 5 Locate the **y-Axis Data** section. In the **Expression** text field, type `abs(mf.nTx_stat)`.
- 6 In the **Description** text field, type `Absolute x stress`.

Point Graph 4

- 1 Right-click **Point Graph 3** and choose **Duplicate**.
- 2 In the **Settings** window for **Point Graph**, locate the **y-Axis Data** section.
- 3 In the **Expression** text field, type `abs(mf.nTy_stat)`.
- 4 In the **Description** text field, type `Absolute y stress`.
- 5 In the **Electromagnetic Forces in Selected Points, Time Domain** toolbar, click  **Plot**.
The image should look like [Figure 7](#).

Electromagnetic Forces in Selected Points, FFT

- 1 In the **Model Builder** window, right-click **Electromagnetic Forces in Selected Points, Time Domain** and choose **Duplicate**.
- 2 In the **Model Builder** window, click **Electromagnetic Forces in Selected Points, Time Domain I**.
- 3 In the **Settings** window for **ID Plot Group**, type `Electromagnetic Forces in Selected Points, FFT` in the **Label** text field.
- 4 Locate the **Plot Settings** section. Select the **x-axis label** check box.
- 5 In the associated text field, type `Frequency (Hz)`.
- 6 In the **y-axis label** text field, type `Fourier Coefficient (MPa)`.
- 7 Locate the **Legend** section. From the **Position** list, choose **Upper right**.

Point Graph 1

- 1 In the **Model Builder** window, click **Point Graph 1**.
- 2 In the **Settings** window for **Point Graph**, locate the **x-Axis Data** section.
- 3 From the **Parameter** list, choose **Frequency spectrum**.
- 4 Select the **Frequency range** check box.
- 5 In the **Minimum** text field, type `f0/2`.
- 6 In the **Maximum** text field, type `f0*(n_harmonics+1)`.

Point Graph 2

- 1 In the **Model Builder** window, click **Point Graph 2**.
- 2 In the **Settings** window for **Point Graph**, locate the **x-Axis Data** section.
- 3 From the **Parameter** list, choose **Frequency spectrum**.
- 4 Select the **Frequency range** check box.
- 5 In the **Minimum** text field, type $f_0/2$.
- 6 In the **Maximum** text field, type $f_0 \cdot (n_{\text{harmonics}} + 1)$.

Point Graph 3

- 1 In the **Model Builder** window, click **Point Graph 3**.
- 2 In the **Settings** window for **Point Graph**, locate the **x-Axis Data** section.
- 3 From the **Parameter** list, choose **Frequency spectrum**.
- 4 Select the **Frequency range** check box.
- 5 In the **Minimum** text field, type $f_0/2$.
- 6 In the **Maximum** text field, type $f_0 \cdot (n_{\text{harmonics}} + 1)$.

Point Graph 4

- 1 In the **Model Builder** window, click **Point Graph 4**.
- 2 In the **Settings** window for **Point Graph**, locate the **x-Axis Data** section.
- 3 From the **Parameter** list, choose **Frequency spectrum**.
- 4 Select the **Frequency range** check box.
- 5 In the **Minimum** text field, type $f_0/2$.
- 6 In the **Maximum** text field, type $f_0 \cdot (n_{\text{harmonics}} + 1)$.
- 7 Click the  **y-Axis Log Scale** button in the **Graphics** toolbar.

- 8 In the **Electromagnetic Forces in Selected Points, FFT** toolbar, click  **Plot**.
The image should look like this.

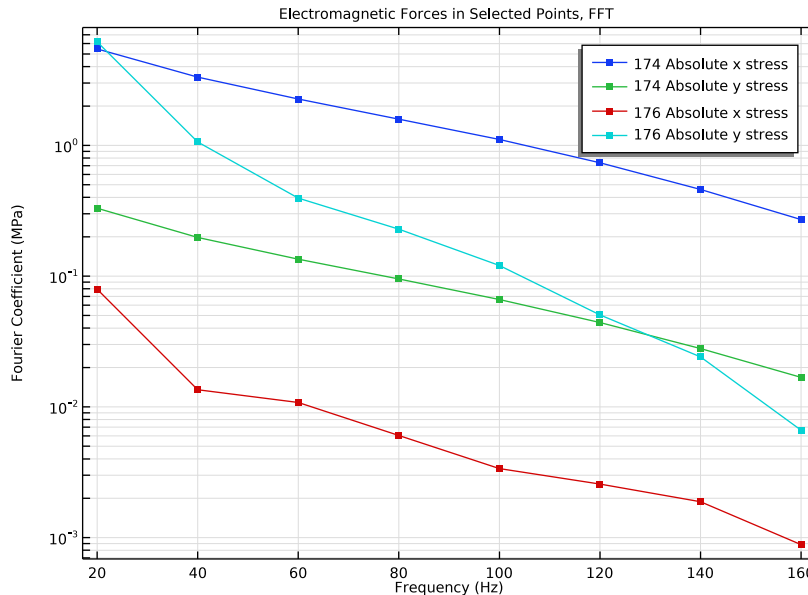

Electromagnetic Forces in Selected Points, FFT , Normalized to First Harmonic

- 1 In the **Model Builder** window, right-click **Electromagnetic Forces in Selected Points, FFT** and choose **Duplicate**.
- 2 In the **Settings** window for **ID Plot Group**, type **Electromagnetic Forces in Selected Points, FFT , Normalized to First Harmonic** in the **Label** text field.
- 3 Locate the **Plot Settings** section. In the **y-axis label** text field, type **Normalized Fourier Coefficient (1)**.
- 4 Locate the **Legend** section. From the **Position** list, choose **Lower left**.

Now proceed to normalize the values using the first harmonic coefficient.

Point Graph 1

- 1 In the **Model Builder** window, expand the **Electromagnetic Forces in Selected Points, FFT , Normalized to First Harmonic** node, then click **Point Graph 1**.
- 2 In the **Settings** window for **Point Graph**, locate the **y-Axis Data** section.
- 3 In the **Expression** text field, type `abs(mf.nTx_stat)/5.4675[MPa]`.

- 4 In the **Description** text field, type Absolute x stress normalized to first harmonic.

Point Graph 2

- 1 In the **Model Builder** window, click **Point Graph 2**.
- 2 In the **Settings** window for **Point Graph**, locate the **y-Axis Data** section.
- 3 In the **Expression** text field, type $\text{abs}(\text{mf.nTy_stat})/0.330696[\text{MPa}]$.
- 4 In the **Description** text field, type Absolute y stress normalized to first harmonic.

Point Graph 3

- 1 In the **Model Builder** window, click **Point Graph 3**.
- 2 In the **Settings** window for **Point Graph**, locate the **y-Axis Data** section.
- 3 In the **Expression** text field, type $\text{abs}(\text{mf.nTx_stat})/0.079339[\text{MPa}]$.
- 4 In the **Description** text field, type Absolute x stress normalized to first harmonic.

Point Graph 4

- 1 In the **Model Builder** window, click **Point Graph 4**.
- 2 In the **Settings** window for **Point Graph**, locate the **y-Axis Data** section.
- 3 In the **Expression** text field, type $\text{abs}(\text{mf.nTy_stat})/6.187[\text{MPa}]$.
- 4 In the **Description** text field, type Absolute y stress normalized to first harmonic.
- 5 In the **Electromagnetic Forces in Selected Points, FFT , Normalized to First Harmonic** toolbar, click  **Plot**.

The image should look like [Figure 8](#).

Create a new study to transform the electromagnetic forces to the frequency domain.

ROOT

In the **Home** toolbar, click  **Windows** and choose **Add Study**.



ADD STUDY

- 1 Go to the **Add Study** window.
- 2 Find the **Studies** subsection. In the **Select Study** tree, select **Empty Study**.
- 3 Click **Add Study** in the window toolbar.
- 4 In the **Home** toolbar, click  **Add Study** to close the **Add Study** window.

STUDY 2 - ELECTROMAGNETIC FORCES FFT

In the **Settings** window for **Study**, type Study 2 - Electromagnetic Forces FFT in the **Label** text field.

Time to Frequency FFT

- 1 In the **Study** toolbar, click  **Study Steps** and choose **Frequency Domain> Time to Frequency FFT**.
- 2 In the **Settings** window for **Time to Frequency FFT**, locate the **Study Settings** section.
- 3 From the **Prescribed by** list, choose **Initial expression**.
- 4 From the **Input study** list, choose **Study 1 - Electromagnetic Analysis, Time Dependent**.
- 5 In the **End time** text field, type t_{tot} .
- 6 In the **Maximum output frequency** text field, type $n_{harmonics}/t_{tot}$.
- 7 Locate the **Physics and Variables Selection** section. In the table, clear the **Solve for** check box for **Magnetic Fields (mf)**.
- 8 In the **Study** toolbar, click  **Compute**.

RESULTS

Electromagnetic Forces, FFT

- 1 In the **Settings** window for **2D Plot Group**, type Electromagnetic Forces, FFT in the **Label** text field.
- 2 Locate the **Plot Settings** section. Clear the **Plot dataset edges** check box.

Line 1

- 1 In the **Model Builder** window, expand the **Electromagnetic Forces, FFT** node, then click **Line 1**.
- 2 In the **Settings** window for **Line**, click to expand the **Title** section.
- 3 From the **Title type** list, choose **None**.
- 4 Locate the **Coloring and Style** section. From the **Line type** list, choose **Tube**.
- 5 In the **Tube radius expression** text field, type 0.0002 .
- 6 Select the **Radius scale factor** check box.
- 7 From the **Coloring** list, choose **Uniform**.
- 8 From the **Color** list, choose **Black**.

Arrow Line 1

- 1 In the **Model Builder** window, right-click **Electromagnetic Forces, FFT** and choose **Arrow Line**.

- 2 In the **Settings** window for **Arrow Line**, locate the **Expression** section.
- 3 In the **x component** text field, type $\text{real}(F_x) / t_{\text{tot}}$.
- 4 In the **y component** text field, type $\text{real}(F_y) / t_{\text{tot}}$.
- 5 Select the **Description** check box.
- 6 In the associated text field, type **Real Force Components (Red)**.
- 7 Locate the **Arrow Positioning** section. From the **Placement** list, choose **Gauss points**.
- 8 In the **Electromagnetic Forces, FFT** toolbar, click  **Plot**.

Arrow Line 2

- 1 Right-click **Electromagnetic Forces, FFT** and choose **Arrow Line**.
- 2 In the **Settings** window for **Arrow Line**, locate the **Expression** section.
- 3 In the **x component** text field, type $\text{imag}(F_x) / t_{\text{tot}}$.
- 4 In the **y component** text field, type $\text{imag}(F_y) / t_{\text{tot}}$.
- 5 Select the **Description** check box.
- 6 In the associated text field, type **Imaginary Force Components (Blue)**.
- 7 Locate the **Arrow Positioning** section. From the **Placement** list, choose **Gauss points**.
- 8 Locate the **Coloring and Style** section. From the **Color** list, choose **Blue**.
- 9 In the **Electromagnetic Forces, FFT** toolbar, click  **Plot**.

The image should look like [Figure 9](#).

Electromagnetic Forces in Selected Points, FFT, Electromagnetic Forces in Selected Points, FFT , Normalized to First Harmonic, Electromagnetic Forces in Selected Points, Time Domain, Electromagnetic Forces, FFT, Magnetic Flux Density Norm (mf)

- 1 In the **Model Builder** window, under **Results**, Ctrl-click to select **Magnetic Flux Density Norm (mf)**, **Electromagnetic Forces in Selected Points, Time Domain**, **Electromagnetic Forces in Selected Points, FFT**, **Electromagnetic Forces in Selected Points, FFT , Normalized to First Harmonic**, and **Electromagnetic Forces, FFT**.
- 2 Right-click and choose **Group**.

Electromagnetic Results

In the **Settings** window for **Group**, type **Electromagnetic Results** in the **Label** text field.

COMPONENT 2 (COMP2)

Add the physics used in the Component 2.

- 1 In the **Model Builder** window, click **Component 2 (comp2)**.

2 In the **Home** toolbar, click  **Windows** and choose **Add Physics**.

ADD PHYSICS

- 1 Go to the **Add Physics** window.
- 2 Find the **Physics interfaces in study** subsection. In the table, clear the **Solve** check boxes for **Study 1 - Electromagnetic Analysis** and **Study 2 - Electromagnetic Forces FFT**.
- 3 In the tree, select **Acoustics>Acoustic-Structure Interaction>Acoustic-Solid Interaction, Frequency Domain**.
- 4 Click **Add to Component 2** in the window toolbar.
- 5 In the **Home** toolbar, click  **Add Physics** to close the **Add Physics** window.

PRESSURE ACOUSTICS, FREQUENCY DOMAIN (ACPR)

- 1 In the **Settings** window for **Pressure Acoustics, Frequency Domain**, locate the **Domain Selection** section.
- 2 From the **Selection** list, choose **Air**.

Add the **Exterior Field Calculation** feature to obtain the acoustic field in any distant point.

Exterior Field Calculation 1

- 1 Right-click **Component 2 (comp2)>Pressure Acoustics, Frequency Domain (acpr)** and choose **Exterior Field Calculation**.
- 2 In the **Settings** window for **Exterior Field Calculation**, locate the **Boundary Selection** section.
- 3 From the **Selection** list, choose **Exterior Field Calculation**.
- 4 Locate the **Exterior Field Calculation** section. From the **Condition in the $z = z^0$ plane** list, choose **Symmetric/Infinite sound hard boundary**.
- 5 In the z_0 text field, type -0.073.

SOLID MECHANICS (SOLID)

- 1 In the **Model Builder** window, under **Component 2 (comp2)** click **Solid Mechanics (solid)**.
- 2 In the **Settings** window for **Solid Mechanics**, locate the **Domain Selection** section.
- 3 From the **Selection** list, choose **Structure**.

Fixed Constraint 1

- 1 In the **Physics** toolbar, click  **Boundaries** and choose **Fixed Constraint**.
- 2 In the **Settings** window for **Fixed Constraint**, locate the **Boundary Selection** section.
- 3 From the **Selection** list, choose **Fixed Boundaries**.

Linear Elastic Material 1

In the **Model Builder** window, click **Linear Elastic Material 1**.

Damping 1

- 1 In the **Physics** toolbar, click  **Attributes** and choose **Damping**.
- 2 In the **Settings** window for **Damping**, locate the **Damping Settings** section.
- 3 From the **Input parameters** list, choose **Damping ratios**.
- 4 In the f_1 text field, type f_0 .
- 5 In the ζ_1 text field, type η_{struct} .
- 6 In the f_2 text field, type f_{max} .
- 7 In the ζ_2 text field, type η_{struct} .

Use the **Boundary Load** feature to apply the electromagnetic loads coming from the previous steps. Through the use of the `withsol` operator, the loads will be taken from the different harmonics of Study 2 and applied to the current physics through a parametric sweep.

Boundary Load 1

- 1 In the **Physics** toolbar, click  **Boundaries** and choose **Boundary Load**.
- 2 In the **Settings** window for **Boundary Load**, locate the **Boundary Selection** section.
- 3 From the **Selection** list, choose **Loaded Boundaries**.



In these expressions, `tor(rpm)` is the torque-speed normalized curve, `comp1.genext1` is the operator that brings variables existing in the Component 1 to Component 2.

- 4 Locate the **Force** section. Specify the \mathbf{F}_A vector as

0	x
<code>tor(rpm)*comp1.genext1(withsol('sol3',Fx,setval(freq,20[Hz]*(harm_exc))))</code>	y
<code>tor(rpm)*comp1.genext1(withsol('sol3',Fy,setval(freq,20[Hz]*(harm_exc))))</code>	z

Add a **Continuity** feature to make sure that the displacement is continuous through the identity pair.

Continuity 1

- 1 In the **Physics** toolbar, click  **Pairs** and choose **Continuity**.
- 2 In the **Settings** window for **Continuity**, locate the **Pair Selection** section.
- 3 Under **Pairs**, click  **Add**.

4 In the **Add** dialog box, select **Identity Boundary Pair I (apI)** in the **Pairs** list.

5 Click **OK**.

In the following steps, create a mesh that will minimize the running time while maintaining the accuracy.

MESH 2

Free Triangular I

1 In the **Mesh** toolbar, click  **Boundary** and choose **Free Triangular**.

Start by meshing a section of the motor.

2 In the **Settings** window for **Free Triangular**, locate the **Boundary Selection** section.

3 From the **Selection** list, choose **Meshed Section**.

Size

1 In the **Model Builder** window, click **Size**.

2 In the **Settings** window for **Size**, locate the **Element Size** section.

3 Click the **Custom** button.

4 Locate the **Element Size Parameters** section. In the **Maximum element size** text field, type $c0/fmax/5$.

5 In the **Minimum element size** text field, type 3[mm].

6 Click  **Build All**.

Size I

1 In the **Model Builder** window, right-click **Free Triangular I** and choose **Size**.

2 In the **Settings** window for **Size**, locate the **Element Size** section.

3 Click the **Custom** button.

4 Locate the **Element Size Parameters** section. Select the **Maximum element size** check box.

5 In the associated text field, type 10[mm].

6 Select the **Minimum element size** check box.

7 In the associated text field, type 0.3[mm].

8 Select the **Maximum element growth rate** check box.

9 In the associated text field, type 1.2.

10 Select the **Curvature factor** check box.

11 In the associated text field, type 0.1.

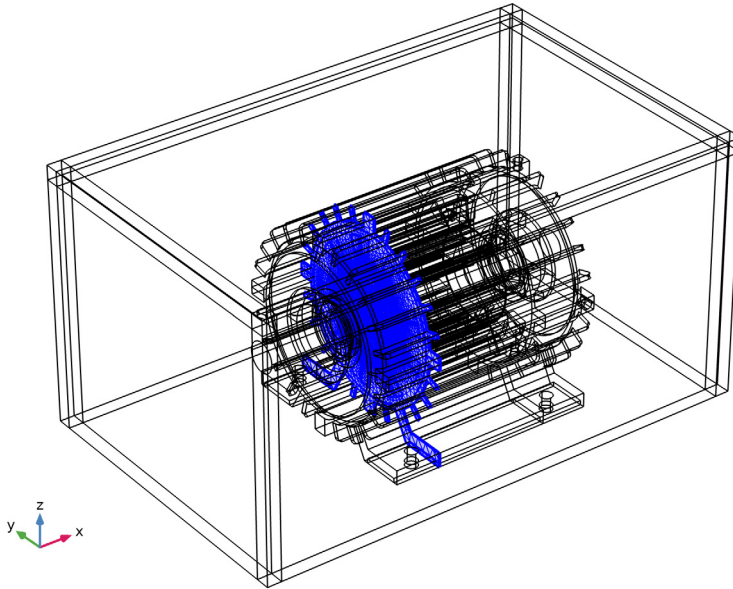

12 Click  **Build Selected**.

The image should look like this.



As the geometry is build using an assembly, it is advisable to copy the mesh so the extrapolation of displacements at the boundary is simpler.

Copy Face 1

- 1 In the **Mesh** toolbar, click  **Copy** and choose **Copy Face**.
- 2 Select Boundary 431 only.
- 3 In the **Settings** window for **Copy Face**, locate the **Destination Boundaries** section.
- 4 Select the  **Activate Selection** toggle button.
- 5 Select Boundary 916 only.
- 6 Click  **Build Selected**.

Swept 1

- 1 In the **Mesh** toolbar, click  **Swept**.
- 2 In the **Settings** window for **Swept**, locate the **Domain Selection** section.
- 3 From the **Geometric entity level** list, choose **Domain**.
- 4 From the **Selection** list, choose **Sweep Domain**.

- 5 Click  **Build Selected**.

The image should look like this.

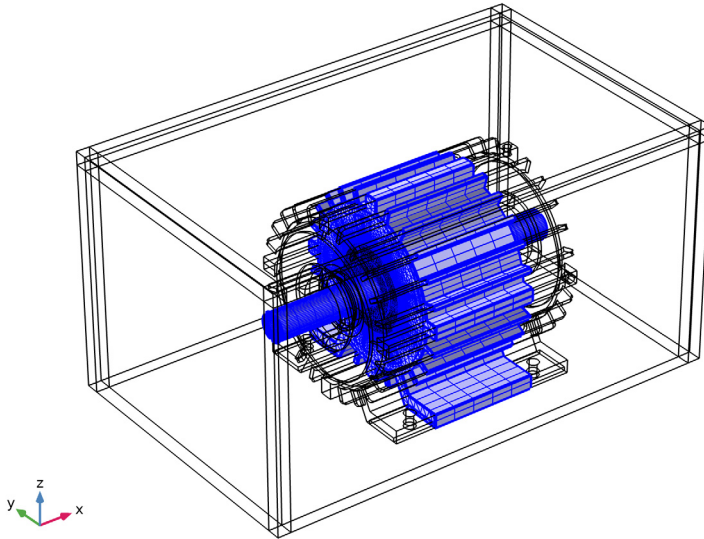

Free Tetrahedral 1

- 1 In the **Mesh** toolbar, click  **Free Tetrahedral**.
- 2 In the **Settings** window for **Free Tetrahedral**, locate the **Domain Selection** section.
- 3 From the **Geometric entity level** list, choose **Domain**.
- 4 From the **Selection** list, choose **Tetrahedral Domains**.
- 5 Click  **Build Selected**.

Swept 2

- 1 In the **Mesh** toolbar, click  **Swept**.
- 2 In the **Settings** window for **Swept**, locate the **Domain Selection** section.
- 3 From the **Geometric entity level** list, choose **Domain**.
- 4 From the **Selection** list, choose **PML**.

Distribution 1

- 1 Right-click **Swept 2** and choose **Distribution**.
- 2 In the **Settings** window for **Distribution**, locate the **Distribution** section.

3 In the **Number of elements** text field, type 6.

4 Click  **Build Selected**.

Boundary Layers 1

1 In the **Mesh** toolbar, click  **Boundary Layers**.

2 In the **Settings** window for **Boundary Layers**, locate the **Geometric Entity Selection** section.

3 From the **Geometric entity level** list, choose **Domain**.

4 Select Domain 9 only.

5 Click to expand the **Transition** section. Clear the **Smooth transition to interior mesh** check box.

Boundary Layer Properties

1 In the **Model Builder** window, click **Boundary Layer Properties**.

2 In the **Settings** window for **Boundary Layer Properties**, locate the **Boundary Layer Properties** section.

3 In the **Number of boundary layers** text field, type 1.

4 Locate the **Boundary Selection** section. From the **Selection** list, choose **Exterior Field Calculation**.

5 Click  **Build Selected**.

The image should look like this.

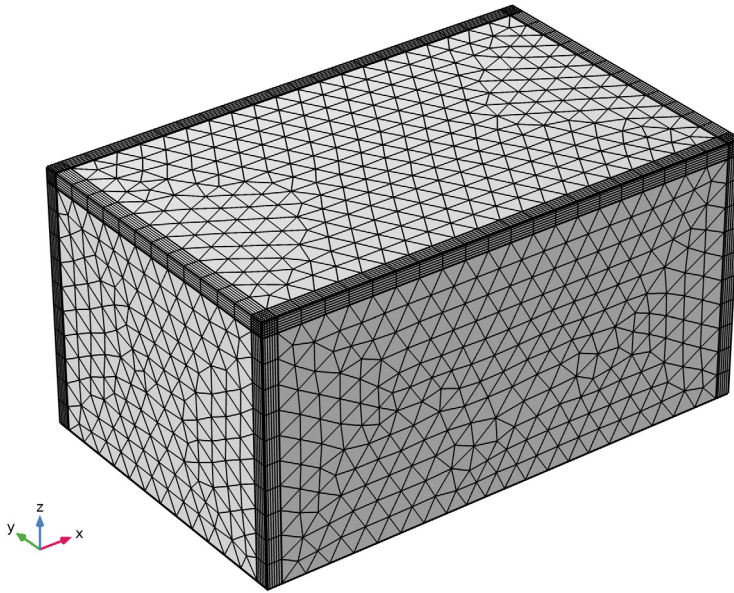

DEFINITIONS (COMP2)

Variables 2

1 In the **Model Builder** window, under **Component 2 (comp2)** right-click **Definitions** and choose **Variables**.

Add a few variables that will help you to postprocess the model.

2 In the **Settings** window for **Variables**, locate the **Variables** section.

3 In the table, enter the following settings:

Name	Expression	Unit	Description
rpm	$\text{acpr.freq}/f0*\text{rpm0}/\text{harm_exc}$	1/s	Revolutions
p_mic1	$\text{subst}(\text{abs}(\text{acpr.efc1.pext}),x,0,y,0,z,z_mic1)$	Pa	Absolute pressure at microphone 1
spl_mic1	$\text{subst}(\text{acpr.efc1.Lp_pext},x,0,y,0,z,z_mic1)$	dB	Sound pressure level at microphone 1

Name	Expression	Unit	Description
p_mic2	subst(abs(acpr.efc1.pex t),x,0,y,y_mic2,z,0)	Pa	Absolute pressure at microphone 2
spl_mic2	subst(acpr.efc1.Lp_pext ,x,0,y,y_mic2,z,0)	dB	Sound pressure level at microphone 2

Add a torque-speed normalized curve.

Torque curve

- 1 In the **Home** toolbar, click  **Functions** and choose **Local>Analytic**.
- 2 In the **Settings** window for **Analytic**, type Torque curve in the **Label** text field.
- 3 In the **Function name** text field, type tor.
- 4 Locate the **Definition** section. In the **Expression** text field, type $\text{if}(\text{rev} < 4000, 1, 4000 / \text{rev})$.
- 5 In the **Arguments** text field, type rev.
- 6 Locate the **Units** section. In the **Arguments** text field, type rpm.
- 7 In the **Function** text field, type 1.
- 8 Locate the **Plot Parameters** section. In the table, enter the following settings:

Argument	Lower limit	Upper limit
rev	0	10000 [rpm]

- 9 Click  **Plot**.

The image should look like [Figure 3](#).

An acoustic signal will be generated later. This signal is generated as the motor accelerates through time. Proceed to create a revolutions-time curve.

Revolutions ramp

- 1 In the **Home** toolbar, click  **Functions** and choose **Local>Analytic**.
- 2 In the **Settings** window for **Analytic**, type Revolutions ramp in the **Label** text field.
- 3 In the **Function name** text field, type rev_ramp.
- 4 Locate the **Definition** section. In the **Expression** text field, type $200 + 9800 * t / 20$ [s].
- 5 In the **Arguments** text field, type t.
- 6 Locate the **Units** section. In the **Arguments** text field, type s.
- 7 In the **Function** text field, type rpm.

8 Locate the **Plot Parameters** section. In the table, enter the following settings:

Argument	Lower limit	Upper limit
t	0	20 [s]

9 Click  **Plot**.

The image should look like [Figure 5](#).

Add a **Perfectly Matched Layer** domain to represent the open domain surrounding the motor.

Perfectly Matched Layer 1 (pml1)

- 1 In the **Definitions** toolbar, click  **Perfectly Matched Layer**.
- 2 In the **Settings** window for **Perfectly Matched Layer**, locate the **Domain Selection** section.
- 3 From the **Selection** list, choose **PML**.
- 4 Locate the **Scaling** section. From the **Coordinate stretching type** list, choose **Rational**.

MATERIALS

In the **Home** toolbar, click  **Windows** and choose **Add Material from Library**.

ADD MATERIAL

- 1 Go to the **Add Material** window.
- 2 In the tree, select **Built-in>Air**.
- 3 Click **Add to Component** in the window toolbar.
- 4 In the tree, select **Built-in>Steel AISI 4340**.
- 5 Click **Add to Component** in the window toolbar.
- 6 In the tree, select **Built-in>Aluminum 6063-T83**.
- 7 Click **Add to Component** in the window toolbar.
- 8 In the **Home** toolbar, click  **Add Material** to close the **Add Material** window.

MATERIALS

Air (mat6)

- 1 In the **Model Builder** window, under **Component 2 (comp2)>Materials** click **Air (mat6)**.
- 2 In the **Settings** window for **Material**, locate the **Geometric Entity Selection** section.
- 3 From the **Selection** list, choose **Air**.

Steel AISI 4340 (mat7)

- 1 In the **Model Builder** window, click **Steel AISI 4340 (mat7)**.
- 2 In the **Settings** window for **Material**, locate the **Geometric Entity Selection** section.
- 3 From the **Selection** list, choose **Iron**.

Aluminum 6063-T83 (mat8)

- 1 In the **Model Builder** window, click **Aluminum 6063-T83 (mat8)**.
- 2 In the **Settings** window for **Material**, locate the **Geometric Entity Selection** section.
- 3 From the **Selection** list, choose **Aluminum**.

Coil

- 1 In the **Model Builder** window, right-click **Materials** and choose **Blank Material**.

The coils are made of copper wires. The stiffness of the wire assembly is significantly smaller than that of copper.

- 2 In the **Settings** window for **Material**, type Coil in the **Label** text field.
- 3 Locate the **Geometric Entity Selection** section. From the **Selection** list, choose **Coils**.
- 4 Locate the **Material Contents** section. In the table, enter the following settings:

Property	Variable	Value	Unit	Property group
Young's modulus	E	5 [GPa]	Pa	Basic
Poisson's ratio	nu	0.3	l	Basic
Density	rho	8960 [kg/m ³]	kg/m ³	Basic

ROOT

In the **Home** toolbar, click  **Windows** and choose **Add Study**.

ADD STUDY

- 1 Go to the **Add Study** window.
- 2 Find the **Physics interfaces in study** subsection. In the table, clear the **Solve** check boxes for **Magnetic Fields (mf)** and **Weak Form Boundary PDE (wb)**.
- 3 Find the **Studies** subsection. In the **Select Study** tree, select **General Studies> Frequency Domain**.
- 4 Click **Add Study** in the window toolbar.
- 5 In the **Model Builder** window, click the root node.
- 6 In the **Home** toolbar, click  **Add Study** to close the **Add Study** window.

STUDY 3

Step 1: Frequency Domain

This expression gives uniform steps through the sweep up to the maximum revolutions or frequency are reached.

- 1 In the **Settings** window for **Frequency Domain**, locate the **Study Settings** section.
- 2 In the **Frequencies** text field, type $\text{range}(f_0 \cdot \text{harm_exc}, f_{\text{delta}}, \min(f_{\text{max}}, \text{rpm_max} / \text{rpm}_0 \cdot f_0 \cdot \text{harm_exc})) \min(f_{\text{max}}, \text{rpm_max} / \text{rpm}_0 \cdot f_0 \cdot \text{harm_exc})$.
- 3 Click to expand the **Values of Dependent Variables** section. Find the **Store fields in output** subsection. From the **Settings** list, choose **For selections**.
- 4 Under **Selections**, click **+ Add**.
- 5 In the **Add** dialog box, select **Exterior Field Calculation** in the **Selections** list.
- 6 Click **OK**.
- 7 In the **Model Builder** window, click **Study 3**.
- 8 In the **Settings** window for **Study**, type **Study 3 - Vibroacoustic Analysis - all Harmonics** and **Frequencies** in the **Label** text field.
- 9 Locate the **Study Settings** section. Clear the **Generate default plots** check box.

Add a parametric sweep that will sequentially excite the different harmonics.

Parametric Sweep



- 1 In the **Study** toolbar, click  **Parametric Sweep**.
- 2 In the **Settings** window for **Parametric Sweep**, locate the **Study Settings** section.
- 3 Click **+ Add**.
- 4 In the table, enter the following settings:

Parameter name	Parameter value list	Parameter unit
harm_exc (Harmonic excited in the vibroacoustic analysis)	$\text{range}(1, 1, n_{\text{harmonics}})$	

Change the solver to a segregated solver, where the displacements will be obtained first and then used to compute the acoustic pressure.

Solution 4 (sol4)

- 1 In the **Study** toolbar, click  **Show Default Solver**.
- 2 In the **Model Builder** window, expand the **Solution 4 (sol4)** node.

- 3 In the **Model Builder** window, expand the **Study 3 - Vibroacoustic Analysis - all Harmonics and Frequencies>Solver Configurations>Solution 4 (sol4)>Stationary Solver 1** node.
- 4 Right-click **Stationary Solver 1** and choose **Segregated**.
- 5 In the **Settings** window for **Segregated**, locate the **General** section.
- 6 From the **Termination technique** list, choose **Iterations**.
- 7 In the **Model Builder** window, expand the **Study 3 - Vibroacoustic Analysis - all Harmonics and Frequencies>Solver Configurations>Solution 4 (sol4)>Stationary Solver 1>Segregated 1** node, then click **Segregated Step**.
- 8 In the **Settings** window for **Segregated Step**, locate the **General** section.
- 9 In the **Variables** list, select **Pressure (comp2.p)**.
- 10 Under **Variables**, click  **Delete**.
- 11 In the **Model Builder** window, right-click **Segregated 1** and choose **Segregated Step**.
- 12 In the **Settings** window for **Segregated Step**, locate the **General** section.
- 13 Under **Variables**, click  **Add**.
- 14 In the **Add** dialog box, select **Pressure (comp2.p)** in the **Variables** list.
- 15 Click **OK**.
- 16 In the **Model Builder** window, click **Study 3 - Vibroacoustic Analysis - all Harmonics and Frequencies**.
- 17 In the **Settings** window for **Study**, locate the **Study Settings** section.
- 18 Clear the **Generate convergence plots** check box.
Due to the many frequencies requested, expect a long running time.
- 19 In the **Study** toolbar, click  **Compute**.

RESULTS

Study 3 - Vibroacoustic Analysis - all Harmonics and Frequencies/Parametric Solutions 1 (6) (sol5), Study 3 - Vibroacoustic Analysis - all Harmonics and Frequencies/Solution 4 (4) (sol4), Study 3 - Vibroacoustic Analysis - all Harmonics and Frequencies/Solution 4 (5) (sol4)

- 1 In the **Model Builder** window, under **Results>Datasets**, Ctrl-click to select **Study 3 - Vibroacoustic Analysis - all Harmonics and Frequencies/Solution 4 (4) (sol4)**, **Study 3 - Vibroacoustic Analysis - all Harmonics and Frequencies/Solution 4 (5) (sol4)**, and **Study 3 - Vibroacoustic Analysis - all Harmonics and Frequencies/Parametric Solutions 1 (6) (sol5)**.
- 2 Right-click and choose **Delete**.

Campbell Diagram, First Microphone

- 1 In the **Home** toolbar, click  **Add Plot Group** and choose **ID Plot Group**.
- 2 In the **Settings** window for **ID Plot Group**, type Campbell Diagram, First Microphone in the **Label** text field.
- 3 Locate the **Data** section. From the **Dataset** list, choose **Study 3 - Vibroacoustic Analysis - all Harmonics and Frequencies/Parametric Solutions I (sol5)**.
- 4 Locate the **Title** section. From the **Title type** list, choose **Label**.
- 5 Locate the **Legend** section. Select the **Show maximum and minimum values** check box.



Global I

- 1 Right-click **Campbell Diagram, First Microphone** and choose **Global**.
- 2 In the **Settings** window for **Global**, locate the **y-Axis Data** section.
- 3 In the table, enter the following settings:

Expression	Unit	Description
acpr.freq	Hz	Frequency

- 4 Locate the **x-Axis Data** section. From the **Parameter** list, choose **Expression**.
- 5 In the **Expression** text field, type rpm.
- 6 From the **Unit** list, choose **RPM**.
- 7 Click to expand the **Coloring and Style** section. Set the **Width** value to **4**.
- 8 Click to expand the **Legends** section. Clear the **Show legends** check box.

Color Expression I

- 1 Right-click **Global I** and choose **Color Expression**.
- 2 In the **Settings** window for **Color Expression**, locate the **Expression** section.
- 3 In the **Expression** text field, type spl_mic1.
- 4 In the **Campbell Diagram, First Microphone** toolbar, click  **Plot**.
- 5 Click to expand the **Range** section. Select the **Manual color range** check box.
- 6 In the **Minimum** text field, type 30.
- 7 In the **Maximum** text field, type 60.
- 8 In the **Campbell Diagram, First Microphone** toolbar, click  **Plot**.

The image should look like [Figure 13](#).

Campbell Diagram, Second Microphone

- 1 In the **Model Builder** window, right-click **Campbell Diagram, First Microphone** and choose **Duplicate**.
- 2 In the **Model Builder** window, click **Campbell Diagram, First Microphone 1**.
- 3 In the **Settings** window for **ID Plot Group**, type Campbell Diagram, Second Microphone in the **Label** text field.

Color Expression 1

- 1 In the **Model Builder** window, expand the **Results>Campbell Diagram, Second Microphone>Global 1** node, then click **Color Expression 1**.
- 2 In the **Settings** window for **Color Expression**, locate the **Expression** section.
- 3 In the **Expression** text field, type `spl_mic2`.
- 4 Locate the **Range** section. In the **Maximum** text field, type 75.
- 5 In the **Campbell Diagram, Second Microphone** toolbar, click  **Plot**.
The image should look like [Figure 13](#).

Exterior-Field Sound Pressure Level (acpr)

- 1 In the **Home** toolbar, click  **Add Plot Group** and choose **3D Plot Group**.
- 2 In the **Settings** window for **3D Plot Group**, type Exterior-Field Sound Pressure Level (acpr) in the **Label** text field.
- 3 Locate the **Data** section. From the **Parameter value (harm_exc)** list, choose **3**.
- 4 From the **Parameter value (freq (Hz))** list, choose **2360**.
- 5 Locate the **Color Legend** section. Select the **Show maximum and minimum values** check box.

Radiation Pattern 1

- 1 In the **Exterior-Field Sound Pressure Level (acpr)** toolbar, click  **More Plots** and choose **Radiation Pattern**.
- 2 In the **Settings** window for **Radiation Pattern**, locate the **Expression** section.
- 3 In the **Expression** text field, type `acpr.efc1.Lp_pext/80`.
- 4 Select the **Description** check box.
- 5 In the associated text field, type Exterior-field sound pressure level.
- 6 Clear the **Use as color expression** check box.
- 7 Click to expand the **Range** section. Select the **Manual color range** check box.
- 8 In the **Minimum** text field, type 40.

- 9 In the **Maximum** text field, type 65.
- 10 Locate the **Evaluation** section. Find the **Angles** subsection. In the **Number of elevation angles** text field, type 160.
- 11 In the **Number of azimuth angles** text field, type 240.
- 12 From the **Restriction** list, choose **Manual**.
- 13 In the θ **range** text field, type 90.
- 14 In the ϕ **start** text field, type -90.
- 15 In the ϕ **range** text field, type 270.
- 16 Find the **Sphere** subsection. From the **Sphere** list, choose **Manual**.
- 17 In the **Radius** text field, type 0.5.
- 18 Locate the **Coloring and Style** section. From the **Grid** list, choose **Fine**.
- 19 In the **Exterior-Field Sound Pressure Level (acpr)** toolbar, click  **Plot**.

Exterior-Field Sound Pressure Level (acpr)

- 1 In the **Model Builder** window, click **Exterior-Field Sound Pressure Level (acpr)**.
- 2 In the **Settings** window for **3D Plot Group**, locate the **Plot Settings** section.
- 3 Select the **Plot dataset edges** check box.
- 4 In the **Exterior-Field Sound Pressure Level (acpr)** toolbar, click  **Plot**.

5 Click the  **Show Grid** button in the **Graphics** toolbar.

The image should look like this.

harm_exc(3)=3 freq(47)=2360 Hz Radiation Pattern: Exterior-field sound pressure level (dB)

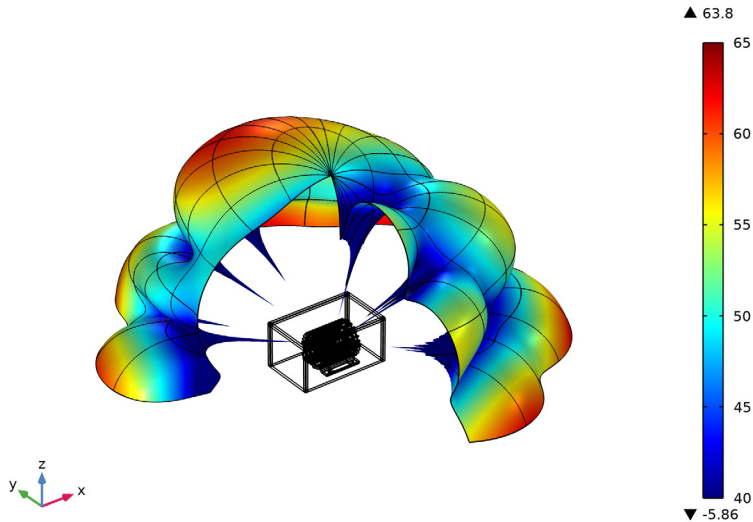

Campbell Diagram, First Microphone, Campbell Diagram, Second Microphone, Exterior-Field Sound Pressure Level (acpr)

1 In the **Model Builder** window, under **Results**, Ctrl-click to select **Campbell Diagram**, **First Microphone**, **Campbell Diagram**, **Second Microphone**, and **Exterior-Field Sound Pressure Level (acpr)**.

2 Right-click and choose **Group**.

Vibroacoustic Results - all Harmonics and Frequencies

In the **Settings** window for **Group**, type **Vibroacoustic Results - all Harmonics and Frequencies** in the **Label** text field.

Pressure - Revolutions - 1st Harmonic

1 In the **Results** toolbar, click  **Evaluation Group**.

2 In the **Settings** window for **Evaluation Group**, type **Pressure - Revolutions - 1st Harmonic** in the **Label** text field.

3 Locate the **Data** section. From the **Dataset** list, choose **Study 3 - Vibroacoustic Analysis - all Harmonics and Frequencies/Parametric Solutions 1 (sol5)**.

4 From the **Parameter selection (harm_exc)** list, choose **From list**.

- 5 In the **Parameter values (harm_exc)** list, select **1**.
- 6 Click to expand the **Format** section. From the **Include parameters** list, choose **Off**.

Global Evaluation 1

- 1 Right-click **Pressure - Revolutions - 1st Harmonic** and choose **Global Evaluation**.
- 2 In the **Settings** window for **Global Evaluation**, locate the **Expressions** section.
- 3 In the table, enter the following settings:

Expression	Unit	Description
rpm	RPM	Regime for the excited harmonic
subst(real(acpr.efc1.pext), x, 0.1[m], y, y_mic2, z, 0)	Pa	Absolute pressure at microphone 2 - Left Real
subst(imag(acpr.efc1.pext), x, 0.1[m], y, y_mic2, z, 0)	Pa	Absolute pressure at microphone 2 - Left Imag
subst(real(acpr.efc1.pext), x, -0.1[m], y, y_mic2, z, 0)	Pa	Absolute pressure at microphone 2 - Right Real
subst(imag(acpr.efc1.pext), x, -0.1[m], y, y_mic2, z, 0)	Pa	Absolute pressure at microphone 2 - Right Imag

- 4 In the **Pressure - Revolutions - 1st Harmonic** toolbar, click  **Evaluate**.

Pressure - Revolutions - 2nd Harmonic

- 1 In the **Model Builder** window, right-click **Pressure - Revolutions - 1st Harmonic** and choose **Duplicate**.
- 2 In the **Settings** window for **Evaluation Group**, type **Pressure - Revolutions - 2nd Harmonic** in the **Label** text field.
- 3 Locate the **Data** section. In the **Parameter values (harm_exc)** list, select **2**.
- 4 In the **Pressure - Revolutions - 2nd Harmonic** toolbar, click  **Evaluate**.

TABLE

Go to the **Table** window.

Pressure - Revolutions - 3rd Harmonic

- 1 Right-click **Pressure - Revolutions - 2nd Harmonic** and choose **Duplicate**.
- 2 In the **Settings** window for **Evaluation Group**, type **Pressure - Revolutions - 3rd Harmonic** in the **Label** text field.
- 3 Locate the **Data** section. In the **Parameter values (harm_exc)** list, select **3**.
- 4 In the **Pressure - Revolutions - 3rd Harmonic** toolbar, click  **Evaluate**.

5 Go to the **Table** window.

Pressure - Revolutions - 4th Harmonic

- 1 Right-click **Pressure - Revolutions - 3rd Harmonic** and choose **Duplicate**.
- 2 In the **Settings** window for **Evaluation Group**, type Pressure - Revolutions - 4th Harmonic in the **Label** text field.
- 3 Locate the **Data** section. In the **Parameter values (harm_exc)** list, select **4**.
- 4 In the **Pressure - Revolutions - 4th Harmonic** toolbar, click **= Evaluate**.
- 5 Go to the **Table** window.

Pressure - Revolutions - 5th Harmonic

- 1 Right-click **Pressure - Revolutions - 4th Harmonic** and choose **Duplicate**.
- 2 In the **Settings** window for **Evaluation Group**, type Pressure - Revolutions - 5th Harmonic in the **Label** text field.
- 3 Locate the **Data** section. In the **Parameter values (harm_exc)** list, select **5**.
- 4 In the **Pressure - Revolutions - 5th Harmonic** toolbar, click **= Evaluate**.
- 5 Go to the **Table** window.

Pressure - Revolutions - 6th Harmonic

- 1 Right-click **Pressure - Revolutions - 5th Harmonic** and choose **Duplicate**.
- 2 In the **Settings** window for **Evaluation Group**, type Pressure - Revolutions - 6th Harmonic in the **Label** text field.
- 3 Locate the **Data** section. In the **Parameter values (harm_exc)** list, select **6**.
- 4 In the **Pressure - Revolutions - 6th Harmonic** toolbar, click **= Evaluate**.
- 5 Go to the **Table** window.

Pressure - Revolutions - 7th Harmonic

- 1 Right-click **Pressure - Revolutions - 6th Harmonic** and choose **Duplicate**.
- 2 In the **Settings** window for **Evaluation Group**, type Pressure - Revolutions - 7th Harmonic in the **Label** text field.
- 3 Locate the **Data** section. In the **Parameter values (harm_exc)** list, select **7**.
- 4 In the **Pressure - Revolutions - 7th Harmonic** toolbar, click **= Evaluate**.

Pressure - Revolutions - 1st Harmonic, Pressure - Revolutions - 2nd Harmonic, Pressure - Revolutions - 3rd Harmonic, Pressure - Revolutions - 4th Harmonic, Pressure -

Revolutions - 5th Harmonic, Pressure - Revolutions - 6th Harmonic, Pressure - Revolutions - 7th Harmonic

- 1 In the **Model Builder** window, under **Results**, Ctrl-click to select **Pressure - Revolutions - 1st Harmonic, Pressure - Revolutions - 2nd Harmonic, Pressure - Revolutions - 3rd Harmonic, Pressure - Revolutions - 4th Harmonic, Pressure - Revolutions - 5th Harmonic, Pressure - Revolutions - 6th Harmonic,** and **Pressure - Revolutions - 7th Harmonic.**
- 2 Right-click and choose **Group.**

Acoustic Signal

In the **Settings** window for **Group**, type **Acoustic Signal** in the **Label** text field.

DEFINITIONS (COMP2)

In the **Model Builder** window, under **Component 2 (comp2)** click **Definitions.**

Interpolation 1 (int1)

- 1 In the **Home** toolbar, click  **Functions** and choose **Local>Interpolation.**
- 2 In the **Settings** window for **Interpolation**, locate the **Definition** section.
- 3 From the **Data source** list, choose **Result table.**
- 4 Find the **Functions** subsection. In the table, enter the following settings:

Function name	Position in file
real1_l	1
imag1_l	2
real1_r	3
imag1_r	4

- 5 Locate the **Interpolation and Extrapolation** section. From the **Interpolation** list, choose **Piecewise cubic.**
- 6 From the **Extrapolation** list, choose **Specific value.**
- 7 Locate the **Units** section. In the **Arguments** text field, type **RPM.**
- 8 In the **Function** text field, type **Pa.**
- 9 Click  **Plot.**

Interpolation 2 (real1_l, imag1_l, ...)

- 1 Right-click **Interpolation 1 (int1)** and choose **Duplicate.**
- 2 In the **Settings** window for **Interpolation**, locate the **Definition** section.
- 3 From the **Table from** list, choose **Pressure - Revolutions - 2nd Harmonic.**

4 Find the **Functions** subsection. In the table, enter the following settings:

Function name	Position in file
real2_l	1
imag2_l	2
real2_r	3
imag2_r	4

5 Click  **Plot**.

Interpolation 3 (real2_l, imag2_l, ...)

1 Right-click **Interpolation 2 (real1_l, imag1_l, ...)** and choose **Duplicate**.

2 In the **Settings** window for **Interpolation**, locate the **Definition** section.

3 From the **Table from** list, choose **Pressure - Revolutions - 3rd Harmonic**.

4 Find the **Functions** subsection. In the table, enter the following settings:

Function name	Position in file
real3_l	1
imag3_l	2
real3_r	3
imag3_r	4

5 Click  **Plot**.

Interpolation 4 (real3_l, imag3_l, ...)

1 Right-click **Interpolation 3 (real2_l, imag2_l, ...)** and choose **Duplicate**.

2 In the **Settings** window for **Interpolation**, locate the **Definition** section.

3 From the **Table from** list, choose **Pressure - Revolutions - 4th Harmonic**.

4 Find the **Functions** subsection. In the table, enter the following settings:

Function name	Position in file
real4_l	1
imag4_l	2
real4_r	3
imag4_r	4

5 Click  **Plot**.

Interpolation 5 (real4_l, imag4_l, ...)

- 1 Right-click **Interpolation 4 (real3_l, imag3_l, ...)** and choose **Duplicate**.
- 2 In the **Settings** window for **Interpolation**, locate the **Definition** section.
- 3 From the **Table from** list, choose **Pressure - Revolutions - 5th Harmonic**.
- 4 Find the **Functions** subsection. In the table, enter the following settings:

Function name	Position in file
real5_l	1
imag5_l	2
real5_r	3
imag5_r	4

- 5 Click  **Plot**.

Interpolation 6 (real5_l, imag5_l, ...)

- 1 Right-click **Interpolation 5 (real4_l, imag4_l, ...)** and choose **Duplicate**.
- 2 In the **Settings** window for **Interpolation**, locate the **Definition** section.
- 3 From the **Table from** list, choose **Pressure - Revolutions - 6th Harmonic**.
- 4 Find the **Functions** subsection. In the table, enter the following settings:

Function name	Position in file
real6_l	1
imag6_l	2
real6_r	3
imag6_r	4

- 5 Click  **Plot**.

Interpolation 7 (real6_l, imag6_l, ...)

- 1 Right-click **Interpolation 6 (real5_l, imag5_l, ...)** and choose **Duplicate**.
- 2 In the **Settings** window for **Interpolation**, locate the **Definition** section.
- 3 From the **Table from** list, choose **Pressure - Revolutions - 7th Harmonic**.
- 4 Find the **Functions** subsection. In the table, enter the following settings:

Function name	Position in file
real7_l	1
imag7_l	2

Function name	Position in file
real7_r	3
imag7_r	4

5 Click  **Plot**.

Interpolation 1 (real1_l, imag1_l, ...), Interpolation 2 (real2_l, imag2_l, ...), Interpolation 3 (real3_l, imag3_l, ...), Interpolation 4 (real4_l, imag4_l, ...), Interpolation 5 (real5_l, imag5_l, ...), Interpolation 6 (real6_l, imag6_l, ...), Interpolation 7 (real7_l, imag7_l, ...)

1 In the **Model Builder** window, under **Component 2 (comp2)>Definitions**, Ctrl-click to select **Interpolation 1 (real1_l, imag1_l, ...), Interpolation 2 (real2_l, imag2_l, ...), Interpolation 3 (real3_l, imag3_l, ...), Interpolation 4 (real4_l, imag4_l, ...), Interpolation 5 (real5_l, imag5_l, ...), Interpolation 6 (real6_l, imag6_l, ...), and Interpolation 7 (real7_l, imag7_l, ...)**.

2 Right-click and choose **Group**.

Acoustic Signal

In the **Settings** window for **Group**, type **Acoustic Signal** in the **Label** text field.

ROOT

In the **Home** toolbar, click  **Windows** and choose **Add Study**.

ADD STUDY

- 1 Go to the **Add Study** window.
- 2 Find the **Physics interfaces in study** subsection. In the table, clear the **Solve** check boxes for **Magnetic Fields (mf)** and **Weak Form Boundary PDE (wb)**.
- 3 Find the **Studies** subsection. In the **Select Study** tree, select **General Studies>Frequency Domain**.
- 4 Click **Add Study** in the window toolbar.
- 5 In the **Model Builder** window, click the root node.
- 6 In the **Home** toolbar, click  **Add Study** to close the **Add Study** window.

STUDY 4





Step 1: Frequency Domain

- 1 In the **Settings** window for **Frequency Domain**, locate the **Study Settings** section.
- 2 In the **Frequencies** text field, type 2360.
- 3 In the **Model Builder** window, click **Study 4**.

- 4 In the **Settings** window for **Study**, type **Study 4 - Vibroacoustic Analysis - 3rd Harmonic 2360 Hz** in the **Label** text field.
- 5 Locate the **Study Settings** section. Clear the **Generate default plots** check box.
- 6 Clear the **Generate convergence plots** check box.

Change the solver to a segregated solver, where the displacements will be obtained first and then used to compute the acoustic pressure.

Solution 13 (sol13)

- 1 In the **Study** toolbar, click  **Show Default Solver**.
- 2 In the **Model Builder** window, expand the **Solution 13 (sol13)** node.
- 3 In the **Model Builder** window, expand the **Study 4 - Vibroacoustic Analysis - 3rd Harmonic 2360 Hz>Solver Configurations>Solution 13 (sol13)>Stationary Solver I** node.
- 4 Right-click **Stationary Solver I** and choose **Segregated**.
- 5 In the **Settings** window for **Segregated**, locate the **General** section.
- 6 From the **Termination technique** list, choose **Iterations**.
- 7 In the **Model Builder** window, expand the **Study 4 - Vibroacoustic Analysis - 3rd Harmonic 2360 Hz>Solver Configurations>Solution 13 (sol13)>Stationary Solver I > Segregated I** node, then click **Segregated Step**.
- 8 In the **Settings** window for **Segregated Step**, locate the **General** section.
- 9 In the **Variables** list, select **Pressure (comp2.p)**.
- 10 Under **Variables**, click  **Delete**.
- 11 In the **Model Builder** window, right-click **Segregated I** and choose **Segregated Step**.
- 12 In the **Settings** window for **Segregated Step**, locate the **General** section.
- 13 Under **Variables**, click  **Add**.
- 14 In the **Add** dialog box, select **Pressure (comp2.p)** in the **Variables** list.
- 15 Click **OK**.
- 16 In the **Study** toolbar, click  **Compute**.

RESULTS

Study 4 - Vibroacoustic Analysis - 3rd Harmonic 2360 Hz/Solution 13 (sol13)

In the **Model Builder** window, under **Results>Datasets** right-click **Study 4 - Vibroacoustic Analysis - 3rd Harmonic 2360 Hz/Solution 13 (sol13)** and choose **Delete**.

Grid ID 1

- 1 In the **Results** toolbar, click  **More Datasets** and choose **Grid>Grid ID**.
- 2 In the **Settings** window for **Grid ID**, locate the **Data** section.
- 3 From the **Dataset** list, choose **Study 4 - Vibroacoustic Analysis - 3rd Harmonic 2360 Hz/ Solution 13 (sol13)**.
- 4 Locate the **Parameter Bounds** section. In the **Name** text field, type `tt`.
- 5 In the **Maximum** text field, type `20`.
- 6 Click to expand the **Resolution** section. In the **Resolution** text field, type `960000`.
- 7 Clear the **Adaptive** check box.

Acoustic Signal

- 1 In the **Results** toolbar, click  **ID Plot Group**.
- 2 In the **Settings** window for **ID Plot Group**, type `Acoustic Signal` in the **Label** text field.
- 3 Locate the **Data** section. From the **Dataset** list, choose **Grid ID 1**.
- 4 Locate the **Title** section. From the **Title type** list, choose **Label**.
- 5 Locate the **Plot Settings** section. Select the **y-axis label** check box.
- 6 In the associated text field, type `Signal (Pa)`.

Left Channel

- 1 Right-click **Acoustic Signal** and choose **Line Graph**.
- 2 In the **Settings** window for **Line Graph**, type `Left Channel` in the **Label** text field.
- 3 Locate the **y-Axis Data** section. Select the **Description** check box.
- 4 In the associated text field, type `Left Channel`.
- 5 In the **Expression** text field, type
$$\begin{aligned} & \text{real}(\text{real1_1}(\text{rev_ramp}(tt))+i* \\ & \text{imag1_1}(\text{rev_ramp}(tt))) * \exp(i*(\text{rev_ramp}(tt))*f0/\text{rpm0}*1*\pi*tt) + \\ & (\text{real2_1}(\text{rev_ramp}(tt))+i*\text{imag2_1}(\text{rev_ramp}(tt))) * \exp(i* \\ & (\text{rev_ramp}(tt))*f0/\text{rpm0}*2*\pi*tt) + (\text{real3_1}(\text{rev_ramp}(tt))+i* \\ & \text{imag3_1}(\text{rev_ramp}(tt))) * \exp(i*(\text{rev_ramp}(tt))*f0/\text{rpm0}*3*\pi*tt) + \\ & (\text{real4_1}(\text{rev_ramp}(tt))+i*\text{imag4_1}(\text{rev_ramp}(tt))) * \exp(i* \\ & (\text{rev_ramp}(tt))*f0/\text{rpm0}*4*\pi*tt) + (\text{real5_1}(\text{rev_ramp}(tt))+i* \\ & \text{imag5_1}(\text{rev_ramp}(tt))) * \exp(i*(\text{rev_ramp}(tt))*f0/\text{rpm0}*5*\pi*tt) + \\ & (\text{real6_1}(\text{rev_ramp}(tt))+i*\text{imag6_1}(\text{rev_ramp}(tt))) * \exp(i* \\ & (\text{rev_ramp}(tt))*f0/\text{rpm0}*6*\pi*tt) + (\text{real7_1}(\text{rev_ramp}(tt))+i* \\ & \text{imag7_1}(\text{rev_ramp}(tt))) * \exp(i*(\text{rev_ramp}(tt))*f0/\text{rpm0}*7*\pi*tt)). \end{aligned}$$
- 6 Locate the **x-Axis Data** section. From the **Parameter** list, choose **Expression**.

- 7 In the **Expression** text field, type `tt[s/m]`.
- 8 Select the **Description** check box.
- 9 In the associated text field, type `t ime`.
- 10 Click to expand the **Legends** section. Select the **Show legends** check box.
- 11 From the **Legends** list, choose **Manual**.
- 12 In the table, enter the following settings:

Legends
Left Channel

- 13 In the **Acoustic Signal** toolbar, click  **Plot**.

Right Channel

- 1 Right-click **Left Channel** and choose **Duplicate**.
- 2 In the **Settings** window for **Line Graph**, locate the **y-Axis Data** section.
- 3 In the **Description** text field, type `Right Channel`.
- 4 In the **Expression** text field, type `real((real1_r(rev_ramp(tt))+i*imag1_r(rev_ramp(tt)))*exp(i*(rev_ramp(tt))*f0/rpm0*1*pi*tt)+(real2_r(rev_ramp(tt))+i*imag2_r(rev_ramp(tt)))*exp(i*(rev_ramp(tt))*f0/rpm0*2*pi*tt)+(real3_r(rev_ramp(tt))+i*imag3_r(rev_ramp(tt)))*exp(i*(rev_ramp(tt))*f0/rpm0*3*pi*tt)+(real4_r(rev_ramp(tt))+i*imag4_r(rev_ramp(tt)))*exp(i*(rev_ramp(tt))*f0/rpm0*4*pi*tt)+(real5_r(rev_ramp(tt))+i*imag5_r(rev_ramp(tt)))*exp(i*(rev_ramp(tt))*f0/rpm0*5*pi*tt)+(real6_r(rev_ramp(tt))+i*imag6_r(rev_ramp(tt)))*exp(i*(rev_ramp(tt))*f0/rpm0*6*pi*tt)+(real7_r(rev_ramp(tt))+i*imag7_r(rev_ramp(tt)))*exp(i*(rev_ramp(tt))*f0/rpm0*7*pi*tt))`.
- 5 In the **Label** text field, type `Right Channel`.
- 6 Locate the **Legends** section. In the table, enter the following settings:

Legends
Right Channel

7 In the **Acoustic Signal** toolbar, click  **Plot**.

The image should look like this.

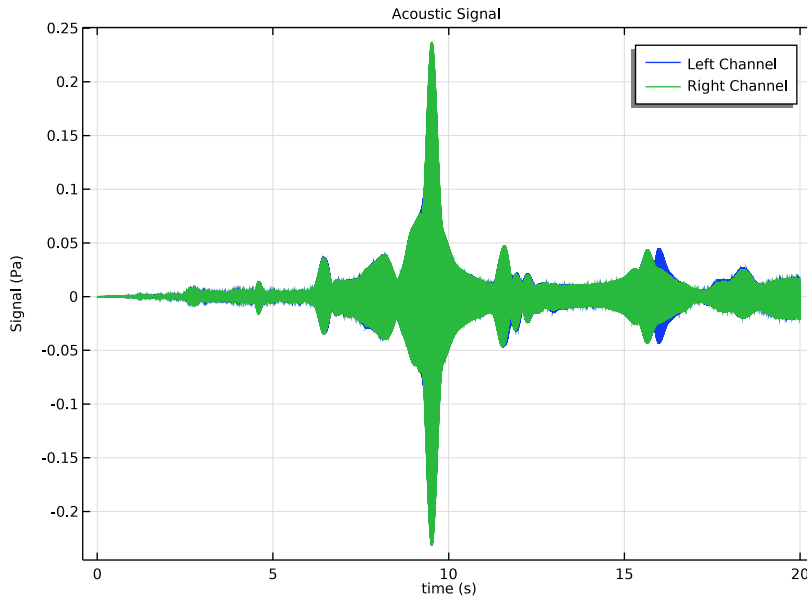

Left Channel Acoustic Signal

- 1 In the **Model Builder** window, under **Results>Vibroacoustic Results - all Harmonics and Frequencies>Acoustic Signal** right-click **Left Channel** and choose **Add Plot Data to Export**.
- 2 In the **Settings** window for **Plot**, type **Left Channel Acoustic Signal** in the **Label** text field.
- 3 Locate the **Output** section. From the **File type** list, choose **WAVE audio file (*.wav)**.
- 4 In the **Filename** text field, type **electric_motor_noise_left.wav**.
Click on export to produce a wav file with the acoustic signal at the left channel.

Right Channel Acoustic Signal

- 1 In the **Model Builder** window, under **Results>Vibroacoustic Results - all Harmonics and Frequencies>Acoustic Signal** right-click **Right Channel** and choose **Add Plot Data to Export**.
- 2 In the **Settings** window for **Plot**, type **Right Channel Acoustic Signal** in the **Label** text field.
- 3 Locate the **Output** section. From the **File type** list, choose **WAVE audio file (*.wav)**.

- 4 In the **Filename** text field, type `electric_motor_noise_right.wav`.
Click on **export** to produce a wav file with the acoustic signal at the right channel.

Displacement and acoustic pressure

- 1 In the **Home** toolbar, click  **Add Plot Group** and choose **3D Plot Group**.
- 2 In the **Settings** window for **3D Plot Group**, type **Displacement and acoustic pressure** in the **Label** text field.
- 3 Locate the **Data** section. From the **Dataset** list, choose **Study 4 - Vibroacoustic Analysis - 3rd Harmonic 2360 Hz/Solution 13 (sol13)**.
- 4 Locate the **Plot Settings** section. Clear the **Plot dataset edges** check box.
- 5 Locate the **Color Legend** section. Select the **Show maximum and minimum values** check box.

Surface 1

- 1 Right-click **Displacement and acoustic pressure** and choose **Surface**.
- 2 In the **Settings** window for **Surface**, locate the **Expression** section.
- 3 In the **Expression** text field, type `solid.disp`.

Deformation 1

Right-click **Surface 1** and choose **Deformation**.

Filter 1

- 1 In the **Model Builder** window, right-click **Surface 1** and choose **Filter**.
- 2 In the **Settings** window for **Filter**, locate the **Element Selection** section.
- 3 In the **Logical expression for inclusion** text field, type `x > -40.5 [mm]`.
- 4 In the **Displacement and acoustic pressure** toolbar, click  **Plot**.

Line 1

- 1 In the **Model Builder** window, right-click **Displacement and acoustic pressure** and choose **Line**.
- 2 In the **Settings** window for **Line**, locate the **Expression** section.
- 3 In the **Expression** text field, type `0`.
- 4 Click to expand the **Title** section. From the **Title type** list, choose **None**.
- 5 Locate the **Coloring and Style** section. From the **Coloring** list, choose **Uniform**.
- 6 From the **Color** list, choose **Black**.

Deformation 1

In the **Model Builder** window, right-click **Deformation 1** and choose **Copy**.

Deformation 1

In the **Model Builder** window, right-click **Line 1** and choose **Paste Deformation**.

Filter 1

In the **Model Builder** window, right-click **Filter 1** and choose **Copy**.

Filter 1

In the **Model Builder** window, right-click **Line 1** and choose **Paste Filter**.

Line 1

- 1 In the **Settings** window for **Line**, click to expand the **Inherit Style** section.
- 2 From the **Plot** list, choose **Surface 1**.
- 3 Clear the **Color** check box.
- 4 Clear the **Color and data range** check box.
- 5 In the **Displacement and acoustic pressure** toolbar, click  **Plot**.

Isosurface 1

- 1 In the **Model Builder** window, right-click **Displacement and acoustic pressure** and choose **Isosurface**.
- 2 In the **Settings** window for **Isosurface**, locate the **Levels** section.
- 3 In the **Total levels** text field, type 11.
- 4 Locate the **Coloring and Style** section. From the **Color table** list, choose **Wave**.
- 5 Select the **Symmetrize color range** check box.

Selection 1

- 1 Right-click **Isosurface 1** and choose **Selection**.
- 2 Select Domain 9 only.

Filter 1

In the **Model Builder** window, right-click **Filter 1** and choose **Copy**.

Filter 1

In the **Model Builder** window, right-click **Isosurface 1** and choose **Paste Filter**.

Displacement and acoustic pressure

- 1 In the **Displacement and acoustic pressure** toolbar, click  **Plot**.

The image should look like [Figure 11](#).

SPL and Radiation Pattern

- 1 In the **Home** toolbar, click  **Add Plot Group** and choose **3D Plot Group**.

- 2 In the **Settings** window for **3D Plot Group**, type SPL and Radiation Pattern in the **Label** text field.
- 3 Locate the **Data** section. From the **Dataset** list, choose **Study 4 - Vibroacoustic Analysis - 3rd Harmonic 2360 Hz/Solution 13 (sol13)**.
- 4 Click to expand the **Selection** section. From the **Geometric entity level** list, choose **Domain**.
- 5 From the **Selection** list, choose **Structure**.
- 6 Locate the **Plot Settings** section. Clear the **Plot dataset edges** check box.

Surface 1

- 1 Right-click **SPL and Radiation Pattern** and choose **Surface**.
- 2 In the **Settings** window for **Surface**, locate the **Expression** section.
- 3 In the **Expression** text field, type `acpr.Lp`.
- 4 Click to expand the **Range** section. Select the **Manual color range** check box.
- 5 In the **Minimum** text field, type 50.
- 6 In the **Maximum** text field, type 85.

Deformation 1

Right-click **Surface 1** and choose **Deformation**.

Line 1

- 1 In the **Model Builder** window, right-click **SPL and Radiation Pattern** and choose **Line**.
- 2 In the **Settings** window for **Line**, locate the **Expression** section.
- 3 In the **Expression** text field, type 0.
- 4 Locate the **Title** section. From the **Title type** list, choose **None**.
- 5 Locate the **Coloring and Style** section. From the **Coloring** list, choose **Uniform**.
- 6 From the **Color** list, choose **Black**.
- 7 Locate the **Inherit Style** section. From the **Plot** list, choose **Surface 1**.
- 8 Clear the **Color** check box.
- 9 Clear the **Color and data range** check box.

Deformation 1

Right-click **Line 1** and choose **Deformation**.

Radiation Pattern 1

- 1 In the **Model Builder** window, expand the **Results>Vibroacoustic Results - all Harmonics and Frequencies>Exterior-Field Sound Pressure Level (acpr)** node.

- 2 Right-click **Radiation Pattern 1** and choose **Copy**.

Radiation Pattern 1

- 1 In the **Model Builder** window, right-click **SPL and Radiation Pattern** and choose **Paste Radiation Pattern**.
- 2 In the **Settings** window for **Radiation Pattern**, locate the **Evaluation** section.
- 3 Find the **Angles** subsection. In the ϕ **range** text field, type 360.

Transparency 1

- 1 Right-click **Radiation Pattern 1** and choose **Transparency**.
- 2 Click the  **Zoom Extents** button in the **Graphics** toolbar.
The image should look like [Figure 12](#).

Boundary Loads



- 1 In the **Home** toolbar, click  **Add Plot Group** and choose **3D Plot Group**.
- 2 In the **Settings** window for **3D Plot Group**, type Boundary Loads in the **Label** text field.
- 3 Locate the **Data** section. From the **Dataset** list, choose **Study 4 - Vibroacoustic Analysis - 3rd Harmonic 2360 Hz/Solution 13 (sol13)**.
- 4 Locate the **Selection** section. From the **Geometric entity level** list, choose **Domain**.
- 5 From the **Selection** list, choose **Structure**.
- 6 Select the **Apply to dataset edges** check box.

Arrow Surface 1

- 1 Right-click **Boundary Loads** and choose **Arrow Surface**.
- 2 In the **Settings** window for **Arrow Surface**, locate the **Expression** section.
- 3 In the **X component** text field, type `solid.bnd11.F_Ax`.
- 4 In the **Y component** text field, type `solid.bnd11.F_Ay`.
- 5 In the **Z component** text field, type `solid.bnd11.F_Az`.
- 6 Locate the **Arrow Positioning** section. From the **Placement** list, choose **Gauss points**.

Color Expression 1

- 1 Right-click **Arrow Surface 1** and choose **Color Expression**.
- 2 In the **Settings** window for **Color Expression**, locate the **Expression** section.
- 3 In the **Expression** text field, type `comp2.solid.bnd11.F_A_Mag`.
- 4 Locate the **Coloring and Style** section. From the **Coloring** list, choose **Gradient**.
- 5 From the **Top color** list, choose **Red**.

- 6 Click the  **Orthographic Projection** button in the **Graphics** toolbar.
- 7 Click the  **Go to YZ View** button in the **Graphics** toolbar.

The image should look like [Figure 10](#).

Boundary Loads, Displacement and acoustic pressure, SPL and Radiation Pattern

- 1 In the **Model Builder** window, under **Results**, Ctrl-click to select **Displacement and acoustic pressure, SPL and Radiation Pattern**, and **Boundary Loads**.
- 2 Right-click and choose **Group**.

Vibroacoustic Results - 3rd Harmonic 2360 Hz

In the **Settings** window for **Group**, type **Vibroacoustic Results - 3rd Harmonic 2360 Hz** in the **Label** text field.



Geometry Sequence Instructions

From the **File** menu, choose **New**.

NEW

In the **New** window, click  **Model Wizard**.

MODEL WIZARD

- 1 In the **Model Wizard** window, click  **3D**.
- 2 Click  **Done**.

GLOBAL DEFINITIONS

Parameters 1

- 1 In the **Model Builder** window, under **Global Definitions** click **Parameters 1**.
- 2 In the **Settings** window for **Parameters**, locate the **Parameters** section.
- 3 Click  **Load from File**.
- 4 Browse to the model's Application Libraries folder and double-click the file `electric_motor_noise_pmsm_geom_sequence_parameters.txt`.



GEOMETRY 1

Import 1 (impl)

- 1 In the **Home** toolbar, click  **Import**.

- 2 In the **Settings** window for **Import**, locate the **Import** section.
- 3 From the **Source** list, choose **COMSOL Multiphysics file**.
- 4 Click **Browse**.
- 5 Browse to the model's Application Libraries folder and double-click the file `electric_motor_noise_psmm_geom_sequence.mphbin`.
- 6 Click **Import**.
- 7 Click the  **Wireframe Rendering** button in the **Graphics** toolbar.

Work Plane 1 (wp1)

- 1 In the **Geometry** toolbar, click  **Work Plane**.
- 2 In the **Settings** window for **Work Plane**, locate the **Plane Definition** section.
- 3 From the **Plane** list, choose **yz-plane**.
- 4 From the **Offset type** list, choose **Through vertex**.
- 5 Find the **Offset vertex** subsection. Select the  **Activate Selection** toggle button.
- 6 On the object **imp1**, select Point 372 only.

Work Plane 1 (wp1)>Plane Geometry

In the **Model Builder** window, click **Plane Geometry**.

Work Plane 1 (wp1)>Circle 1 (c1)

- 1 In the **Work Plane** toolbar, click  **Circle**.
- 2 In the **Settings** window for **Circle**, locate the **Size and Shape** section.
- 3 In the **Radius** text field, type `r_stator`.
- 4 Click to expand the **Layers** section. In the table, enter the following settings:

Layer name	Thickness (m)
Layer 1	<code>th_out_stator</code>
Layer 2	<code>h_stat-th_out_stator</code>
Layer 3	<code>air_gap/2</code>

- 5 Click  **Build Selected**.

Work Plane 1 (wp1)>Polygon 1 (pol1)

- 1 In the **Work Plane** toolbar, click  **Polygon**.
- 2 In the **Settings** window for **Polygon**, locate the **Coordinates** section.

3 In the table, enter the following settings:

xw (m)	yw (m)
$(r_{\text{stator}}-h_{\text{stat}}+th_{\text{in_stator}})$	0
$(r_{\text{stator}}-h_{\text{stat}}+th_{\text{in_stator}}+h_{\text{coil_angle}})*\cos(-\text{angle_coil}/2)$	$(r_{\text{stator}}-h_{\text{stat}}+th_{\text{in_stator}}+h_{\text{coil_angle}})*\sin(-\text{angle_coil}/2)$
$(r_{\text{stator}}-th_{\text{out_stator}})*\cos(-\text{angle_coil}/2)$	$(r_{\text{stator}}-th_{\text{out_stator}})*\sin(-\text{angle_coil}/2)$
$(r_{\text{stator}}-th_{\text{out_stator}}/2)$	0
$(r_{\text{stator}}-th_{\text{out_stator}})*\cos(\text{angle_coil}/2)$	$(r_{\text{stator}}-th_{\text{out_stator}})*\sin(\text{angle_coil}/2)$
$(r_{\text{stator}}-h_{\text{stat}}+th_{\text{in_stator}}+h_{\text{coil_angle}})*\cos(\text{angle_coil}/2)$	$(r_{\text{stator}}-h_{\text{stat}}+th_{\text{in_stator}}+h_{\text{coil_angle}})*\sin(\text{angle_coil}/2)$

4 Click  **Build Selected.**

Work Plane 1 (wp1)>Polygon 2 (pol2)

1 In the **Work Plane** toolbar, click  **Polygon.**

2 In the **Settings** window for **Polygon**, locate the **Coordinates** section.

3 In the table, enter the following settings:

xw (m)	yw (m)
$(r_{\text{stator}}-h_{\text{stat}})*\cos(-\text{angle_teeth_gap}/2)$	$(r_{\text{stator}}-h_{\text{stat}})*\sin(-\text{angle_teeth_gap}/2)$
$(r_{\text{stator}}-th_{\text{out_stator}})*\cos(-\text{angle_teeth_gap}/2)$	$(r_{\text{stator}}-th_{\text{out_stator}})*\sin(-\text{angle_teeth_gap}/2)$
$(r_{\text{stator}}-th_{\text{out_stator}})*\cos(+\text{angle_teeth_gap}/2)$	$(r_{\text{stator}}-th_{\text{out_stator}})*\sin(+\text{angle_teeth_gap}/2)$
$(r_{\text{stator}}-h_{\text{stat}})*\cos(+\text{angle_teeth_gap}/2)$	$(r_{\text{stator}}-h_{\text{stat}})*\sin(+\text{angle_teeth_gap}/2)$

4 Click  **Build Selected.**

Work Plane 1 (wp1)>Union 1 (uni1)

1 In the **Work Plane** toolbar, click  **Booleans and Partitions** and choose **Union.**

2 Select the objects **pol1** and **pol2** only.

3 In the **Settings** window for **Union**, click  **Build Selected.**

Work Plane 1 (wp1)>Delete Entities 1 (del1)

1 Right-click **Plane Geometry** and choose **Delete Entities.**

2 On the object **c1**, select Boundaries 1–12 only.

3 On the object **uni1**, select Boundaries 1, 4, 5, and 12–14 only.

4 In the **Settings** window for **Delete Entities**, click  **Build Selected**.

Work Plane 1 (wp1)>Rotate 1 (rot1)

1 In the **Work Plane** toolbar, click  **Transforms** and choose **Rotate**.

2 Select the object **del1(2)** only.

3 In the **Settings** window for **Rotate**, locate the **Rotation** section.

4 In the **Angle** text field, type range (360 / (3*n_sectors) , 360 / (3*n_sectors) , 360).

5 Click  **Build Selected**.

Work Plane 1 (wp1)>Union 2 (uni2)

1 In the **Work Plane** toolbar, click  **Booleans and Partitions** and choose **Union**.

2 Click in the **Graphics** window and then press Ctrl+A to select all objects.

3 In the **Settings** window for **Union**, click  **Build Selected**.

Work Plane 1 (wp1)>Delete Entities 2 (del2)

1 Right-click **Plane Geometry** and choose **Delete Entities**.

2 On the object **uni2**, select Boundaries 75, 76, 83, 84, 91, 92, 99–102, 113, 114, 121–124, 127, 128, 135, and 136 only.

3 In the **Settings** window for **Delete Entities**, click  **Build Selected**.

Work Plane 1 (wp1)>Delete Entities 3 (del3)

1 Right-click **Plane Geometry** and choose **Delete Entities**.

2 In the **Settings** window for **Delete Entities**, locate the **Entities or Objects to Delete** section.

3 From the **Geometric entity level** list, choose **Domain**.

4 On the object **del2**, select Domain 21 only.

5 Click  **Build Selected**.

Work Plane 1 (wp1)>Fillet 1 (fil1)

1 In the **Work Plane** toolbar, click  **Fillet**.

2 On the object **del3**, select Points 22–25, 38–41, 54, 55, 58, 59, 70–73, 81, and 82 only.

3 In the **Settings** window for **Fillet**, locate the **Radius** section.



4 In the **Radius** text field, type fillet.

5 Click  **Build Selected**.



Extrude 1 (ext1)

- 1 In the **Model Builder** window, under **Component 1 (comp1)>Geometry 1** right-click **Work Plane 1 (wp1)** and choose **Extrude**.
- 2 In the **Settings** window for **Extrude**, locate the **Distances** section.
- 3 From the **Specify** list, choose **Vertices to extrude to**.
- 4 On the object **imp1**, select Point 490 only.
- 5 Click  **Build Selected**.

Union 1 (uni1)

- 1 In the **Geometry** toolbar, click  **Booleans and Partitions** and choose **Union**.
- 2 Click in the **Graphics** window and then press Ctrl+A to select both objects.
- 3 In the **Settings** window for **Union**, click  **Build Selected**.

Work Plane 2 (wp2)

- 1 In the **Geometry** toolbar, click  **Work Plane**.
- 2 In the **Settings** window for **Work Plane**, locate the **Plane Definition** section.
- 3 From the **Plane** list, choose **yz-plane**.
- 4 From the **Offset type** list, choose **Through vertex**.
- 5 Find the **Offset vertex** subsection. Select the  **Activate Selection** toggle button.
- 6 On the object **uni1**, select Point 422 only.

Work Plane 2 (wp2)>Plane Geometry

In the **Model Builder** window, click **Plane Geometry**.



Work Plane 2 (wp2)>Circle 1 (c1)

- 1 In the **Work Plane** toolbar, click  **Circle**.
- 2 In the **Settings** window for **Circle**, locate the **Size and Shape** section.
- 3 In the **Radius** text field, type $r_{\text{stator}} - h_{\text{stat}} - \text{air_gap}/2$.
- 4 Locate the **Layers** section. In the table, enter the following settings:



Layer name	Thickness (m)
Layer 1	air_gap/2
Layer 2	th_magnet
Layer 3	$r_{\text{stator}} - h_{\text{stat}} - \text{air_gap} - \text{th_magnet} - r_{\text{shaft}}$

- 5 Click  **Build Selected**.



Work Plane 2 (wp2)>Line Segment 1 (ls1)

- 1 In the **Work Plane** toolbar, click  **More Primitives** and choose **Line Segment**.
- 2 In the **Settings** window for **Line Segment**, locate the **Starting Point** section.
- 3 From the **Specify** list, choose **Coordinates**.
- 4 In the **xw** text field, type $(r_stator-h_stat-air_gap-th_magnet) * \cos(-angle_magnet/2)$.
- 5 In the **yw** text field, type $(r_stator-h_stat-air_gap-th_magnet) * \sin(-angle_magnet/2)$.
- 6 Locate the **Endpoint** section. From the **Specify** list, choose **Coordinates**.
- 7 In the **xw** text field, type $(r_stator-h_stat-air_gap) * \cos(-angle_magnet/2)$.
- 8 In the **yw** text field, type $(r_stator-h_stat-air_gap) * \sin(-angle_magnet/2)$.
- 9 Click  **Build Selected**.

Work Plane 2 (wp2)>Rotate 1 (rot1)

- 1 In the **Work Plane** toolbar, click  **Transforms** and choose **Rotate**.
- 2 Select the object **ls1** only.
- 3 In the **Settings** window for **Rotate**, locate the **Rotation** section.
- 4 In the **Angle** text field, type $range(360/(n_poles), 360/(n_poles), 360) range(360/(n_poles)+angle_magnet, 360/(n_poles), 360+angle_magnet)$.
- 5 Click  **Build Selected**.

Work Plane 2 (wp2)>Union 1 (uni1)

- 1 In the **Work Plane** toolbar, click  **Booleans and Partitions** and choose **Union**.
- 2 Select the object **cl** only.
- 3 Click the  **Select All** button in the **Graphics** toolbar.
- 4 In the **Settings** window for **Union**, click  **Build Selected**.

Work Plane 2 (wp2)>Delete Entities 1 (del1)

- 1 Right-click **Plane Geometry** and choose **Delete Entities**.
- 2 On the object **uni1**, select Boundaries 1, 2, 5, 10–15, 18, 23, 24, 27, 28, 35, 36, 57, 58, 63, and 64 only.
- 3 In the **Settings** window for **Delete Entities**, click  **Build Selected**.

Work Plane 2 (wp2)>Fillet 1 (fil1)



- 1 In the **Work Plane** toolbar, click  **Fillet**.
- 2 On the object **del1**, select Points 2, 3, 7–10, 29–32, 36, and 37 only.

- 3 In the **Settings** window for **Fillet**, locate the **Radius** section.
- 4 In the **Radius** text field, type `fillet`.
- 5 Click  **Build Selected**.

Extrude 2 (ext2)

- 1 In the **Model Builder** window, under **Component 1 (comp1)>Geometry 1** right-click **Work Plane 2 (wp2)** and choose **Extrude**.
- 2 In the **Settings** window for **Extrude**, locate the **Distances** section.
- 3 From the **Specify** list, choose **Vertices to extrude to**.
- 4 On the object **uni1**, select Point 656 only.
- 5 Click  **Build Selected**.

Work Plane 3 (wp3)

- 1 In the **Geometry** toolbar, click  **Work Plane**.
- 2 In the **Settings** window for **Work Plane**, locate the **Plane Definition** section.
- 3 From the **Plane** list, choose **yz-plane**.
- 4 Click  **Build Selected**.

Form Union (fin)

- 1 In the **Model Builder** window, under **Component 1 (comp1)>Geometry 1** click **Form Union (fin)**.
- 2 In the **Settings** window for **Form Union/Assembly**, locate the **Form Union/Assembly** section.
- 3 From the **Action** list, choose **Form an assembly**.
- 4 In the **Geometry** toolbar, click  **Build All**.

Iron

- 1 In the **Geometry** toolbar, click  **Selections** and choose **Explicit Selection**.
- 2 In the **Settings** window for **Explicit Selection**, type `Iron` in the **Label** text field.
- 3 On the object **fin**, select Domains 13, 24, 49, and 60–67 only.

Coils

- 1 In the **Geometry** toolbar, click  **Selections** and choose **Explicit Selection**.
- 2 In the **Settings** window for **Explicit Selection**, type `Coils` in the **Label** text field.
- 3 On the object **fin**, select Domains 25, 26, and 28–43 only.

Aluminum

- 1 In the **Geometry** toolbar, click  **Selections** and choose **Explicit Selection**.

- 2 In the **Settings** window for **Explicit Selection**, type Aluminum in the **Label** text field.
- 3 On the object **fin**, select Domains 14–17, 19–23, 44–47, and 50–52 only.

Structure

- 1 In the **Geometry** toolbar, click  **Selections** and choose **Union Selection**.
- 2 In the **Settings** window for **Union Selection**, type Structure in the **Label** text field.
- 3 Locate the **Input Entities** section. Click **+ Add**.
- 4 In the **Add** dialog box, in the **Selections to add** list, choose **Iron, Coils**, and **Aluminum**.
- 5 Click **OK**.

Interior Cavity

- 1 In the **Geometry** toolbar, click  **Selections** and choose **Explicit Selection**.
- 2 In the **Settings** window for **Explicit Selection**, type Interior Cavity in the **Label** text field.
- 3 On the object **fin**, select Domains 18, 27, 48, and 59 only.

PML

- 1 In the **Geometry** toolbar, click  **Selections** and choose **Explicit Selection**.
- 2 In the **Settings** window for **Explicit Selection**, type PML in the **Label** text field.
- 3 On the object **fin**, select Domains 1–8, 10–12, and 53–58 only.

Air

- 1 In the **Geometry** toolbar, click  **Selections** and choose **Complement Selection**.
- 2 In the **Settings** window for **Complement Selection**, type Air in the **Label** text field.
- 3 Locate the **Input Entities** section. Click **+ Add**.
- 4 In the **Add** dialog box, in the **Selections to invert** list, choose **Structure** and **Interior Cavity**.
- 5 Click **OK**.

Loaded Boundaries

- 1 In the **Geometry** toolbar, click  **Selections** and choose **Explicit Selection**.
- 2 In the **Settings** window for **Explicit Selection**, type Loaded Boundaries in the **Label** text field.
- 3 Locate the **Entities to Select** section. From the **Geometric entity level** list, choose **Boundary**.
- 4 On the object **fin**, select Boundaries 335, 336, 338, 339, 347, 349, 352, 355, 359, 360, 366, 367, 371, 372, 374, 375, 377, 378, 380–385, 389–394, 396, 398, 401, 402, 404, 407, 413–422, 425–428, 438–441, 444, 446–448, 450, 451, 456, 457, 460–463, 466,

469–477, 486–495, 497, 498, 500, 501, 506, 509, 514–517, 520, 521, 523, 524, 526, 529, 532–537, 553–556, 950, 951, 953–956, 958, 959, 962–965, 967, 968, 970–975, 977, 978, 982, 984, 985, 987, 989–992, 994, 997, and 999–1010 only.

Exterior Field Calculation

- 1 In the **Geometry** toolbar, click  **Selections** and choose **Explicit Selection**.
- 2 In the **Settings** window for **Explicit Selection**, type Exterior Field Calculation in the **Label** text field.
- 3 Locate the **Entities to Select** section. From the **Geometric entity level** list, choose **Boundary**.
- 4 On the object **fin**, select Boundaries 31, 32, 36, 39, and 924 only.

Fixed Boundaries

- 1 In the **Geometry** toolbar, click  **Selections** and choose **Explicit Selection**.
- 2 In the **Settings** window for **Explicit Selection**, type Fixed Boundaries in the **Label** text field.
- 3 Locate the **Entities to Select** section. From the **Geometric entity level** list, choose **Boundary**.
- 4 On the object **fin**, select Boundaries 213, 214, 217, 247, 249, 257, 291, 292, 294–297, 299, 300, 581, 582, 597, 690, 692, 719, 725, 726, 728–731, 733, and 734 only.

Meshed Section

- 1 In the **Geometry** toolbar, click  **Selections** and choose **Explicit Selection**.
- 2 In the **Settings** window for **Explicit Selection**, type Meshed Section in the **Label** text field.
- 3 Locate the **Entities to Select** section. From the **Geometric entity level** list, choose **Boundary**.
- 4 On the object **fin**, select Boundaries 301, 306, 317, 331, 334, 337, 346, 351, 354, 376, 379, 386, 403, 406, 431, 437, 445, 464, 467, 496, 499, 505, 508, 525, 528, 538, 946, 949, 952, 957, 966, 969, 976, 993, and 996 only.

Sweep Domain

- 1 In the **Geometry** toolbar, click  **Selections** and choose **Explicit Selection**.
- 2 In the **Settings** window for **Explicit Selection**, type Sweep Domain in the **Label** text field.
- 3 On the object **fin**, select Domains 13, 21–44, 49, and 59–67 only.

Tetrahedral Domains

- 1 In the **Geometry** toolbar, click  **Selections** and choose **Complement Selection**.

- 2 In the **Settings** window for **Complement Selection**, type Tetrahedral Domains in the **Label** text field.
- 3 Locate the **Input Entities** section. Click **+ Add**.
- 4 In the **Add** dialog box, in the **Selections to invert** list, choose **Interior Cavity**, **PML**, and **Sweep Domain**.
- 5 Click **OK**.