



# Frequency Domain Study of Three-Phase Motor

## Introduction

---

This verification application is based on the first case detailed in the TEAM benchmark problem 30, “Induction Motor Analyses” (Ref. 1). The application performs a frequency domain analysis of a simple three-phase induction motor in 2D, with a circularly-symmetric rotor made of aluminum and iron. The solution is compared with analytic results; in particular, the torque, coil voltage, and losses are evaluated as functions of the rotational speed.

## Model Definition

---

The model geometry is two-dimensional and is represented in Figure 1. This simplified geometry was chosen in Ref. 1 to allow computing the analytic solution to use as a reference for the numerical results.

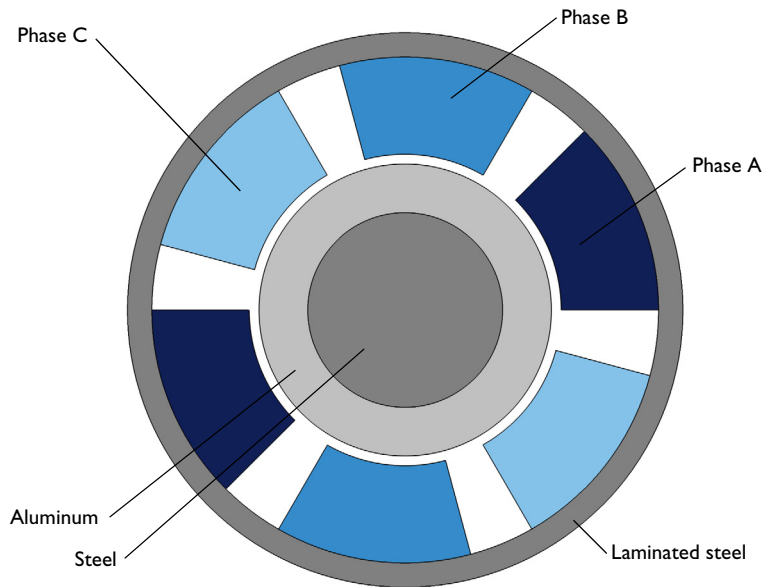

*Figure 1: Two-dimensional geometry of the three-phase induction motor.*

The rotor consists of an iron core surrounded by an aluminum layer. The air gap and the region containing the six coils (windings), including the coil themselves, are nonmagnetic and nonconductive. The motor is surrounded by a layer of laminated iron and the outer region is air.

The rotating part is rotationally symmetric and it does not have magnetic sources (such as permanent magnets), so the rotation can be modeled by adding an artificial term (Lorentz's term) to the constitutive relation for the conduction current:

$$\mathbf{J} = \sigma(\mathbf{E} + \mathbf{v} \times \mathbf{B}) \quad (1)$$

where  $\mathbf{v}$  is the local velocity of the material. The properties of the rotor and the constant rotational velocity ensure that all the fields and currents in the model are time-harmonic; so a frequency-domain analysis can be performed.

Using Lorentz's term and a frequency-domain analysis allows setting up a numerical problem without the need for moving meshes, as it is normally done with the **Rotating Machinery, Magnetic** interface. The **Magnetic Fields** interface can be used instead. The Lorentz's term is added by using a **Velocity (Lorentz's Term)** feature.

The three-phase coils (windings) are modeled with three **Coil** features using the **Homogenized multiturn** conductor model, which provide a homogenized model of bundles of tiny conducting wires. The three Coils use the **Coil group** functionality to model the two series-connected phase groups with current flowing in opposite direction.

The quantities of interests, for which analytic data is provided in Ref, are:

- the torque at different rotational speeds, computed using a **Force Calculation** feature,
- the coil voltage, computed automatically by the Coil features,
- the losses in the rotor, computed by integrating the power loss density.

## Results and Discussion

Figure 2 and Figure 3 show the axial current density and the magnetic flux density lines for two different angular velocities,  $\Omega = 200$  rad/s and  $\Omega = 800$  rad/s, respectively, below and above the rotational velocity of the stator field (about 377 rad/s or 3600 RPM).

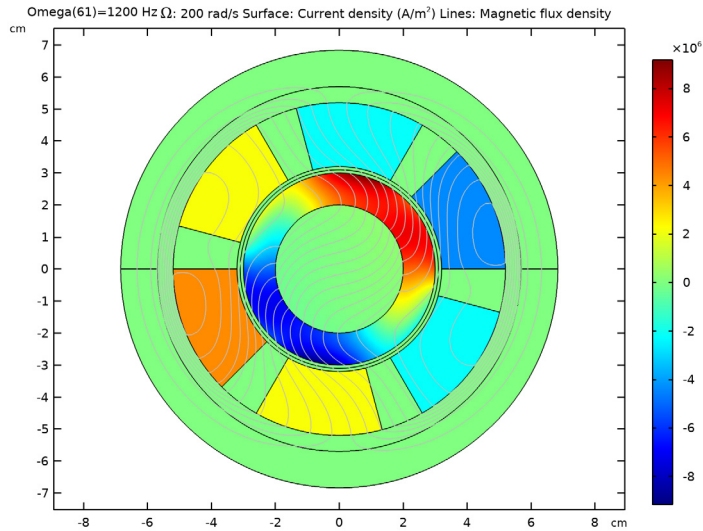

Figure 2: Axial current density and magnetic flux density lines for  $\Omega = 200$  rad/s.

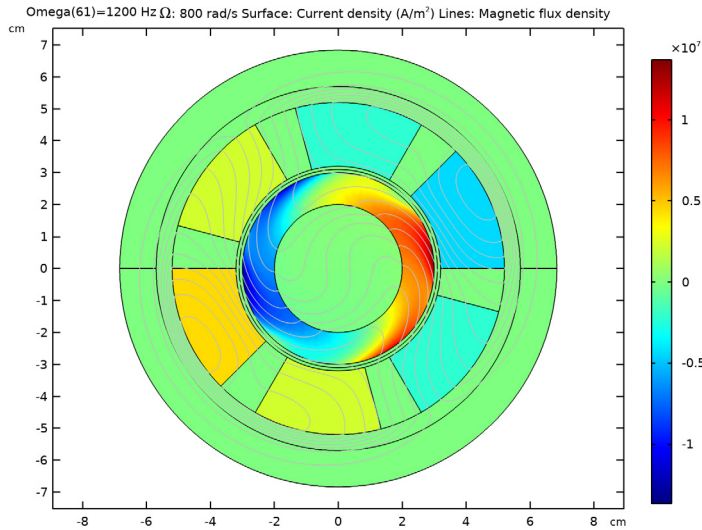

Figure 3: Axial induced current density and magnetic flux density lines for  $\Omega = 800$  rad/s.

Since the analysis performed is in the frequency domain, the solutions plotted in Figure 2 and Figure 3 are the real part of the current density and magnetic flux density phasors. It is possible to visualize the evolution of the fields during a cycle by changing the value of the phase in the dataset or by creating an animation as demonstrated in the application.

Figure 4, Figure 5, and Figure 6 show the computed torque, the coil voltage, and the rotor losses as a function of the rotational velocity. The plots show the expected results for an induction motor; in particular, the torque is zero, the voltage is maximum, and the losses are at a minimum at the synchronous speed ( $\Omega = 377$  rad/s).

The computed solution shows very good agreement with the analytic data (green markers).

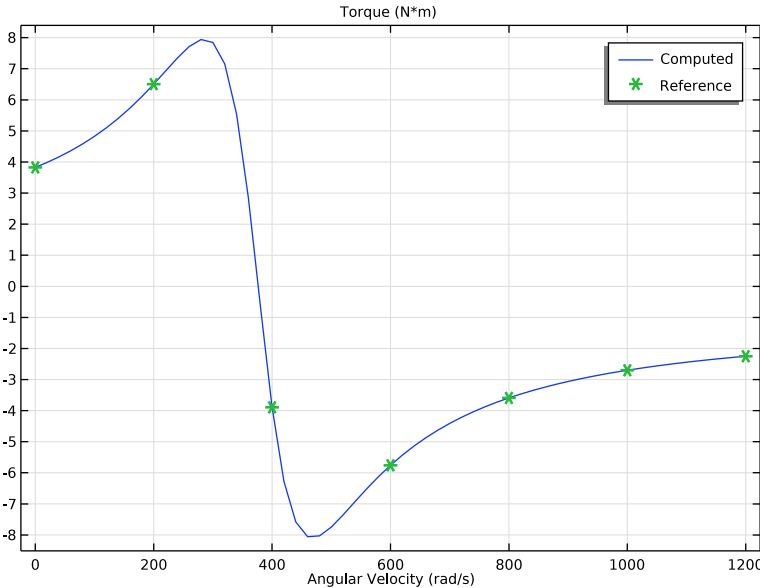

Figure 4: Computed (blue line) and analytic (green markers) torque as a function of the angular velocity of the rotor.

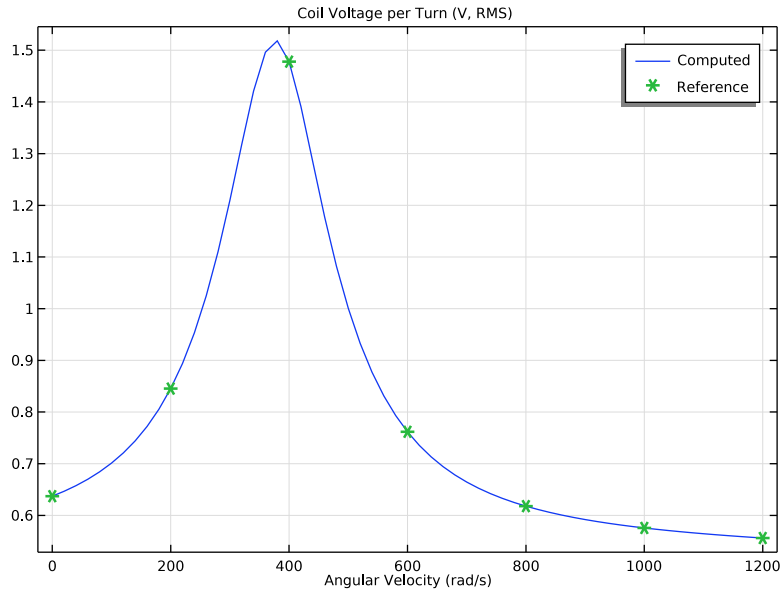

Figure 5: Computed (blue line) and analytic (green markers) coil voltage per turn as a function of the angular velocity of the rotor.

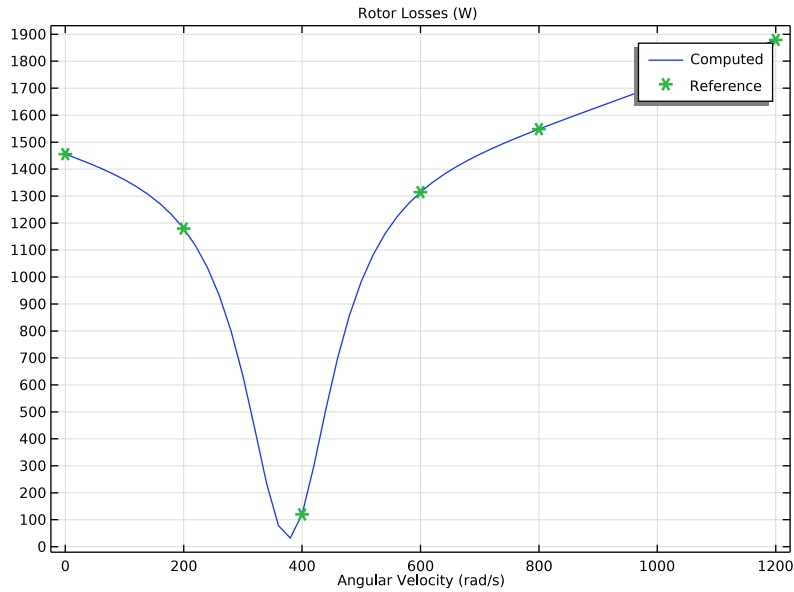

Figure 6: Computed (blue line) and analytic (green markers) rotor losses as a function of the angular velocity of the rotor.

### Reference

1. <http://www.compumag.org/jsite/team.html>

**Application Library path:** ACDC\_Module/Verification\_Examples/  
three\_phase\_motor\_frequency

### Modeling Instructions



From the **File** menu, choose **New**.

#### NEW

In the **New** window, click  **Model Wizard**.



## MODEL WIZARD

- 1 In the **Model Wizard** window, click  **2D**.
- 2 In the **Select Physics** tree, select **AC/DC>Electromagnetic Fields>Magnetic Fields (mf)**.
- 3 Click **Add**.
- 4 Click  **Study**.
- 5 In the **Select Study** tree, select **General Studies>Frequency Domain**.
- 6 Click  **Done**.

## GLOBAL DEFINITIONS



### *Parameters 1*

- 1 In the **Model Builder** window, under **Global Definitions** click **Parameters 1**.
- 2 In the **Settings** window for **Parameters**, locate the **Parameters** section.
- 3 In the table, enter the following settings:

Name	Expression	Value	Description
f0	60[Hz]	60 Hz	Supply frequency
w0	2*pi*f0	376.99 Hz	Supply angular frequency
n0	1000	1000	Number of turns
L	1[m]	1 m	Length of the motor
Omega	200[rad/s]	200 rad/s	Angular speed of the rotor
coil_wire_current	2045.175[A]*sqrt(2)/n0	2.8923 A	Current amplitude in coil wire

The geometry sequence is available in a separate file.

## GEOMETRY 1

- 1 In the **Geometry** toolbar, click  **Insert Sequence**.
- 2 Browse to the model's Application Libraries folder and double-click the file `three_phase_motor_frequency_geom_sequence.mph`.
- 3 In the **Geometry** toolbar, click  **Build All**.

4 Click the  **Zoom Extends** button in the **Graphics** toolbar.

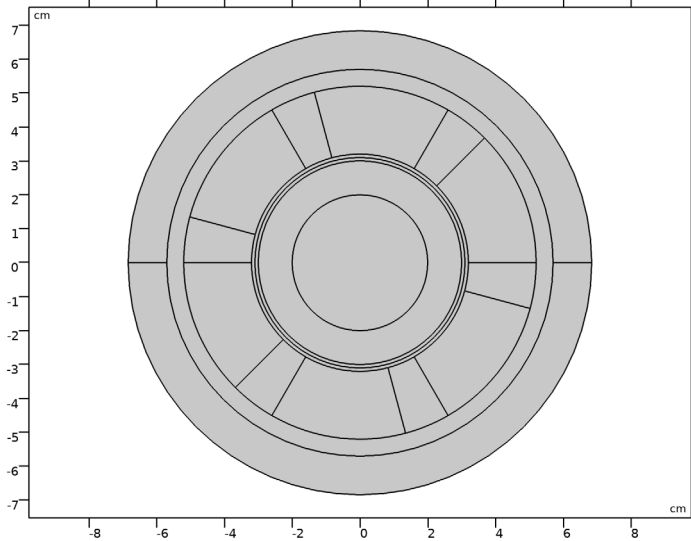

## DEFINITIONS

### *Integration, Steel*

- 1 In the **Definitions** toolbar, click  **Nonlocal Couplings** and choose **Integration**.
- 2 Select Domain 19 only.
- 3 In the **Settings** window for **Integration**, type *Integration*, *Steel* in the **Label** text field.
- 4 In the **Operator name** text field, type `int_steel`.

### *Integration, Aluminum*

- 1 In the **Definitions** toolbar, click  **Nonlocal Couplings** and choose **Integration**.
- 2 Select Domain 18 only.
- 3 In the **Settings** window for **Integration**, type *Integration*, *Aluminum* in the **Label** text field.
- 4 In the **Operator name** text field, type `int_al`.

### *Cylindrical System 2 (sys2)*

Add a cylindrical coordinate system to simplify the definition of the rotational velocity.



In the **Definitions** toolbar, click  **Coordinate Systems** and choose **Cylindrical System**.

### *Infinite Element Domain 1 (ie1)*

In the original specification, the exterior region extends to infinity. Apply an Infinite Element Domain scaling system on the outer layer for this purpose.

- 1 In the **Definitions** toolbar, click  **Infinite Element Domain**.
- 2 Select Domains 1 and 2 only.
- 3 In the **Settings** window for **Infinite Element Domain**, locate the **Geometry** section.
- 4 From the **Type** list, choose **Cylindrical**.

### **ADD MATERIAL**

- 1 In the **Home** toolbar, click  **Add Material** to open the **Add Material** window.
- 2 Go to the **Add Material** window.
- 3 In the tree, select **Built-in>Air**.
- 4 Click **Add to Component** in the window toolbar.
- 5 In the **Home** toolbar, click  **Add Material** to close the **Add Material** window.

### **MATERIALS**

#### *Aluminum*

- 1 In the **Model Builder** window, under **Component 1 (comp1)** right-click **Materials** and choose **Blank Material**.
- 2 In the **Settings** window for **Material**, type Aluminum in the **Label** text field.
- 3 Select Domain 18 only (the outer layer of the rotor).
- 4 Locate the **Material Contents** section. In the table, enter the following settings:

<b>Property</b>	<b>Variable</b>	<b>Value</b>	<b>Unit</b>	<b>Property group</b>
Relative permeability	mur_iso ; murii = mur_iso, murij = 0	1		Basic
Electrical conductivity	sigma_iso ; sigmaii = sigma_iso, sigmaij = 0	3.72e7 [S /m]	S/m	Basic
Relative permittivity	epsilon_r_iso ; epsilon_rii = epsilon_r_iso, epsilon_rij = 0	1		Basic

*Rotor Steel*

- 1 Right-click **Materials** and choose **Blank Material**.
- 2 In the **Settings** window for **Material**, type Rotor Steel in the **Label** text field.
- 3 Select Domain 19 only(the inner core of the rotor).
- 4 Locate the **Material Contents** section. In the table, enter the following settings:

Property	Variable	Value	Unit	Property group
Relative permeability	mur_iso ; murii = mur_iso, murij = 0	30		Basic
Electrical conductivity	sigma_iso ; sigmair = sigma_iso, sigmair = 0	1.6e6[S /m]	S/m	Basic
Relative permittivity	epsilon_r_iso ; epsilon_rir = epsilon_r_iso, epsilon_rir = 0	1		Basic

*Stator Steel*

- 1 Right-click **Materials** and choose **Blank Material**.
- 2 In the **Settings** window for **Material**, type Stator Steel in the **Label** text field.
- 3 Select Domain 15 only(the outer layer of the stator, before the infinite element region).
- 4 Locate the **Material Contents** section. In the table, enter the following settings:

Property	Variable	Value	Unit	Property group
Relative permeability	mur_iso ; murii = mur_iso, murij = 0	30		Basic
Electrical conductivity	sigma_iso ; sigmair = sigma_iso, sigmair = 0	0	S/m	Basic
Relative permittivity	epsilon_r_iso ; epsilon_rir = epsilon_r_iso, epsilon_rir = 0	1		Basic

## MAGNETIC FIELDS (MF)

Create three **Coil** features using the **Coil group** functionality and apply each of them on pairs of windings on opposite sides of the rotor.

### *Coil, Phase A*

- 1 In the **Model Builder** window, under **Component 1 (comp1)** right-click **Magnetic Fields (mf)** and choose the domain setting **Coil**.
- 2 Select Domains 4 and 13 only.

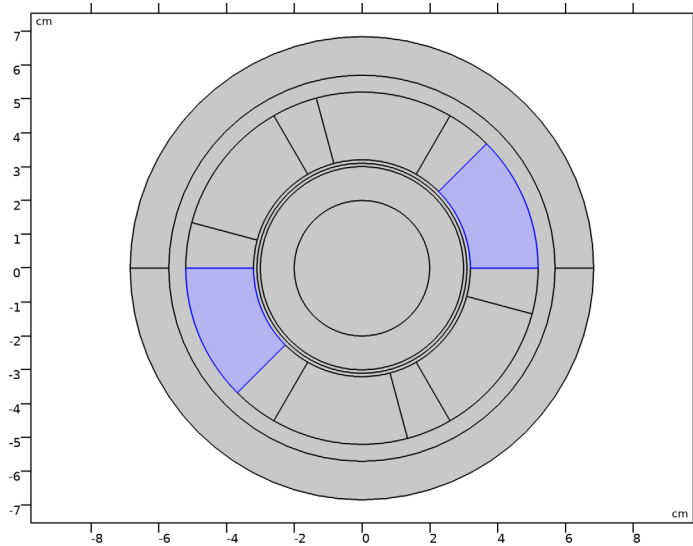

- 3 In the **Settings** window for **Coil**, type **Coil, Phase A** in the **Label** text field.
- 4 Locate the **Coil** section. From the **Conductor model** list, choose **Homogenized multiturn**.
- 5 Select the **Coil group** check box.
- 6 In the  $I_{\text{coil}}$  text field, type **coil\_wire\_current**.
- 7 Locate the **Homogenized Multiturn Conductor** section. In the  $N$  text field, type **n0**.  
The current flows in opposite directions in the two domains. Use a dedicated subfeature to specify this.

### *Reversed Current Direction I*

- 1 In the **Physics** toolbar, click  **Attributes** and choose **Reversed Current Direction**.
- 2 Select Domain 13 only.

### *Coil, Phase B*

- 1 In the **Model Builder** window, right-click **Coil, Phase A** and choose **Duplicate**.

- 2 In the **Settings** window for **Coil**, type `Coil, Phase B` in the **Label** text field.
- 3 Locate the **Domain Selection** section. Click  **Clear Selection**.
- 4 Select Domains 7 and 9 only.

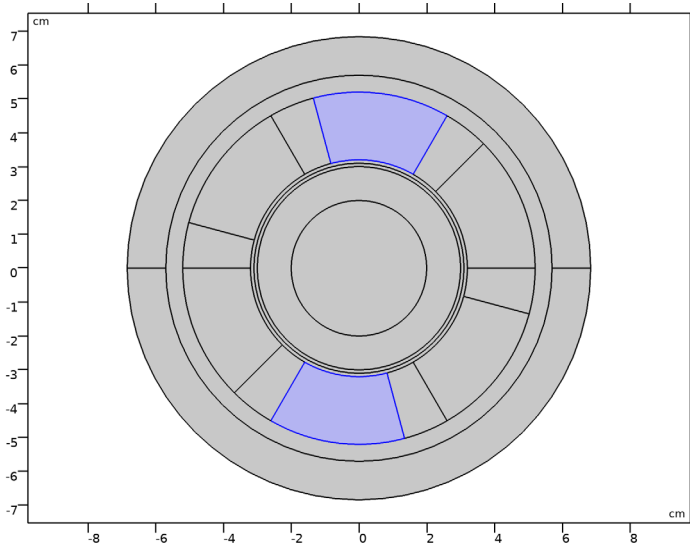

#### *Reversed Current Direction I*

- 1 In the **Model Builder** window, expand the **Coil, Phase B** node, then click **Reversed Current Direction I**.
- 2 In the **Settings** window for **Reversed Current Direction**, locate the **Domain Selection** section.
- 3 Click  **Clear Selection**.
- 4 Select Domain 7 only.

#### *Coil, Phase B*

Specify the second coil current with a  $120^\circ$  phase shift with respect to the first. In frequency domain, this corresponds to a multiplication by a complex phase factor.

- 1 In the **Model Builder** window, click **Coil, Phase B**.
- 2 In the **Settings** window for **Coil**, locate the **Coil** section.
- 3 In the  $I_{\text{coil}}$  text field, type `coil_wire_current*exp(j*2*pi/3)`.

#### *Coil, Phase C*

- 1 Right-click **Coil, Phase B** and choose **Duplicate**.

- 2 In the **Settings** window for **Coil**, type **Coil**, Phase **C** in the **Label** text field.
- 3 Locate the **Domain Selection** section. Click  **Clear Selection**.
- 4 Select Domains 5 and 11 only.

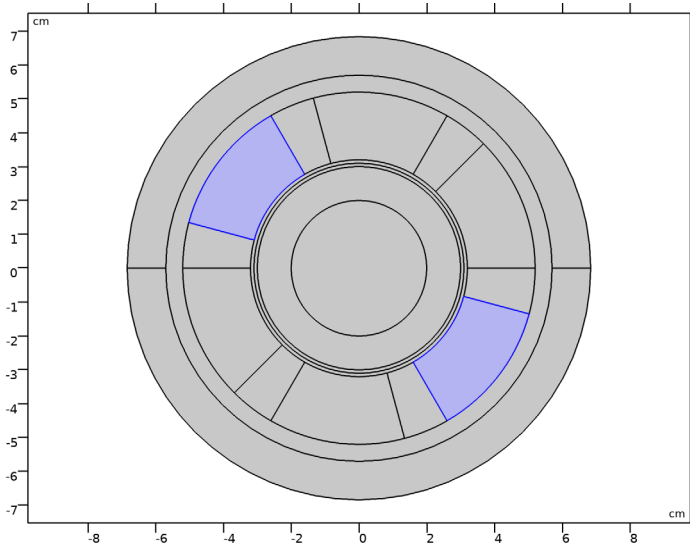

Specify the third coil current with a  $-120^\circ$  phase shift.

- 5 Locate the **Coil** section. In the  $I_{\text{coil}}$  text field, type  $\text{coil\_wire\_current} * \exp(-j * 2 * \pi / 3)$ .

#### *Reversed Current Direction I*

- 1 In the **Model Builder** window, expand the **Coil, Phase C** node, then click **Reversed Current Direction I**.
- 2 In the **Settings** window for **Reversed Current Direction**, locate the **Domain Selection** section.
- 3 Click  **Clear Selection**.
- 4 Select Domain 5 only.

#### *Velocity (Lorentz Term) I*

- 1 In the **Physics** toolbar, click  **Domains** and choose **Velocity (Lorentz Term)**.
- 2 Select Domains 18 and 19 only.
- 3 In the **Settings** window for **Velocity (Lorentz Term)**, locate the **Coordinate System Selection** section.
- 4 From the **Coordinate system** list, choose **Cylindrical System 2 (sys2)**.

5 Locate the **Velocity (Lorentz Term)** section. Specify the  $\mathbf{v}$  vector as

0	r
$\Omega \cdot \text{sys2} \cdot r$	phi

Here,  $\Omega$  is the model parameter corresponding to the angular velocity, while  $\text{sys2} \cdot r$  is the radial coordinate in the cylindrical coordinate system (with tag  $\text{sys2}$ ).

#### Force Calculation I

- 1 In the **Physics** toolbar, click  **Domains** and choose **Force Calculation**.
- 2 Select Domains 18 and 19 only.

#### MESH I

Create an appropriate mesh for the model. The mesh must be fine enough at the surface of the rotating conductor to resolve the skin depth even with the highest slip. For this particular model, this is verified already with the default mesh.

- 1 In the **Model Builder** window, under **Component 1 (comp1)** right-click **Mesh I** and choose **Build All**.  
Now, set up the study, using a parametric sweep for the rotational speed.
- 2 Right-click **Component 1 (comp1)>Mesh I** and choose **Build Selected**.

#### STUDY I

##### Parametric Sweep

- 1 In the **Study** toolbar, click  **Parametric Sweep**.
- 2 In the **Settings** window for **Parametric Sweep**, locate the **Study Settings** section.
- 3 Click **+ Add**.
- 4 In the table, enter the following settings:

Parameter name	Parameter value list	Parameter unit
Omega (Angular speed of the rotor)	range (0, 20, 1200)	Hz

##### Step 1: Frequency Domain

- 1 In the **Model Builder** window, click **Step 1: Frequency Domain**.
- 2 In the **Settings** window for **Frequency Domain**, locate the **Study Settings** section.
- 3 In the **Frequencies** text field, type  $f_0$ .
- 4 In the **Study** toolbar, click  **Compute**.



## RESULTS

### *Magnetic Flux Density Norm (mf)*

After the solution has been computed, the default surface plot will be shown. Default plot visualize the magnetic flux density lines by means of a contour plot. This setting will be added explicitly in the after the second study.

1 In the **Magnetic Flux Density Norm (mf)** toolbar, click  **Plot**.

Create an additional plot for the current density induced in the rotor.

### *Current Density*

1 In the **Home** toolbar, click  **Add Plot Group** and choose **2D Plot Group**.

Specify a custom title for the plot. Using the **Allow evaluation of expressions** functionality, it is possible to include values (such as the rotational velocity  $\Omega$ ) in the title.

2 In the **Settings** window for **2D Plot Group**, type **Current Density** in the **Label** text field.

3 Click to expand the **Title** section. From the **Title type** list, choose **Manual**.

4 Select the **Allow evaluation of expressions** check box.

5 In the **Title** text area, type  $\backslash\Omega$ : eval( $\Omega$ ) rad/s Surface: Current density ( $A/m^2$ ) Lines: Magnetic flux density.

### *Surface I*

1 Right-click **Current Density** and choose **Surface**.

2 In the **Settings** window for **Surface**, click **Replace Expression** in the upper-right corner of the **Expression** section. From the menu, choose **Component I (comp1)>Magnetic Fields>Currents and charge>Current density -  $A/m^2$ >mf.Jz - Current density, z component**.

### *Contour I*

1 In the **Model Builder** window, right-click **Current Density** and choose **Contour**.

2 In the **Settings** window for **Contour**, click **Replace Expression** in the upper-right corner of the **Expression** section. From the menu, choose **Component I (comp1)>Magnetic Fields>Magnetic>Magnetic vector potential -  $Wb/m$ >mf.Az - Magnetic vector potential, z component**.

3 Locate the **Coloring and Style** section. From the **Coloring** list, choose **Uniform**.

4 From the **Color** list, choose **Gray**.

5 Clear the **Color legend** check box.

### *Current Density*

1 In the **Model Builder** window, click **Current Density**.

- 2 In the **Settings** window for **2D Plot Group**, locate the **Data** section.
- 3 From the **Parameter value (Omega (Hz))** list, choose **200**.
- 4 In the **Current Density** toolbar, click  **Plot**.

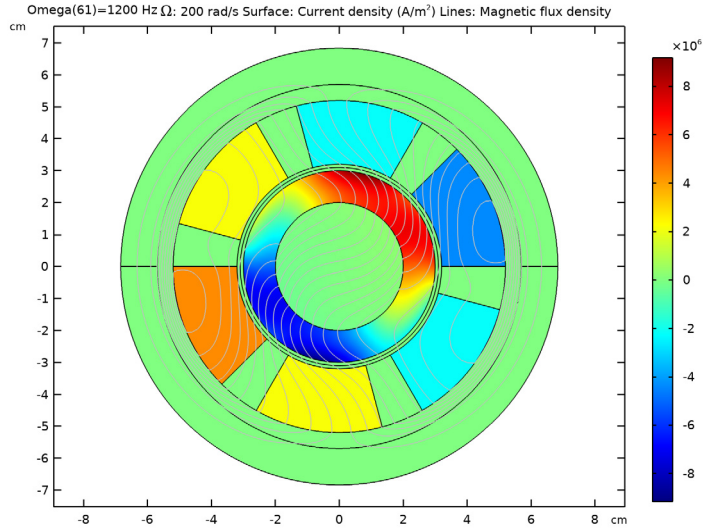

The plot shows how the field is affected by the rotor rotating more slowly than the field.

- 5 From the **Parameter value (Omega (Hz))** list, choose **380**.

6 In the **Current Density** toolbar, click  **Plot**.

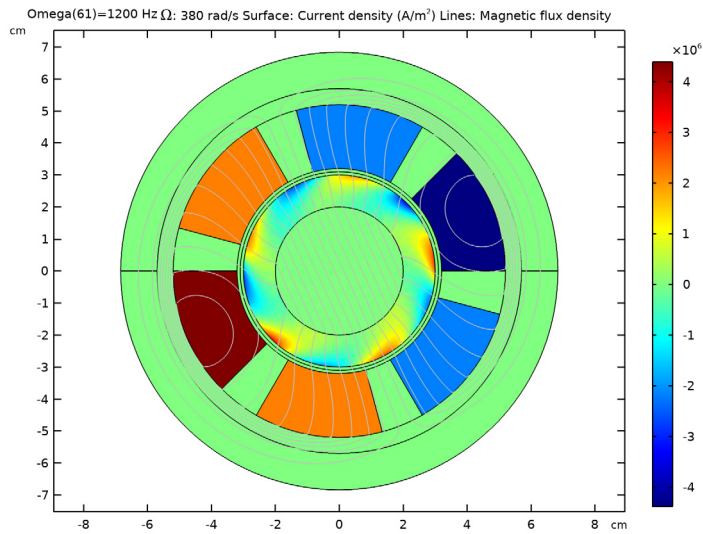

At a speed close to the synchronous speed (377 rad/s) the field lines are not deformed and the induced current densities are at a minimum.

7 From the **Parameter value (Omega (Hz))** list, choose **800**.

8 In the **Current Density** toolbar, click  **Plot**.

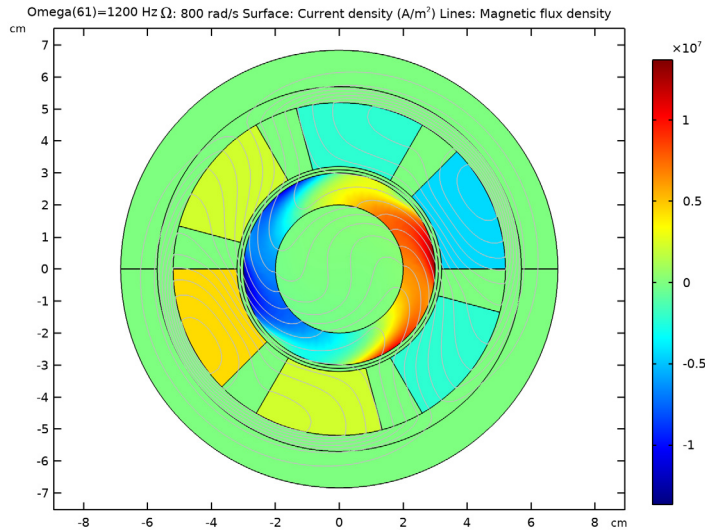

The field applies a braking effect on the fast-spinning rotor.

Import the reference analytic data and compare it to the computed solution.

#### Reference Data

- 1 In the **Results** toolbar, click  **Table**.
- 2 In the **Settings** window for **Table**, type Reference Data in the **Label** text field.
- 3 Locate the **Data** section. Click **Import**.
- 4 Browse to the model's Application Libraries folder and double-click the file `three_phase_motor_frequency_data.txt`.

#### Torque

- 1 In the **Results** toolbar, click  **ID Plot Group**.
- 2 In the **Settings** window for **ID Plot Group**, type Torque in the **Label** text field.
- 3 Click to expand the **Title** section. From the **Title type** list, choose **Manual**.
- 4 In the **Title** text area, type Torque (N\*m).
- 5 Locate the **Plot Settings** section. Select the **x-axis label** check box.
- 6 In the associated text field, type Angular Velocity (rad/s).

#### Global I

- 1 Right-click **Torque** and choose **Global**.

- 2 In the **Settings** window for **Global**, click **Replace Expression** in the upper-right corner of the **y-Axis Data** section. From the menu, choose **Component 1 (comp1)>Magnetic Fields>Mechanical>Torque - N·m>mf.Tz\_0 - Torque, z component**.
- 3 Click to expand the **Legends** section. From the **Legends** list, choose **Manual**.
- 4 In the table, type **Computed** in the first row.

*Table Graph 1*

- 1 In the **Model Builder** window, right-click **Torque** and choose **Table Graph**.
- 2 In the **Settings** window for **Table Graph**, locate the **Data** section.
- 3 From the **Plot columns** list, choose **Manual**.
- 4 In the **Columns** list, select **Torque (N\*m)**.
- 5 Locate the **Coloring and Style** section. Find the **Line style** subsection. From the **Line** list, choose **None**.
- 6 Find the **Line markers** subsection. From the **Marker** list, choose **Cycle**.
- 7 From the **Positioning** list, choose **In data points**.
- 8 Click to expand the **Legends** section. Select the **Show legends** check box.
- 9 From the **Legends** list, choose **Manual**.
- 10 In the table, type **Reference** in the first row.

II In the **Torque** toolbar, click  **Plot**.

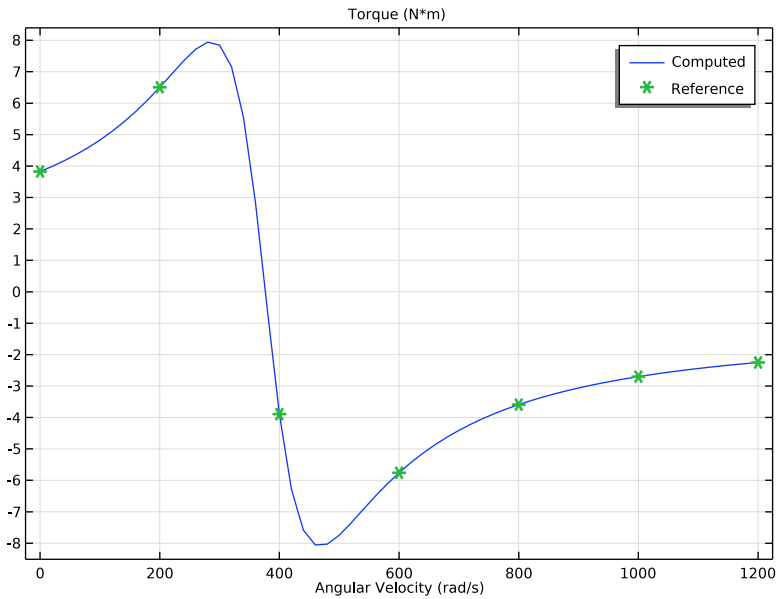

### Coil Voltage

- 1 Right-click **Torque** and choose **Duplicate**.
- 2 In the **Settings** window for **ID Plot Group**, type **Coil Voltage** in the **Label** text field.
- 3 Locate the **Title** section. In the **Title** text area, type **Coil Voltage per Turn (V, RMS)**.

### Global I

- 1 In the **Model Builder** window, expand the **Coil Voltage** node, then click **Global I**.
- 2 In the **Settings** window for **Global**, locate the **y-Axis Data** section.
- 3 In the table, enter the following settings:

Expression	Unit	Description
$\text{abs}(\text{mf.coil1.Vind}) / (\text{n0} * \text{sqrt}(2))$	V	

### Table Graph I

- 1 In the **Model Builder** window, click **Table Graph I**.
- 2 In the **Settings** window for **Table Graph**, locate the **Data** section.
- 3 In the **Columns** list, select **Vin/turn (V)**.

4 In the **Coil Voltage** toolbar, click  **Plot**.

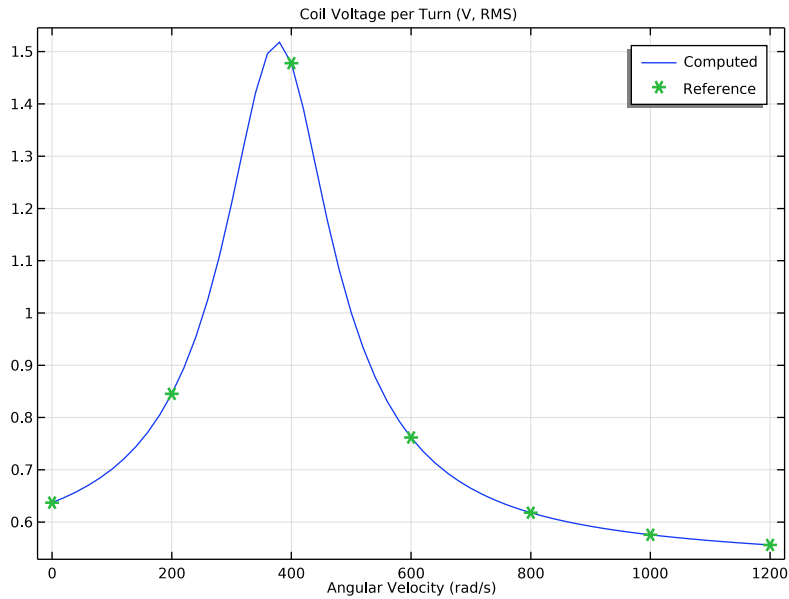

#### Rotor Losses

- 1 In the **Model Builder** window, right-click **Coil Voltage** and choose **Duplicate**.
- 2 In the **Settings** window for **ID Plot Group**, type Rotor Losses in the **Label** text field.
- 3 Locate the **Title** section. In the **Title** text area, type Rotor Losses (W).

#### Global I

- 1 In the **Model Builder** window, expand the **Rotor Losses** node, then click **Global I**.
- 2 In the **Settings** window for **Global**, locate the **y-Axis Data** section.
- 3 In the table, enter the following settings:

Expression	Unit	Description
$\text{int\_steel}(\text{mf.Qh} * \text{L}) + \text{int\_al}(\text{mf.Qh} * \text{L})$	W	

#### Table Graph I

- 1 In the **Model Builder** window, click **Table Graph I**.
- 2 In the **Settings** window for **Table Graph**, locate the **Data** section.
- 3 In the **Columns** list, select **Rotor Loss (W)**.

4 In the **Rotor Losses** toolbar, click  **Plot**.

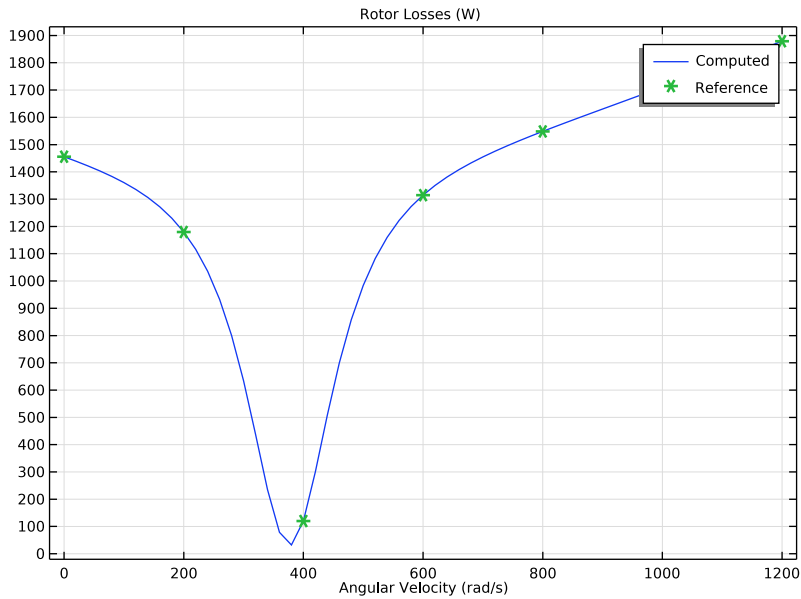

#### Steel Losses

1 In the **Model Builder** window, right-click **Rotor Losses** and choose **Duplicate**.

2 In the **Settings** window for **ID Plot Group**, type Steel Losses in the **Label** text field.

3 Locate the **Title** section. In the **Title** text area, type Steel Losses (W).

#### Global I

1 In the **Model Builder** window, expand the **Steel Losses** node, then click **Global I**.

2 In the **Settings** window for **Global**, locate the **y-Axis Data** section.

3 In the table, enter the following settings:

Expression	Unit	Description
int_steel(mf.Qh*L)	W	Integration, Steel

#### Table Graph I

1 In the **Model Builder** window, click **Table Graph I**.

2 In the **Settings** window for **Table Graph**, locate the **Data** section.

3 In the **Columns** list, select **Steel\_Loss (W)**.



4 In the **Steel Losses** toolbar, click  **Plot**.

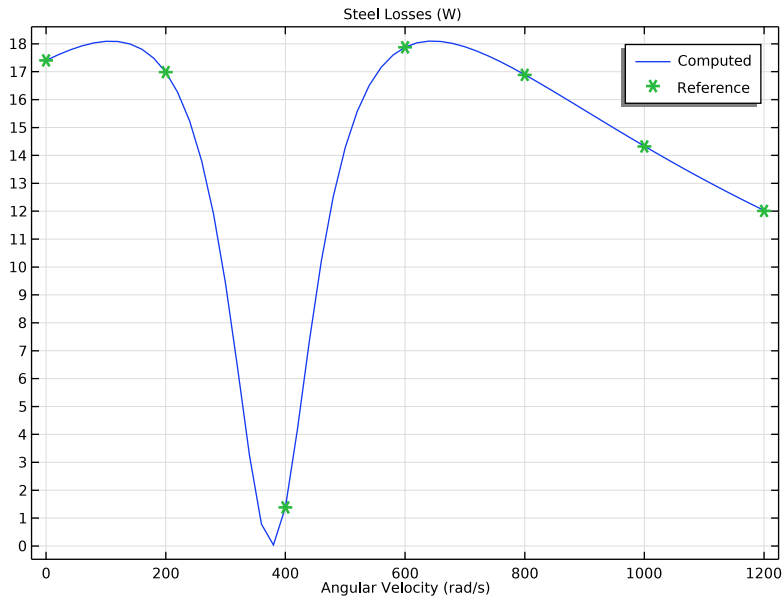

### *Current Density*

Click the  **Zoom Extents** button in the **Graphics** toolbar.

Finally, to appreciate the dynamics of the rotating field, create an animation of the time-harmonic solution.

### *Animation 1*

- 1 In the **Results** toolbar, click  **Animation** and choose **Player**.
- 2 In the **Settings** window for **Animation**, locate the **Animation Editing** section.
- 3 From the **Sequence type** list, choose **Dynamic data extension**.
- 4 Locate the **Playing** section. From the **Repeat** list, choose **Forever**.
- 5 In the **Graphics** toolbar, use the **Play** and **Stop** buttons to control the animation.

