



Submarine Cable 2 — Capacitive Effects

Introduction

This tutorial discusses a 2D finite element model of a standard three-core, lead sheathed XLPE HVAC¹ submarine cable, with a main conductor cross section of 500 mm^2 , and a phase-to-phase operating voltage of 220 kV. Capacitive effects are analyzed. The tutorial validates the assumption that for the capacitance and the charging currents, analytical approaches are sufficiently accurate (verification is included).

The influence of material properties, the cable's length and bonding types is discussed. The model justifies the approach chosen in subsequent tutorials in this series, most notably, the *Bonding Capacitive* and the *Inductive Effects* tutorials (chapters 3, and 4).

Model Definition

The geometry of the cable is shown in [Figure 1](#). It describes a detailed cross section (as built in the *Introduction* tutorial). A large number of material properties is included for the metals, the polymers, and the sea bed.

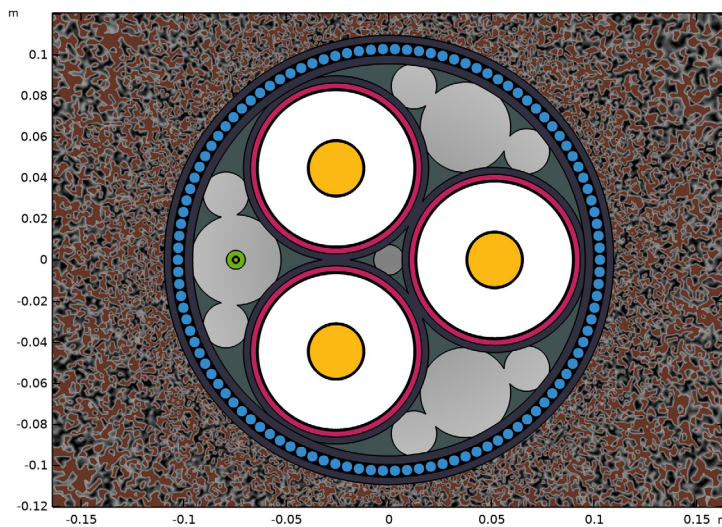

Figure 1: The cable's cross section, including the three phases (yellow), screens (red), the XLPE (white), the armor (blue), and the fiber (green).

1. Cross-linked polyethylene, high-voltage alternating current.

THEORETICAL BASIS

The model solves a 2D in-plane current conservation problem in the frequency domain. This includes the following:

$$\begin{aligned}\mathbf{E} &= -\nabla V \\ \nabla \cdot \mathbf{D} &= \rho \\ \nabla \cdot \mathbf{J} &= -j\omega\rho,\end{aligned}\tag{1}$$

for the electric field, Gauss's law, and current conservation. The *differential form* is used here, together with the *SI unit system*: \mathbf{E} , \mathbf{D} , and \mathbf{J} are in V/m, C/m², and A/m², respectively. Note that defining the electric field solely by means of the electric potential gradient — thus excluding the terms based on the magnetic vector potential \mathbf{A} — is valid only when the electric field is *curl-free*, that is; when Faraday's law evaluates to zero:

$$\nabla \times \mathbf{E} = -j\omega\mathbf{B} = 0.\tag{2}$$

If the electric field would not be curl-free, there would be no such thing as a unique electric potential V (even with the proper boundary constraints in place). In those cases you can walk along a closed loop, integrating the electric field as you go (to determine the local potential), and end up in the same spot with an electric potential that differs from the one you started with. The chosen electric field definition $\mathbf{E} = -\nabla V$ basically implies that in-plane electric fields caused by electromagnetic induction are assumed to be negligible.

Admittedly, the 3D twist models in the *Inductive Effects 3D* tutorial will show you that magnetically induced in-plane electric fields *do* form, and that they are not curl-free (they drive small eddies in the conductors). Those electric fields are on the order of several Volts per meter however; they are completely overshadowed by the curl-free electric fields from the phase-to-ground voltage of 127 kV. And even if they would have had the same order of magnitude, their direction is such that they do not contribute to the phase-to-ground capacitive phenomenon. This justifies the set of relations shown in [Equation 1](#).

Apart from the potential definitions and conservation laws, we have the following *constitutive relations* (the ones containing material properties):

$$\begin{aligned}\mathbf{D} &= \varepsilon_0\varepsilon_r\mathbf{E} = \varepsilon\mathbf{E} \\ \mathbf{J} &= \sigma\mathbf{E}.\end{aligned}\tag{3}$$

Some people may prefer to include the *displacement current* in the definition of the current. This gives you $\nabla \cdot \mathbf{J} = 0$ and $\mathbf{J} = \sigma\mathbf{E} + j\omega\mathbf{D}$ for the current conservation law and the current definition, respectively.

Regardless the convention you choose, when you piece everything together, you end up with the following *2D partial differential equation* for the dependent variable V :

$$-\nabla \cdot ((\sigma + j\omega\epsilon)\nabla V) = 0. \quad (4)$$

The Electric Currents interface uses this conservation law to determine the value of V in the domains. For the boundaries, several *Dirichlet conditions* are used. For the three phases with phase-to-ground voltage V_0 we have:

$$V_a = V_0 \quad V_b = V_0 e^{-j\frac{2\pi}{3}} \quad V_c = V_0 e^{+j\frac{2\pi}{3}}, \quad (5)$$

where a complex exponent $e^{j\phi}$ is used to set a 120° phase shift between the phases. Combined with $V_g = 0$ for ground (the infinity condition used at the outer boundary), this gives you a complete set of equations.

MODELING APPROACH

The tutorial starts with the basics, by applying a potential to the phases and the sea bed, using the **Terminal** and the **Ground** feature. As a result the screens are left floating, and properties like capacitance are rather nontrivial.

In practice, however, the screens are typically grounded. For determining the cable's capacitive properties per phase in $\mu\text{F}/\text{km}$, oftentimes the analytical relation for coaxial capacitors is used:

$$C = \frac{2\pi\epsilon_0\epsilon_r}{\ln(R_2/R_1)}, \quad (6)$$

where $\epsilon_0\epsilon_r$ refers to the insulator's permittivity, and R_1, R_2 , refer to the insulator's outer, and inner radius, respectively. From the capacitance C and the applied voltage V_0 , the charging current per phase in A/km can be derived as follows:

$$I_c = j\omega CV_0. \quad (7)$$

[Equation 6](#) implicitly assumes a perfect insulator, sandwiched between two perfect conductors. What is more, it assumes that each phase together with its screen can be considered an isolated problem: Capacitive effects between the screens and ground are completely neglected.

In other words, the phases are considered to be at $V_0 e^{j\phi}$, the screens are considered to be grounded, and the currents outside the screens are assumed to be zero. Near the ground and feeding point these assumptions seem valid. After 10 km of cable however, with

single-point bonding² applied, conditions are less clear. Results from the *Inductive Effects* and the *Bonding Capacitive* tutorials are used to make an educated guess on how much the phase and screen potentials will deviate from their value near the ground point.

ON ILL-POSED PROBLEMS

The model includes a very large contrast in conductivity, about $\sigma_{\text{cu}}/\omega\epsilon_0 \approx 2.1 \cdot 10^{16}$, where σ_{cu} refers to the copper conductivity and $\omega\epsilon_0$ can be considered the displacement current conductivity in air (the logic behind this follows from [Equation 4](#)). This large contrast leads to what is known as an *ill-posed problem*.

The cable's cross section is basically a complex system of resistors and capacitors. The current, when crossing from the phase to the ground, will encounter a very large impedance (the XLPE). Then, it will encounter a very small impedance (the screen) and continue in the polyethylene (assuming the lead is a floating potential).

Since the impedance of the XLPE is on the order of 10^{15} times larger than the impedance in the lead, the voltage drop in the lead will be about 10^{15} times smaller. This voltage drop is numerically completely insignificant. Resolving this large contrast would require an extreme precision (and consequently, a lot of computational resources). Even so, this voltage drop is needed in order to determine the amount of current flowing through the metal.

One solution is to just reduce the contrast to a level that can be resolved more easily; about 10^6 , to 10^{10} . When you are interested in the currents (and potential gradient) in the insulators, a material with a conductivity 10^8 times higher is more than sufficient for modeling metallic behavior. This is also why the semi-conductive compound behaves like a metal — and so does the sea bed — even though it has a conductivity less than sea water.

Reducing the contrast will not significantly influence accuracy, as the XLPE's impedance will still completely dominate the results: Just picture a 1Ω and a $1 \mu\Omega$ resistor in series, compared to a 1Ω and a $1 \text{ p}\Omega$ resistor; the current will be similar.

Another solution is to exclude the metal domain from the model altogether and put an equipotential boundary condition on its outer boundaries instead. In that case, the potential distribution inside the metal is not part of the finite element model any longer; it is assumed to be perfectly constant. This is the approach used by the **Terminal** features. In terms of resistors placed in series, it means the $1 \text{ p}\Omega$ resistor is removed from the circuit altogether.

2. For more information on the different bonding types, see the *Bonding Capacitive* and *Bonding Inductive* tutorials in this series.

Please be aware though, when you place insulators and metals in parallel, it will be the metals that are dominant (this case is demonstrated in the *Bonding Capacitive* tutorial). When this is the case, oftentimes it is the insulators that are excluded, or given less contrasting material properties. People tend to be much more comfortable with excluding insulators from an electric currents model. Obviously, this is not always appropriate.

Results and Discussion

For 10 km of cable with single-point bonding applied and all voltage inducing effects in-phase — the worst-case scenario³ — it turns out the analytical approximation for the cable’s capacitance (Equation 6), still holds: 0.14 $\mu\text{F}/\text{km}$.

The drop in phase potential along the cable due to the AC resistance is estimated to be 490 V. The raise in screen potential is expected to be 83 V + 473 V at most, from capacitive and inductive effects, respectively (as found in the *Bonding Capacitive* and *Bonding Inductive* tutorials). Thanks to the large phase-to-ground feeding potential of 127 kV (as given by $220/\sqrt{3}$), all these secondary voltages are shown to be negligible⁴.

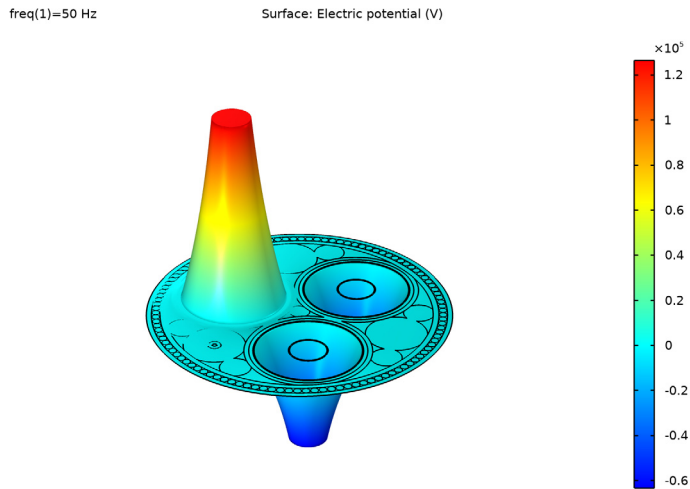

Figure 2: The real part of the cross-sectional potential distribution at phase $\varphi = 0$.

3. While still considering nominal conditions, that is; no short-circuit or electromagnetic breakdown.

4. That is, under normal operating conditions, power surges are a different matter.

With the screen potential relatively close to zero, the capacitive coupling between the screens is insignificant. This justifies the “isolated phase” approach chosen in the *Bonding Capacitive* tutorial. Furthermore, the in-plane current densities due to capacitive effects are proven negligible compared to the applied and induced out-of-plane current densities; about $2.95 \cdot 10^7$ times smaller.

This partly justifies the approach chosen in the *Inductive Effects* tutorial, where in-plane currents are neglected. Additionally, it tells us 3D cable models will usually end up focusing on the inductive (or thermal) part of the device, as resolving the small in-plane displacement current densities together with the much stronger out-of-plane conduction current densities would require an impractical numerical precision.

In the cross section of the cable, the large contrast in material properties (as given by $\sigma_{pb}/\omega\epsilon_{xlpe} \approx 6.5 \cdot 10^{14}$) makes it possible to consider the cross-linked polyethylene (XLPE) a perfect insulator, and the lead (Pb) a perfect conductor — the copper even more so. Even the semi-conductive compound with a conductivity of about 2 S/m can be considered a perfect conductor. This, too, corresponds to the analytical approximation, as shown in [Equation 6](#).

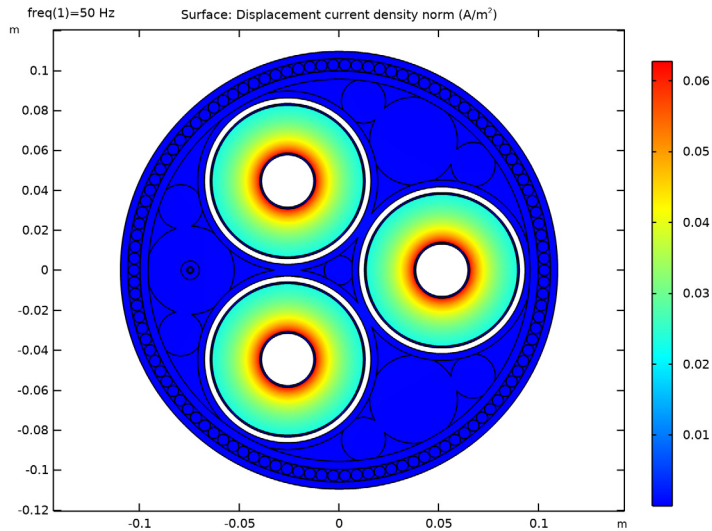

Figure 3: The displacement current density norm in the XLPE insulation.

For all intents and purposes, the COMSOL Multiphysics model shows *perfect correspondence* to the analytically determined figures. In the end, when it comes to the cable's capacitance, all details in the model turn out to be superfluous. Except for three:

- The cross-linked polyethylene's permittivity.
- The outer radius of the cross-linked polyethylene.
- The inner radius of the cross-linked polyethylene.

This is crucial knowledge. Numerical models like this are capable of showing the essence of a device before prototyping starts. It allows engineers that are new to a certain field to figure out what is important.

ON ACCURACY

You might be tempted to make the model correspond to theoretical results or specifications up to the tenth digit — spending a lot of time on geometric details, mesh quality, and so on. And you might think a more “accurate” model is somehow better.

Please keep in mind though, by far the most important figure here is ϵ_{xlpe} (a measured quantity given in two digits). If that figure is off by 5%, the rest of the model will be off, too, regardless of how many details you put in it or how well it corresponds to the analytical solution. *After all, any model is only as accurate as the data you put into it.*

That being said, the behavior itself is very accurate. If you want to make a qualitative assessment for a device (to understand its nature), even material properties that are 50% off will do fine.

References

1. International Electrotechnical Commission, *Electric cables – Calculation of the Current Rating*; IEC 60287; IEC Press: Geneva, Switzerland, 2006.
2. Video file submarine_cable_z_animation_01_floating_screen, available for download at <https://www.comsol.com/model/43431>.
3. Video file submarine_cable_z_animation_02_fixed_screen, available for download at <https://www.comsol.com/model/43431>.

Application Library path: ACDC_Module/Tutorials,_Cables/
submarine_cable_02_capacitive_effects

Modeling Instructions

This tutorial will focus on capacitive effects. The instructions on the following pages will help you to build, configure, solve and analyze the model. If anything seems out of order, please retrace your steps. The finalized model — available in the model’s Application Libraries folder — can help you out. You can compare it directly to your current model by means of the **Compare** option on the **Developer** toolbar.

ROOT

The geometry, materials, and mesh have been prepared in the *Introduction* tutorial (chapter 1). They have been saved in the file `submarine_cable_01_introduction.mph`. You can start by opening this file and saving it under a new name.



Hint; if you are new to COMSOL Multiphysics, it is worthwhile to check out the Introduction tutorial first.

- 1 From the **File** menu, choose **Open**.
- 2 Browse to the model’s Application Libraries folder and double-click the file `submarine_cable_01_introduction.mph`.
- 3 From the **File** menu, choose **Save As**.
- 4 Browse to a suitable folder and type the filename `submarine_cable_02_capacitive_effects.mph`.

GLOBAL DEFINITIONS

Some parameters have been prepared for running the model, and verifying results afterward. You can load them from a file.

Electromagnetic Parameters

- 1 In the **Home** toolbar, click  **Parameters** and choose **Add>Parameters**.
- 2 In the **Settings** window for **Parameters**, type *Electromagnetic Parameters* in the **Label** text field.
- 3 Locate the **Parameters** section. Click  **Load from File**.
- 4 Browse to the model’s Application Libraries folder and double-click the file `submarine_cable_c_elec_parameters.txt`.

Eighteen new parameters have been added. f_0 , w_0 , V_0 and I_0 are pretty straightforward, where $1/\sqrt{3}$ and $\sqrt{2}$ convert from phase-to-phase to phase-to-ground, and from root mean square (RMS) to peak value respectively. Scup to Ds_{arm} are some material



properties and the skin depths derived from those (as used in the *Inductive Effects* tutorials), and R_{con} , R_{pbs} are analytically determined DC resistances.

The parameter C_{pha} is the cable's analytically determined capacitance per phase, as given by Equation 6. Here, ϵ_{xlpe} refers to the relative permittivity of XLPE; 2.5 (the value is taken from IEC 60287 [1]). In the expression for C_{pha} , the metals and the semi-conductive compound are considered *perfect conductors*, so the outer and inner radius of the XLPE layer is used.

Lastly, the charging current per phase, I_{cpha} , follows from Equation 7. It evaluates to about 5.5 A/km. Note that this approach implicitly assumes a constant potential everywhere along the cable, with the screen being grounded.

Let us investigate the situation without these assumptions, check the details numerically, and see if it leads to the same conclusions as the analytical description. Start by adding the physics and a new study.

ADD PHYSICS



- 1 In the **Home** toolbar, click  **Add Physics** to open the **Add Physics** window.
- 2 Go to the **Add Physics** window.
- 3 In the tree, select **AC/DC>Electric Fields and Currents>Electric Currents (ec)**.
- 4 Click **Add to Component I** in the window toolbar.
- 5 In the **Home** toolbar, click  **Add Physics** to close the **Add Physics** window.

ELECTRIC CURRENTS (EC)

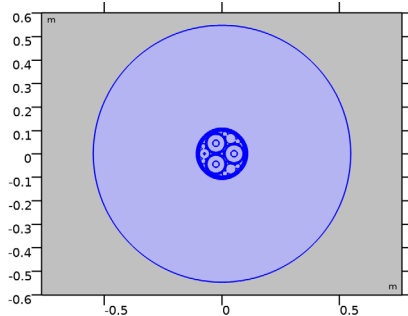
- 1 In the **Settings** window for **Electric Currents**, locate the **Domain Selection** section.
- 2 From the **Selection** list, choose **Electromagnetic Domains**.
- 3 Click the  **Zoom to Selection** button in the **Graphics** toolbar.



ADD STUDY

- 1 In the **Home** toolbar, click  **Add Study** to open the **Add Study** window.
- 2 Go to the **Add Study** window.
- 3 Find the **Studies** subsection. In the **Select Study** tree, select **General Studies> Frequency Domain**.
- 4 Click  **Add Study**.
- 5 In the **Home** toolbar, click  **Add Study** to close the **Add Study** window.

STUDY I

Step 1: Frequency Domain

- 1 In the **Settings** window for **Frequency Domain**, locate the **Study Settings** section.
- 2 In the **Frequencies** text field, type f_0 .

MATERIALS

Now, you will see that COMSOL starts detecting missing material properties. The properties that should be added are listed in the following table. Please check all of them for the correct value, even the ones that are already filled in. *A quick option is to copy-paste the values directly from this *.pdf file to COMSOL.*

- 1 In the **Model Builder** window, under **Component 1 (comp1)>Materials**, check the following properties:

	Label	sigma [S/m]	epsilon
mat6	Cross-linked polyethylene (XLPE)	1e-18[S/m]	Ex1pe
mat11	Copper	Scup	1
mat12	Lead	Spbs	1
mat13	Galvanized steel	Sarm	1

Please be aware that in the end, many material properties will be either ignored, overridden, or proven to be insignificant. Figuring out which ones are important oftentimes is an essential part of research. For more on this, see section [Results and Discussion](#).

Modeling Instructions — Floating Screen

Now that the materials have been set and double-checked, please have a look at the physics. As a starting point, assume that the sea bed is grounded and that the 2D cross

section that this model represents is located close to the point of excitation, that is, that the phase voltage norm is equal to V_0 .



ELECTRIC CURRENTS (EC)

Ground 1

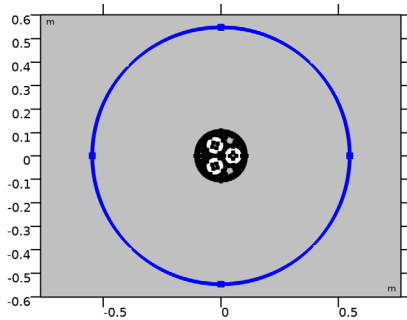
- 1 In the **Model Builder** window, under **Component 1 (comp1)** right-click **Electric Currents (ec)** and choose **Ground**.
- 2 Select Boundaries 12, 13, 338, and 348 only.
- 3 Click the  **Zoom to Selection** button in the **Graphics** toolbar.



Current Conservation 2

- 1 In the **Physics** toolbar, click  **Domains** and choose **Current Conservation**.
- 2 In the **Settings** window for **Current Conservation**, locate the **Domain Selection** section.
- 3 From the **Selection** list, choose **Metals**.
- 4 Click the  **Zoom to Selection** button in the **Graphics** toolbar.

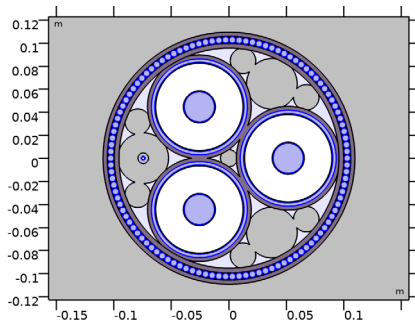

This last feature (**Current Conservation 2**) needs some explaining. At this point, it just overrides the default current conservation feature using the same settings. We will get back to this later.

Phase 1

- 1 In the **Physics** toolbar, click  **Domains** and choose **Terminal**.
- 2 In the **Settings** window for **Terminal**, type Phase 1 in the **Label** text field.
- 3 Locate the **Domain Selection** section. From the **Selection** list, choose **Phase 1**.

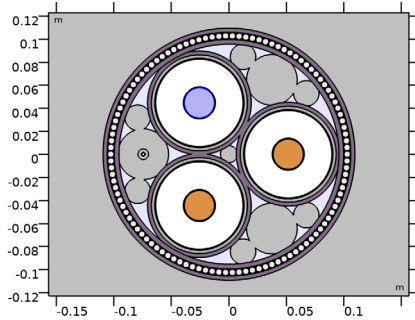

- 4 Locate the **Terminal** section. From the **Terminal type** list, choose **Voltage**.
- 5 In the V_0 text field, type V_0 .

Phase 2

- 1 In the **Physics** toolbar, click  **Domains** and choose **Terminal**.
- 2 In the **Settings** window for **Terminal**, type Phase 2 in the **Label** text field.
- 3 Locate the **Domain Selection** section. From the **Selection** list, choose **Phase 2**.

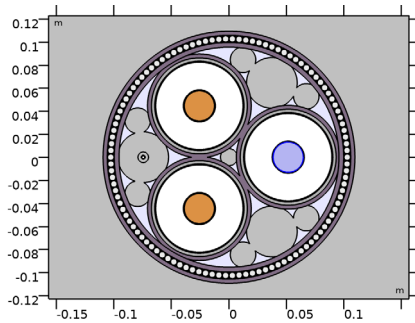

- 4 Locate the **Terminal** section. From the **Terminal type** list, choose **Voltage**.
- 5 In the V_0 text field, type $V_0 \cdot \exp(-120[\text{deg}] \cdot j)$.

Phase 3

- 1 In the **Physics** toolbar, click  **Domains** and choose **Terminal**.
- 2 In the **Settings** window for **Terminal**, type Phase 3 in the **Label** text field.

3 Locate the **Domain Selection** section. From the **Selection** list, choose **Phase 3**.

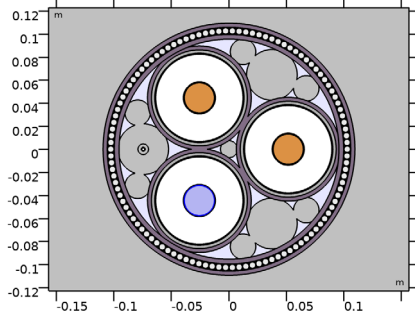

4 Locate the **Terminal** section. From the **Terminal type** list, choose **Voltage**.

5 In the V_0 text field, type $V_0 \cdot \exp(+120[\text{deg}] \cdot j)$.

Note that, since we are in the frequency domain, expressions like $\exp(-120[\text{deg}] \cdot j)$ or $\exp(-j \cdot 2 \cdot \pi / 3)$ may be used to set a 120° phase shift between the AC voltages on the three main conductors.

So now you have added a current conservation law with some material properties, a ground reference and a form of excitation. Together with the frequency domain study — *with the frequency set* — you should be free to go.

STUDY 1

1 In the **Home** toolbar, click **Compute**.

An error should appear: “Failed to find a solution”.

2 Click **OK**.

So what happened here? In numerical mathematics, this model is known as an *ill-posed problem*. When modeling (regardless of the software used) you will encounter this problem every once in a while. As explained in section [On Ill-Posed Problems](#), one of the solutions is to reduce the contrast in conductivity. You can set the conductivity of the metals to the seemingly small value of 5 [S/m] (the conductivity of sea water). This brings us back to **Current Conservation 2**.

Current Conservation 2

1 In the **Model Builder** window, click **Current Conservation 2**.

2 In the **Settings** window for **Current Conservation**, locate the **Constitutive Relation Jc-E** section.

3 From the σ list, choose **User defined**. In the associated text field, type 5 [S/m] .

For all the metals (excluding the phases) you have now overridden the default conductivity with a user-defined setting. Proceed by computing the solution.

STUDY 1

In the **Home** toolbar, click  **Compute**.



RESULTS

Electric Potential (ec)

The first thing to notice is that the **Electric Potential** plot is zoomed in quite a bit. This is because it is still locked to the camera settings used in the geometry and the mesh. Let us give it separate view settings.

- 1 In the **Settings** window for **2D Plot Group**, locate the **Plot Settings** section.
- 2 From the **View** list, choose **New view**.

Surface 1

- 1 In the **Model Builder** window, expand the **Electric Potential (ec)** node, then click **Surface 1**.
- 2 In the **Settings** window for **Surface**, click to expand the **Quality** section.
- 3 From the **Resolution** list, choose **Fine**.
- 4 In the **Electric Potential (ec)** toolbar, click  **Plot**.
- 5 Click the  **Zoom Extents** button in the **Graphics** toolbar.

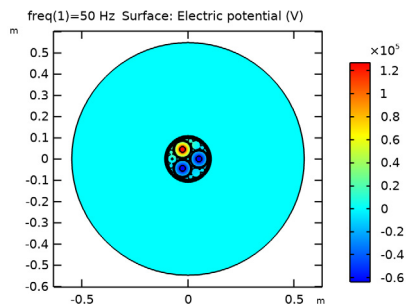



The second thing to notice is that compared to the polymers the sea bed is conducting so well that it is behaving like an *equipotential* (like a metal). The currents are too small for a significant potential drop to be seen there.

You can exclude the sea bed from the plot by adding a selection to the solution.

Study 1/Solution 1 (sol1)

In the **Model Builder** window, expand the **Results>Datasets** node, then click **Study 1/Solution 1 (sol1)**.

Selection

- 1 In the **Results** toolbar, click  **Attributes** and choose **Selection**.
- 2 In the **Settings** window for **Selection**, locate the **Geometric Entity Selection** section.
- 3 From the **Geometric entity level** list, choose **Domain**.
- 4 From the **Selection** list, choose **Cable Domains**.
- 5 Click the  **Zoom to Selection** button in the **Graphics** toolbar.

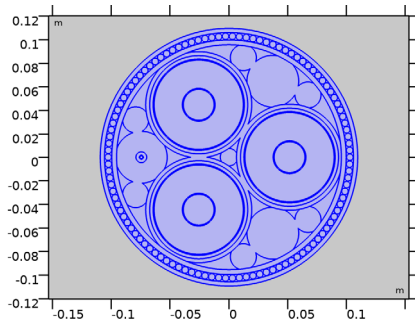

Electric Potential (ec)

- 1 In the **Model Builder** window, click **Electric Potential (ec)**.
- 2 In the **Electric Potential (ec)** toolbar, click  **Plot**.

3 Click the  **Zoom Extents** button in the **Graphics** toolbar.

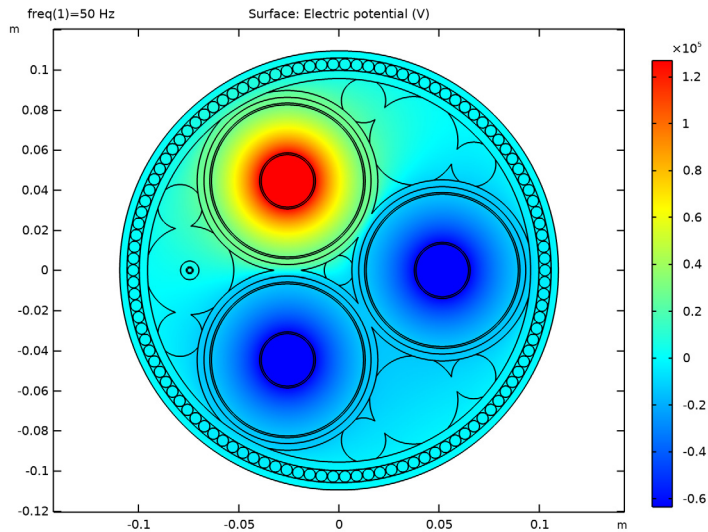



Next, let us have a look at the electric field norm and some current plots.

Electric Field Norm (ec)

- 1 Right-click **Electric Potential (ec)** and choose **Duplicate**.
- 2 In the **Settings** window for **2D Plot Group**, type **Electric Field Norm (ec)** in the **Label** text field.

Surface 1

- 1 In the **Model Builder** window, expand the **Electric Field Norm (ec)** node, then click **Surface 1**.
- 2 In the **Settings** window for **Surface**, locate the **Expression** section.
- 3 In the **Expression** text field, type `ec.normE`.
- 4 In the **Electric Field Norm (ec)** toolbar, click  **Plot**.

5 Click the  **Zoom Extents** button in the **Graphics** toolbar.

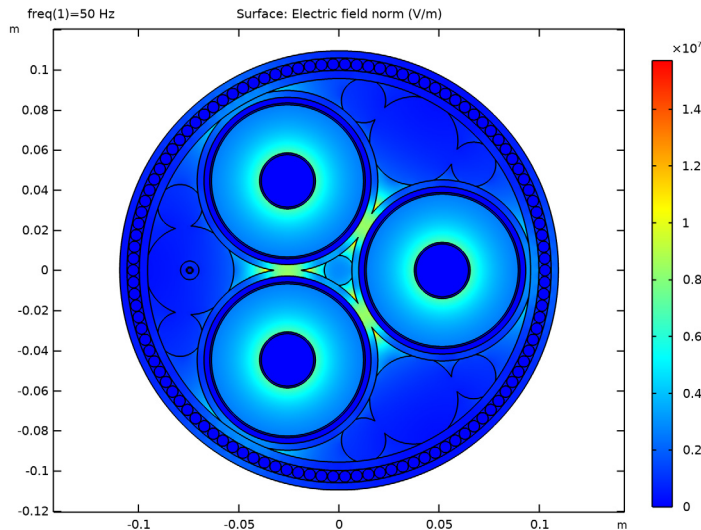

The electric field is most prominent in the insulators, in the metals it is negligible (as it should). Significant electric fields exist outside the screens, suggesting the screens are not doing a very good job (we will get back to that later). Furthermore, the field is much stronger than the electric fields caused by magnetic induction (those are not curl-free, this one is, see section [Theoretical Basis](#)).



In fact, the field strength is so large that the cable would not work; it is way above the level for electrical breakdown in air (which is about 3 kV/mm). These high levels occur in singularities that are located on sharp corners with contrasting material properties. Close to the main conductors this effect occurs too, certainly if you would model their individual strands explicitly. This is one of the main reasons for having the semi-conductive compound; it smoothens the electric field and prevents breakdown.

Displacement Current Density Norm (ec)

- 1 In the **Model Builder** window, right-click **Electric Field Norm (ec)** and choose **Duplicate**.
- 2 In the **Settings** window for **2D Plot Group**, type Displacement Current Density Norm (ec) in the **Label** text field.

Surface 1

- 1 In the **Model Builder** window, expand the **Displacement Current Density Norm (ec)** node, then click **Surface 1**.
- 2 In the **Settings** window for **Surface**, locate the **Expression** section.

- 3 In the **Expression** text field, type `sqrt(abs(ec.Jdx)^2+abs(ec.Jdy)^2)`.
- 4 Select the **Description** check box.
- 5 In the associated text field, type `Displacement current density norm`.
- 6 In the **Displacement Current Density Norm (ec)** toolbar, click  **Plot**.
- 7 Click the  **Zoom Extents** button in the **Graphics** toolbar.

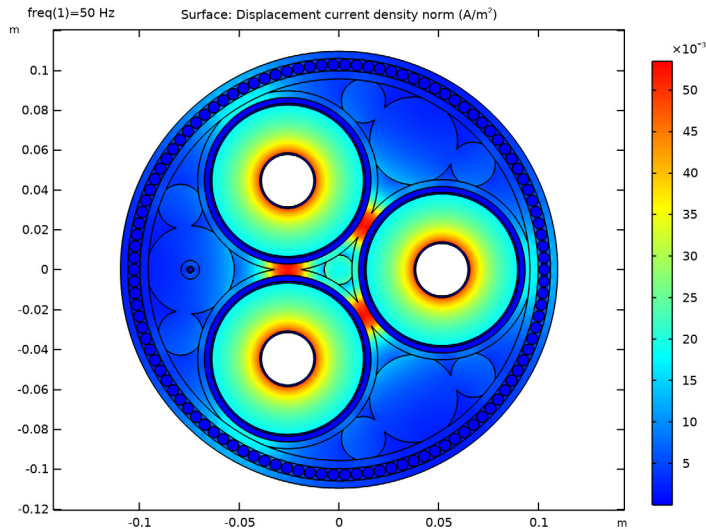



For many quantities, predefined variables are available. You can find them using the buttons in the top-right corner of the **Expression** section, just above the text input field for the expression. There is some autocompletion functionality too (try pressing Ctrl+Space with the text input field in focus). For the displacement current density norm, however, there is no predefined variable, so you had to insert your own definition.

The variables `ec.Jdx` and `ec.Jdy` are the x and y -component of the 2D complex displacement current field, where the prefix “`ec.`” refers to the physics interface responsible for defining it; Electric Currents. The norm of a complex vector field is defined as $\|\mathbf{J}_d\| = (|J_{d,x}|^2 + |J_{d,y}|^2)^{1/2}$. You can use the same approach for the conduction (or induced) current density norm.

Conduction Current Density Norm (ec)

- 1 In the **Model Builder** window, right-click **Displacement Current Density Norm (ec)** and choose **Duplicate**.
- 2 In the **Settings** window for **2D Plot Group**, type `Conduction Current Density Norm (ec)` in the **Label** text field.

Surface 1

- 1 In the **Model Builder** window, expand the **Conduction Current Density Norm (ec)** node, then click **Surface 1**.
- 2 In the **Settings** window for **Surface**, locate the **Expression** section.
- 3 In the **Expression** text field, type $\sqrt{\text{abs}(\text{ec}.\text{Jix})^2 + \text{abs}(\text{ec}.\text{Jiy})^2}$, that is, replace “d” with “i”.
- 4 In the **Description** text field, type Conduction current density norm.
- 5 In the **Conduction Current Density Norm (ec)** toolbar, click  **Plot**.
- 6 Click the  **Zoom Extents** button in the **Graphics** toolbar.

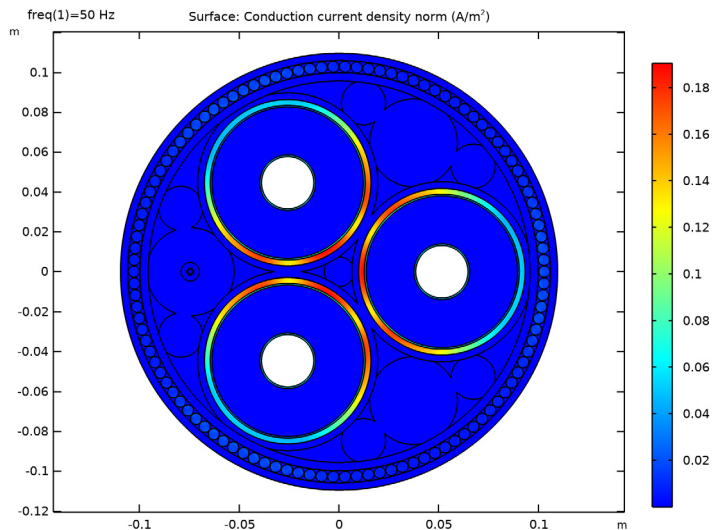

Please note that the displacement currents are negligible in the conductors, including the semi-conductive compound. Likewise, the conduction currents are negligible in the insulators. For all intents and purposes, it is accurate to consider the XLPE a *perfect capacitor* and the semi-conductive compound a *perfect resistor*. Therefore, the conductivity of the XLPE could just as well have been zero. The same goes for the semi-conductive compound's permittivity.

Next, let us see if we can gain more insight in the phase dependency of the solution, by creating a nice animation.

Height Expression 1

- 1 In the **Model Builder** window, right-click **Surface 1** and choose **Height Expression**.
- 2 In the **Electric Potential (ec)** toolbar, click  **Plot**.

3 Click the  **Go to Default View** button in the **Graphics** toolbar.

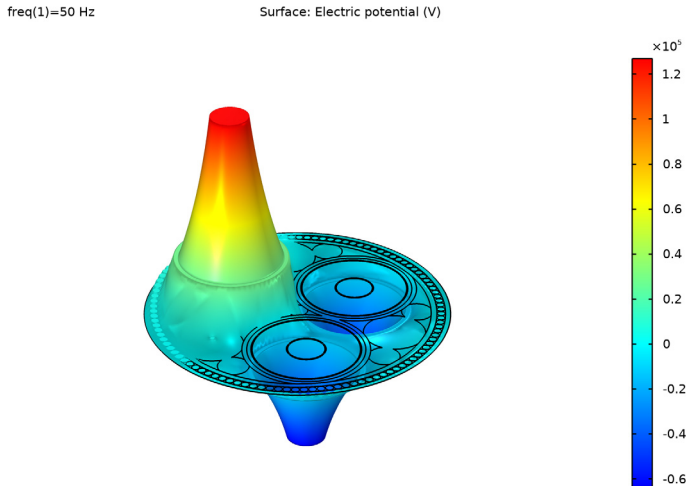

Animation 1

- 1 In the **Results** toolbar, click  **Animation** and choose **Player**.
- 2 In the **Settings** window for **Animation**, locate the **Animation Editing** section.
- 3 From the **Sequence type** list, choose **Dynamic data extension**.
- 4 Locate the **Frames** section. In the **Number of frames** text field, type 60.
- 5 Locate the **Playing** section. From the **Repeat** list, choose **Forever**.
- 6 Right-click **Animation 1** and choose **Play** (see the animation from reference [2]).

Hint: If generating the animation takes too long on your machine, change the quality/resolution setting of the corresponding surface plot from fine to coarse.

One thing to notice is that the metals (that have been put to $5[\text{S/m}]$) indeed manage to behave like equipotential domains, as they should. Furthermore, the screen is floating freely between the phase (the central conductor) and the environment. This goes for the individual armor wires too. Clearly, this behavior is not as intended; the screen should be grounded. Let us see if this is still the case, even at a distance of ten kilometers from the ground point. For this, we will introduce some new parameters.

- 7 Click the **Stop** button in the **Graphics** toolbar.

GLOBAL DEFINITIONS

Electromagnetic Parameters

- 1 In the **Model Builder** window, under **Global Definitions** click **Electromagnetic Parameters**.
- 2 In the **Settings** window for **Parameters**, locate the **Parameters** section.
- 3 In the table, enter the following settings:

Name	Expression	Description
Vdcon	$I0 * Lcab * 53 [\text{mohm/km}]$	Voltage drop across phase (approximate)
Vrpbs	$((Icpha * Lcab) / 2 * Rpbs * Lcab) + 473 [V]$	Voltage raise across screen (approximate)

Here, $53 [\text{mohm/km}]$ refers to the AC resistance per phase as given by the *Inductive Effects* tutorial. This resistance is far more dominant than the cable’s capacitance or inductance (those are on the order of μF and tenths of mH). Multiplying with the total length and the rated current gives an educated guess for the voltage drop; about 490 V.

For the voltage raise in the lead sheath we assume a worst-case scenario: single-point bonding with all voltage inducing effects in-phase. From the *Bonding Capacitive* tutorial we have the expression $(Icpha * Lcab) / 2 * Rpbs * Lcab$, giving the voltage induced by the charging currents (about 83 V). The remaining part, 473 V, is caused by inductive phenomena. The value has been determined half-way the *Bonding Inductive* tutorial.

- 4 In the table, enter the following settings:

Name	Expression	Description
V1	$V0 - Vdcon$	Phase to ground voltage (after 10km)
V2	$0 + Vrpbs$	Screen to ground voltage (after 10km)

You might feel we are thinking in circles here: Proving a point using data from other models that have been justified using the results from this one. This is where the *qualitative assessment* comes into play: The proof will still hold, even if the educated guess for the voltages is off by 100%. *Feel free to check this.*

So the potential in the central conductor is more or less $V0$, the potential in the screen is more or less grounded. Let us put it in the model and recompute.

ELECTRIC CURRENTS (EC)

Phase 1

- 1 In the **Model Builder** window, under **Component 1 (comp1)>Electric Currents (ec)** click **Phase 1**.
- 2 In the **Settings** window for **Terminal**, locate the **Terminal** section.
- 3 In the V_0 text field, type V1.

Screen 1

- 1 Right-click **Phase 1** and choose **Duplicate**.
- 2 In the **Settings** window for **Terminal**, type Screen 1 in the **Label** text field.
- 3 Select Domain 55 only.

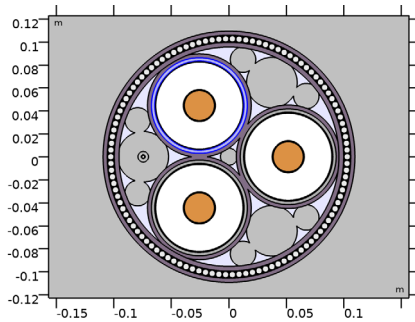

- 4 Locate the **Terminal** section. In the V_0 text field, type V2.

Phase 2

- 1 In the **Model Builder** window, click **Phase 2**.
- 2 In the **Settings** window for **Terminal**, locate the **Terminal** section.
- 3 In the V_0 text field, type $V1 * \exp(-120[\text{deg}] * j)$, that is; replace “V0” with “V1”.

Screen 2

- 1 Right-click **Phase 2** and choose **Duplicate**.
- 2 In the **Settings** window for **Terminal**, type Screen 2 in the **Label** text field.

3 Select Domain 101 only.

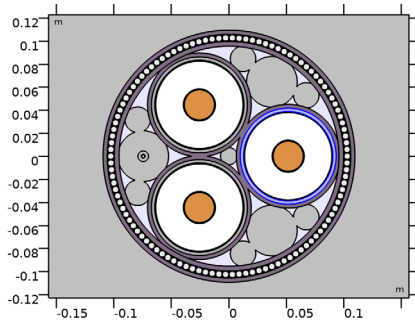

4 Locate the **Terminal** section. In the V_0 text field, type $V2*\exp(-120[\text{deg}]*j)$.

Phase 3

1 In the **Model Builder** window, click **Phase 3**.

2 In the **Settings** window for **Terminal**, locate the **Terminal** section.

3 In the V_0 text field, type $V1*\exp(+120[\text{deg}]*j)$.

Screen 3

1 Right-click **Phase 3** and choose **Duplicate**.

2 In the **Settings** window for **Terminal**, type Screen 3 in the **Label** text field.

3 Select Domain 54 only.

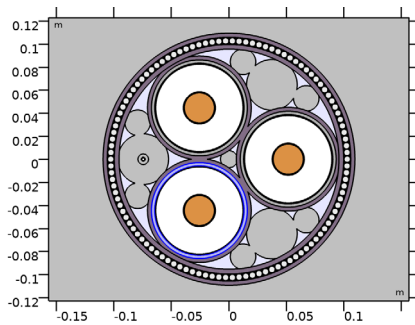



4 Locate the **Terminal** section. In the V_0 text field, type $V2*\exp(+120[\text{deg}]*j)$.

STUDY 1

In the **Home** toolbar, click  **Compute**.

RESULTS

Electric Potential (ec)

- 1 In the **Electric Potential (ec)** toolbar, click  **Plot**.
- 2 Click the  **Go to Default View** button in the **Graphics** toolbar.

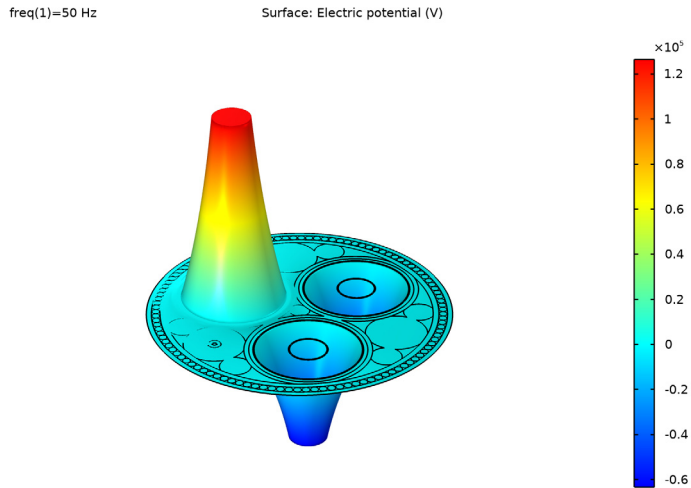

Apart from the XLPE, the cable is starting to look like an equipotential. *Hint; you can investigate the phase dependency by playing the corresponding animation, also available as reference [3].*

Let us inspect the areas outside the screen, by changing the selection applied to the solution.



Selection

- 1 In the **Model Builder** window, click **Selection**.
- 2 In the **Settings** window for **Selection**, locate the **Geometric Entity Selection** section.
- 3 From the **Selection** list, choose **Insulators (External to Phase)**.

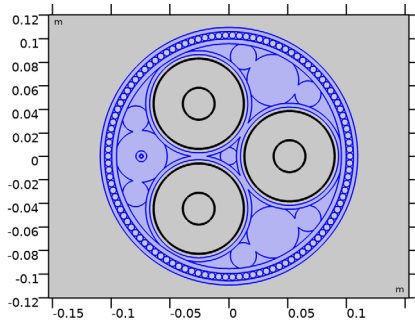
4 Click the  **Zoom to Selection** button in the **Graphics** toolbar.



Electric Potential (ec)

- 1 In the **Model Builder** window, click **Electric Potential (ec)**.
- 2 In the **Electric Potential (ec)** toolbar, click  **Plot**.
- 3 Click the  **Go to Default View** button in the **Graphics** toolbar.

freq(1)=50 Hz

Surface: Electric potential (V)

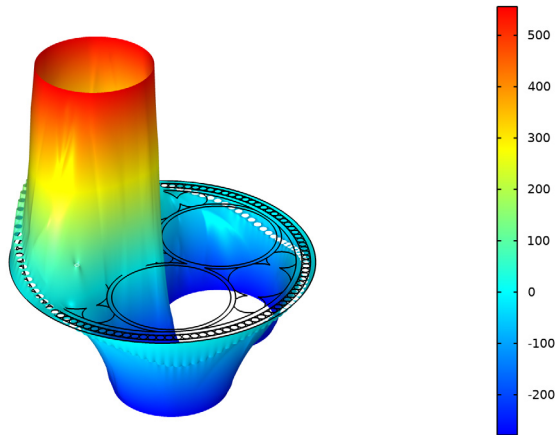

This is a worst-case scenario though. In practice, capacitive and inductive effects will show a 90° phase shift with respect to resistive effects, in opposite directions even.

One detail you might point out is that since the armor is twisted, all armor wires should have the same potential (that is, the armor as a whole should behave like an equipotential). You can achieve this by applying a single terminal to the entire group of armor wires, and setting its excitation form to **Current excitation** with zero current.

All armor wires will then behave like one entity, introducing a total net current of zero Ampère, as floating conductors do. It will not make any difference to the final result though (the lumped parameters). Let us see how this adjusted model compares to the analytical results (and the specifications).

Phase AC Capacitance

- 1 In the **Results** toolbar, click  **Global Evaluation**.
- 2 In the **Settings** window for **Global Evaluation**, type Phase AC Capacitance in the **Label** text field.
- 3 Locate the **Expressions** section. In the table, enter the following settings:

Expression	Unit	Description
$(\text{imag}(\text{ec.Y11}) / \text{ec.omega}) / 1 [\text{m}]$	uF/km	Phase 1 capacitance
$(\text{imag}(\text{ec.Y22}) / \text{ec.omega}) / 1 [\text{m}]$	uF/km	Phase 2 capacitance
$(\text{imag}(\text{ec.Y33}) / \text{ec.omega}) / 1 [\text{m}]$	uF/km	Phase 3 capacitance
Cpha	uF/km	Capacitance per phase (analytic)

Here, `ec.Y11` is one of the elements of the *admittance matrix*. The numbers refer to the terminal numbers. This particular variable refers to the current through **Terminal 1**, divided by the voltage on **Terminal 1**.

Selecting the imaginary part and dividing by `ec.omega`, gives you the capacitance for that terminal. Since this is a 2D model, with the default out-of-plane thickness of one meter applied, the capacitance is divided by `1 [m]`. `Cpha` is the analytical value for comparison.

- 4 Click  **Evaluate**.

TABLE

- 1 Go to the **Table** window.

The results should be around 0.14 μF/km for all three phases (as given by the specifications). As you can see, there is some capacitive pollution from the external insulators in the third or fourth significant digit (that is the effect of single-point bonding and ten kilometers of cable). If we would set `V1` equal to `V0` and `V2` to 0 V, the results would be identical to the analytically determined value up to the sixth significant digit or so (mainly because the mesh does not produce perfect circles).

What this result tells us is that COMSOL is capable of reproducing analytical results. As pointed out in section [On Accuracy](#), this does not necessarily mean it reproduces

measurement results up to the seventh digit. In other words, it does not mean the *significance* is up to the seventh digit. Something similar goes for the currents.

RESULTS

Phase Charging Current

- 1 In the **Results** toolbar, click  **Global Evaluation**.
- 2 In the **Settings** window for **Global Evaluation**, type Phase Charging Current in the **Label** text field.
- 3 Locate the **Expressions** section. In the table, enter the following settings:

Expression	Unit	Description
$\text{abs}(\text{ec.I0_1})/1[\text{m}]$	A/km	Phase 1 charging current
$\text{abs}(\text{ec.I0_2})/1[\text{m}]$	A/km	Phase 2 charging current
$\text{abs}(\text{ec.I0_3})/1[\text{m}]$	A/km	Phase 3 charging current
Icpha	A/km	Charging current per phase (analytic)

- 4 Click  **Evaluate**.

TABLE

- 1 Go to the **Table** window.

The results should be around 5.5 A/km. Furthermore, notice the current density involved is quite small (on the order of 0.06 A/m^2). In order to see this, restore the selection applied to the solution:

RESULTS

Selection

- 1 In the **Model Builder** window, under **Results>Datasets>Study I/Solution I (sol1)** click **Selection**.
- 2 In the **Settings** window for **Selection**, locate the **Geometric Entity Selection** section.
- 3 From the **Selection** list, choose **Cable Domains**.

4 Click the  **Zoom to Selection** button in the **Graphics** toolbar.

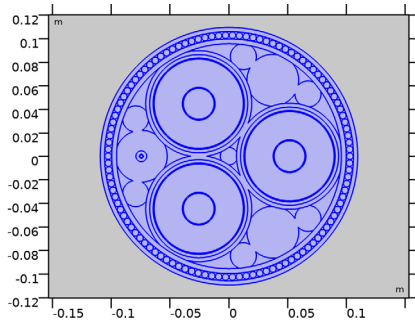

Displacement Current Density Norm (ec)

1 In the **Model Builder** window, click **Displacement Current Density Norm (ec)**.

2 In the **Displacement Current Density Norm (ec)** toolbar, click  **Plot**.

3 Click the  **Zoom Extents** button in the **Graphics** toolbar.

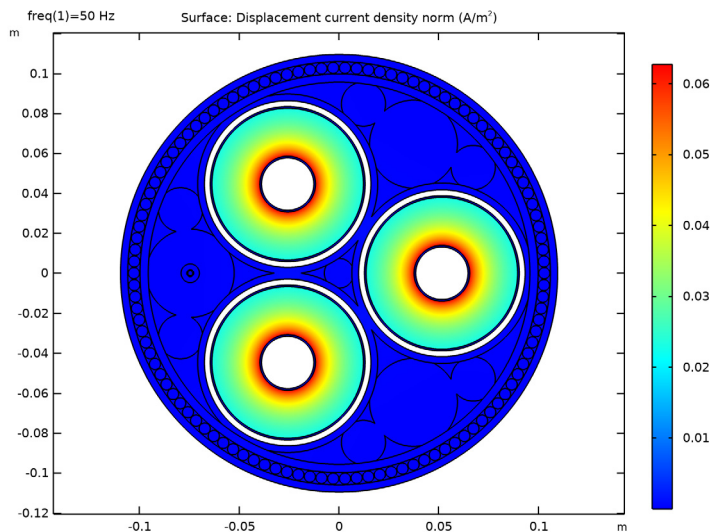

This current density is about $2.95 \cdot 10^7$ smaller than the expected average out-of-plane current density in the main conductors (as given by I_0/A_{con}).

This tells us two things: For one, we may neglect this current density in the *Inductive Effects* tutorial. Secondly, 3D models will usually end up focusing on the inductive part of the device. The fact that this current density has any effect at all comes from the cable's

large longitudinal surface area. This topic is treated in more detail in the *Bonding Capacitive* tutorial.

Another thing to notice is that the displacement current plot shows no currents in the terminals. Halfway the tutorial, you have set the conductivity of the metals to 5 S/m, to make the problem *well-posed*. Another approach is to exclude the metal from the model altogether and consider its potential truly uniform. This is what the **Terminal** and **Floating Potential** features do; they model perfect conductors (see section [On Ill-Posed Problems](#)).

Lastly, you have seen that this model contains a detailed geometry and an elaborate list of material properties. In the end, only one material property has been of any significance: ϵ_{xlpe} . Additionally, only two geometrical properties have been important: R_1 and R_2 (the inner and outer radius of the XLPE respectively). Often-times, you will encounter situations where it is unclear exactly what is important and what may be neglected. *A little numerical exploration can do wonders, even when you do not have the exact figures at hand.*

You have now completed this tutorial, subsequent tutorials will refer to the resulting file as `submarine_cable_02_capacitive_effects.mph`. The next tutorial in this series will investigate bonding types from a capacitive viewpoint.

From the **File** menu, choose **Save**.