

Magnetic Signature of a Submarine

Introduction

A vessel traveling on the surface or under water gives rise to detectable local disturbances in the Earth's magnetic field. These disturbances can be used to trigger weapon systems. The magnetic signature of a ship can be reduced by generating a counteracting magnetic field of suitable strength and direction based on prior knowledge of the magnetic properties of the vessel. An important step in the design of a naval ship is therefore to predict its magnetic signature. Another application where magnetic signatures are of great importance is in urban traffic control: magnetic sensors, buried in our streets, are used to sense vehicles and control traffic lights.

Ships and cars are both to a large extent made of sheet metal. This makes them hard to simulate using standard finite element analysis because volume meshes of thin extended structures are difficult to generate and tend to become very large. This application demonstrates a powerful technique that circumvents the problem by modeling the sheet metal as 2D faces embedded in a 3D geometry. Thus it is only necessary to create comparatively inexpensive 2D face meshes in addition to the 3D volume mesh used for the surrounding medium. A tangential projection of the 3D equation is then solved on the 2D face mesh.



Figure 1: Submarine HMAS Collins. Image courtesy of Kockums AB.

This application also demonstrates the use of the *reduced field formulation* available in the AC/DC Module. This feature provides a convenient way to obtain the magnetic signature of the submarine by allowing the user to define the background field as a predefined quantity and solving only for the perturbations in this field.

Model Definition

In magnetostatic problems, where no currents are present, the problem can be solved using a scalar magnetic potential. This application demonstrates a special technique for modeling thin sheets of high permeability materials, and also shows the use of the reduced field formulation in the AC/DC Module for conveniently modeling perturbations in a known background field.

The model geometry is shown in [Figure 2](#) and consists of face objects representing the submarine. A 3D box representing the surrounding water encloses the vessel.

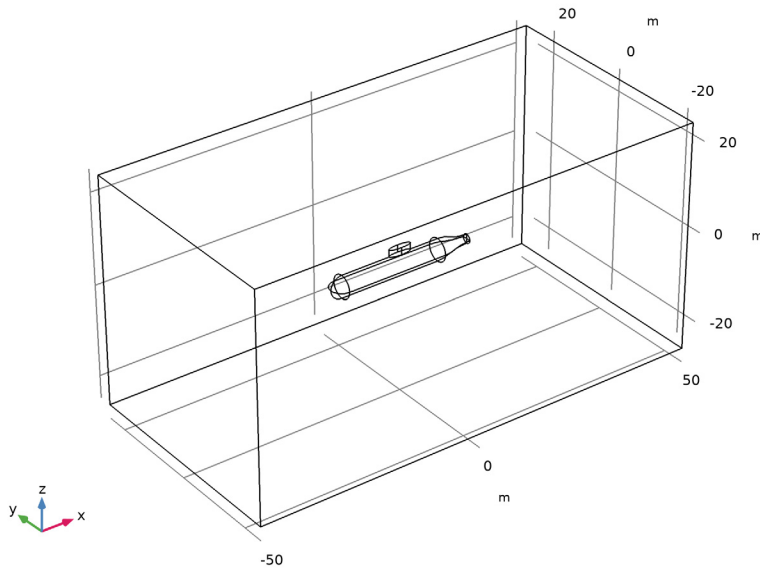

Figure 2: The model geometry.

DOMAIN EQUATIONS

In a current-free region, where

$$\nabla \times \mathbf{H} = \mathbf{0}$$

it is possible to define the scalar magnetic potential, V_m , from the relation

$$\mathbf{H} = -\nabla V_m$$

This is analogous to the definition of the electric potential for static electric fields. Using the constitutive relation between the magnetic flux density and magnetic field

$$\mathbf{B} = \mu_0\mu_r\mathbf{H}$$

together with the equation

$$\nabla \cdot \mathbf{B} = 0$$

you can derive an equation for V_m ,

$$-\nabla \cdot (\mu_0\mu_r\nabla V_m) = 0$$

In this model you use the reduced field formulation, which means that you only solve for the potential V_m corresponding to the perturbation (reduced) field, so the equation you solve reads

$$-\nabla \cdot (\mu_0\mu_r\nabla V_m + \mathbf{B}_{\text{ext}}) = 0$$

where \mathbf{B}_{ext} is a known background field, in this case the Earth's magnetic field of 0.5 G.

Boundary Conditions

The exterior boundaries of the box are insulating for the reduced magnetic field:

$$-\mathbf{n} \cdot \mathbf{B}_{\text{red}} = 0$$

On the face objects representing the hull of the submarine, you apply a 2D tangential projection of the 3D domain equation where the thickness and permeability of the hull are introduced as parameters. This is readily available in the used formulation as a shielding boundary condition, which is useful for modeling of highly permeable thin sheets. Corresponding boundary conditions are available in the Electric Currents and Electrostatics interfaces for modeling of thin sheets with high conductance and high permittivity respectively.

Results and Discussion

Figure 3 shows the total magnetic flux density in a horizontal slice plot 12.5 m below the keel of the submarine. A distinct field perturbation due to the presence of the vessel can be seen. The magnitude and direction of the tangential magnetic field in the hull of the vessel is shown using arrows. The reduced field is visualized as isolevels of the reduced

magnetic potential. This gives a good picture of the perturbation caused by the presence of the submarine in the background field.

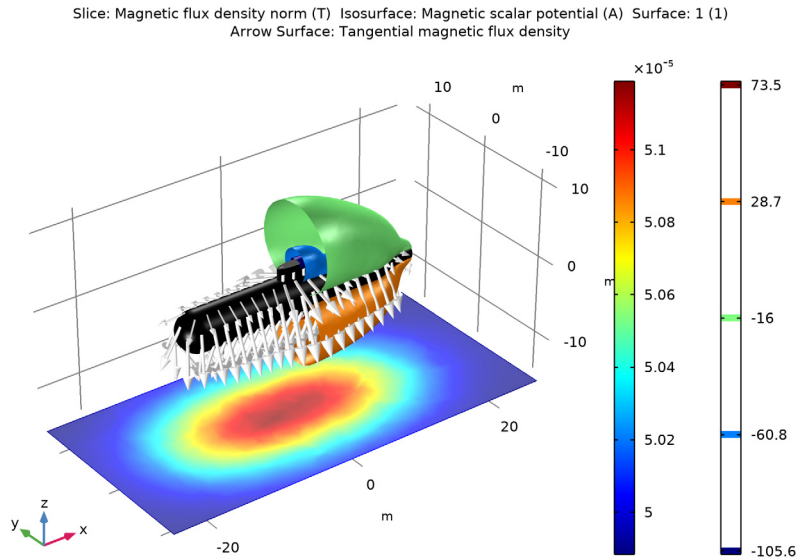



Figure 3: The slice color plot shows the total magnetic flux density (right color legend). The arrows show the direction and strength of the tangential magnetic field in the hull. The isolevels show the reduced magnetic potential (left color legend).

Application Library path: ACDC_Module/Magnetostatics/submarine

Modeling Instructions



From the **File** menu, choose **New**.

NEW

In the **New** window, click  **Model Wizard**.

MODEL WIZARD

1 In the **Model Wizard** window, click  **3D**.

- 2 In the **Select Physics** tree, select **AC/DC>Magnetic Fields, No Currents>Magnetic Fields, No Currents (mfnc)**.
- 3 Click **Add**.
- 4 Click  **Study**.
- 5 In the **Select Study** tree, select **General Studies>Stationary**.
- 6 Click  **Done**.

GEOMETRY I

Define a parameter for the strength of the geomagnetic field.

GLOBAL DEFINITIONS

Parameters I

- 1 In the **Model Builder** window, under **Global Definitions** click **Parameters I**.
- 2 In the **Settings** window for **Parameters**, locate the **Parameters** section.
- 3 In the table, enter the following settings:

Name	Expression	Value	Description
gB	-5e-5[T]	-5E-5 T	Geomagnetic field

GEOMETRY I

Insert the geometry sequence from the submarine_geom_sequence.mph file.

- 1 In the **Geometry** toolbar, click  **Insert Sequence**.
- 2 Browse to the model's Application Libraries folder and double-click the file submarine_geom_sequence.mph.

Submarine (uni I)

Check the 'Resulting objects selection' option to define a 'Boundary selection' which corresponds to the submarine hull for later use.

- 1 In the **Model Builder** window, under **Component I (comp1)>Geometry I** click **Submarine (uni I)**.
- 2 In the **Settings** window for **Union**, locate the **Selections of Resulting Entities** section.
- 3 Select the **Resulting objects selection** check box.
- 4 From the **Show in physics** list, choose **Boundary selection**.

Form Union (fin)

- 1 In the **Geometry** toolbar, click  **Build All**.
Hide the boundaries of the water domain to show only the submarine.
- 2 In the **Model Builder** window, click **Form Union (fin)**.
- 3 In the **Graphics** toolbar, click the **Click and Hide** button.
- 4 In the **Graphics** toolbar, click the **Select Boundaries** button.
- 5 Select the exterior boundaries of the box (boundaries 1–5 and 27).
- 6 In the **Graphics** toolbar, click the **Click and Hide** button again to deactivate it.

MATERIALS

Domain material

- 1 In the **Model Builder** window, under **Component 1 (comp1)** right-click **Materials** and choose **Blank Material**.
- 2 In the **Settings** window for **Material**, type *Domain material* in the **Label** text field.
- 3 Click to expand the **Material Properties** section. In the **Material properties** tree, select **Basic Properties>Relative Permeability**.
- 4 Click  **Add to Material**.
- 5 Locate the **Material Contents** section. In the table, enter the following settings:

Property	Variable	Value	Unit	Property group
Relative permeability	mur_iso ; murii = mur_iso, murij = 0	1	l	Basic

Hull metal

- 1 Right-click **Materials** and choose **Blank Material**.
- 2 In the **Settings** window for **Material**, type *Hull metal* in the **Label** text field.
Select the boundary selection named as 'Submarine' as defined earlier.
- 3 Locate the **Geometric Entity Selection** section. From the **Geometric entity level** list, choose **Boundary**.
- 4 From the **Selection** list, choose **Submarine**.
- 5 Click to expand the **Material Properties** section. In the **Material properties** tree, select **Basic Properties>Relative Permeability**.

6 Click  **Add to Material**.

7 Locate the **Material Contents** section. In the table, enter the following settings:

Property	Variable	Value	Unit	Property group
Relative permeability	mur_iso ; murii = mur_iso, murij = 0	700	l	Basic

MAGNETIC FIELDS, NO CURRENTS (MFNC)

Apply a background magnetic field corresponding to Earth's geomagnetic field.

- 1 In the **Model Builder** window, under **Component 1 (comp1)** click **Magnetic Fields, No Currents (mfnc)**.
- 2 In the **Settings** window for **Magnetic Fields, No Currents**, locate the **Background Magnetic Field** section.
- 3 From the **Solve for** list, choose **Reduced field**.
- 4 Specify the \mathbf{H}_b vector as

0	x
0	y
gB/μ_0_{const}	z

The **External Magnetic Flux Density** feature imposes boundary conditions matching the specified background field.

External Magnetic Flux Density 1

- 1 In the **Physics** toolbar, click  **Boundaries** and choose **External Magnetic Flux Density**.
- 2 In the **Settings** window for **External Magnetic Flux Density**, locate the **Boundary Selection** section.
- 3 From the **Selection** list, choose **All boundaries**.

The **Magnetic Shielding** feature models a thin layer of high permittivity material, such as the metal constituting the submarine hull.

Magnetic Shielding 1

- 1 In the **Physics** toolbar, click  **Boundaries** and choose **Magnetic Shielding**.
- 2 In the **Settings** window for **Magnetic Shielding**, locate the **Boundary Selection** section.
- 3 From the **Selection** list, choose **Submarine**.

4 Locate the **Magnetic Shielding** section. In the d_s text field, type 0.05.

MESH I

1 In the **Model Builder** window, under **Component 1 (comp1)** click **Mesh I**.

2 In the **Settings** window for **Mesh**, locate the **Physics-Controlled Mesh** section.

3 From the **Element size** list, choose **Finer**.

These settings will adequately resolve the region around the submarine hull.

4 Click  **Build All**.

STUDY I

Disable the automatic generation of default plots. Instead, you will create a custom plot when the solver has finished.

1 In the **Model Builder** window, click **Study I**.

2 In the **Settings** window for **Study**, locate the **Study Settings** section.

3 Clear the **Generate default plots** check box.

4 In the **Home** toolbar, click  **Compute**.

RESULTS

3D Plot Group 1

1 In the **Model Builder** window, expand the **Results** node.

2 Right-click **Results** and choose **3D Plot Group**.

3 In the **Settings** window for **3D Plot Group**, locate the **Plot Settings** section.

4 Clear the **Plot dataset edges** check box.

Slice 1

1 Right-click **3D Plot Group 1** and choose **Slice**.

2 In the **Settings** window for **Slice**, click **Replace Expression** in the upper-right corner of the **Expression** section. From the menu, choose **Component 1 (comp1)>Magnetic Fields, No Currents>Magnetic>mfnc.normB - Magnetic flux density norm - T**.

3 Locate the **Plane Data** section. From the **Plane** list, choose **xy-planes**.

4 From the **Entry method** list, choose **Coordinates**.

5 In the **z-coordinates** text field, type -15.

Add a filter to plot the slice only in proximity of the submarine.

Filter 1

- 1 Right-click **Slice 1** and choose **Filter**.
- 2 In the **Settings** window for **Filter**, locate the **Element Selection** section.
- 3 In the **Logical expression for inclusion** text field, type $\text{abs}(x) < (r1 * .8) \&\& \text{abs}(y) < (r1 * 5)$.

Isosurface 1

- In the **Model Builder** window, right-click **3D Plot Group 1** and choose **Isosurface**.
- Add another filter to cut the isosurfaces and show the submarine hull inside.

Filter 1

- 1 In the **Model Builder** window, right-click **Isosurface 1** and choose **Filter**.
- 2 In the **Settings** window for **Filter**, locate the **Element Selection** section.
- 3 In the **Logical expression for inclusion** text field, type $x > 0$.

Surface 1

- 1 In the **Model Builder** window, right-click **3D Plot Group 1** and choose **Surface**.
- 2 In the **Settings** window for **Surface**, locate the **Expression** section.
- 3 In the **Expression** text field, type 1.
- 4 Locate the **Coloring and Style** section. From the **Coloring** list, choose **Uniform**.
- 5 From the **Color** list, choose **Black**.

Arrow Surface 1

- 1 Right-click **3D Plot Group 1** and choose **Arrow Surface**.
- 2 In the **Settings** window for **Arrow Surface**, click **Replace Expression** in the upper-right corner of the **Expression** section. From the menu, choose **Component 1 (comp1) > Magnetic Fields, No Currents > Magnetic > mfnc.tBx, ..., mfnc.tBz - Tangential magnetic flux density**.
- 3 Locate the **Coloring and Style** section. From the **Color** list, choose **White**.
- 4 In the **3D Plot Group 1** toolbar, click  **Plot**.

5 Click the  **Go to Default View** button in the **Graphics** toolbar.

The plot shows the effect of the submarine's hull on the geomagnetic field.

