



Static Field Modeling of a Halbach Rotor

Introduction

This example presents the static-field modeling of an outward-flux-focusing magnetic rotor using permanent magnets, a magnetic rotor also known as a Halbach rotor. The use of permanent magnets in rotatory devices such as motors, generators, and magnetic gears is increasing due to their no-contact, frictionless operation. This model illustrates how to calculate the magnetic field of a 4-pole pair rotor in 3D by modeling only a single pole of the rotor using symmetry.

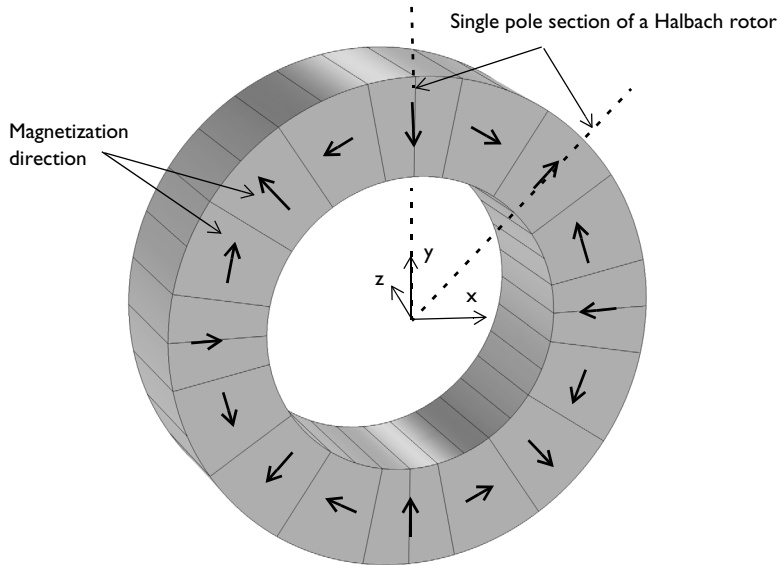

Figure 1: Illustration of a 16-segments, 4-pole pair Halbach rotor. The symmetries of the problem allow restricting the model to a single pole of the rotor.

Model Definition

Set up the problem in a 3D modeling space. Due to symmetry, it is sufficient to model a single pole of the rotor. [Figure 1](#) shows a 3D view of the complete rotor with the magnetization direction of the magnets indicated. The black arrows show the radial and axial magnetization directions of the permanent magnets in the rotor. The permanent magnets are arranged in such a way that the magnetic flux density is minimized inside the rotor and maximized outside the rotor. The model consists of 16 permanent magnet pieces arranged to form a 4-pole pair rotor. The inner and outer rotor radii are 30 mm and 50 mm, respectively. The axial length of the rotor is 30 mm.

Results and Discussion

A steady-state study analysis is performed to calculate the magnetic fields of the Halbach rotor. The magnetic flux density is shown in [Figure 2](#).

[Figure 3](#) and [Figure 4](#) illustrate the variations of the radial and azimuthal magnetic flux density as functions of rotor angle. The magnetic flux density norm is evaluated outside the Halbach rotor at a radial distance of 55 mm from the center.

Finally, [Figure 5](#) and [Figure 6](#) show the polar plots of the magnetic flux density norm at radial distances from the rotor center of 55 mm and 25 mm, respectively.

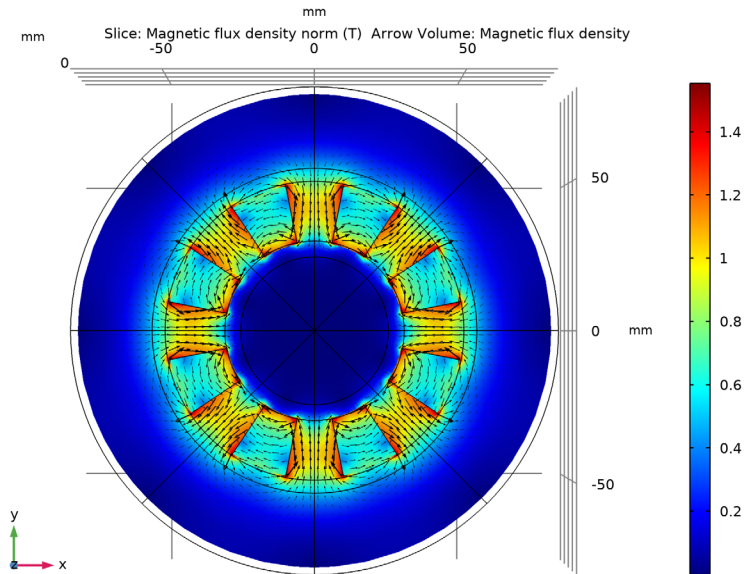

Figure 2: Magnetic flux density norm at the cross section of the Halbach rotor (at $z = 0$ mm).

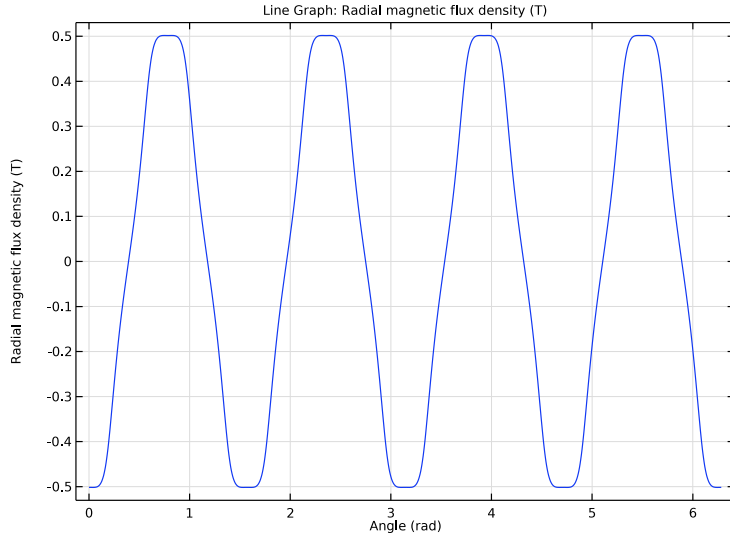

Figure 3: The radial magnetic flux density as a function of rotor angle measured at a radial distance of 55 mm from the rotor center.

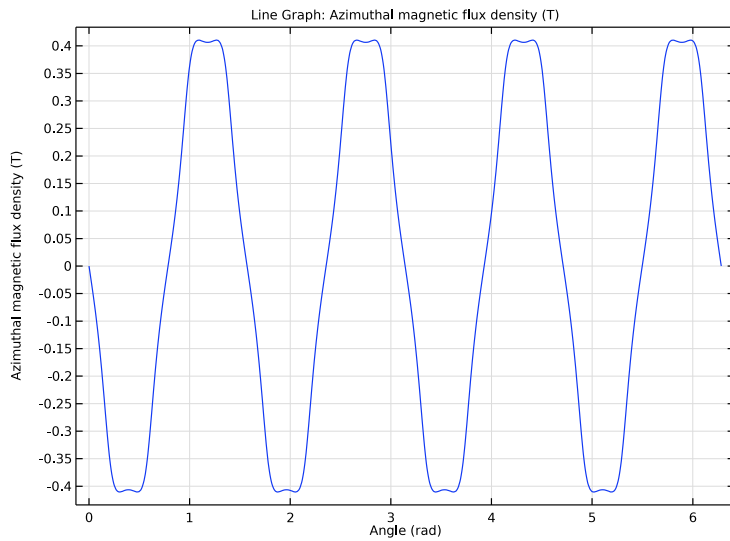

Figure 4: The azimuthal magnetic flux density as a function of rotor angle measured at a radial distance of 25 mm from the rotor center.

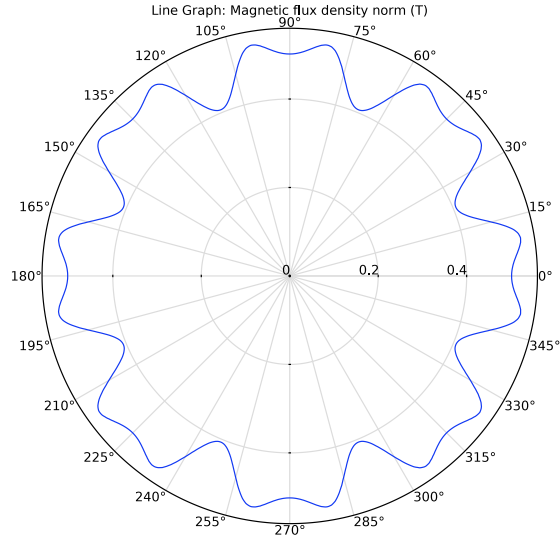

Figure 5: Polar plot of the magnetic flux density norm at a radial distance of 55 mm from the rotor center.

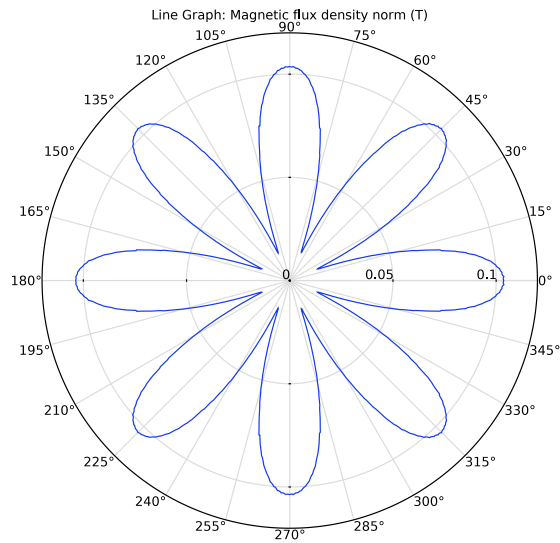



Figure 6: Polar plot of the magnetic flux density norm at a radial distance of 25 mm from the rotor center.

Application Library path: ACDC_Module/Magnetostatics/
static_field_halbach_rotor_3d



Modeling Instructions

From the **File** menu, choose **New**.

NEW



In the **New** window, click  **Model Wizard**.

MODEL WIZARD

- 1 In the **Model Wizard** window, click  **3D**.
- 2 In the **Select Physics** tree, select **AC/DC>Electromagnetic Fields>Magnetic Fields (mf)**.
- 3 Click **Add**.
- 4 Click  **Study**.
- 5 In the **Select Study** tree, select **General Studies>Stationary**.
- 6 Click  **Done**.

GEOMETRY I

Insert the geometry sequence from the
static_field_halbach_rotor_3d_geom_sequence.mph file.

- 1 In the **Geometry** toolbar, click  **Insert Sequence**.
- 2 Browse to the model's Application Libraries folder and double-click the file
static_field_halbach_rotor_3d_geom_sequence.mph.
- 3 In the **Geometry** toolbar, click  **Build All**.
- 4 Click the  **Zoom Extents** button in the **Graphics** toolbar.

5 Click the  **Wireframe Rendering** button in the **Graphics** toolbar.

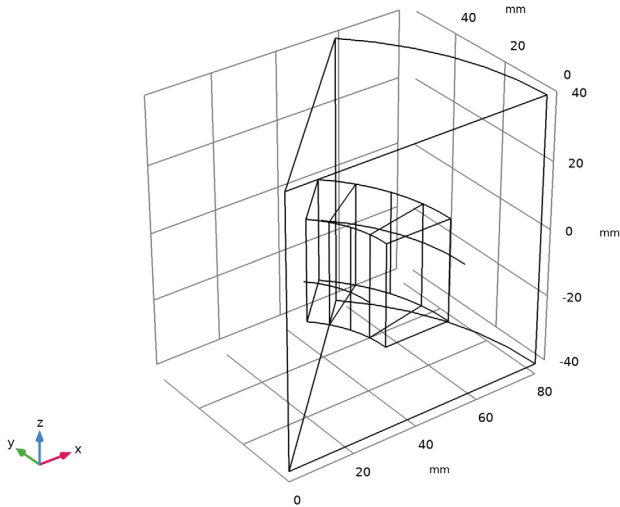

Define variables for the radial and azimuthal magnetic flux densities.

DEFINITIONS

Variables 1

- 1 In the **Home** toolbar, click  **Variables** and choose **Local Variables**.
- 2 In the **Settings** window for **Variables**, locate the **Variables** section.
- 3 In the table, enter the following settings:

Name	Expression	Unit	Description
R	$\sqrt{x^2+y^2}$	m	Radial distance
B_r	$(mf.Bx*x+mf.By*y)/R$	T	Radial magnetic flux density
B_phi	$(-mf.Bx*y+mf.By*x)/R$	T	Azimuthal magnetic flux density

Define a selection for the magnets.

Magnets

- 1 In the **Definitions** toolbar, click  **Explicit**.
- 2 Select Domains 2–4 only.
- 3 Right-click **Explicit 1** and choose **Rename**.

4 In the **Rename Explicit** dialog box, type **Magnets** in the **New label** text field.

5 Click **OK**.

Add a new cylindrical coordinate system. You will use this coordinate system to assign the magnetization of the permanent magnets.

Cylindrical System 2 (sys2)

In the **Definitions** toolbar, click  **Coordinate Systems** and choose **Cylindrical System**.

View 1

Hide a few boundaries to view the results only in the inner part of the model domain.

Hide for Physics 1

1 In the **Model Builder** window, right-click **View 1** and choose **Hide for Physics**.

2 In the **Settings** window for **Hide for Physics**, locate the **Geometric Entity Selection** section.

3 From the **Geometric entity level** list, choose **Boundary**.

4 Select Boundaries 1, 2, and 4 only.

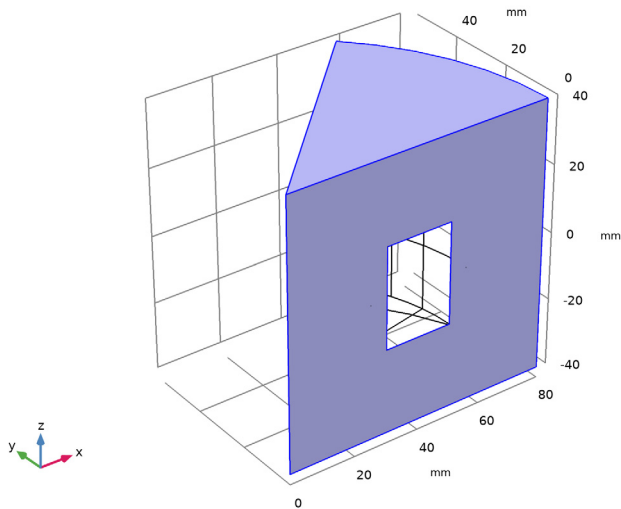

MAGNETIC FIELDS (MF)

Now, set up the **Magnetic Fields** physics. Model the permanent magnets using **Ampère's Law**.

Magnet, outward magnetized

1 In the **Model Builder** window, under **Component 1 (comp1)** right-click

Magnetic Fields (mf) and choose **Ampère's Law**.

- 2 Select Domain 2 only.
- 3 In the **Settings** window for **Ampère's Law**, locate the **Coordinate System Selection** section.
- 4 From the **Coordinate system** list, choose **Cylindrical System 2 (sys2)**.
- 5 Locate the **Constitutive Relation B-H** section. From the **Magnetization model** list, choose **Remanent flux density**.
- 6 In the **Label** text field, type Magnet, outward magnetized.

Magnet, inward magnetized

- 1 In the **Physics** toolbar, click  **Domains** and choose **Ampère's Law**.
- 2 Select Domain 4 only.
- 3 In the **Settings** window for **Ampère's Law**, locate the **Coordinate System Selection** section.
- 4 From the **Coordinate system** list, choose **Cylindrical System 2 (sys2)**.
- 5 Locate the **Constitutive Relation B-H** section. From the **Magnetization model** list, choose **Remanent flux density**.
- 6 Specify the **e** vector as

-1	r
0	phi
0	a

- 7 In the **Label** text field, type Magnet, inward magnetized.





Magnet, counterclock-wise magnetized

- 1 In the **Physics** toolbar, click  **Domains** and choose **Ampère's Law**.
- 2 Select Domain 3 only.
- 3 In the **Settings** window for **Ampère's Law**, locate the **Coordinate System Selection** section.
- 4 From the **Coordinate system** list, choose **Cylindrical System 2 (sys2)**.
- 5 Locate the **Constitutive Relation B-H** section. From the **Magnetization model** list, choose **Remanent flux density**.
- 6 Specify the **e** vector as

0	r
1	phi
0	a

- 7 In the **Label** text field, type Magnet, counterclock-wise magnetized.

ADD MATERIAL

- 1 In the **Home** toolbar, click  **Add Material** to open the **Add Material** window.
- 2 Go to the **Add Material** window.
- 3 In the tree, select **Built-in>Air**.
- 4 Click  **Add to Component I (comp1)**.
- 5 In the tree, select **AC/DC>Hard Magnetic Materials>Sintered NdFeB Grades (Chinese Standard)>N50 (Sintered NdFeB)**.
- 6 Click  **Add to Component I (comp1)**.
- 7 In the **Home** toolbar, click  **Add Material** to close the **Add Material** window.

MATERIALS

N50 (Sintered NdFeB) (mat2)

- 1 In the **Settings** window for **Material**, locate the **Geometric Entity Selection** section.
- 2 From the **Selection** list, choose **Magnets**.

MESH 1

- 1 In the **Model Builder** window, under **Component 1 (comp1)** click **Mesh 1**.
- 2 In the **Settings** window for **Mesh**, locate the **Physics-Controlled Mesh** section.
- 3 From the **Element size** list, choose **Coarse**.

Size 1

- 1 Right-click **Component 1 (comp1)>Mesh 1** and choose **Size**.
- 2 In the **Settings** window for **Size**, locate the **Geometric Entity Selection** section.
- 3 From the **Geometric entity level** list, choose **Domain**.
- 4 From the **Selection** list, choose **Magnets**.
- 5 Locate the **Element Size** section. From the **Predefined** list, choose **Fine**.



Specify a very fine mesh on the curves where the magnetic flux density is to be evaluated. This helps to obtain a smooth curve for magnetic flux density.

Size 2

- 1 In the **Model Builder** window, right-click **Mesh 1** and choose **Size**.
- 2 In the **Settings** window for **Size**, locate the **Geometric Entity Selection** section.
- 3 From the **Geometric entity level** list, choose **Edge**.
- 4 Select Edges 6 and 31 only.
- 5 Locate the **Element Size** section. Click the **Custom** button.

- 6 Locate the **Element Size Parameters** section. Select the **Maximum element size** check box.
- 7 In the associated text field, type 0.5.

Free Tetrahedral I

- 1 In the **Mesh** toolbar, click  **Free Tetrahedral**.
 - 2 In the **Settings** window for **Free Tetrahedral**, click  **Build All**.
- Compare the mesh with the figure shown below.

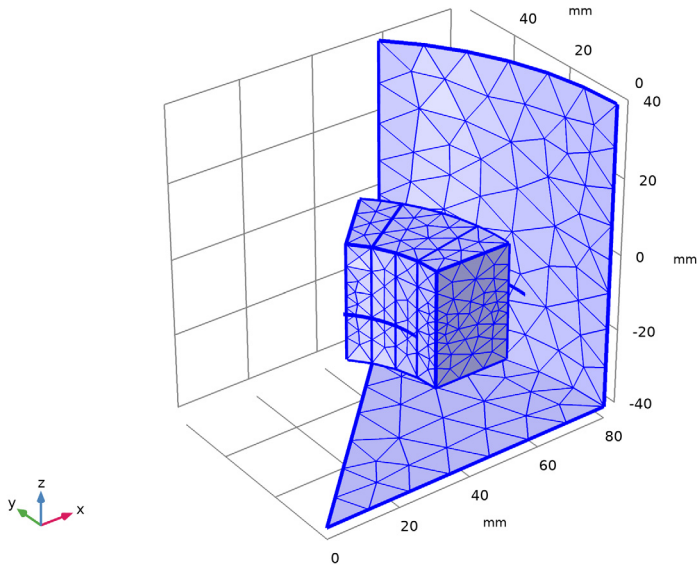

STUDY I

- 1 In the **Model Builder** window, click **Study I**.
- 2 In the **Settings** window for **Study**, locate the **Study Settings** section.
- 3 Clear the **Generate default plots** check box.
- 4 In the **Home** toolbar, click  **Compute**.

RESULTS

Use the Sector 3D dataset to produce a 3D dataset for the complete 3D model from the single-pole results.

Sector 3D I

- 1 In the **Model Builder** window, expand the **Results** node.

- 2 Right-click **Results>Datasets** and choose **More 3D Datasets>Sector 3D**.
- 3 In the **Settings** window for **Sector 3D**, locate the **Symmetry** section.
- 4 In the **Number of sectors** text field, type 8.
- 5 From the **Transformation** list, choose **Rotation and reflection**.
- 6 Click to expand the **Advanced** section. Select the **Define variables** check box.
The **Sector number** will be used later on, to get the right expression for B_{phi} in [Figure 4](#).

Next, construct circles to visualize the magnetic flux density on the inside and the outside of the Halbach rotor.

Parameterized Curve 3D 1

- 1 In the **Results** toolbar, click  **More Datasets** and choose **Parameterized Curve 3D**.
- 2 In the **Settings** window for **Parameterized Curve 3D**, locate the **Data** section.
- 3 From the **Dataset** list, choose **Sector 3D I**.
- 4 Locate the **Parameter** section. In the **Name** text field, type phi .
- 5 In the **Maximum** text field, type $2 \cdot \text{pi}$.
- 6 Locate the **Expressions** section. In the **x** text field, type $55 \cdot \cos(\text{phi})$.
- 7 In the **y** text field, type $55 \cdot \sin(\text{phi})$.

Parameterized Curve 3D 2

- 1 In the **Results** toolbar, click  **More Datasets** and choose **Parameterized Curve 3D**.
- 2 In the **Settings** window for **Parameterized Curve 3D**, locate the **Data** section.
- 3 From the **Dataset** list, choose **Sector 3D I**.
- 4 Locate the **Parameter** section. In the **Name** text field, type phi .
- 5 In the **Maximum** text field, type $2 \cdot \text{pi}$.
- 6 Locate the **Expressions** section. In the **x** text field, type $25 \cdot \cos(\text{phi})$.
- 7 In the **y** text field, type $25 \cdot \sin(\text{phi})$.

Use the following instructions to reproduce the plot shown in [Figure 2](#).



3D Plot Group 1

- 1 In the **Results** toolbar, click  **3D Plot Group**.
- 2 In the **Settings** window for **3D Plot Group**, locate the **Data** section.
- 3 From the **Dataset** list, choose **Sector 3D I**.

Slice 1

- 1 Right-click **3D Plot Group 1** and choose **Slice**.
- 2 In the **Settings** window for **Slice**, locate the **Plane Data** section.
- 3 From the **Plane** list, choose **xy-planes**.
- 4 In the **Planes** text field, type 1.
- 5 In the **3D Plot Group 1** toolbar, click  **Plot**.

Arrow Volume 1

- 1 In the **Model Builder** window, right-click **3D Plot Group 1** and choose **Arrow Volume**.
- 2 In the **Settings** window for **Arrow Volume**, locate the **Arrow Positioning** section.
- 3 Find the **x grid points** subsection. In the **Points** text field, type 60.
- 4 Find the **y grid points** subsection. In the **Points** text field, type 60.
- 5 Find the **z grid points** subsection. In the **Points** text field, type 1.
- 6 Locate the **Coloring and Style** section. From the **Color** list, choose **Black**.
- 7 In the **3D Plot Group 1** toolbar, click  **Plot**.
- 8 Click the  **Go to XY View** button in the **Graphics** toolbar.

Next, generate a plot for the radial magnetic flux density outside the Halbach rotor. Compare the result with [Figure 3](#).

ID Plot Group 2

- 1 In the **Home** toolbar, click  **Add Plot Group** and choose **ID Plot Group**.
- 2 In the **Settings** window for **ID Plot Group**, locate the **Data** section.
- 3 From the **Dataset** list, choose **Parameterized Curve 3D 1**.
- 4 Locate the **Plot Settings** section. Select the **x-axis label** check box.
- 5 In the associated text field, type Angle (rad).

Line Graph 1

- 1 Right-click **ID Plot Group 2** and choose **Line Graph**.
- 2 In the **Settings** window for **Line Graph**, click **Replace Expression** in the upper-right corner of the **y-Axis Data** section. From the menu, choose **Component 1 (comp1)>Definitions>Variables>B_r - Radial magnetic flux density - T**.
- 3 Locate the **x-Axis Data** section. From the **Parameter** list, choose **Expression**.
- 4 In the **Expression** text field, type ϕ .
- 5 In the **ID Plot Group 2** toolbar, click  **Plot**.

Create the azimuthal magnetic flux density plot as shown in [Figure 4](#).

ID Plot Group 3

- 1 In the **Home** toolbar, click  **Add Plot Group** and choose **ID Plot Group**.
- 2 In the **Settings** window for **ID Plot Group**, locate the **Data** section.
- 3 From the **Dataset** list, choose **Parameterized Curve 3D I**.
- 4 Locate the **Plot Settings** section. Select the **x-axis label** check box.
- 5 In the associated text field, type `Angle (rad)`.

Line Graph 1

- 1 Right-click **ID Plot Group 3** and choose **Line Graph**.
- 2 In the **Settings** window for **Line Graph**, locate the **y-Axis Data** section.
- 3 In the **Expression** text field, type `B_phi*(1-2*mod(sec1number,2))`.
- 4 Select the **Description** check box.
- 5 In the associated text field, type `Azimuthal magnetic flux density`.
- 6 Locate the **x-Axis Data** section. From the **Parameter** list, choose **Expression**.
- 7 In the **Expression** text field, type `phi`.
- 8 In the **ID Plot Group 3** toolbar, click  **Plot**.

Here, the expression `B_phi*(1-2*mod(sec1number,2))` perhaps requires some additional clarification: The even sectors of the rotor are mirrored in the `phi` direction, with respect to the odd ones. The original dataset contains the values of `B_phi` for one odd sector only. The added correction term uses the modulus operator; it will flip between `+1` and `-1` every other sector.

The reason **Arrow Volume 1** did not need such data manipulation, is because it considers its input (`mf.Bx`, `mf.By`, `mf.Bz`) a vector field and is able to apply the transformation itself. **Line Graph 1** on the other hand, is in no way capable of relating its input to a certain "direction". It will therefore consider `B_phi` a scalar.

Next, generate the polar plot of the magnetic flux density norm at a distance 55 mm away from the center of the rotor.

Polar Plot Group 4

- 1 In the **Home** toolbar, click  **Add Plot Group** and choose **Polar Plot Group**.
- 2 In the **Settings** window for **Polar Plot Group**, locate the **Data** section.
- 3 From the **Dataset** list, choose **Parameterized Curve 3D I**.
- 4 Locate the **Axis** section. Select the **Manual axis limits** check box.

5 In the **r maximum** text field, type 0.56.

Line Graph 1

- 1 Right-click **Polar Plot Group 4** and choose **Line Graph**.
- 2 In the **Settings** window for **Line Graph**, locate the **θ Angle Data** section.
- 3 From the **Parameter** list, choose **Expression**.
- 4 In the **Expression** text field, type ϕ .
- 5 In the **Polar Plot Group 4** toolbar, click  **Plot**.

Finally, reproduce the plot for the magnetic flux density norm at a distance 25 mm from the rotor center.

Polar Plot Group 5

- 1 In the **Home** toolbar, click  **Add Plot Group** and choose **Polar Plot Group**.
- 2 In the **Settings** window for **Polar Plot Group**, locate the **Data** section.
- 3 From the **Dataset** list, choose **Parameterized Curve 3D 2**.
- 4 Locate the **Axis** section. Select the **Manual axis limits** check box.
- 5 In the **r maximum** text field, type 0.12.

Line Graph 1

- 1 Right-click **Polar Plot Group 5** and choose **Line Graph**.
- 2 In the **Settings** window for **Line Graph**, locate the **θ Angle Data** section.
- 3 From the **Parameter** list, choose **Expression**.
- 4 In the **Expression** text field, type ϕ .
- 5 In the **Polar Plot Group 5** toolbar, click  **Plot**.

Compare this figure with that shown in [Figure 6](#).

