

E-Core Transformer

Introduction

Transformers are electrical components that are used for power transmission. Most transformers work on the principle of electromagnetic induction. A typical transformer consists of a primary coil, a secondary coil and a ferromagnetic core. The primary coil receives the AC electrical input signal. As a result of mutual induction, an induced voltage is obtained across the secondary coil. The ferromagnetic core serves the purpose of a magnetic flux concentrator thereby minimizing losses due to flux leakage.

Commercial transformers use several types of cores, which are named based on their geometric shapes, for example I-core, U-core, E-core, pot core, toroidal, and planar. This application uses a pair of E-cores for magnetic flux concentration.

This example demonstrates how to perform transient simulations of a single-phase E-core transformer. Including the effect of a nonlinear B-H curve in the soft-iron core, the model computes the spatial distribution of the magnetic and electric fields, the magnetic saturation effect, the transient response, and the flux leakage to the surroundings. Two different versions of the transformer are simulated: the first one with a turn ratio of unity and the second one with a turn ratio of 1000.

Model Definition

The core of the single-phase E-core transformer considered here consists of a pair of E-cores, which form a closed magnetic flux path. The primary and secondary coils in the transformer are placed around the central leg of the core as shown in [Figure 1](#).

A nonlinear B-H curve that includes saturation effects is used to simulate the magnetic behavior of the soft-iron core. Hysteresis effects in the core are neglected. The model assumes that the primary and secondary windings are made of thin wire and have multiple turns. Using the assumptions that the wire diameter is less than the skin depth and that there are many turns, these windings are modeled with Coil features. Furthermore, the model does not account for eddy currents in the individual turns of the coil. The primary

winding is connected to a primary resistor, R_p and the AC voltage source, V_{ac} while the secondary winding is connected to the secondary load resistor, R_s as shown in Figure 2.

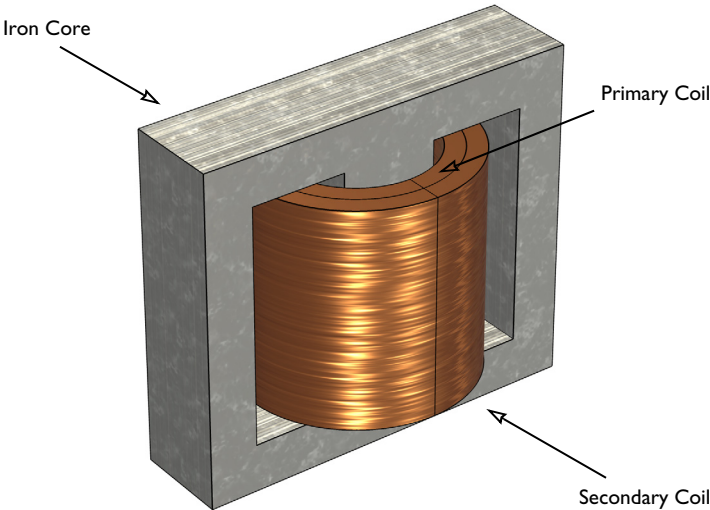

Figure 1: Model illustration of an E-core transformer.

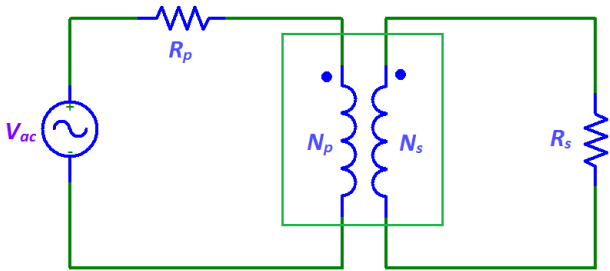

Figure 2: A transformer connected to an external circuit with voltage source and resistors.

The model is solved in time domain for a line frequency of 50 Hz. Several important design parameters such as the magnitude of the input voltage, the line frequency, the number of turns in the coils, and the coil resistance are parameterized and can therefore easily be changed. The models also demonstrate how to use the Loss Calculation feature combined with the Time to Frequency Losses study to compute electromagnetic losses.

A transformer works by the principle of Faraday's law of induction which states that the induced voltage (V_{in}) in a coil is proportional to the rate of change of magnetic flux (ϕ) and the number of turns (N) in a coil as shown in Equation 1.

$$V_{in} = -N \frac{d\phi}{dt} \quad (1)$$

If two coils are coupled, Equation 1 can be used to deduce that the induced voltage in the secondary coil (V_s) is proportional to the induced voltage in the primary coil (V_p):

$$\frac{V_s}{V_p} = \frac{N_s}{N_p} \quad (2)$$

Here N_s and N_p are the number of turns in the secondary and primary coils, respectively. N_p/N_s is known as the turn ratio.

The two versions of the transformer are simulated in Case 1 and Case 2, respectively. The two different groups of the parameters are defined in two Variables nodes such that the model can be easily configured in the Physics and Variables Selection of the Study.

Results and Discussion

Figure 3 shows the surface plot of the magnetic flux density norm distribution and the arrow plots of the currents in the windings at $t = 50$ ms for Case 1.

Figure 4 shows the slice and the arrow plot of the magnetic flux density norm in the core at $t = 50$ ms for Case 1.

Figure 5 compares the induced voltage in the primary and secondary windings for Case 1. Since the number of turns on each winding is equal, the induced voltage in both windings is same as given by Equation 2. The currents flowing through the primary and secondary windings are shown in Figure 6.

Figure 7 displays the voltage induced in the primary and secondary winding for a step-down transformer with a turn ratio of $N_p/N_s = 1000$ and supply voltage of 25 kV (Case 2). This induced voltage is 1000 times smaller compared to the voltage in the primary winding.

Figure 8 compares the iron loss power density in the magnetic core of the transformers for Case 1 and Case 2. With the use of Volume Integration, the total iron loss power is computed to be about 1.1 W and 1.9 W, respectively, for Case 1 and Case 2.

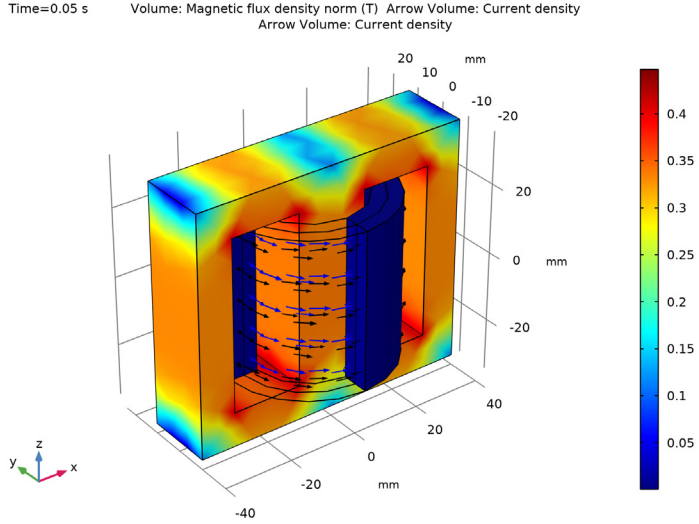

Figure 3: Magnetic flux density norm and the currents in the windings at $t = 50$ ms, Case 1.

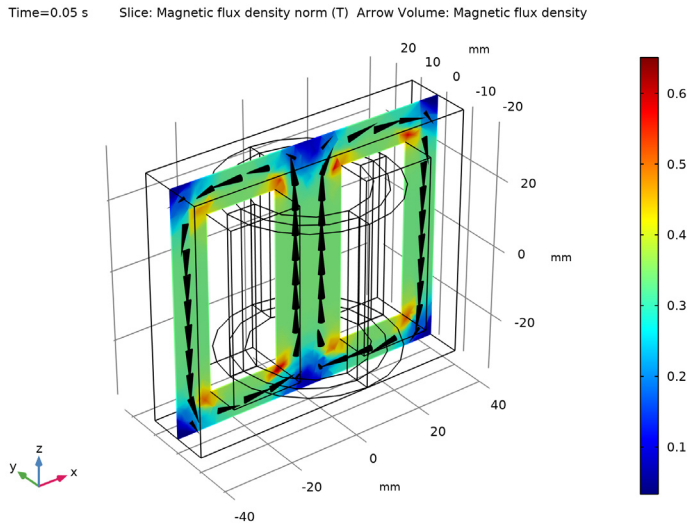

Figure 4: Magnetic flux density inside the transformer core at $t = 50$ ms, Case 1.

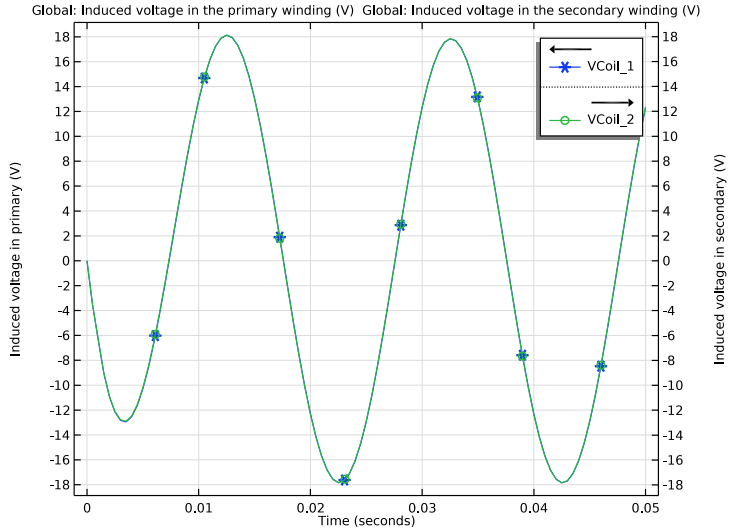

Figure 5: The induced voltage in the windings versus time, Case 1.

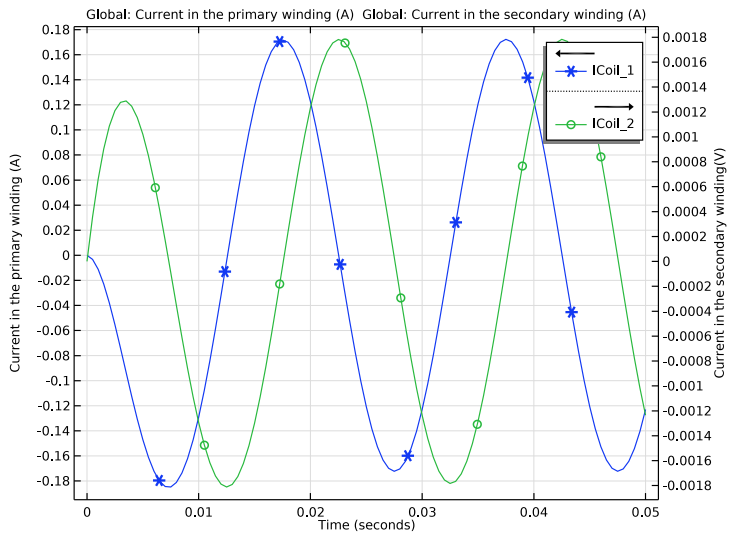

Figure 6: Current in the windings versus time, Case 1.

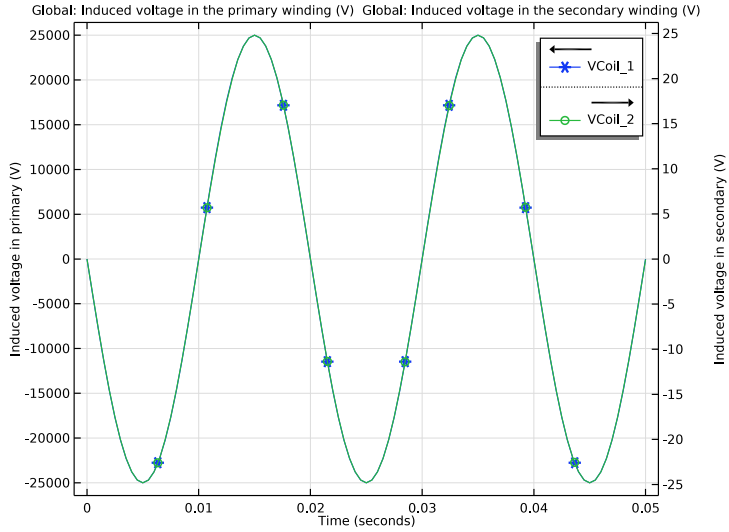

Figure 7: The induced voltage in the windings versus time, Case 2.

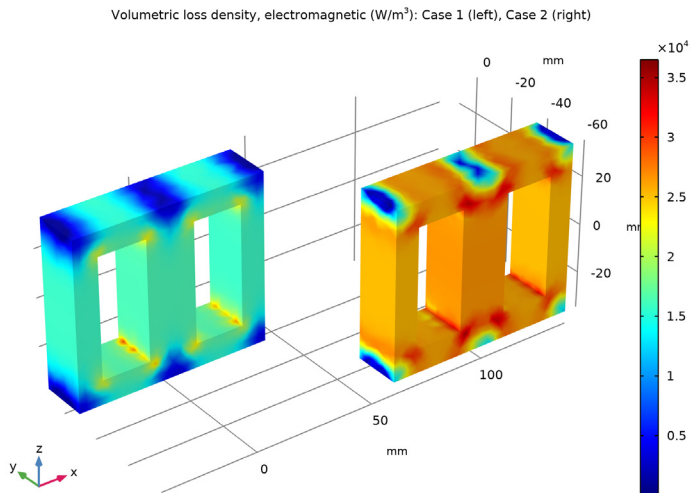

Figure 8: The iron loss power density in the magnetic core of the transformer.

Notes About the COMSOL Implementation

Use the Magnetic Fields interface to model the magnetic fields of the transformer. Model the primary and secondary windings with Coil features. Connect the primary and secondary windings to an external circuit with the AC voltage source and resistors using an Electrical Circuit interface. Add a Coil Geometry Analysis study step to calculate the current in the coils. Perform a Time Dependent study to determine the voltage and currents in both the primary and secondary windings. Add the Loss Calculation subfeatures in the Windings and Core and perform a Time to Frequency Losses study to compute the corresponding losses.

Application Library path: ACDC_Module/Other_Industrial_Applications/
ecore_transformer



Modeling Instructions

From the **File** menu, choose **New**.

NEW

In the **New** window, click  **Model Wizard**.

MODEL WIZARD

- 1 In the **Model Wizard** window, click  **3D**.
- 2 In the **Select Physics** tree, select **AC/DC>Electromagnetic Fields>Magnetic Fields (mf)**.
- 3 Click **Add**.
- 4 In the **Select Physics** tree, select **AC/DC>Electrical Circuit (cir)**.
- 5 Click **Add**.
- 6 Click  **Study**.
- 7 In the **Select Study** tree, select **Preset Studies for Some Physics Interfaces>Coil Geometry Analysis**.
- 8 Click  **Done**.

GLOBAL DEFINITIONS

Define all the required parameters.

Parameters 1

- 1 In the **Model Builder** window, under **Global Definitions** click **Parameters 1**.
- 2 In the **Settings** window for **Parameters**, locate the **Parameters** section.
- 3 In the table, enter the following settings:

Name	Expression	Value	Description
Rp	100[ohm]	100 Ω	Primary side resistance
Ns	300	300	Number of turns in secondary winding
nu	50[Hz]	50 Hz	Frequency of supply voltage

DEFINITIONS

Variables, Case 1

- 1 In the **Model Builder** window, under **Component 1 (comp1)** right-click **Definitions** and choose **Variables**.
- 2 In the **Settings** window for **Variables**, type **Variables, Case 1** in the **Label** text field. Set the variables for the first case study.
- 3 Locate the **Variables** section. In the table, enter the following settings:

Name	Expression	Unit	Description
Rs	10[kohm]	Ω	Secondary side resistance
Np	300		Number of turns in primary winding
Vac	25[V]	V	Supply voltage

Variables, Case 2

- 1 Right-click **Variables, Case 1** and choose **Duplicate**.
- 2 In the **Settings** window for **Variables**, type **Variables, Case 2** in the **Label** text field. Set the variables for the second case study. Note that you need to disable one of the two sets of variables before solving.
- 3 Locate the **Variables** section. In the table, enter the following settings:

Name	Expression	Unit	Description
Rs	100[ohm]	Ω	Secondary side resistance
Np	3e5		Number of turns in primary winding
Vac	25[kV]	V	Supply voltage

GEOMETRY I

Insert the geometry sequence from the `ecore_transformer_geom_sequence.mph` file.

- 1 In the **Geometry** toolbar, click  **Insert Sequence**.
- 2 Browse to the model's Application Libraries folder and double-click the file `ecore_transformer_geom_sequence.mph`.

Extrude I (extI)

Define the selections for the core and the windings and create a selection for the core domain.

- 1 In the **Model Builder** window, under **Component I (compI)>Geometry I** click **Extrude I (extI)**.
- 2 In the **Settings** window for **Extrude**, locate the **Selections of Resulting Entities** section.
- 3 Find the **Cumulative selection** subsection. Click **New**.
- 4 In the **New Cumulative Selection** dialog box, type Core in the **Name** text field.
- 5 Click **OK**.

Specify then a selection for the primary winding.

Primary Winding

- 1 In the **Geometry** toolbar, click  **Selections** and choose **Explicit Selection**.
- 2 In the **Settings** window for **Explicit Selection**, type Primary Winding in the **Label** text field.
- 3 On the object **fin**, select Domains 5, 6, 8, and 9 only.
- 4 Locate the **Resulting Selection** section. Find the **Cumulative selection** subsection. Click **New**.
- 5 In the **New Cumulative Selection** dialog box, type Windings in the **Name** text field.
- 6 Click **OK**.

Add a selection for the secondary winding.

Secondary Winding

- 1 In the **Geometry** toolbar, click  **Selections** and choose **Explicit Selection**.
- 2 On the object **fin**, select Domains 3, 4, 7, and 10 only.
- 3 In the **Settings** window for **Explicit Selection**, locate the **Resulting Selection** section.
- 4 Find the **Cumulative selection** subsection. From the **Contribute to list**, choose **Windings**.
- 5 In the **Label** text field, type Secondary Winding.

Form Union (fin)

- 1 In the **Geometry** toolbar, click  **Build All**.
- 2 Click the  **Zoom Extents** button in the **Graphics** toolbar.
Choose wireframe rendering to get a better view of the interior parts.
- 3 Click the  **Wireframe Rendering** button in the **Graphics** toolbar.

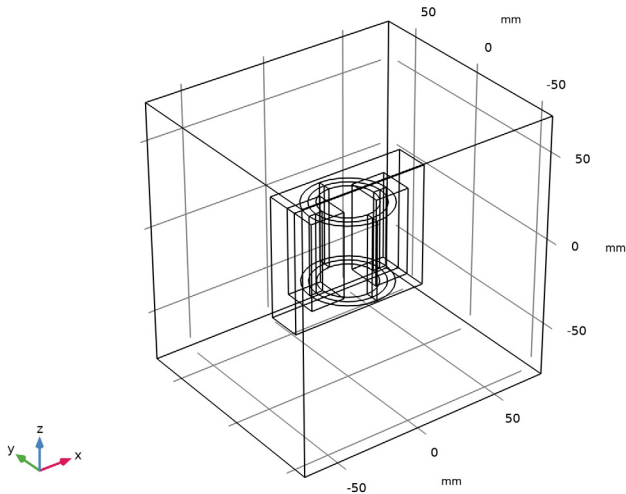

The geometry should look like the one in the figure above.

Now set up the physics for the magnetic fields. Start by hiding the outer boundaries to visualize the results only in the transformer core and windings.

DEFINITIONS

Hide for Physics I

- 1 In the **Model Builder** window, right-click **View 1** and choose **Hide for Physics**.
- 2 In the **Settings** window for **Hide for Physics**, locate the **Geometric Entity Selection** section.
- 3 From the **Geometric entity level** list, choose **Boundary**.
- 4 Select Boundaries 1–5 and 56 only.

MAGNETIC FIELDS (MF)

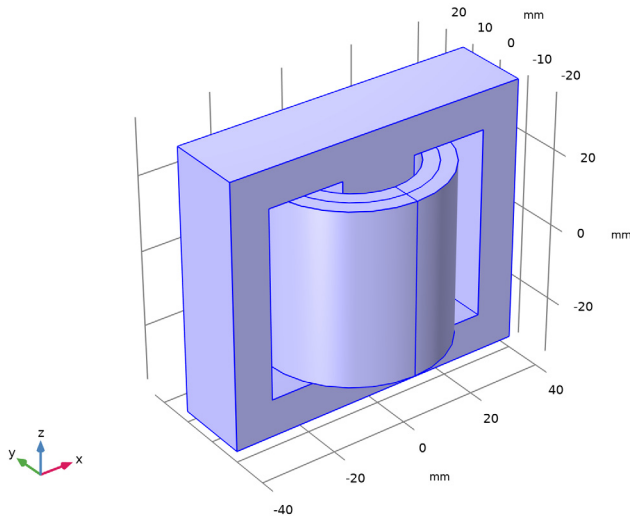

Choose linear curl elements for discretizing the magnetic vector potential. This will make the model computationally efficient. Typically, the default quadratic elements are recommended.

5 In the **Model Builder** window, under **Component 1 (comp1)** click **Magnetic Fields (mf)**.

6 In the **Settings** window for **Magnetic Fields**, click to expand the **Discretization** section.

7 From the **Magnetic vector potential** list, choose **Linear**.

Apply **Ampère's Law** in the core and the air domain.

Ampère's Law 2

1 In the **Physics** toolbar, click  **Domains** and choose **Ampère's Law**.

2 In the **Settings** window for **Ampère's Law**, locate the **Domain Selection** section.

3 From the **Selection** list, choose **Core**.

4 Locate the **Constitutive Relation B-H** section. From the **Magnetization model** list, choose **B-H curve**.

Loss Calculation 1

1 In the **Physics** toolbar, click  **Attributes** and choose **Loss Calculation**.

2 In the **Settings** window for **Loss Calculation**, locate the **Loss Model** section.

3 From the **Loss model** list, choose **Steinmetz**.

Add **Coil** features to model the primary and the secondary windings using the **Homogenized multiturn** conductor model.

Coil 1

- 1 In the **Physics** toolbar, click  **Domains** and choose **Coil**.
- 2 In the **Settings** window for **Coil**, locate the **Domain Selection** section.
- 3 From the **Selection** list, choose **Primary Winding**.
- 4 Locate the **Coil** section. From the **Conductor model** list, choose **Homogenized multiturn**.
- 5 From the **Coil type** list, choose **Numeric**.
- 6 Locate the **Homogenized Multiturn Conductor** section. In the N text field, type N_p .
- 7 Locate the **Coil** section. From the **Coil excitation** list, choose **Circuit (current)**.

Loss Calculation 1

In the **Physics** toolbar, click  **Attributes** and choose **Loss Calculation**.

Input 1

- 1 In the **Model Builder** window, expand the **Component 1 (comp1)>Magnetic Fields (mf)>Coil 1>Geometry Analysis 1** node, then click **Input 1**.
- 2 Select Boundary 35 only.

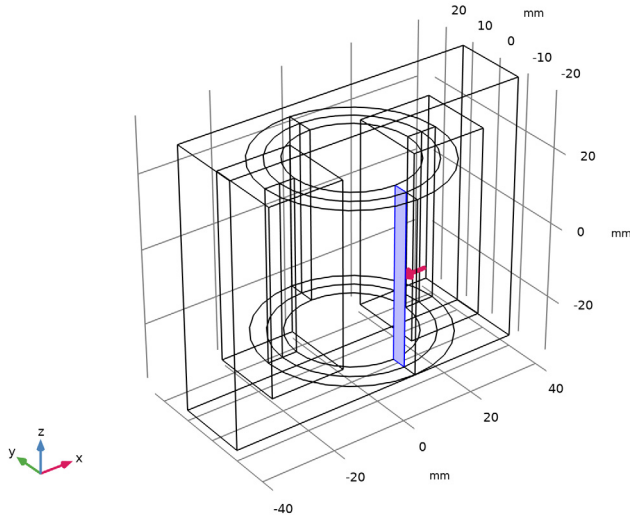

Coil 2

- 1 In the **Physics** toolbar, click  **Domains** and choose **Coil**.

- 2 In the **Settings** window for **Coil**, locate the **Domain Selection** section.
- 3 From the **Selection** list, choose **Secondary Winding**.
- 4 Locate the **Coil** section. From the **Conductor model** list, choose **Homogenized multiturn**.
- 5 From the **Coil type** list, choose **Numeric**.
- 6 Locate the **Homogenized Multiturn Conductor** section. In the N text field, type N_s .
- 7 Locate the **Coil** section. From the **Coil excitation** list, choose **Circuit (current)**.

Loss Calculation 1

In the **Physics** toolbar, click  **Attributes** and choose **Loss Calculation**.

Input 1

- 1 In the **Model Builder** window, expand the **Component 1 (comp1)>Magnetic Fields (mf)>Coil 2>Geometry Analysis 1** node, then click **Input 1**.
- 2 Select Boundary 31 only.

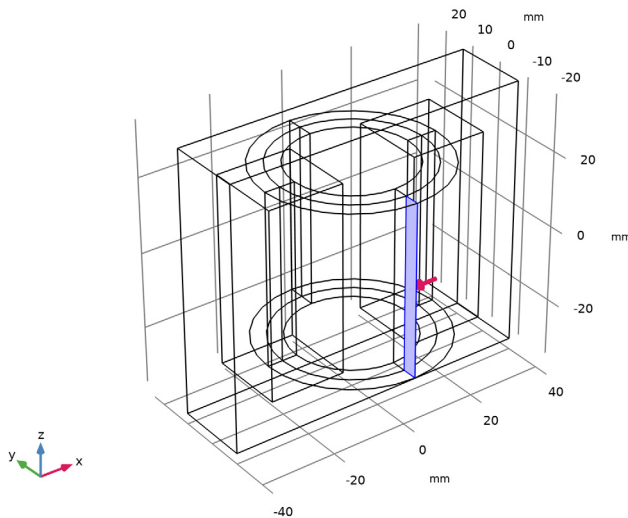

Gauge Fixing for A-field 1

- 1 In the **Physics** toolbar, click  **Domains** and choose **Gauge Fixing for A-field**.
- 2 In the **Settings** window for **Gauge Fixing for A-field**, locate the **Gauge Fixing for A-field** section.
- 3 From the **Equation form** list, choose **Stationary**.

Gauge fixing in its static form is applied on all domains in which the **Magnetic Fields** interface is active.

ELECTRICAL CIRCUIT (CIR)

Add the external circuit elements to the primary and the secondary side of the transformer as shown in [Figure 2](#).

1 In the **Model Builder** window, under **Component 1 (comp1)** click **Electrical Circuit (cir)**.

Voltage Source 1 (V1)

1 In the **Electrical Circuit** toolbar, click  **Voltage Source**.

2 In the **Settings** window for **Voltage Source**, locate the **Node Connections** section.

3 In the table, enter the following settings:

Label	Node names
p	1
n	0

4 Locate the **Device Parameters** section. From the **Source type** list, choose **Sine source**.

5 In the v_{src} text field, type Vac.

6 In the f text field, type nu.

External I vs. U 1 (IvsU1)

1 In the **Electrical Circuit** toolbar, click  **External I vs. U**.

2 In the **Settings** window for **External I vs. U**, locate the **Node Connections** section.

3 In the table, enter the following settings:

Label	Node names
p	2
n	1

4 Locate the **External Device** section. From the V list, choose **Coil voltage (mf/coil 1)**.

Resistor 1 (R1)

1 In the **Electrical Circuit** toolbar, click  **Resistor**.

2 In the **Settings** window for **Resistor**, locate the **Node Connections** section.

3 In the table, enter the following settings:

Label	Node names
p	0
n	2

4 Locate the **Device Parameters** section. In the R text field, type Rp.

External I vs. U 2 (IvsU2)

1 In the **Electrical Circuit** toolbar, click  **External I vs. U**.

2 In the **Settings** window for **External I vs. U**, locate the **Node Connections** section.

3 In the table, enter the following settings:

Label	Node names
p	3
n	0

4 Locate the **External Device** section. From the V list, choose **Coil voltage (mf/coil2)**.

Resistor 2 (R2)

1 In the **Electrical Circuit** toolbar, click  **Resistor**.

2 In the **Settings** window for **Resistor**, locate the **Node Connections** section.

3 In the table, enter the following settings:

Label	Node names
p	0
n	3

4 Locate the **Device Parameters** section. In the R text field, type Rs.

Assign materials for the model. Begin by specifying air for all domains.

ADD MATERIAL

1 In the **Home** toolbar, click  **Add Material** to open the **Add Material** window.

2 Go to the **Add Material** window.

3 In the tree, select **Built-in>Air**.

4 Click **Add to Component** in the window toolbar.

MATERIALS

Air (mat1)

Next, assign the soft iron (without losses) material for the core.

ADD MATERIAL

- 1 Go to the **Add Material** window.
- 2 In the tree, select **AC/DC>Soft Iron (Without Losses)**.
- 3 Click **Add to Component** in the window toolbar.
- 4 In the **Home** toolbar, click  **Add Material** to close the **Add Material** window.

MATERIALS

Soft Iron (Without Losses) (mat2)

- 1 In the **Settings** window for **Material**, locate the **Geometric Entity Selection** section.
- 2 From the **Selection** list, choose **Core**.
Optionally, use the following steps to visualize the nonlinear B-H curve of the soft iron. Note that the extrapolation of the B-H curve is set to 'constant' only for visualization purpose. When solving the model, the extrapolation has to be changed to 'linear'.
- 3 In the **Model Builder** window, expand the **Soft Iron (Without Losses) (mat2)** node.

Interpolation 1 (BH, BH_inv, BH_prim)

- 1 In the **Model Builder** window, expand the **Component 1 (comp1)>Materials>Soft Iron (Without Losses) (mat2)>B-H Curve (BHCurve)** node, then click **Interpolation 1 (BH, BH_inv, BH_prim)**.
- 2 In the **Settings** window for **Interpolation**, locate the **Interpolation and Extrapolation** section.
- 3 From the **Extrapolation** list, choose **Constant**.

4 Click  **Plot**.

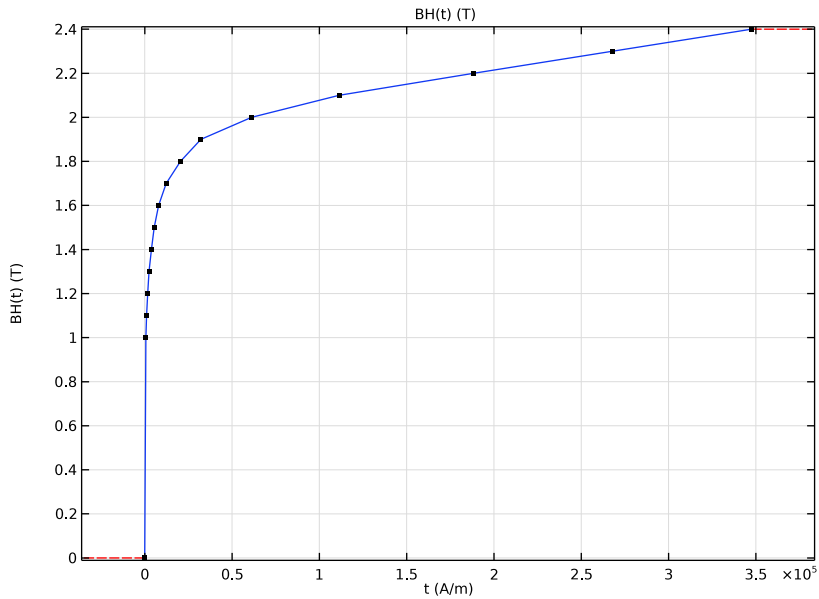

5 From the **Extrapolation** list, choose **Linear**.

MESH 1

- 1 In the **Model Builder** window, under **Component 1 (comp1)** click **Mesh 1**.
- 2 In the **Settings** window for **Mesh**, locate the **Physics-Controlled Mesh** section.
- 3 From the **Element size** list, choose **Extra coarse**.

Free Tetrahedral 1

- 1 In the **Mesh** toolbar, click  **Free Tetrahedral**.
- 2 In the **Settings** window for **Free Tetrahedral**, locate the **Domain Selection** section.
- 3 From the **Geometric entity level** list, choose **Entire geometry**.

Size 1

- 1 Right-click **Free Tetrahedral 1** and choose **Size**.
- 2 In the **Settings** window for **Size**, locate the **Geometric Entity Selection** section.
- 3 From the **Geometric entity level** list, choose **Domain**.
- 4 Click  **Paste Selection**.
- 5 In the **Paste Selection** dialog box, type 2-10 in the **Selection** text field.

- 6 Click **OK**.
- 7 In the **Settings** window for **Size**, locate the **Element Size** section.
- 8 Click the **Custom** button.
- 9 Locate the **Element Size Parameters** section. Select the **Maximum element size** check box.
- 10 In the associated text field, type 8.
- 11 Click  **Build All**.

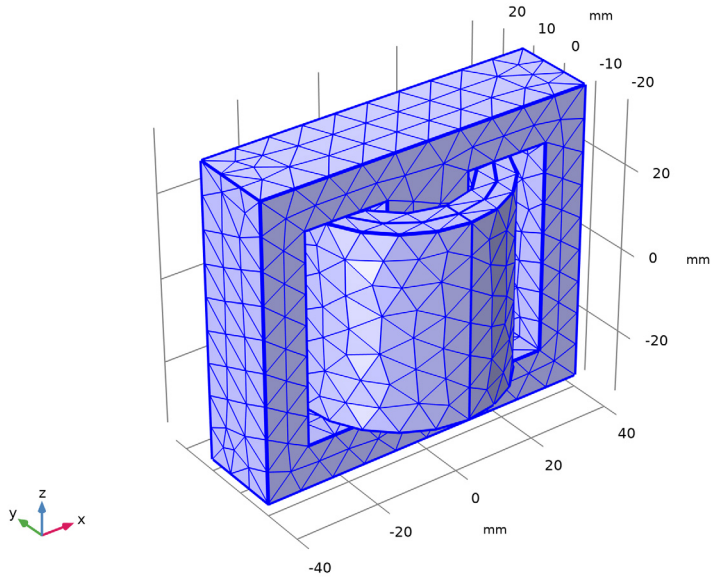

After adjusting the hiding settings by clicking on the **View Unhidden Only** button, the mesh should look like that shown in the figure above. A coarse mesh is used here to solve the model quickly. For real simulations, you are recommended to use a finer mesh.

STUDY 1

Step 1: Coil Geometry Analysis



- 1 In the **Model Builder** window, under **Study 1** click **Step 1: Coil Geometry Analysis**.
- 2 In the **Settings** window for **Coil Geometry Analysis**, locate the **Physics and Variables Selection** section.
- 3 Select the **Modify model configuration for study step** check box.
- 4 In the **Physics and variables selection** tree, select **Component 1 (comp1)>Definitions>Variables, Case 2**.

- 5 Click  **Disable**.
- 6 In the **Model Builder** window, click **Study 1**.
- 7 In the **Settings** window for **Study**, locate the **Study Settings** section.
- 8 Clear the **Generate default plots** check box.

Solve the **Coil Geometry Analysis** study step for the analysis of the geometry of the primary and the secondary windings which will be necessary for the next transient studies.

- 9 In the **Home** toolbar, click  **Compute**.

ADD STUDY

- 1 In the **Home** toolbar, click  **Add Study** to open the **Add Study** window.
- 2 Go to the **Add Study** window.
- 3 Find the **Studies** subsection. In the **Select Study** tree, select **General Studies> Time Dependent**.
- 4 Click **Add Study** in the window toolbar.
- 5 In the **Home** toolbar, click  **Add Study** to close the **Add Study** window.

STUDY 2, CASE 1

- 1 In the **Model Builder** window, right-click **Study 2** and choose **Rename**.
- 2 In the **Rename Study** dialog box, type **Study 2, Case 1** in the **New label** text field.
- 3 Click **OK**.
- 4 In the **Settings** window for **Study**, locate the **Study Settings** section.
- 5 Clear the **Generate default plots** check box.



Step 1: Time Dependent

Solve the problem in time domain from 0 to 50 milliseconds.

- 1 In the **Model Builder** window, under **Study 2, Case 1** click **Step 1: Time Dependent**.
- 2 In the **Settings** window for **Time Dependent**, locate the **Study Settings** section.
- 3 In the **Output times** text field, type range (0,5e-4,0.05).
- 4 Locate the **Physics and Variables Selection** section. Select the **Modify model configuration for study step** check box.
- 5 In the **Physics and variables selection** tree, select **Component 1 (comp1)>Definitions> Variables, Case 2**.
- 6 Click  **Disable**.

- 7 Click to expand the **Values of Dependent Variables** section. Follow the steps given below to tune the solver. Such tuning is typically necessary in order to successfully use a realistic nonlinear B-H curve in a large time-dependent model. As the equations are nonlinear the solver needs to be robust enough to handle such nonlinearities. It is worth noticing that as the **Magnetic Fields** problem does contains only **Ampere's Law** nodes where conductivity is null (air and laminated iron) and **Coil** describing **Homogenized multiturn** conductors, it is computationally more efficient to enforce **Gauge Fixing to Stationary**. This allows to have zero conductivity in regions and it is making the transient solution easier to handle from the solver.
- 8 Find the **Values of variables not solved for** subsection. From the **Settings** list, choose **User controlled**.
- 9 From the **Method** list, choose **Solution**.
- 10 From the **Study** list, choose **Study 1, Coil Geometry Analysis**.

Solution 2 (sol2)

- 1 In the **Study** toolbar, click  **Show Default Solver**.
- 2 In the **Model Builder** window, expand the **Solution 2 (sol2)** node, then click **Dependent Variables 1**.
- 3 In the **Settings** window for **Dependent Variables**, locate the **Scaling** section.
- 4 From the **Method** list, choose **None**.
- 5 In the **Model Builder** window, click **Time-Dependent Solver 1**.
- 6 In the **Settings** window for **Time-Dependent Solver**, click to expand the **Time Stepping** section.
- 7 In the **Model Builder** window, click **Fully Coupled 1**.
- 8 In the **Settings** window for **Fully Coupled**, click to expand the **Method and Termination** section.
- 9 From the **Jacobian update** list, choose **On every iteration**.
- 10 In the **Maximum number of iterations** text field, type 25.
- 11 In the **Study** toolbar, click  **Compute**.

RESULTS

In the **Model Builder** window, expand the **Results** node.

Study 2, Case 1/Solution 2 (sol2)

Use the following steps to generate a surface plot of the magnetic flux density norm on core and coils and an arrow plot of the current in the windings. The figure should look



like that shown in [Figure 3](#). Since the current magnitude in the secondary is much smaller than in the primary, two separate arrow plots (with different scales) will be used.

- 1 In the **Model Builder** window, expand the **Results>Datasets** node, then click **Study 2, Case 1/Solution 2 (sol2)**.

Selection

- 1 In the **Results** toolbar, click  **Attributes** and choose **Selection**.
- 2 In the **Settings** window for **Selection**, locate the **Geometric Entity Selection** section.
- 3 From the **Geometric entity level** list, choose **Domain**.
- 4 Select Domains 2–10 only.

Magnetic Flux Density and Current

- 1 In the **Results** toolbar, click  **3D Plot Group**.
- 2 Right-click **3D Plot Group 1** and choose **Rename**.
- 3 In the **Rename 3D Plot Group** dialog box, type Magnetic Flux Density and Current in the **New label** text field.
- 4 Click **OK**.
- 5 In the **Settings** window for **3D Plot Group**, locate the **Data** section.
- 6 From the **Dataset** list, choose **Study 2, Case 1/Solution 2 (sol2)**.
- 7 Click the  **Zoom Extents** button in the **Graphics** toolbar.

Volume 1

Right-click **Magnetic Flux Density and Current** and choose **Volume**.

Selection 1

- 1 In the **Model Builder** window, right-click **Volume 1** and choose **Selection**.
- 2 Select Domains 2, 4, 6–8, and 10 only.
- 3 In the **Magnetic Flux Density and Current** toolbar, click  **Plot**.

Arrow Volume 1

- 1 In the **Model Builder** window, right-click **Magnetic Flux Density and Current** and choose **Arrow Volume**.
- 2 In the **Settings** window for **Arrow Volume**, click **Replace Expression** in the upper-right corner of the **Expression** section. From the menu, choose **Component 1 (comp1)>Magnetic Fields>Currents and charge>mf.jx,mf.jy,mf.jz - Current density**.
- 3 Locate the **Arrow Positioning** section. Find the **x grid points** subsection. In the **Points** text field, type 10.

- 4 Find the **y grid points** subsection. In the **Points** text field, type 10.
- 5 Find the **z grid points** subsection. In the **Points** text field, type 5.
- 6 Locate the **Coloring and Style** section. From the **Color** list, choose **Blue**.
- 7 Select the **Scale factor** check box.
- 8 In the associated text field, type $2.5e-5$.



Selection 1

- 1 Right-click **Arrow Volume 1** and choose **Selection**.
- 2 In the **Settings** window for **Selection**, locate the **Selection** section.
- 3 From the **Selection** list, choose **Primary Winding**.

Arrow Volume 2

- 1 In the **Model Builder** window, under **Results>Magnetic Flux Density and Current** right-click **Arrow Volume 1** and choose **Duplicate**.
- 2 In the **Settings** window for **Arrow Volume**, locate the **Coloring and Style** section.
- 3 From the **Color** list, choose **Black**.
- 4 In the **Scale factor** text field, type 0.0025.

Selection 1

- 1 In the **Model Builder** window, expand the **Arrow Volume 2** node, then click **Selection 1**.
- 2 In the **Settings** window for **Selection**, locate the **Selection** section.
- 3 From the **Selection** list, choose **Secondary Winding**.
- 4 Click the  **Zoom Extents** button in the **Graphics** toolbar.
- 5 In the **Magnetic Flux Density and Current** toolbar, click  **Plot**.

The plot is as shown in [Figure 3](#).

Follow the steps below to reproduce the magnetic flux density norm plot as shown in [Figure 4](#).

Magnetic Flux Density in the Core

- 1 In the **Home** toolbar, click  **Add Plot Group** and choose **3D Plot Group**.
- 2 Right-click **3D Plot Group 2** and choose **Rename**.
- 3 In the **Rename 3D Plot Group** dialog box, type Magnetic Flux Density in the Core in the **New label** text field.
- 4 Click **OK**.
- 5 In the **Settings** window for **3D Plot Group**, locate the **Data** section.

- 6 From the **Dataset** list, choose **Study 2, Case 1/Solution 2 (sol2)**.
- 7 Click to expand the **Selection** section. From the **Geometric entity level** list, choose **Domain**.
- 8 From the **Selection** list, choose **Core**.

Slice 1

- 1 Right-click **Magnetic Flux Density in the Core** and choose **Slice**.
- 2 In the **Settings** window for **Slice**, locate the **Plane Data** section.
- 3 From the **Plane** list, choose **zx-planes**.
- 4 In the **Planes** text field, type 1.

Arrow Volume 1

- 1 In the **Model Builder** window, right-click **Magnetic Flux Density in the Core** and choose **Arrow Volume**.
- 2 In the **Settings** window for **Arrow Volume**, locate the **Arrow Positioning** section.
- 3 Find the **x grid points** subsection. In the **Points** text field, type 10.
- 4 Find the **y grid points** subsection. In the **Points** text field, type 1.
- 5 Find the **z grid points** subsection. In the **Points** text field, type 10.
- 6 Locate the **Coloring and Style** section. From the **Arrow type** list, choose **Cone**.
- 7 Select the **Scale factor** check box.
- 8 In the associated text field, type 30.
- 9 From the **Color** list, choose **Black**.

Magnetic Flux Density in the Core

- 1 In the **Model Builder** window, click **Magnetic Flux Density in the Core**.
- 2 In the **Magnetic Flux Density in the Core** toolbar, click  **Plot**.

The plot is as shown in [Figure 4](#).

Next, plot the induced voltage in the primary winding.

Induced Voltage in the Windings, Case 1

- 1 In the **Home** toolbar, click  **Add Plot Group** and choose **ID Plot Group**.
- 2 In the **Settings** window for **ID Plot Group**, locate the **Data** section.
- 3 From the **Dataset** list, choose **Study 2, Case 1/Solution 2 (sol2)**.
- 4 Right-click **ID Plot Group 3** and choose **Rename**.

- 5 In the **Rename ID Plot Group** dialog box, type **Induced Voltage** in the **Windings, Case 1** in the **New label** text field.
- 6 Click **OK**.
- 7 In the **Settings** window for **ID Plot Group**, locate the **Plot Settings** section.
- 8 Select the **Two y-axes** check box.
- 9 Select the **x-axis label** check box.
- 10 In the associated text field, type **Time (seconds)**.
- 11 Select the **y-axis label** check box.
- 12 In the associated text field, type **Induced voltage in primary (V)**.
- 13 Select the **Secondary y-axis label** check box.
- 14 In the associated text field, type **Induced voltage in secondary (V)**.

Global 1

- 1 Right-click **Induced Voltage in the Windings, Case 1** and choose **Global**.
- 2 In the **Settings** window for **Global**, click **Replace Expression** in the upper-right corner of the **y-Axis Data** section. From the menu, choose **Component 1 (comp 1)>Magnetic Fields>Coil parameters>mf.VCoil_1 - Coil voltage - V**.
- 3 Locate the **y-Axis Data** section. In the table, enter the following settings:

Expression	Unit	Description
mf.VCoil_1	V	Induced voltage in the primary winding

- 4 Click to expand the **Coloring and Style** section. Find the **Line markers** subsection. From the **Marker** list, choose **Cycle**.
- 5 Click to expand the **Legends** section. From the **Legends** list, choose **Manual**.
- 6 In the table, enter the following settings:

Legends
VCoil_1

Global 2

- 1 Right-click **Global 1** and choose **Duplicate**.
- 2 In the **Settings** window for **Global**, locate the **y-Axis Data** section.
- 3 In the table, enter the following settings:

Expression	Unit	Description
mf.VCoil_2	V	Induced voltage in the secondary winding

- 4 Locate the **y-Axis** section. Select the **Plot on secondary y-axis** check box.
- 5 Locate the **Legends** section. In the table, enter the following settings:

Legends

VCoil_2

- 6 In the **Induced Voltage in the Windings, Case 1** toolbar, click  **Plot**.

The plot is as shown in [Figure 5](#).

Plot the current in the windings and compare them.

Current in the Windings, Case 1

- 1 In the **Home** toolbar, click  **Add Plot Group** and choose **ID Plot Group**.
- 2 In the **Settings** window for **ID Plot Group**, locate the **Data** section.
- 3 From the **Dataset** list, choose **Study 2, Case 1/Solution 2 (sol2)**.
- 4 Right-click **ID Plot Group 4** and choose **Rename**.
- 5 In the **Rename ID Plot Group** dialog box, type **Current** in the **Windings, Case 1** in the **New label** text field.
- 6 Click **OK**.
- 7 In the **Settings** window for **ID Plot Group**, locate the **Plot Settings** section.
- 8 Select the **Two y-axes** check box.
- 9 Select the **x-axis label** check box.
- 10 In the associated text field, type **Time (seconds)**.
- 11 Select the **y-axis label** check box.
- 12 In the associated text field, type **Current** in the primary winding (A).
- 13 Select the **Secondary y-axis label** check box.
- 14 In the associated text field, type **Current** in the secondary winding (V).

Global 1

- 1 Right-click **Current in the Windings, Case 1** and choose **Global**.
- 2 In the **Settings** window for **Global**, click **Replace Expression** in the upper-right corner of the **y-Axis Data** section. From the menu, choose **Component 1 (comp1)>Magnetic Fields>Coil parameters>mf.ICoil_1 - Coil current - A**.

3 Locate the **y-Axis Data** section. In the table, enter the following settings:

Expression	Unit	Description
mf.ICoil_1	A	Current in the primary winding

4 Locate the **Coloring and Style** section. Find the **Line markers** subsection. From the **Marker** list, choose **Cycle**.

5 Locate the **Legends** section. From the **Legends** list, choose **Manual**.

6 In the table, enter the following settings:

Legends
ICoil_1

Global 2

1 Right-click **Global 1** and choose **Duplicate**.

2 In the **Settings** window for **Global**, locate the **y-Axis Data** section.

3 In the table, enter the following settings:

Expression	Unit	Description
mf.ICoil_2	A	Current in the secondary winding

4 Locate the **y-Axis** section. Select the **Plot on secondary y-axis** check box.

5 Locate the **Legends** section. In the table, enter the following settings:

Legends
ICoil_2

6 In the **Current in the Windings, Case 1** toolbar, click  **Plot**.

The plot is as shown in [Figure 6](#).

ADD STUDY

1 In the **Home** toolbar, click  **Add Study** to open the **Add Study** window.

2 Go to the **Add Study** window.

3 Find the **Studies** subsection. In the **Select Study** tree, select **General Studies> Time Dependent**.

4 Click **Add Study** in the window toolbar.

5 In the **Home** toolbar, click  **Add Study** to close the **Add Study** window.

STUDY 3, CASE 2

- 1 In the **Model Builder** window, right-click **Study 3** and choose **Rename**.
- 2 In the **Rename Study** dialog box, type **Study 3, Case 2** in the **New label** text field.
- 3 Click **OK**.
- 4 In the **Settings** window for **Study**, locate the **Study Settings** section.
- 5 Clear the **Generate default plots** check box.

Step 1: Time Dependent

- 1 In the **Model Builder** window, under **Study 3, Case 2** click **Step 1: Time Dependent**.
- 2 In the **Settings** window for **Time Dependent**, locate the **Study Settings** section.
- 3 In the **Output times** text field, type range $(0, 5e-4, 0.05)$.
- 4 Locate the **Physics and Variables Selection** section. Select the **Modify model configuration for study step** check box.
- 5 In the **Physics and variables selection** tree, select **Component 1 (comp1)>Definitions>Variables, Case 1**.
- 6 Click  **Disable**.
- 7 Locate the **Values of Dependent Variables** section. Find the **Values of variables not solved for** subsection. From the **Settings** list, choose **User controlled**.
- 8 From the **Method** list, choose **Solution**.
- 9 From the **Study** list, choose **Study 1, Coil Geometry Analysis**.

Solution 3 (sol3)

- 1 In the **Study** toolbar, click  **Show Default Solver**.
- 2 In the **Model Builder** window, expand the **Solution 3 (sol3)** node.
- 3 In the **Model Builder** window, expand the **Study 3, Case 2>Solver Configurations>Solution 3 (sol3)>Time-Dependent Solver 1** node, then click **Study 3, Case 2>Solver Configurations>Solution 3 (sol3)>Dependent Variables 1**.
- 4 In the **Settings** window for **Dependent Variables**, locate the **Scaling** section.
- 5 From the **Method** list, choose **None**.
- 6 In the **Model Builder** window, click **Time-Dependent Solver 1**.
- 7 In the **Settings** window for **Time-Dependent Solver**, locate the **Time Stepping** section.
- 8 From the **Maximum step constraint** list, choose **Constant**.
- 9 In the **Maximum step** text field, type $2.5e-4$.

- 10 From the **Steps taken by solver** list, choose **Strict**.
- 11 In the **Model Builder** window, click **Fully Coupled 1**.
- 12 In the **Settings** window for **Fully Coupled**, locate the **Method and Termination** section.
- 13 From the **Jacobian update** list, choose **On every iteration**.
- 14 In the **Maximum number of iterations** text field, type 25.
- 15 In the **Model Builder** window, click **Direct**.
- 16 In the **Settings** window for **Direct**, locate the **General** section.
- 17 From the **Solver** list, choose **PARDISO**.
- 18 In the **Study** toolbar, click  **Compute**.

RESULTS

Induced Voltage in the Windings, Case 2

- 1 In the **Model Builder** window, right-click **Induced Voltage in the Windings, Case 1** and choose **Duplicate**.
- 2 Right-click **Induced Voltage in the Windings, Case 1.1** and choose **Rename**.
- 3 In the **Rename ID Plot Group** dialog box, type **Induced Voltage in the Windings, Case 2** in the **New label** text field.
- 4 Click **OK**.
- 5 In the **Settings** window for **ID Plot Group**, locate the **Data** section.
- 6 From the **Dataset** list, choose **Study 3, Case 2/Solution 3 (sol3)**.
- 7 In the **Induced Voltage in the Windings, Case 2** toolbar, click  **Plot**.
The plot is as shown in [Figure 7](#).
Next, compute the losses.

ADD STUDY

- 1 In the **Home** toolbar, click  **Add Study** to open the **Add Study** window.
- 2 Go to the **Add Study** window.
- 3 Find the **Studies** subsection. In the **Select Study** tree, select **Preset Studies for Some Physics Interfaces>Time to Frequency Losses**.
- 4 Click **Add Study** in the window toolbar.
- 5 Click **Add Study** in the window toolbar.

LOSS CALCULATION, CASE 1



- 1 In the **Settings** window for **Study**, locate the **Study Settings** section.
- 2 Clear the **Generate default plots** check box.
- 3 Right-click **Study 4** and choose **Rename**.
- 4 In the **Rename Study** dialog box, type Loss Calculation, Case 1 in the **New label** text field.
- 5 Click **OK**.

LOSS CALCULATION, CASE 2

- 1 In the **Settings** window for **Study**, locate the **Study Settings** section.
- 2 Clear the **Generate default plots** check box.
- 3 Right-click **Study 5** and choose **Rename**.
- 4 In the **Rename Study** dialog box, type Loss Calculation, Case 2 in the **New label** text field.
- 5 Click **OK**.

LOSS CALCULATION, CASE 1



Step 1: Time to Frequency Losses

- 1 In the **Settings** window for **Time to Frequency Losses**, locate the **Study Settings** section.
- 2 From the **Input study** list, choose **Study 2, Case 1, Time Dependent**.
- 3 Locate the **Physics and Variables Selection** section. Select the **Modify model configuration for study step** check box.
- 4 In the **Physics and variables selection** tree, select **Component 1 (comp1)>Definitions>Variables, Case 2**.
- 5 Click  **Disable**.
- 6 In the **Home** toolbar, click  **Compute**.

LOSS CALCULATION, CASE 2

Step 1: Time to Frequency Losses

- 1 In the **Model Builder** window, under **Loss Calculation, Case 2** click **Step 1: Time to Frequency Losses**.
- 2 In the **Settings** window for **Time to Frequency Losses**, locate the **Study Settings** section.
- 3 From the **Input study** list, choose **Study 3, Case 2, Time Dependent**.

- 4 Locate the **Physics and Variables Selection** section. Select the **Modify model configuration for study step** check box.
- 5 In the **Physics and variables selection** tree, select **Component 1 (comp1)>Definitions>Variables, Case 1**.
- 6 Click  **Disable**.
- 7 In the **Home** toolbar, click  **Compute**.

RESULTS

Cycle Averaged Losses in the Core

- 1 In the **Home** toolbar, click  **Add Plot Group** and choose **3D Plot Group**.
- 2 Right-click **3D Plot Group 6** and choose **Rename**.
- 3 In the **Rename 3D Plot Group** dialog box, type *Cycle Averaged Losses in the Core* in the **New label** text field.
- 4 Click **OK**.
- 5 In the **Settings** window for **3D Plot Group**, locate the **Plot Settings** section.
- 6 Clear the **Plot dataset edges** check box.
- 7 Click to expand the **Title** section. From the **Title type** list, choose **Manual**.
- 8 In the **Title** text area, type *Volumetric loss density, electromagnetic (W/m³): Case 1 (left), Case 2 (right)*.

Volume 1

- 1 Right-click **Cycle Averaged Losses in the Core** and choose **Volume**.
- 2 In the **Settings** window for **Volume**, locate the **Data** section.
- 3 From the **Dataset** list, choose **Loss Calculation, Case 1/Solution 4 (sol4)**.
- 4 Locate the **Expression** section. In the **Expression** text field, type *mf.Qh*.

Selection 1

- 1 Right-click **Volume 1** and choose **Selection**.
- 2 In the **Settings** window for **Selection**, locate the **Selection** section.
- 3 From the **Selection** list, choose **Core**.

Volume 2

- 1 In the **Model Builder** window, under **Results>Cycle Averaged Losses in the Core** right-click **Volume 1** and choose **Duplicate**.
- 2 In the **Settings** window for **Volume**, locate the **Data** section.

- 3 From the **Dataset** list, choose **Loss Calculation, Case 2/Solution 6 (sol6)**.
- 4 Locate the **Coloring and Style** section. Clear the **Color legend** check box.
- 5 Click to expand the **Inherit Style** section. From the **Plot** list, choose **Volume I**.

Deformation I

- 1 Right-click **Volume 2** and choose **Deformation**.
- 2 In the **Settings** window for **Deformation**, locate the **Expression** section.
- 3 In the **x component** text field, type 1.
- 4 In the **y component** text field, type -0.5.
- 5 Locate the **Scale** section. Select the **Scale factor** check box.
- 6 In the associated text field, type 100.

Cycle Averaged Losses in the Core

- 1 In the **Model Builder** window, click **Cycle Averaged Losses in the Core**.
- 2 In the **Cycle Averaged Losses in the Core** toolbar, click  **Plot**.



The plot is as shown in [Figure 8](#).

Volume Integration I

- 1 In the **Results** toolbar, click  **More Derived Values** and choose **Integration> Volume Integration**.
- 2 In the **Settings** window for **Volume Integration**, locate the **Data** section.
- 3 From the **Dataset** list, choose **Loss Calculation, Case 1/Solution 4 (sol4)**.
- 4 Locate the **Selection** section. From the **Selection** list, choose **Core**.
- 5 Locate the **Expressions** section. In the table, enter the following settings:

Expression	Unit	Description
mf.Qh	W	Volumetric loss density, electromagnetic

Compute the total iron loss power in the core.

- 6 Click  **Evaluate**.
- 7 Locate the **Data** section. From the **Dataset** list, choose **Loss Calculation, Case 2/Solution 6 (sol6)**.
- 8 Click  **Evaluate**.