

Rotordynamics Module

User's Guide

Rotordynamics Module User's Guide

© 1998–2019 COMSOL

Protected by patents listed on www.comsol.com/patents, and U.S. Patents 7,519,518; 7,596,474; 7,623,991; 8,457,932; 8,954,302; 9,098,106; 9,146,652; 9,323,503; 9,372,673; 9,454,625; and 10,019,544. Patents pending.

This Documentation and the Programs described herein are furnished under the COMSOL Software License Agreement (www.comsol.com/comsol-license-agreement) and may be used or copied only under the terms of the license agreement.

COMSOL, the COMSOL logo, COMSOL Multiphysics, COMSOL Desktop, COMSOL Compiler, COMSOL Server, and LiveLink are either registered trademarks or trademarks of COMSOL AB. All other trademarks are the property of their respective owners, and COMSOL AB and its subsidiaries and products are not affiliated with, endorsed by, sponsored by, or supported by those trademark owners. For a list of such trademark owners, see www.comsol.com/trademarks.

Version: COMSOL 5.5

Contact Information

Visit the Contact COMSOL page at www.comsol.com/contact to submit general inquiries, contact Technical Support, or search for an address and phone number. You can also visit the Worldwide Sales Offices page at www.comsol.com/contact/offices for address and contact information.

If you need to contact Support, an online request form is located at the COMSOL Access page at www.comsol.com/support/case. Other useful links include:

- Support Center: www.comsol.com/support
- Product Download: www.comsol.com/product-download
- Product Updates: www.comsol.com/support/updates
- COMSOL Blog: www.comsol.com/blogs
- Discussion Forum: www.comsol.com/community
- Events: www.comsol.com/events
- COMSOL Video Gallery: www.comsol.com/video
- Support Knowledge Base: www.comsol.com/support/knowledgebase

Part number: CM024601

C o n t e n t s

Chapter 1: Introduction

About the Rotordynamics Module	12
What Can the Rotordynamics Module Do?	12
Where Do I Access the Documentation and Application Libraries?	13
Overview of the User's Guide	15

Chapter 2: Rotordynamics Modeling

Selecting Physics Interfaces	18
Solid Rotor	18
Beam Rotor.	18
Hydrodynamic Bearing.	19
Study Types	20
Stationary or Dynamic Analysis	20
Stationary Study	20
Eigenfrequency Study	21
Frequency Domain Study.	22
Time Domain Study.	22
Transient with FFT Study.	23
Modeling Bearings	24
Journal Bearing	24
Thrust Bearing.	25
Multi-Spool Bearing.	26
Modeling Foundations	27
Fixed Foundation.	27
Moving Foundation	27
Flexible Foundation	27

Squeeze Film Damper	27
Specifying the Rotor Axis	29
Support Locations	29
Edge	29
Gears	30
Gear Pairs	31
Forward and Backward Whirl	32
Campbell Plot	34
Limitations of the Campbell Plot	34
Determination of the Critical Speed	35
Comparing Beam Rotor and Solid Rotor	35
References	36

Chapter 3: Rotordynamics Theory

Solid Rotor Theory	39
Frames and Coordinate Systems	40
Fixed and Corotating Frames	40
Displacement, Velocity, and Acceleration	42
Rotor Axis	45
Support Locations	45
Edge	45
Change Rotor Speed	46
Geared Rotor System	46

Formulation of Equilibrium Equations	47
Transformation of Some Quantities	47
Equation Implementation	48
Damping	50
Rayleigh Damping	50
Rigid Domain	51
Fixed Axial Rotation	53
Weak Constraint	54
Loads	55
Distributed Loads	55
Gravity	56
Bearings and Foundations	57
Journal Bearing	57
Thrust Bearing	63
Radial Roller Bearing	67
Fixed Foundation	84
Moving Foundation	85
Flexible Foundation	85
Squeeze Film Damper	86
References	87
Multi-Spool Bearing	88
Displacement and Rotations in Solid Rotor	88
Intershaft Connection	89
Rotor Coupling	91
Spline Coupling	91
Torsional Coupling	91
User Defined	92
Misalignment	95
Journal and Thrust Bearings	95
Radial Roller Bearing	96

Rotor Coupling	97
Multi-Spool Bearing	97
Identification of Whirl	98
References	102
Added Mass	103
Energy Quantities	104
Elastic Energy	104
Kinetic Energy	104
Gear Theory	106
Spur Gear Theory	106
Helical Gear Theory	108
Bevel Gear Theory	109
Gear Pair Theory	111
Theory for Gear Pairs	111
Theory for Gear Elasticity	119
Theory for Transmission Error	125
Theory for Backlash.	126
Theory for Gear Friction.	128

Chapter 4: Solid Rotor

The Solid Rotor Interface	132
Domain, Boundary, and Pair Nodes for the Solid Rotor Interface . . .	134
Initial Values	135
Linear Elastic Material	136
Rotor Axis	138
First Support	139
Second Support	139
Axis.	140
Fixed Axial Rotation	140

Change Rotor Speed	140
Journal Bearing	141
Thrust Bearing	143
Radial Roller Bearing	145
Flexible Foundation	147
Moving Foundation	148
Squeeze Film Damper	148
Misalignment	149
Multi-Spool Bearing	150
Rotor Coupling	151
Body Load	152
Gravity	154
Boundary Load	154
Applied Torque	156
Added Mass	156
Spur Gear	157
Helical Gear	160
Bevel Gear	160
Gear Axis	161
Initial Values (Gear)	162
Gear Pair	163
Gear Elasticity	165
Transmission Error	166
Backlash	168
Friction (Gear)	169

Chapter 5: Beam Rotor

Beam Rotor Theory	172
Displacement, Velocity, and Acceleration	173
Implementation	175
Disk	177
The Beam Rotor Interface	178
Domain, Boundary, and Pair Nodes for the Beam Rotor Interface	180
Initial Values	181
Rotor Cross Section	182
Fixed Axial Rotation	183
Disk.	184
Journal Bearing	185
Thrust Bearing.	187
Radial Roller Bearing	188
Squeeze Film Damper	190
Rotor Coupling	191
Edge Load	192
Point Load	193

Chapter 6: Hydrodynamic Bearing

Hydrodynamic Bearing Theory	196
Reynolds Equation	197
Thin-Film Flow in Bearings	197
The Reynolds Equation	198
Flow Models	201
The Modified Reynolds Equation — Gas Flows	208
Boundary Conditions	209
Cavitation	210

Dissipation	211
Misalignment	213
References for the Thin-Film Flow Interfaces	214
Bearing Dynamic Coefficients Calculation	217
Perturbation Equations	218
Boundary Conditions	219
Stiffness and Damping Coefficients	219
Initial Film Thickness in Journal Bearing	220
Plain.	220
Elliptic	221
Split Halves	222
Multilobe	223
Tilted Pad	223
User Defined	228
Floating Ring Bearing	229
Equations of Motion for the Ring.	231
Connection Between Inner and Outer Film.	232
Initial Film Thickness in Thrust Bearings	233
Tilted Pad Bearing	233
Tapered Land Bearing	238
The Hydrodynamic Bearing Interface	244
Domain, Boundary, and Pair Nodes for the Hydrodynamic Bearing	
Interface.	246
Hydrodynamic Journal Bearing.	247
Floating Ring Bearing	253
Inner Film Properties	255
Outer Film Properties	256
Inner-Outer Film Connection	256
Hydrodynamic Thrust Bearing	257
Squeeze Film Damper	262
Bearing Orientation.	263
Border.	264
Initial Values	265

Inlet.	266
Outlet.	266
Wall	267
Symmetry	267

Chapter 7: Multiphysics Interfaces and Couplings

The Solid Rotor with Hydrodynamic Bearing Interface	270
Solid Rotor Bearing Coupling	271
The Beam Rotor with Hydrodynamic Bearing Interface	273
Beam Rotor Bearing Coupling	274
Solid-Bearing Coupling	276
Theory for the Solid Rotor Bearing Coupling	278
Theory for the Beam Rotor Bearing Coupling	282
Theory for Solid-Bearing Coupling	284
Effect of Deformation	287

Introduction

This guide describes the Rotordynamics Module, an optional add-on package for the COMSOL Multiphysics® simulation software. The module is designed to perform the static and dynamic analysis of a rotor of a rotating machinery mounted with various stationary and moving components.

This chapter introduces you to the capabilities of the Rotordynamics Module and includes a summary of the physics interfaces and where you can find documentation and model examples. The last section provides a brief overview with links to the chapters in this guide.

In this chapter:

- [About the Rotordynamics Module](#)
- [Overview of the User's Guide](#)

About the Rotordynamics Module

In this section:

- [What Can the Rotordynamics Module Do?](#)
- [Where Do I Access the Documentation and Application Libraries?](#)

What Can the Rotordynamics Module Do?

The Rotordynamics Module, which requires the Structural Mechanics Module, can be used to model the rotor of a rotating machinery mounted with various stationary and rotating components. Using this module, you can obtain the dynamic response of a rotor when subjected to external loads and thus the operational behavior of the rotor for different angular speeds. You can also produce a stability map of the rotor against different angular speeds. Some major application areas are automotive, aerospace, power generation, electrical machines, and home appliances.

There are five physics interfaces in the Rotordynamics Module:

- The *Solid Rotor* interface for modeling the rotor as a 3D object.
- The *Beam Rotor* interface for abstract modeling of the rotor as lines.
- The *Hydrodynamic Bearing* interface for modeling the flow in the lubricant film in a bearing.
- The *Solid Rotor with Hydrodynamic Bearing* interface for combined modeling of the rotor and bearing and the interactions between them. The solid mechanics formulation of the rotor is used.
- The *Beam Rotor with Hydrodynamic Bearing* interface for combined modeling of the rotor and bearing and the interactions between them. The beam formulation of the rotor is used.

All physics interfaces in the Rotordynamics Module appear on the Model Wizard's **Select Physics** page under **Structural Mechanics>Rotordynamics**.



In the *COMSOL Multiphysics Reference Manual*:

- [Studies and Solvers](#)
- [The Physics Interfaces](#)
- For a list of all the core physics interfaces included with a COMSOL Multiphysics software license, see the [Physics Interface Guide](#).

Where Do I Access the Documentation and Application Libraries?

A number of internet resources have more information about COMSOL, including licensing and technical information. The electronic documentation, topic-based (or context-based) help, and the application libraries are all accessed through the COMSOL Desktop.



If you are reading the documentation as a PDF file on your computer, the [blue links](#) do not work to open an application or content referenced in a different guide. However, if you are using the Help system in COMSOL Multiphysics, these links work to open other modules, application examples, and documentation sets.

CONTACTING COMSOL BY EMAIL

For general product information, contact COMSOL at info@comsol.com.

COMSOL ACCESS AND TECHNICAL SUPPORT

To receive technical support from COMSOL for the COMSOL products, please contact your local COMSOL representative or send your questions to support@comsol.com. An automatic notification and a case number are sent to you by email. You can also access technical support, software updates, license information, and other resources by registering for a COMSOL Access account.

COMSOL ONLINE RESOURCES

COMSOL website	www.comsol.com
Contact COMSOL	www.comsol.com/contact

COMSOL Access	www.comsol.com/access
Support Center	www.comsol.com/support
Product Download	www.comsol.com/product-download
Product Updates	www.comsol.com/support/updates
COMSOL Blog	www.comsol.com/blogs
Discussion Forum	www.comsol.com/community
Events	www.comsol.com/events
COMSOL Video Gallery	www.comsol.com/video
Support Knowledge Base	www.comsol.com/support/knowledgebase

Overview of the User's Guide

The *Rotordynamics Module User's Guide* gets you started with modeling rotordynamics applications using COMSOL Multiphysics. The information in this guide is specific to this module. Instructions on how to use COMSOL Multiphysics in general are included in the *COMSOL Multiphysics Reference Manual*.



As detailed in the section [Where Do I Access the Documentation and Application Libraries?](#), this information can also be searched from the COMSOL Multiphysics software **Help** menu.

TABLE OF CONTENTS AND INDEX

To help you navigate this guide, see the [Contents](#) and [Index](#) sections.

MODELING WITH ROTORDYNAMICS MODULE

The [Rotordynamics Modeling](#) chapter gives you insight into how to approach modeling various rotordynamics problems. The content covers subjects such as [Selecting Physics Interfaces](#), [Study Types](#), [Modeling Bearings](#), [Modeling Foundations](#), [Specifying the Rotor Axis](#), [Gears](#), [Gear Pairs](#), [Forward and Backward Whirl](#), and [Campbell Plot](#).

ROTORDYNAMICS THEORY

The [Rotordynamics Theory](#) chapter outlines the theory for the various interfaces present in the Rotordynamics Module. The [Rotor Axis](#) section describes the considerations in obtaining the rotor axis and how it affects the frame acceleration forces on rotor. This chapter also covers topics such as [Frames and Coordinate Systems](#); [Displacement, Velocity, and Acceleration](#); [Formulation of Equilibrium Equations](#); [Damping, Bearings and Foundations](#), [Rotor Coupling](#), [Misalignment](#), [Identification of Whirl](#), [Gear Theory](#), [Gear Pair Theory](#); and [Energy Quantities](#).

THE SOLID ROTOR INTERFACE

The [Solid Rotor](#) chapter describes [The Solid Rotor Interface](#) and all the available feature nodes. Nodes which are unique to the Solid Rotor interface are described in detail. The rest of the feature nodes are described in the *Structural Mechanics Module User's Guide*.

THE BEAM ROTOR INTERFACE

The [Beam Rotor](#) chapter describes the Beam Rotor interface, which uses Timoshenko beam theory for modeling the rotor. This chapter also describes the underlying theory for the physics interface and the available feature nodes in [The Beam Rotor Interface](#). The Bearings and Foundation nodes are described in the Solid Rotor chapter. The rest of the feature nodes are described in the *Structural Mechanics Module User's Guide*.

THE HYDRODYNAMIC BEARING INTERFACE

The [Hydrodynamic Bearing](#) chapter describes the Hydrodynamic Bearing interface and all the available feature nodes. The Hydrodynamic Journal Bearing feature and Bearing Types are therein described in detail.

MULTIPHYSICS INTERFACES AND COUPLINGS

The [Multiphysics Interfaces and Couplings](#) chapter describes two multiphysics interfaces found under the Rotordynamics branch when adding a physics interface:

- [The Solid Rotor with Hydrodynamic Bearing Interface](#) combines a Solid Rotor interface with a Hydrodynamic Bearing interface. The coupling appears on the boundary level, where the pressure from the Hydrodynamic Bearing interface acts as a mechanical load for the Solid Rotor interface, causing motion and structural deformation of the rotor. The motion and deformation of the Solid Rotor affect the lubricant film thickness, hence altering the pressure of lubricant film.
- [The Beam Rotor with Hydrodynamic Bearing Interface](#) combines a Beam Rotor interface with a Hydrodynamic Bearing interface. The coupling appears on the boundary level, where the pressure from the Hydrodynamic Bearing interface acts as a mechanical load for the Beam Rotor interface, causing motion and structural deformation of the rotor. The motion and deformation of the Beam Rotor affect the lubricant film thickness, hence altering the pressure of lubricant film.

Rotordynamics Modeling

The goal of this chapter is to give you insight into how to approach the modeling of rotordynamics problems and different types of analyses.

In this chapter:

- [Selecting Physics Interfaces](#)
- [Study Types](#)
- [Modeling Bearings](#)
- [Modeling Foundations](#)
- [Specifying the Rotor Axis](#)
- [Gears](#)
- [Gear Pairs](#)
- [Forward and Backward Whirl](#)
- [Campbell Plot](#)

Selecting Physics Interfaces

The Rotordynamics Module contains tools for modeling rotors and bearings. For modeling the rotor, there are two physics interfaces: the Solid Rotor interface and the Beam Rotor interface. The basic physics interfaces in the Rotordynamics Module are:

- **Solid Rotor** — For modeling the rotor as a 3D object
- **Beam Rotor** — For the abstract modeling of the rotor as a line object with bending stiffness
- **Hydrodynamic Bearing** — For modeling hydrodynamic sliding bearings with very small oil film thickness

Solid Rotor

The Solid Rotor interface offers the most general approach for modeling a rotor based on a continuum description. Solid elements are used to define the rotor assembly, and the rotor is represented by its three-dimensional geometry. This interface automatically accounts for the frame acceleration forces due to rotation of the rotor about its axis; hence the physical rotation is not needed to model the rotor. Also, the effect of spin softening and stress stiffening can be captured automatically using solid elements.

With the Solid Rotor interface, as opposed to a conventional rotordynamic analysis approach, the rotor vibration cannot be split into axial, bending, and torsional components. Furthermore, rotordynamic analysis using solid elements is very computationally expensive, particularly in a case where you are interested in predicting the response of the rotor at various angular speeds. Therefore, use this interface only when you are interested in the details of the deformation and stresses in the rotor.

Beam Rotor

The Beam Rotor interface is an abstract model of the actual rotor assembly, where only the span in the axial direction is modeled explicitly on an edge. The cross-sectional information of the rotor is specified in terms of properties such as area and moments of inertia. This approach neglects the cross-sectional deformation of the rotor. Beam elements, based on Timoshenko theory where shear deformations are taken into account, are used to model the rotor assembly. This also makes it possible to accurately model rather thick rotors using beam elements. In this interface, the vibration response

can be split into axial, bending, and torsional components. As it is customary in a rotordynamics study to analyze the response of the rotor at different angular speeds, it is very efficient, in terms of computational cost, to use beam elements to model the rotor system without losing its basic characteristics.

Hydrodynamic Bearing

The Hydrodynamic Bearing interface can be used for modeling the sliding bearings where oil between the journal and bushing acts as a lubricant. Using this interface, you can obtain the pressure distribution in the oil film by solving the Reynolds equation. This interface provides built-in models for plain, elliptic, split-halves, multilobe, and tilted-pad bearings. If the bearing does not fall into any of these categories, there is also an option to specify the initial oil film thickness in the bearing

The Hydrodynamic Bearing interface can be used either independently to study bearing characteristics or together with the Solid Rotor or Beam Rotor interfaces to study the response of the full rotor assembly through a multiphysics coupling.

Study Types

In this section, you will find information about when and how to apply the study types that are available for rotordynamics problems:

- [Stationary Study](#)
- [Eigenfrequency Study](#)
- [Frequency Domain Study](#)
- [Time Domain Study](#)
- [Transient with FFT Study](#)

Stationary or Dynamic Analysis

When using the Rotordynamics Module, you must adopt a view where the concepts of what is static and what is dynamic deviate somewhat from the common conceptions.

In a general structural mechanics setting, different forms of dynamic analysis are used when inertial forces cannot be ignored. As the rotordynamics interfaces are formulated in a corotating frame, some of the inertial effects are already taken into account as static loads. Thus, a rotor that spins under conditions that are stationary when viewed by a corotating observer does not require a dynamic analysis.

On the other hand, a load that is fixed in the spatial frame, like gravity, will have a harmonic variation when seen from the corotating perspective, and it provides a dynamic excitation.

Stationary Study

A rotordynamics problem can be considered stationary if the following two criteria are fulfilled:

- Loads in the corotating frame do not change their magnitude and direction significantly, for example, in an inertial load due to mass eccentricity. Note that a load that appears stationary in a space-fixed frame has a very strong time dependence in the corotating frame and vice versa.
- There is no explicit time dependence in the material model of the rotor. Viscoelasticity and creep do have such time dependencies.

In some cases, there is a variation in the load, even though the solution for each value of the load can be considered to be stationary. A typical case is that the load values are independent, and you just want to compute a number of different load cases. For example, you may want to find the stresses and magnitude of the lateral displacement of the rotor for different eccentric masses.

Note that a stationary problem is solvable only if the structure is sufficiently constrained. There must not be any possible rigid body modes, thus no stress-free deformation states are allowed. If the model is underconstrained, you may encounter problems like singular or ill-conditioned system matrices.

Eigenfrequency Study

An eigenfrequency study solves for the natural frequencies and the corresponding mode shapes. It is also possible to compute the eigenfrequencies for a problem that is not fully constrained. This is sometimes referred to as free-free modes. In practice, the natural frequencies of the rigid body modes are not computed as exactly zero, but can appear as small numbers, which can even be negative or complex. If the rigid-body modes are present in the model, then it is important to use a nonzero value in the **Search for eigenfrequencies around** text field in the settings for the Eigenfrequency study step. The value should reflect the order of the magnitude of the first important nonzero eigenfrequency.



In the *COMSOL Multiphysics Reference Manual*:

- [Eigenvalue Solver](#)
- [Studies and Solvers](#)
- [Derived Values, Evaluation Groups, and Tables](#)

In the *Structural Mechanics Module User's Guide*:

- [Eigenfrequency Analysis](#)
-

In rotordynamics, an eigenfrequency analysis is the most commonly used study type. It is used to determine the critical speed of the rotor. This type of analysis can be performed in the following scenarios:

- To determine the stable operating ranges and critical speeds of the rotor. In this case, an eigenfrequency analysis is repeated multiple times by performing a sweep over the rotor's angular speed to determine the resonance conditions of the rotor.

An angular speed at which the rotor experiences a resonance is called a critical speed. A very important result of such an analysis is a plot of the variation of the natural frequency of the rotor versus the angular speed of the rotor, called a *Campbell diagram*.

- To check if the assembly operates safely for a given operational speed. Sometimes, the operational angular velocity of a rotor is predetermined. In this case, the main interest lies in studying the behavior of the rotor at this given operational speed. You can then perform the eigenfrequency analysis at a single angular velocity to check that no eigenfrequencies are close to the operating speed.

Frequency Domain Study

If all loads are time harmonic when seen from the corotating frame, then a frequency domain study is an efficient method for computing the response of the rotor. In this study type, all quantities are represented by complex amplitudes, where the relation between the real and imaginary parts determines the phase.

In a rotordynamic analysis, the only meaningful analysis frequency in a frequency domain study is the one that corresponds to the angular speed of the rotor.



In the *COMSOL Multiphysics Reference Manual*:

- [Frequency Domain](#)
- [Studies and Solvers](#)

In the *Structural Mechanics Module User's Guide*:

- [Frequency Domain Analysis](#)
-

Time Domain Study

You will need to use a time-dependent study when analyzing truly transient events, or when loads or supports vary with the angle of rotation.

There are two general solvers for time-dependent problems in COMSOL Multiphysics:

- The *Generalized alpha* method, which is recommended for structural dynamics problems.
- The *BDF* method, which is recommended for first-order problems.

The Generalized alpha method is the default solver in the Rotordynamics Module due to the transient nature of this class of problems.



In the *COMSOL Multiphysics Reference Manual*:

- [Time-Dependent Solver](#)
- [Studies and Solvers](#)

In the *Structural Mechanics Module User's Guide*:

- [Time Domain Analysis](#)
-

Transient with FFT Study

In many cases, you can obtain a good overview of the response of the rotor by plotting the entire frequency spectrum of the time response at different angular speeds. Such a plot is called a *waterfall diagram*. The *Transient with FFT* study helps generate such data by performing the parametric sweep over the rotor angular speed. This study consists of a Time Dependent study step followed by a Time to Frequency FFT study step.

This type of study is very computationally expensive with a Solid Rotor interface, so this combination should only be used when the local deformation of the rotor plays a significant role in determining the overall dynamics of the rotor assembly.



In the *COMSOL Multiphysics Reference Manual*:

- [Time-Dependent Solver](#)
 - [Time to Frequency FFT](#)
 - [Studies and Solvers](#)
-

Modeling Bearings

Bearings are an integral part of a rotor assembly. In the rotordynamics interfaces, the rotor can only be supported by bearings. The response of the rotor system is sensitive to the bearing model that is used. Therefore, it is important to model the bearings accurately. Following are the commonly used bearings to restrict the motion of the rotor in different directions:

- [Journal Bearing](#)
- [Thrust Bearing](#)
- [Multi-Spool Bearing](#)

Journal Bearing

Journal bearings restrict the translational motion of the journal in the lateral direction. In addition, they also restrict the rotation of the journal about both the lateral axes due to the finite length of the journal. The modeling of journal bearings can be done at different levels of detail, as described below.

NO CLEARANCE BEARING

This type of bearing completely restricts the translational and rotational motion of the journal in the lateral direction. You can use this approximation when the bearings are very stiff, so that the motion of the journal in the bearing is small and does not significantly affect the overall response of the rotor.

PLAIN HYDRODYNAMIC BEARING

This bearing model works as a spring and damper system on the journal of the rotor. The dynamic stiffness and damping coefficients are obtained by Ocvirk's theory, which uses a short bearing approximation (See [Ref. 1](#)). Use this model when the bearing's dynamic stiffness and damping coefficients are unknown and you want to evaluate them as functions of the journal motion in the bearing. This method is a good approximation for modeling the effect of an oil wedge in plain hydrodynamic bearings.

BEARING STIFFNESS AND DAMPING COEFFICIENT

In a journal bearing model, the bearing operates as a spring and damper system on the journal of the rotor. The only difference from the plain hydrodynamic bearing is that in this case, the dynamic stiffness and damping coefficients are known *a priori* through

experiments or computer simulations. Both functional and tabular forms of these parameters are supported. For the tabular data, you need to use an interpolation function.

BEARING FORCES AND MOMENTS

In many cases, it is easier to evaluate the reaction of the bearing on the journal because reaction forces and moments due to bearing can be applied directly on the journal. Usually, forces and moments in the bearing are functions of the journal motion. Force and moment data obtained through experiments or simulation can also be used through interpolation functions in this model.

MULTIPHYSICS COUPLING

When it is necessary to capture effects of oil whirl and whip, a multiphysics coupling can be used to model the bearing. These phenomena are connected with the hydrodynamic instability of the bearing. In this case, the Solid Rotor or Beam Rotor interfaces can be coupled with the Hydrodynamic Bearing interface.

Thrust Bearing

Thrust bearings are primarily used to restrict the axial motion of the rotor. However, due to the finite cross-sectional area of the collar of these bearings, they also restrict the rotation about the lateral axes. Thrust bearings can be modeled at different levels of detail, as described below.

NO CLEARANCE BEARING

This model completely constrains the axial motion of the rotor and the rotation about both lateral axes. Use this model when the effect of the bearing on the dynamics of the rotor assembly is not significant.

BEARING STIFFNESS AND DAMPING COEFFICIENTS

In this case, the thrust bearing is modeled as a spring-damper system with one translational stiffness and damping coefficient along the axis of the rotor, and two rotational stiffnesses and corresponding damping coefficients about the lateral directions. These values are known either by performing experiments or computer simulations. Tabular data of these parameters as a function of the collar motion can be entered as interpolation functions.

BEARING FORCES AND MOMENTS

You can also directly describe bearing forces and moments as functions of the motion of the collar. If tabular data is available for these relations, you can use interpolation functions for entering the data.

MULTIPHYSICS COUPLING

When it is necessary to capture nonlinear effects in the bearing, a multiphysics coupling can be used. For this type of modeling, both the Solid Rotor and the Beam Rotor interfaces can be coupled with the Hydrodynamic Bearing interface.

Multi-Spool Bearing

Multi-Spool Bearings restrict the relative lateral motion between the two coaxial rotors running at same or different speeds. The model for these bearings is based on equivalent stiffness and damping coefficients for the relative lateral and relative tilt motion between the rotors. There is also an option to make the connections between the two rotors rigid. For a rigid connection, both the rotors move and/or tilt together without any relative motion. To make either the lateral displacement or tilting free between the rotors, you can use a zero value in the corresponding stiffness and damping fields.

Modeling Foundations

Bearing foundations are the structural components on which bearings rest. The foundations can be modeled as:

- [Fixed Foundation](#)
- [Moving Foundation](#)
- [Flexible Foundation](#)
- [Squeeze Film Damper](#)

Fixed Foundation

Use this type of foundation if the component on which the bearings rest is very rigid or their motion does not significantly affect the rotor response.

Moving Foundation

Sometimes, ground vibration is present in the area where rotating machinery is installed. If you have the ground vibration data, you can use this type of foundation to study the effect of the ground vibration on the response of the rotor assembly. A displacement solution from another study can also be used to specify the foundation motion.

Flexible Foundation

Use this type of foundation when an equivalent stiffness of the foundation is known. A flexible foundation can alter the critical speed of the rotor and can thus be a critical element in the rotor assembly. The effect of the foundation on the critical speed of the rotor can be captured by this model. The **Fixed** and **Moving** foundation models described above do not affect the critical speed of the rotor.

Squeeze Film Damper

Sometimes, to increase the overall damping in the rotating machinery, bearings are extended with squeeze film dampers. These components provide damping by squeezing of the lubricant film. You can use this option to approximately model the effect of squeeze film dampers on the overall dynamics of the rotor. In this model, the

damper is represented by its equivalent damping coefficients obtained by analytically solving the Reynolds equations for a short length approximation. This model also affects the critical speed of the rotor assembly.

Specifying the Rotor Axis

In the Beam Rotor interface, the modeled line geometry itself is considered to be the axis of the rotor. Therefore, there is no need to explicitly specify the axis of the rotor in this interface. Because of this assumption, you cannot model a nonstraight rotor in the Beam Rotor interface. Therefore, a geometry such as a crankshaft of an internal combustion engine is not straightforward to model in the Beam Rotor interface. A **Disk** node with an offset can be used to model the inertial effects and account for the eccentricity of the crankpin and balance masses from the rotor axis, assuming that both are rigid. A straight line can then be used to model the crankshaft.

In the Solid Rotor interface, the axis of the rotor cannot be determined automatically. You must specify the initial axis of the rotor through the **Rotor Axis** node. There are two methods you can use to specify the rotor axis:

- [Support Locations](#)
- [Edge](#)

Support Locations

When support locations are specified, a line joining these locations is considered to be the initial axis of rotation. This option can be useful for specifying the axis of the crankshaft-type rotor, where material points are absent at certain locations along the axis. For overhung rotors, where there is only one bearing support, you can choose two points near the support location to determine the rotor axis. However, an axis specified using an edge may be a better choice in this case.

Edge

In this method, a selected edge is considered to be the initial axis of the rotor. This method fails if there is no material point of the rotor along this line. A typical example is a crankshaft. In such a case, use support locations to prescribe the axis instead.

Gears

Gears are the mechanical components to transmit power from one shaft to another. They are also used to increase or decrease the output speed (transmitted torque) of the shafts. In general, on a single rotor, bending and torsional motion of the rotor are uncoupled. However, when gears are used to connect the rotors, bending and torsional motions of the rotor get coupled due to the gear meshing, thus significantly changing the response of the rotor. Three types of gears — spur, helical, and bevel — are provided in the Solid Rotor interface to support the modeling of systems of several rotors connected through gears.

A gear is defined as a rigid body. A finite stiffness for the gear mesh (or gear tooth) can be specified in the **Gear Pair** node while connecting to other gears. Similar to a rigid domain, the gears are a material model, which is mutually exclusive to all other material models. The only material property needed is the mass density.

Gears automatically get mounted on an adjacent flexible shaft. To attach a gear to a rigid shaft, the shaft itself can be selected in the **Gear** node.

The axis of the gear is the same as that of the rotor on which it is mounted.



For details about the theory of gears, see [Gear Theory](#).

Gear Pairs

The gear pair node connects two spur gears, helical gears, or bevel gears in such a way that at the contact point, they have no relative motion along the line of action. The remaining displacements and rotations of both the gears are independent of each other.

In the case of a line contact model, one additional constraint is added to restrict the relative rotation about a line joining the two gear centers. When friction is included for a gear pair, frictional forces in the plane perpendicular to the line of action are added on both of the gears.

The **Gear Pair** node is a global feature and takes two gears as input, thus providing the connection between the selected gears.

In the Rotordynamics Module, the rotor does not physically rotate. However, the mesh stiffness, which is periodic within a mesh cycle or within a full revolution of the gear, should account for the physical rotation of the gear. Therefore, the magnitude of the rotation of the gears is obtained by time integrating the respective angular velocities. This rotation is then added in the rotation that is due to torsional deformation of the shafts to specify the periodicity of the gear mesh stiffness.



For details about the theory of gear pairs, see [Gear Pair Theory](#).

Forward and Backward Whirl

For a symmetric rotor that is not rotating, all lateral vibration modes will appear in pairs with the same natural frequency. For the rotating system, the double natural frequencies will be split into two separate values, corresponding to forward and backward whirl. When vibrating at one of the natural frequencies, the corresponding mode shape will travel in an orbit due to the rotation of the rotor.

In a mode with forward whirl, the natural vibration mode travels in the same direction as the rotation of the rotor. For backward whirl, the situation is the opposite.

The orbit of the rotor actually consists of the summation of two rotating vectors: one is a forward circular motion and the other is a backward circular motion. When the forward amplitude is larger than the backward amplitude, the overall motion is forward. When the forward amplitude is smaller than the backward amplitude, the overall motion is backward. When both amplitudes are equal, the motion degenerates to a straight line.

When you have solved for the eigenfrequencies, you can plot a shape and directivity index variable, named `<interface>.isd` (for example, `rotbm.isd`). This variable has the range

$$-1 \leq i_{sd} \leq 1$$

A classification of the whirl can now be done using the following criteria:

- $i_{sd} = -1$: Backward circular planar motion
- $-1 < i_{sd} < 0$: Backward elliptical planar motion
- $i_{sd} = 0$: Straight line motion
- $0 < i_{sd} < 1$: Forward elliptical planar motion
- $i_{sd} = 1$: Forward circular planar motion

At points where the mode shape has a node (the lateral displacement is zero), the index cannot be determined, thus the value may be arbitrary.

Usually, the entire rotor has either forward or backward whirl. However, it is also possible that the complete rotor can have mixed whirling. In this case, the rotor can undergo forward and backward whirl simultaneously at different sections. Mixed whirling sometimes occurs in long, flexible rotors supported by fluid film bearings.



For details about the shape and directivity index variable, see [Identification of Whirl](#) in the theory section.

Campbell Plot

For an eigenfrequency analysis, a **Campbell Plot** is generated by default by both the Solid Rotor and Beam Rotor interfaces.

Since the equations in the Beam Rotor interface are formulated in a fixed reference frame, the **Campbell Plot** shows the eigenfrequencies in the fixed reference frame.

The equations in the Solid Rotor interface are however formulated in a corotating reference frame. Therefore, the frequencies computed by this interface can be considered as frequencies of the vibration observed from the corotating frame. The frequencies in the fixed frame and the corotating frame are related to each other by a very simple relation. For a forward whirl mode, an eigenfrequency in the corotating frame can be converted to an eigenfrequency in the fixed frame by adding the angular speed of the rotor. Similarly, an eigenfrequency in a backward whirl mode can be converted to fixed frame by subtracting the angular speed of the rotor.



For details about the identification of the whirl modes, see [Identification of Whirl](#) in the theory section.

Refer to the [Forward and Backward Whirl](#) section for the different variables provided in the interface to identify the whirl.

In the Solid Rotor interface, a **Campbell Plot** is generated in both corotating and fixed frame by default.

When you have solved for the eigenfrequencies, you can also evaluate forward and backward natural frequency variables, named `<interface>.omegaf` and `<interface>.omegab` (for example, `rotbm.omegaf`) in the fixed frame.

Limitations of the Campbell Plot

If there are multiple rotors present in the model, or if the rotor is very long, whirl modes can be mixed. In such rotor systems it is difficult to tell if the whirl mode is forward or backward. Therefore, the transformation of the eigenfrequencies from the corotating to the fixed frame as explained above fails. The Campbell plot may not show a correct result in this case. If you encounter such a case it, is better to plot only `<interface>.omega` in the Campbell plot. This variable should be interpreted in the respective frame the interfaces are modeled.

A Campbell plot only makes sense if there is a parametric sweep over the rotor angular speed. For a single rotor angular speed there is only one point on the abscissa. If your interest is only to look at the natural frequencies of the rotor for a given angular speed, you can ignore the default **Campbell Plot** or delete it from the model.

Determination of the Critical Speed

The critical speed of the rotor can be obtained by looking at the intersection of the Campbell plot with $\omega=\Omega$ curve in the fixed frame. If the plot is generated in the corotating frame, the intersection of the backward whirl eigenfrequency curve with $\omega=2\Omega$ curve is the backward whirl mode critical speed. Similarly, the intersection of the forward whirl eigenfrequency curve with the abscissa is the forward whirl mode critical speed. Generally, in the corotating frame, the backward whirl eigenfrequency curves increase with the rotor speed whereas the forward whirl mode curves decrease.

Comparing Beam Rotor and Solid Rotor

A comparison of Campbell plots must be done from a same frame of reference. Therefore, a Campbell plot obtained from the Beam Rotor interface should be compared with a Campbell plot in the fixed frame from the Solid Rotor interface. Because frame acceleration forces are modeled explicitly in the Solid Rotor interface, stress stiffening effects due to centrifugal forces are important to obtain the correct natural frequency. This can be done by setting up a stationary analysis to obtain the prestress in the structure caused by centrifugal forces, followed by an eigenfrequency analysis with the prestressed state as a linearization point. This effect is very important for cases where an object with a large moment of inertia on the rotor is tilted significantly in the mode shape.

References

1. W. J. Chen, and E.J. Gunter, *Introduction to Dynamics of Rotor-Bearing Systems*, Trafford Publishing, 2007.

Rotordynamics Theory

This chapter introduces you to the theory that is specific for the features in the Rotordynamics Module.

In this chapter:

- Solid Rotor Theory
- Frames and Coordinate Systems
- Displacement, Velocity, and Acceleration
- Rotor Axis
- Change Rotor Speed
- Formulation of Equilibrium Equations
- Damping
- Rigid Domain
- Fixed Axial Rotation
- Loads
- Bearings and Foundations
- Multi-Spool Bearing
- Rotor Coupling

- Misalignment
- Identification of Whirl
- Added Mass
- Energy Quantities
- Gear Theory
- Gear Pair Theory

Solid Rotor Theory

In the following, the theory for the Solid Rotor interface is described. To a large extent, this section also covers the theory for the Beam Rotor interface. Theory specific to the Beam Rotor interface and the Hydrodynamic Bearing interface is described in the corresponding chapters.



- [Beam Rotor Theory](#)
 - [Hydrodynamic Bearing Theory](#)
-

Frames and Coordinate Systems

Fixed and Corotating Frames

Consider a space-fixed frame O and a body-fixed rotating frame O^* as shown in Figure 3-1.

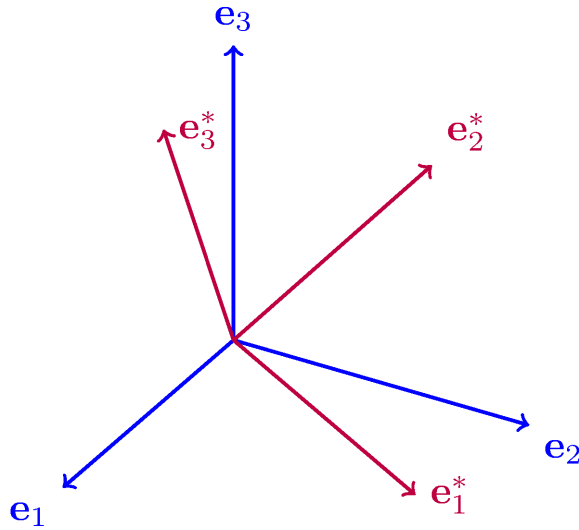

Figure 3-1: Canonical basis in different frames.

The origins of both frames coincide for all times t . The canonical basis vector triads for both frames are $\{\mathbf{e}_1, \mathbf{e}_2, \mathbf{e}_3\}$ and $\{\mathbf{e}_1^*, \mathbf{e}_2^*, \mathbf{e}_3^*\}$, respectively. Any vector \mathbf{v} in a basis can be expressed as

$$\mathbf{v} = (\mathbf{v} \cdot \mathbf{e}_i) \mathbf{e}_i = v_i \mathbf{e}_i$$

Therefore, basis vector triads in frame O^* can be expressed in terms of basis vectors in O as

$$\mathbf{e}_i^* = (\mathbf{e}_i^* \cdot \mathbf{e}_j) \mathbf{e}_j = R_{ij} \mathbf{e}_j$$

where the transformation matrix components are given by $R_{ij} = \mathbf{e}_i^* \cdot \mathbf{e}_j$. A component of a vector \mathbf{v} as observed from the frame O^* can be written in terms of the components observed in O as

$$v_i^* = \mathbf{v} \cdot \mathbf{e}_i^* = \mathbf{v} \cdot (R_{ij}\mathbf{e}_j) = R_{ij}v_j$$

Two frames will be considered: one is spatially fixed with its origin at \mathbf{x}_s and the other one is the body-fixed rotating frame with its origin at \mathbf{x}_r . Points expressed in the body-fixed coordinates are distinguished from those represented in spatial coordinates by an asterisk (*) symbol. This means that if \mathbf{x} is a point in the spatial coordinate system, then \mathbf{x}^* is the same point in the body-fixed coordinate system. Therefore, we can directly conclude that $\mathbf{x}_s = \mathbf{0}$ and $\mathbf{x}_r^* = \mathbf{0}$. However, \mathbf{x}_s^* and \mathbf{x}_r need not be zero. The relation between a space-fixed coordinate \mathbf{x} and body-fixed coordinate \mathbf{x}^* can be expressed as

$$\mathbf{x} = R^T(\mathbf{x}^* - \mathbf{x}_s^*) = R^T\mathbf{x}^* + \mathbf{x}_r$$

The inverse relation is

$$\mathbf{x}^* = R(\mathbf{x} - \mathbf{x}_r) = R\mathbf{x} + \mathbf{x}_s^*$$

From the above relations, it is clear that

$$\begin{aligned}\mathbf{x}_r &= -R^T\mathbf{x}_s^* \\ \mathbf{x}_s^* &= -R\mathbf{x}_r\end{aligned}$$

In the *Structural Mechanics User's Guide*, see also



- [Tensor Notation](#)
 - [Material and Spatial Coordinates](#)
 - [Coordinate Systems](#)
-

Displacement, Velocity, and Acceleration

This section aims at defining the displacement, velocity, and acceleration of a point on the rotor in a suitable frame of reference. To begin with, there are two different frames, namely, space fixed and corotating, in which the deformation of a rotor can be observed. In the Rotordynamics Module, modeling of the rotor is done in a corotating system, so that there is no need to physically rotate it. Rather, the effect of the rotation is accounted for as frame acceleration forces in the momentum balance equation. Therefore, the motion is described in terms of deformation observed in the corotating frame. Let \mathbf{X} be the material position of a particle on the rotor and \mathbf{u}_r be the displacement of that point due to the deformation in the corotating frame. In the following, a subscript 'r' is used to denote quantities observed in the corotating frame. Let \mathbf{X}_{bp} be the base point on the axis of the rotor in the space-fixed frame, which defines the origin of the corotating frame. Then, the position of the material point \mathbf{X} in the corotating frame is given by

$$\mathbf{X}_r = \mathbf{X} - \mathbf{X}_{bp}$$

By using the frame transformation rule, the position vector of the particle at point \mathbf{X} after the deformation (denoted χ), can be expressed in the space-fixed frame by

$$\chi(\mathbf{X}, t) = \mathbf{X}_{bp} + R(\mathbf{X}_r + \mathbf{u}_r) = \mathbf{X}_{bp} + R(\mathbf{X} + \mathbf{u}_r - \mathbf{X}_{bp}) \quad (3-1)$$

Here, R is the rotation matrix that maps the components in the rotated directions to those in the fixed directions and is defined as

$$R = \cos\theta \mathbf{I} + \frac{\sin\theta}{\theta} (\boldsymbol{\theta} \times \mathbf{I}) + \frac{(1 - \cos\theta)}{\theta^2} (\boldsymbol{\theta} \otimes \boldsymbol{\theta})$$

with θ being the magnitude of the rotation vector $\boldsymbol{\theta}$. \mathbf{I} is the identity matrix, and \otimes denotes a dyadic product.

The total displacement of a point on the rotor including the effect of rotation in the fixed frame can be expressed as

$$\mathbf{u} = \chi(\mathbf{X}, t) - \mathbf{X} = R\mathbf{u}_r + (R - \mathbf{I})(\mathbf{X} - \mathbf{X}_{bp}) \quad (3-2)$$

This expression for the displacement also accounts for the rotation. If the rotor is not flexible, then the motion of the rotor can be represented as:

$$\mathbf{x}_{\text{rigid}} = \mathbf{X}_{\text{bp}} + R(\mathbf{X} - \mathbf{X}_{\text{bp}})$$

Therefore, displacement caused only by deformation can be obtained by subtracting the rigid motion from the total displacement

$$\mathbf{u}_d = \chi(\mathbf{X}, t) - \mathbf{x}_{\text{rigid}} = R\mathbf{u}_r$$

Taking the time derivative of Equation 3-1, the velocity at a point on the rotor in the fixed frame is

$$\begin{aligned} \frac{\partial \chi(\mathbf{X}, t)}{\partial t} &= \frac{\partial R}{\partial t}(\mathbf{X} + \mathbf{u}_r - \mathbf{X}_{\text{bp}}) + R\left(\frac{\partial \mathbf{u}_r}{\partial t}\right) = \\ &R\left[\tilde{\Omega}_r(\mathbf{X} + \mathbf{u}_r - \mathbf{X}_{\text{bp}}) + \frac{\partial \mathbf{u}_r}{\partial t}\right] \end{aligned} \quad (3-3)$$

Here, $\tilde{\Omega}_r = R^T \dot{R}$ is a skew-symmetric tensor corresponding to the angular velocity.

Similarly, the acceleration of a point on the rotor in the fixed frame is given by

$$\frac{\partial^2 \chi(\mathbf{X}, t)}{\partial t^2} = R\left[\left(\frac{\partial \tilde{\Omega}_r}{\partial t} + \tilde{\Omega}_r^2\right)(\mathbf{X} + \mathbf{u}_r - \mathbf{X}_{\text{bp}}) + 2\tilde{\Omega}_r \frac{\partial \mathbf{u}_r}{\partial t} + \frac{\partial^2 \mathbf{u}_r}{\partial t^2}\right] = R\mathbf{a}_r \quad (3-4)$$

The total acceleration \mathbf{a}_r is accounting for the effect of the rotation of the rotor observed in the body-fixed frame and is given by

$$\begin{aligned} \mathbf{a}_r &= \frac{\partial \Omega_r}{\partial t} \times (\mathbf{X} + \mathbf{u}_r - \mathbf{X}_{\text{bp}}) + \Omega_r \times \Omega_r \times (\mathbf{X} + \mathbf{u}_r - \mathbf{X}_{\text{bp}}) + \\ &2\Omega_r \times \frac{\partial \mathbf{u}_r}{\partial t} + \frac{\partial^2 \mathbf{u}_r}{\partial t^2} \end{aligned}$$

The first term in the equation above corresponds to the Euler acceleration, the second to the centrifugal acceleration, and the third to the Coriolis acceleration. The last term corresponds to the acceleration without the effect of the rotation. Note that the acceleration also includes the spin softening effect, because centrifugal and Coriolis acceleration terms also contain the effect of deformation.

The relation between the angular velocity vector Ω_r corresponding to the skew-symmetric tensor $\tilde{\Omega}_r$ with the rotation vector can be obtained by considering

$$\begin{aligned}\tilde{\Omega}_r \mathbf{a} &= \Omega_r \times \mathbf{a} = R^T \left(\frac{dR}{dt} \right) \mathbf{a} = \\ & \left[\left(\frac{d\theta}{dt} \right) \frac{\theta}{\theta} + \frac{\sin\theta}{\theta} \left(\frac{d\theta}{dt} - \frac{d\theta\theta}{dt\theta} \right) - \left(\frac{1-\cos\theta}{\theta^2} \right) \left(\theta \times \frac{d\theta}{dt} \right) \right] \times \mathbf{a}\end{aligned}$$

Since \mathbf{a} is arbitrary,

$$\Omega_r = \left(\frac{d\theta}{dt} \right) \frac{\theta}{\theta} + \frac{\sin\theta}{\theta} \left(\frac{d\theta}{dt} - \frac{d\theta\theta}{dt\theta} \right) - \left(\frac{1-\cos\theta}{\theta^2} \right) \left(\theta \times \frac{d\theta}{dt} \right) \quad (3-5)$$

Using the relation

$$\theta \times \left(\theta \times \frac{d\theta}{dt} \right) = -\theta^2 \left(\frac{d\theta}{dt} - \frac{d\theta\theta}{dt\theta} \right)$$

Equation 3-5 can be written as

$$\Omega_r = \left[\mathbf{I} - \left(\frac{1-\cos\theta}{\theta^2} \right) \Theta + \left(\frac{\theta - \sin\theta}{\theta^3} \right) \Theta^2 \right] \frac{d\theta}{dt} = T^r \frac{d\theta}{dt} \quad (3-6)$$

in which Θ is the skew-symmetric tensor corresponding to the rotation vector θ . If the rotation is about a fixed axis \mathbf{e} , then the rotation vector can be written as

$$\theta = \theta \mathbf{e}$$

and

$$\Omega_r = \frac{d\theta}{dt} \mathbf{e}$$

Rotor Axis

This section aims to define the rotor axis in the Solid Rotor interface. There are two methods to specify the rotor axis:

- The first method is to specify two points, usually the locations of end supports, on the rotor. The line joining these points then defines the rotor axis.
- The second method is to specify an edge on the rotor corresponding to the physical axis of the rotor. If there is only one support, you can either specify the two points close to the support or use the second method to specify the edge representing the rotor axis.

The following sections describe the two methods to determine the rotor axis.

Support Locations

Let \mathbf{X}_1 and \mathbf{X}_2 be the position vectors of the points corresponding to the support locations. Then the rotor axis direction is

$$\mathbf{e}_1 = \frac{\mathbf{X}_2 - \mathbf{X}_1}{\|\mathbf{X}_2 - \mathbf{X}_1\|}$$

For a material point \mathbf{X} on the rotor, the corresponding material point on the rotor axis is

$$\mathbf{X}_{\text{ax}} = \mathbf{X}_1 + \{(\mathbf{X} - \mathbf{X}_1) \cdot \mathbf{e}_1\} \mathbf{e}_1$$

Edge

If the edge corresponding to the axis is specified, then \mathbf{X}_{ax} are the material coordinates \mathbf{X} on the edge. The axis direction is given by

$$\mathbf{e}_1 = \frac{\frac{d\mathbf{X}}{d\zeta_1}}{\left\| \frac{d\mathbf{X}}{d\zeta_1} \right\|}$$

where ζ_1 is the local coordinate along the edge representing the axis.

Change Rotor Speed

The speed of the rotor is usually specified in the interface settings. If the analysis consists of a single rotor or multiple rotors rotating at the same speed, you do not need the **Change Rotor Speed** node. However, there are also cases where the rotors in the system rotate at different speeds. Use this feature to selectively specify the speed of each rotor in a multirotor system.

Geared Rotor System

Geared rotor system have multiple rotors with pair of gears connecting them together. The speed of the shafts that are connected through the gears have a specific ratio called the gear ratio, which is the number of teeth per gear. The **Change Rotor Speed** feature can be used to specify the angular speeds of the respective rotors consistent with the gear ratio.

Formulation of Equilibrium Equations

In this section:

- Transformation of Some Quantities
- Equation Implementation

Transformation of Some Quantities

The deformation gradient in the fixed frame is obtained by taking the derivative of Equation 3-1 with respect to \mathbf{X} .

$$\frac{\partial \chi(\mathbf{X}, t)}{\partial \mathbf{X}} = \frac{\partial}{\partial \mathbf{X}}(\mathbf{X}_{bp} + R(\mathbf{X} + \mathbf{u}_r - \mathbf{X}_{bp})) = R \frac{\partial}{\partial \mathbf{X}}(\mathbf{X} + \mathbf{u}_r) = RF_r \quad (3-7)$$

where F_r is the deformation gradient in the rotating frame.

Using this expression for the deformation gradient, the relation between the Green-Lagrange strain in the fixed and corotating frames is

$$E = \frac{1}{2}(F^T F - I) = \frac{1}{2}(F_r^T R^T R F_r - I) = \frac{1}{2}(F_r^T F_r - I) = E_r$$

A traction vector transforms between different frames like a vector. Therefore, the relation between the traction vector in the fixed and corotating frames is

$$\mathbf{t}(\mathbf{x}, t, \mathbf{n}) = R \mathbf{t}_r(\mathbf{x}_r, t, \mathbf{n}_r)$$

where $\mathbf{n} = R \mathbf{n}_r$. Using Cauchy's relation, $\mathbf{t} = \boldsymbol{\sigma} \mathbf{n}$, the Cauchy stress tensor transforms as

$$\boldsymbol{\sigma} = R \boldsymbol{\sigma}_r R^T$$

The first Piola-Kirchhoff tensor in the fixed frame is related to the same tensor in the corotating frame by

$$P = J \boldsymbol{\sigma} F^{-T} = J(R \boldsymbol{\sigma}_r R^T)(R F_r)^{-T} = J R \boldsymbol{\sigma}_r F_r^{-T} = R P_r$$

Equation Implementation

The equilibrium equations for rotordynamics are based on Newton's second law. It is usually written using a spatial formulation in terms of the Cauchy stress tensor $\boldsymbol{\sigma}$:

$$\rho \frac{\partial^2 \mathbf{u}}{\partial t^2} = \nabla_x \cdot \boldsymbol{\sigma} + \mathbf{f}_V$$

Here, \mathbf{f}_V is a body force per unit deformed volume, and ρ is the current mass density. For the material frame formulation used in COMSOL Multiphysics, it is more appropriate to use a Lagrangian version of the equation:

$$\rho_0 \frac{\partial^2 \boldsymbol{\chi}(\mathbf{X}, t)}{\partial t^2} = \nabla_X \cdot \mathbf{P} + \mathbf{F}_V \quad (3-8)$$

Here, the first Piola-Kirchhoff tensor, \mathbf{P} , is used. The \mathbf{F}_V term is the body force with the components in the current configuration but given with respect to undeformed volume, and ρ_0 is initial mass density. Also note that the gradient operators are not the same. In the first case, the gradient is taken with respect to spatial coordinates, and in the second case it is taken with respect to material coordinates. Considering that [Equation 3-8](#) is valid in an inertial frame, the fixed-to-corotating frame transformation and [Equation 3-4](#) are used to write [Equation 3-8](#) in the corotating frame as:

$$\rho_0 \mathbf{a}_r = \nabla_X \cdot \mathbf{P}_r + \mathbf{F}_{rV} = \nabla_X \cdot (\mathbf{F}_r \mathbf{S}_r) + \mathbf{F}_{rV} \quad (3-9)$$

All the variables in [Equation 3-9](#) are interpreted in the corotating frame. Here, \mathbf{S}_r is the second Piola-Kirchhoff stress tensor, and \mathbf{F}_r is the deformation gradient tensor. The COMSOL Multiphysics implementation of the equations in the Solid Rotor interface is, however, not based on the equation of motion directly but rather on the *principle of virtual work*.

The principle of virtual work states that the sum of the internal virtual work and the external virtual work are equal. The internal virtual work is the work done by the current stress state on a kinematically admissible variation in strains. The external virtual work is the work done by all forces (acting on domains, boundaries, edges, or points) when multiplied with the variation in displacements corresponding to the variation in strains. The virtual displacements $\delta \mathbf{u}_r$ are in the finite element formulation represented by the `test()` operator in COMSOL Multiphysics. For a transient case, the virtual work δW is written as

$$\delta W = \int_V (-\delta \boldsymbol{\varepsilon} : \boldsymbol{\sigma} + \delta \mathbf{u}_r \cdot \mathbf{F}_{rV} - \rho_0 \delta \mathbf{u}_r \cdot \mathbf{a}_r) dV + \int_S (\delta \mathbf{u}_r \cdot \mathbf{F}_{rS}) dS + \int_L (\delta \mathbf{u}_r \cdot \mathbf{F}_{rL}) dL + \sum_P \delta \mathbf{u}_r \cdot \mathbf{F}_{rP} \quad (3-10)$$

As the equation is formulated in the material frame, all of the integrals are taken over the undeformed geometry. Since the Solid Rotor interface uses a geometrically linear formulation, all of the stress measures converge to the same engineering stress. The strain, $\boldsymbol{\varepsilon}$, is interpreted as engineering strain.

The Solid Rotor interface supports stationary, time-dependent, and eigenfrequency analyses. For stationary analyses, the acceleration term is reduced to

$$\mathbf{a}_r = \boldsymbol{\Omega}_r \times \{ \boldsymbol{\Omega}_r \times (\mathbf{x}_r - \mathbf{X}_{bp}) \}$$

For eigenfrequency analyses, the acceleration term is

$$\mathbf{a}_r = (j\omega)^2 \mathbf{u}_r + 2(j\omega)\boldsymbol{\Omega}_r \times \mathbf{u}_r$$

Damping

For dynamic problems, damping in the structure is an important property. In this section, the theory for Rayleigh damping is described. For other types of damping, see the *Structural Mechanics Module User's Guide*.

Rayleigh Damping

Rayleigh damping is described by two coefficients: the mass damping coefficient α_{dM} and the stiffness damping coefficient β_{dK} . Rayleigh damping gives the following contribution to the virtual work:

$$\delta W = \int_V \left[-\beta_{dK} \delta(\nabla \mathbf{u}_r) : \frac{\partial \mathbf{P}_r}{\partial \mathbf{t}} - \alpha_{dM} \rho \delta \mathbf{u} \cdot \frac{\partial \boldsymbol{\chi}}{\partial \mathbf{t}} \right] dV$$

Simplifying the inertia-proportional damping term in the above equation in terms of corotating frame variables results in

$$\delta W = \int_V \left[-\beta_{dK} \delta(\nabla \mathbf{u}_r) : \frac{\partial \mathbf{P}_r}{\partial \mathbf{t}} - \alpha_{dM} \rho \delta \mathbf{u}_r \cdot \left\{ \frac{\partial \mathbf{u}_r}{\partial \mathbf{t}} + \boldsymbol{\Omega}_r \times (\mathbf{x}_r - \mathbf{X}_{bp}) \right\} \right] dV$$

where the equality $\delta \mathbf{u} = \mathbf{R} \delta \mathbf{u}_r$ is used.

For the stationary case, it is simplified to

$$\delta W = \int_V [-\alpha_{dM} \rho \delta \mathbf{u}_r \cdot \{\boldsymbol{\Omega}_r \times (\mathbf{x}_r - \mathbf{X}_{bp})\}] dV$$

In a frequency domain analysis, the contribution to the virtual work is

$$\delta W = (i\omega) \int_V [-\beta_{dK} \delta(\nabla \mathbf{u}_r) : \mathbf{P}_r - \alpha_{dM} \rho \delta \mathbf{u}_r \cdot \mathbf{u}_r] dV$$

Since Rayleigh damping is added directly to the virtual work equation, it does not affect the constitutive relation. As a consequence, the stresses and strains for a linear elastic material will still be in phase. This stands in contrast to other damping models.

Rigid Domain

A Rigid Domain, or a rigid body, is an idealization of a body in which the deformation is neglected. In other words, the distance between any two given points of a rigid body remains constant in time regardless of any external forces acting on it. An object can be assumed to be perfectly rigid if its flexibility can be neglected in comparison with other flexibilities in the system, and when there is no need to compute the stress in the object.



For details about the theory of a rigid domain, see [Rigid Domain Model](#) in the *Structural Mechanics Module User's Guide*.

The implementation of the rigid domain in the Rotordynamics Module differs from the Structural Mechanics Module in terms of the contribution to the virtual work due to inertial forces. In the Structural Mechanics Module, the rigid domain is modeled in a space-fixed frame. In the Rotordynamics Module, however, it is modeled in a rotating frame associated with the rotor rotation. Therefore, some frame acceleration terms also contribute to the virtual work. In a frame rotating with angular velocity Ω , this additional contribution to the virtual work is:

$$\delta W_k = -m \mathbf{a}_f \cdot \delta \mathbf{u}_m - A_f E_m : \delta R = -m \mathbf{a}_f \cdot \delta \mathbf{u}_m - \mathbf{M}_f \cdot \delta \vartheta$$

where

$$\mathbf{a}_f = \Omega \times (\Omega \times \mathbf{x}_{mp}) + \frac{\partial \Omega}{\partial t} \times \mathbf{x}_{mp} + 2\Omega \times \frac{\partial \mathbf{u}_m}{\partial t}$$

$$A_f = (\tilde{\Omega}^2 + \tilde{\Omega})R + 2\tilde{\Omega}\dot{R}$$

$$\mathbf{M}_f = RI_m R^T (\dot{\Omega} + \Omega \times \dot{\vartheta}) + (\Omega + \dot{\vartheta}) \times RI_m R^T (\Omega + \dot{\vartheta})$$

with $\mathbf{x}_{mp} = \mathbf{X}_m + \mathbf{u}_m - \mathbf{X}_{bp}$ and

$$I_m = \int_V \rho [(X - X_m) \cdot (X - X_m)I - (X - X_m) \otimes (X - X_m)] dV$$

$$E_m = \int_V \rho (X - X_m) \otimes (X - X_m) dV$$

$$\tilde{\Omega} = \Omega \times I$$

where ϑ is the rotation vector corresponding to the rotation matrix R , which represents the rotation of the rigid body in the rotating frame.

Fixed Axial Rotation

Rotors are often subjected to torsional loads. Therefore, the rotor transfers the torsional load while it is rotating about its own axis. The bearings that support the rotor do not constrain the axial rotation of the rotor. Since you analyze the rotor in the corotating frame during the rotordynamic analysis, you need a cross section on the rotor as a reference about which torsional vibration can be studied. The [Fixed Axial Rotation](#) node is a default node in the Solid Rotor interface that provides the method to constrain the axial rotation of the rotor at a given cross section. In general, each cross section along the rotor can have an axial rotation that differs from the rigid body rotation due to twist in the rotor. The nonrigid part of the axial rotation is constrained by this feature.

If the deformational displacement is approximated by a rigid body map, then

$$\mathbf{u}_r = \mathbf{u}_{r,ax} + \theta_r \times (\mathbf{X} - \mathbf{X}_{ax})$$

Therefore, taking the cross product by $\mathbf{X} - \mathbf{X}_{ax}$ on both sides and integrating over the area, gives

$$I_A \theta_r = \int_A (\mathbf{X} - \mathbf{X}_{ax}) \times (\mathbf{u}_r - \mathbf{u}_{r,ax}) dA$$

The following constraint should be applied to fix the axial rotation:

$$\theta_r \cdot \mathbf{e}_1 = \mathbf{e}_1 \cdot (I_A)^{-1} \int_A (\mathbf{X} - \mathbf{X}_{ax}) \times (\mathbf{u}_{r,rot} - \mathbf{u}_{r,ax}) dA = 0$$

where

$$I_A = \int_A [\{ (\mathbf{X} - \mathbf{X}_c) \cdot (\mathbf{X} - \mathbf{X}_c) \} I - (\mathbf{X} - \mathbf{X}_c) \otimes (\mathbf{X} - \mathbf{X}_c)] dA$$

$$\mathbf{u}_{r,ax} = \frac{\int_A \mathbf{u}_r dA}{\int_A dA}$$

and

$$\mathbf{X}_c = \frac{\int \mathbf{X}dA}{\int_A dA}$$

Weak Constraint

The constraint described above involves many degrees of freedom. The internal constraint elimination algorithm will have to solve a large system of equations, which may lead to excessive memory usage or inaccuracies. If this happens, select the **Use weak constraints** check box (enabled by **Advanced Physics Options**) to use the weak form of the constraint. The Lagrange multiplier, `<phys>.<feat>.th1_lm`, for this constraint provides the reaction torque on the cross section.

Loads

In this section:

- [Distributed Loads](#)
- [Gravity](#)

Distributed Loads

The direction of the explicitly applied distributed load should be given with reference to a global or local coordinate system in the spatial (fixed) or corotating frame. The magnitude of the load must be with reference to the undeformed reference (or material) area. Since the reference area does not depend on the material or corotating frame, the magnitude of the load remains unaffected with respect to the frame in which it is applied. However, the direction of the load will depend strongly on the frame in which it is applied. The relation between the true force \mathbf{f} acting on the current area da and the specified distributed load \mathbf{F} acting on the material area dA is $\mathbf{f}da = \mathbf{F}_r dA$. If the load is specified in the corotating frame, then the relation changes to $\mathbf{f}da = R\mathbf{F}dA$. Therefore, the contribution to the virtual work for a distributed force specified on a surface is

$$\delta W = \int_A \delta \mathbf{u} \cdot \mathbf{F}_A dA = \int_A \delta \mathbf{u}_r \cdot R^T \mathbf{F}_A dA = \int_A \delta \mathbf{u}_r \cdot \mathbf{F}_{rA} dA$$

In a stationary analysis, irrespective of the choice of the frame, a load is always considered to act in the corotating frame.

When a pressure load, p , acts on the rotor, the true force on the surface element acts with the magnitude p over the current area da in the normal direction \mathbf{n} :

$$\mathbf{f} = p\mathbf{n}da$$

Therefore, the pressure load type specifies the distributed load as

$$\mathbf{F} = p\mathbf{n} \frac{da}{dA}$$

where both normal \mathbf{n} and area element da are functions of the current displacement field. Another view of how to interpret the load is to express it in terms of the first Piola-Kirchhoff stress tensor P via the following formula:

$$\mathbf{F} = P\mathbf{n}_0$$

where the normal \mathbf{n}_0 corresponds to the undeformed surface element. Such a force vector is often referred to as *nominal traction*.

Gravity

You can add the [Gravity](#) node to create the load caused by gravity. This gives load contribution from all the nodes in the physics interface that have density or mass, such as **Linear Elastic Material**, **Added Mass**, or **Point Mass**.

In the following, the mass density ρ should be considered to be generalized. It can represent mass per unit volume, mass per unit area, mass per unit length, or mass itself, depending on the dimensionality of the object giving the contribution. The gravity acts in a fixed spatial direction \mathbf{e}_g . The intensity in the corotating frame is:

$$\mathbf{g} = \rho g \mathbf{R}^T \mathbf{e}_g$$

where g is the acceleration of gravity. The action of gravity can also be presented as the linearly accelerated frame of reference. Thus it can be accounted for as a contribution into the total acceleration via the frame acceleration term given by:

$$\mathbf{a}_f = -\mathbf{g}$$

Due to the presence of the transformation matrix \mathbf{R} , which is time dependent, gravity in the Solid Rotor interface is only meaningful in a dynamic analysis. However, for a stationary analysis, the component of gravity that acts along the axis of the rotor is still considered, since it is independent of the rotation. For an eigenfrequency analysis, gravity has no effect.

Bearings and Foundations

In this section:

- [Journal Bearing](#)
- [Thrust Bearing](#)
- [Radial Roller Bearing](#)
- [Fixed Foundation](#)
- [Moving Foundation](#)
- [Flexible Foundation](#)
- [Squeeze Film Damper](#)

Journal Bearing

The purpose of journal bearings is to support the rotor against its lateral movement. Due to the finite length of the bearings, as a side effect, they also offer a resistance to the bending of the rotor about the two lateral directions. If the bearings are very short when compared to the overall length of the rotor, the bending resistance of the bearings can be neglected. Modeling of the journal bearings in COMSOL Multiphysics can be done in two ways: get the equivalent stiffness and damping constants or consider the equivalent resistive forces and moments offered by the bearing. There is also a special category where the journal bearing is assumed to offer infinite resistance to the lateral and bending motion of the journal. This is called a no-clearance bearing.

For the purpose of implementation, the motion of the journal in the Solid Rotor interface is represented by a displacement at the center of the journal and a rotation around it. To obtain these quantities from the displacement field of the journal, it is assumed that the displacement of the journal in the rotating frame can be approximated by a rigid map:

$$\mathbf{u}_{r,J} = \mathbf{u}_{r,c} + \theta_{r,c} \times (\mathbf{X} - \mathbf{X}_c) \quad (3-11)$$

The displacement at the center of the journal $\mathbf{u}_{r,c}$ can be obtained by:

$$\mathbf{u}_{r,c} = \frac{\int \mathbf{u}_r dA}{\int_A dA}$$

and the rotation of the journal can be obtained by first taking the cross product by $\mathbf{X}-\mathbf{X}_c$ on both sides of Equation 3-11 and integrating over the area:

$$\theta_{r,c} = (I_A)^{-1} \int_A (\mathbf{X}-\mathbf{X}_c) \times (\mathbf{u}_r - \mathbf{u}_{r,c}) dA$$

with

$$I_A = \int_A [\{ (\mathbf{X}-\mathbf{X}_c) \cdot (\mathbf{X}-\mathbf{X}_c) \} I - (\mathbf{X}-\mathbf{X}_c) \otimes (\mathbf{X}-\mathbf{X}_c)] dA$$

In the expressions above, \mathbf{X}_c is the coordinate of the center of the journal given by

$$\mathbf{X}_c = \frac{\int \mathbf{X} dA}{\int_A dA}$$

The displacement of the journal, which affects and in turn is affected by the bearing operation, is the displacement excluding the effect of the axial rotation of the rotor. In a spatial (fixed) frame, this is given by

$$\mathbf{u}_J = R \mathbf{u}_{r,J}$$

The relative displacement of the journal axis with respect to the foundation in the spatial frame is given by

$$\mathbf{u}_d = \mathbf{u}_J - \mathbf{u}_{fd} = R \mathbf{u}_{r,J} - \mathbf{u}_{fd}$$

Here, \mathbf{u}_{fd} is the displacement field of the foundation in the spatial frame.

$$\mathbf{u}_{fd} = \mathbf{u}_f + \theta_f \times (\mathbf{X} - \mathbf{X}_c)$$

In the cases where deformation of the journal is significant, the displacement field on the journal surface should be considered instead of a linearized displacement of the journal axis:

$$\mathbf{u}_d = R \mathbf{u}_r - \mathbf{u}_{fd}$$

The lateral displacement components at the center of the journal, with respect to the foundation in the bearing lateral directions, are

$$u_{d2} = (R\mathbf{u}_{r,c} - \mathbf{u}_f) \cdot \mathbf{e}_2^b$$

and

$$u_{d3} = (R\mathbf{u}_{r,c} - \mathbf{u}_f) \cdot \mathbf{e}_3^b$$

The rotation components of the journal relative to the foundation about the bearing lateral axes are

$$\theta_{d2} = (R\theta_{r,c} - \theta_f) \cdot \mathbf{e}_2^b$$

and

$$\theta_{d3} = (R\theta_{r,c} - \theta_f) \cdot \mathbf{e}_3^b$$

in which \mathbf{u}_f and θ_f are the displacement and rotation vectors, respectively, of the bearing foundation at the center of the bearing.

For the Solid Rotor interface, the following methods are provided to model journal bearings:

- [No Clearance](#)
- [Plain Hydrodynamic](#)
- [Total Spring and Damping Constant](#)
- [Total Force and Moment](#)
- [Force Per Unit Area](#)

NO CLEARANCE

In this method, it is assumed that there is no clearance between the journal and the bushing of the bearing. Therefore, the relative motion between the journal and foundation is constrained to zero in the lateral direction. The following constraints are applied:

$$\mathbf{u}_d \cdot \mathbf{e}_2^b = 0$$

$$\mathbf{u}_d \cdot \mathbf{e}_3^b = 0$$

PLAIN HYDRODYNAMIC

This method models a fluid-lubricated plain journal bearing. Linearized bearing dynamic coefficients to model the effect of the fluid film on the journal motion are obtained in Ref. 1. These are given by

$$K_{22} = K_0 \frac{\varepsilon_0 \{ 16\varepsilon_0^2 + \pi^2 (2 - \varepsilon_0^2) \}}{(1 - \varepsilon_0^2)^2 Q}$$

$$K_{23} = K_0 \frac{\pi \{ \pi^2 (1 - \varepsilon_0^2)^2 - 16\varepsilon_0^4 \}}{4(1 - \varepsilon_0^2)^{5/2} Q}$$

$$K_{32} = -K_0 \frac{\pi \{ \pi^2 (1 + 2\varepsilon_0^2)(1 - \varepsilon_0^2) + 32\varepsilon_0^2(1 + \varepsilon_0^2) \}}{4(1 - \varepsilon_0^2)^{5/2} Q}$$

$$K_{33} = K_0 \frac{\varepsilon_0 \{ \pi^2 (1 + 2\varepsilon_0^2)(1 - \varepsilon_0^2) + 32\varepsilon_0^2(1 + \varepsilon_0^2) \}}{(1 - \varepsilon_0^2)^3 Q}$$

and

$$C_{22} = C_0 \frac{\pi \{ \pi^2 (1 + 2\varepsilon_0^2) - 16\varepsilon_0^2 \}}{2(1 - \varepsilon_0^2)^{3/2} Q}$$

$$C_{23} = C_{32} = -C_0 \frac{2\varepsilon_0 \{ \pi^2 (1 + 2\varepsilon_0^2) - 16\varepsilon_0^2 \}}{(1 - \varepsilon_0^2)^2 Q}$$

$$C_{33} = C_0 \frac{\pi \{ 48\varepsilon_0^2 + \pi^2 (1 - \varepsilon_0^2)^2 \}}{2(1 - \varepsilon_0^2)^{5/2} Q}$$

where $K_0 = \mu\Omega R(L/C)^3$, $C_0 = \mu R(L/C)^3$ and $Q = 16\varepsilon_0^2 + \pi^2(1 - \varepsilon_0^2)$.

Here, μ is the dynamic viscosity of the lubricant, Ω is the angular speed of the rotor, R is the radius of the journal, C is the clearance between the journal and bushing when both are concentric, ε_0 is the relative eccentricity and is given by $\varepsilon_0 = e/C$, and e is the eccentricity of the journal defined as

$$e = \sqrt{u_{d2}^2 + u_{d3}^2}$$

The attitude angle, which represents the direction in which the journal center moves relative to the bushing center with respect to the local y -direction, is defined as

$$\psi = \text{atan}\left(\frac{u_{d3}}{u_{d2}}\right)$$

For a dynamic analysis, the contribution to the virtual work from the bearing in this case is

$$\delta W = \int_A -\frac{1}{A} \left\{ \left(\begin{bmatrix} K_{22} & K_{23} \\ K_{32} & K_{33} \end{bmatrix} \begin{bmatrix} u_{d2} \\ u_{d3} \end{bmatrix} + \begin{bmatrix} C_{22} & C_{23} \\ C_{32} & C_{33} \end{bmatrix} \begin{bmatrix} \frac{\partial u_{d2}}{\partial t} \\ \frac{\partial u_{d3}}{\partial t} \end{bmatrix} \right) \cdot \begin{bmatrix} \delta u_{d2} \\ \delta u_{d3} \end{bmatrix} \right\} dA$$

In a stationary case, the contribution due to damping is dropped in the expression above. For a frequency domain analysis, the contribution to the virtual work is

$$\delta W = \int_A -\frac{1}{A} \left\{ \left(\begin{bmatrix} K_{22} & K_{23} \\ K_{32} & K_{33} \end{bmatrix} \begin{bmatrix} u_{d2} \\ u_{d3} \end{bmatrix} + j\omega \begin{bmatrix} C_{22} & C_{23} \\ C_{32} & C_{33} \end{bmatrix} \begin{bmatrix} u_{d2} \\ u_{d3} \end{bmatrix} \right) \cdot \begin{bmatrix} \delta u_{d2} \\ \delta u_{d3} \end{bmatrix} \right\} dA$$

TOTAL SPRING AND DAMPING CONSTANT

In this case, spring and damping constants are needed explicitly to model the bearing. There is also an option to include the translational-rotational coupling both for the spring constant and the damping constant. In the general case, the following inputs are needed: k_u , k_θ , $k_{u\theta}$, and $k_{\theta u}$ for stiffness and c_u , c_θ , $c_{u\theta}$, and $c_{\theta u}$ for damping. These inputs are all 2x2 matrices. The contribution to the virtual work is:

$$\delta W = -\frac{1}{A} \int \left(\left(k_u \mathbf{u}_b + k_{u\theta} \theta_b + c_u \frac{\partial \mathbf{u}_b}{\partial t} + c_{u\theta} \frac{\partial \theta_b}{\partial t} \right) \cdot \delta \mathbf{u}_b + \left(k_\theta \theta_b + k_{\theta u} \mathbf{u}_b + c_\theta \frac{\partial \theta_b}{\partial t} + c_{\theta u} \frac{\partial \mathbf{u}_b}{\partial t} \right) \cdot \delta \theta_b \right) dA$$

where

$$\mathbf{u}_b = \begin{bmatrix} u_{d2} \\ u_{d3} \end{bmatrix}$$

and

$$\theta_b = \begin{bmatrix} \theta_{d2} \\ \theta_{d3} \end{bmatrix}$$

In a frequency domain analysis, the contribution to the virtual work is modified to

$$\delta W = -\frac{1}{A} \int_A ((k_u \mathbf{u}_b + k_{u\theta} \theta_b + j\omega c_u \mathbf{u}_b + j\omega c_{u\theta} \theta_b) \cdot \delta \mathbf{u}_b + (k_\theta \theta_b + k_{\theta u} \mathbf{u}_b + j\omega c_\theta \theta_b + j\omega c_{\theta u} \mathbf{u}_b) \cdot \delta \theta_b) dA$$

In a stationary analysis, the terms corresponding to damping are dropped.

Default values for the inputs k_θ and c_θ are provided assuming that k_u and c_u are constants and that the displacement of the journal varies linearly along the axis. The default values for these inputs are

$$k_\theta = \frac{E_{11}}{A} \begin{bmatrix} k_{u,33} & -k_{u,32} \\ -k_{u,23} & k_{u,22} \end{bmatrix}$$

and

$$c_\theta = \frac{E_{11}}{A} \begin{bmatrix} c_{u,33} & -c_{u,32} \\ -c_{u,23} & c_{u,22} \end{bmatrix}$$

where

$$E_{ij} = \int_A \{(\mathbf{X} - \mathbf{X}_c) \cdot \mathbf{e}_i\} \{(\mathbf{X} - \mathbf{X}_c) \cdot \mathbf{e}_j\} dA$$

TOTAL FORCE AND MOMENT

A bearing can also be modeled by directly specifying the total force and moment it applies on the journal. These forces and moments are generally functions of the journal displacement and rotation and their time derivatives. Total force \mathbf{F} (2x1) and total moment \mathbf{M} (2x1) are the inputs. The contribution to the virtual work in this case is

$$\delta W = -\frac{1}{A} \int_A (\mathbf{F} \cdot \delta \mathbf{u}_b + \mathbf{M} \cdot \delta \theta_b) dA$$

FORCE PER UNIT AREA

Instead of specifying the total force and moment on the journal, a distributed force on the journal surface can also be specified. The force per unit area, \mathbf{F}_A (2x1), is the input. In such a case, the contribution to the virtual work is written as

$$\delta W = -\int_A (\mathbf{F}_A \cdot \delta \mathbf{u}_d) dA$$

Thrust Bearing

The purpose of thrust bearings is to restrict the axial motion of the rotor. Due to the finite area of the thrust bearings, as a side effect, they also offer a resistance to the bending of the rotor about the two lateral directions. Just as for journal bearings, modeling of thrust bearings can be done in two ways — either by specifying the equivalent stiffness and damping constants or by specifying the equivalent resistive forces and moments. There is also a special category where the thrust bearing is assumed to offer infinite resistance to the axial and bending motion of the collar. This is called a no-clearance thrust bearing.

For the purpose of implementation, the motion of the collar in the Solid Rotor interface is represented by the displacement at the center of the collar and a rotation around it. To obtain these quantities from the displacement field of the collar, it is assumed that the relative displacement of the collar with respect to the foundation can be written in terms of the displacement and rotation at the center of the collar in the following way:

$$\mathbf{u}_{r,c} = \mathbf{u}_{r,c} + \theta_{r,c} \times (\mathbf{X} - \mathbf{X}_c) \quad (3-12)$$

The displacement at the center of the collar $\mathbf{u}_{r,c}$ can be obtained by:

$$\mathbf{u}_{r,c} = \frac{\int_A \mathbf{u}_r dA}{\int_A dA}$$

and the rotation of the collar can be obtained by first taking the cross product by $\mathbf{X} - \mathbf{X}_c$ on both sides of Equation 3-12 and then integrating over the area:

$$\theta_{r,c} = (I_A)^{-1} \int_A (\mathbf{X} - \mathbf{X}_c) \times (\mathbf{u}_r - \mathbf{u}_{r,c}) dA$$

Here

$$I_A = \int_A [\{ (\mathbf{X} - \mathbf{X}_c) \cdot (\mathbf{X} - \mathbf{X}_c) \} I - (\mathbf{X} - \mathbf{X}_c) \otimes (\mathbf{X} - \mathbf{X}_c)] dA$$

In these expressions, \mathbf{X}_c is the coordinate of the center of the journal given by

$$\mathbf{X}_c = \frac{\int \mathbf{X} dA}{\int_A dA}$$

The displacement of the collar in the spatial (fixed) frame is given by

$$\mathbf{u}_C = R \mathbf{u}_{r,C}$$

Further, since the thrust bearing only supports the axial motion of the collar, the displacement component in the axial direction is given as

$$u_1 = \mathbf{u}_C \cdot \mathbf{e}_1 = \mathbf{u}_{r,C} \cdot \mathbf{e}_1$$

Here, the fact that axial direction is independent of the rotation is used. The relative axial displacement of the collar with respect to the foundation is then given by

$$u_{d1} = (\mathbf{u}_C - \mathbf{u}_f) \cdot \mathbf{e}_1 = u_1 - u_{1,f}$$

The components of the collar rotation relative to the foundation about the bearing lateral axes are

$$\theta_{d2} = (R\theta_{r,c} - \theta_f) \cdot \mathbf{e}_2^b$$

and

$$\theta_{d3} = (R\theta_{r,c} - \theta_f) \cdot \mathbf{e}_3^b$$

in which \mathbf{u}_f and θ_f are the displacement and rotation vectors, respectively, of the bearing foundation at the center of the bearing.

If the deformational displacement of the collar in the axial direction is important, then instead of the linearized displacement, the full displacement field of the collar is used:

$$\mathbf{u}_d = R \mathbf{u}_r - \mathbf{u}_{fd}$$

Here, \mathbf{u}_{fd} is the displacement field of the foundation in the spatial frame.

$$\mathbf{u}_{fd} = \mathbf{u}_f + \theta_f \times (\mathbf{X} - \mathbf{X}_c)$$

For the Solid Rotor interface, the following methods are provided to model thrust bearings:

- No Clearance
- Total Spring and Damping Constant
- Total Force and Moment
- Force Per Unit Area

NO CLEARANCE

In this method, it is assumed that there is no clearance between the collar and the foundation, and therefore the relative axial motion between the collar and foundation is constrained to zero. The following constraint is applied:

$$\mathbf{u}_d \cdot \mathbf{e}_1^b = 0$$

TOTAL SPRING AND DAMPING CONSTANT

In this case, spring and damping constants are needed explicitly to model the bearing. There is also an option to include the translational-rotational coupling for both the spring constant and the damping constant. In a general case, the following inputs are needed: k_u (1x1), k_θ (2x2), $k_{u\theta}$ (1x2), and $k_{\theta u}$ (2x1) for stiffness; and c_u (1x1), c_θ (2x2), $c_{u\theta}$ (1x2), and $c_{\theta u}$ (2x1) for damping. The contribution to the virtual work is:

$$\delta W = -\frac{1}{A} \int_A \left(\left(k_u u_{d1} + k_{u\theta} \theta_b + c_u \frac{\partial u_{d1}}{\partial t} + c_{u\theta} \frac{\partial \theta_b}{\partial t} \right) \cdot \delta u_{d1} + \left(k_\theta \theta_b + k_{\theta u} u_{d1} + c_\theta \frac{\partial \theta_b}{\partial t} + c_{\theta u} \frac{\partial u_{d1}}{\partial t} \right) \cdot \delta \theta_b \right) dA$$

where

$$\theta_b = \begin{bmatrix} \theta_{d2} \\ \theta_{d3} \end{bmatrix}$$

In a frequency domain analysis, the contribution to the virtual work is modified to

$$\delta W = -\frac{1}{A} \int_A ((k_u u_{d1} + k_{u\theta} \theta_b + j\omega c_u u_{d1} + j\omega c_{u\theta} \theta_b) \cdot \delta u_{d1} + (k_\theta \theta_b + k_{\theta u} u_{d1} + j\omega c_\theta \theta_b + j\omega c_{\theta u} u_{d1}) \cdot \delta \theta_b) dA$$

In a stationary analysis, the terms corresponding to damping are dropped.

Default values for the inputs k_θ and c_θ are provided assuming that k_u and c_u are constants and that the displacement of the collar varies linearly in the plane of the collar. The default values for these inputs are

$$k_\theta = \frac{k_u}{A} \begin{bmatrix} E_{33} & -E_{32} \\ -E_{23} & E_{22} \end{bmatrix}$$

and

$$c_\theta = \frac{c_u}{A} \begin{bmatrix} E_{33} & -E_{32} \\ -E_{23} & E_{22} \end{bmatrix}$$

where

$$E_{ij} = \int_A \{(\mathbf{X} - \mathbf{X}_c) \cdot \mathbf{e}_i\} \{(\mathbf{X} - \mathbf{X}_c) \cdot \mathbf{e}_j\} dA$$

TOTAL FORCE AND MOMENT

A bearing can also be modeled by directly specifying the total axial force and the bending moment it applies on the collar. These forces and moments are generally functions of the collar displacement and rotation and their time derivatives. Total force \mathbf{F}_{ax} (1x1) and total moment \mathbf{M} (2x1) are the inputs. The contribution to the virtual work is

$$\delta W = -\frac{1}{A} \int_A (\mathbf{F}_{ax} \cdot \delta u_{d1} + \mathbf{M} \cdot \delta \theta_b) dA$$

FORCE PER UNIT AREA

Instead of specifying the total force and moment on the journal, a distributed force on the journal surface can be specified. Force per unit area, $\mathbf{F}_{ax,A}$ (1x1), is the input. In such a case, the contribution to the virtual work is written as

$$\delta W = - \int_A F_{ax,A} (\delta \mathbf{u}_d \cdot \mathbf{e}_1^b) dA$$

Radial Roller Bearing

In this type of bearing, relative rotation between the two components is allowed by inserting rolling elements between them. These bearings typically consists of the inner race, rollers (ball or cylindrical rollers), and the outer race. The inner race is interference fitted on the shaft whereas the outer race is fixed to the casing. A cage is used to keep the rollers well separated.

During the operation, rollers are in contact with the inner and outer race surfaces and roll in between whenever there is a relative motion between these surfaces. Inner and outer surfaces can, in general, be curved in both the directions perpendicular to the normal. Therefore, modeling of roller bearings requires a detailed analysis of how the contact interaction takes places between the inner race and roller, and the roller and outer race. Contact between the rolling element and the races can be of two types, namely, a point contact such as contact between ball and races or a line contact such as contact between the cylindrical roller and races.

FORCE IN POINT CONTACT

Consider two solids having different radii of curvature in two tangential directions which are in point contact when no load is applied. Under the action of the load F , the contact area becomes elliptical. As a convention, let us assign the positive sign for the curvature of a convex surface and negative for a concave surface. The contact profile between the two solids A and B can be expressed in terms of the curvature sum, R , and curvature difference, R_d , as follows:

$$\frac{1}{R} = \frac{1}{R_1} + \frac{1}{R_2}$$

$$R_d = R \left(\frac{1}{R_1} - \frac{1}{R_2} \right)$$

Indices 1 and 2 represent the local tangent directions. R_1 and R_2 are the effective radius of curvatures of the contacting surfaces in the local direction given by:

$$\frac{1}{R_1} = \frac{1}{r_{A1}} + \frac{1}{r_{B1}}$$

$$\frac{1}{R_2} = \frac{1}{r_{A2}} + \frac{1}{r_{B2}}$$

The point of contact under the action of the load expands to an ellipse with semi-major axis, a_e , and semi-minor axis, b_e . The ellipticity parameter is defined as:

$$k_e = \frac{a_e}{b_e}$$

This ellipticity parameter can be defined in terms of the curvature difference, R_d , and elliptic integrals of first and second kind as follows:

$$k_e = \left[\frac{2\xi - \zeta(1 + R_d)}{\zeta(1 - R_d)} \right]$$

where ξ and ζ are the elliptic integrals of first and second kind, respectively, defined as:

$$\xi = \int_0^{\pi/2} \left[1 - \left(1 - \frac{1}{k_e^2} \right) (\sin \phi)^2 \right]^{-1/2} d\phi$$

$$\zeta = \int_0^{\pi/2} \left[1 - \left(1 - \frac{1}{k_e^2} \right) (\sin \phi)^2 \right]^{1/2} d\phi$$

An approximate formula for the ellipticity and elliptical integrals of first and second kind can be given as:

$$k_e = 1.0339 \left(\frac{R_2}{R_1} \right)^{0.6360}$$

$$\xi = 1.0003 + 0.5968 \left(\frac{R_1}{R_2} \right)$$

$$\zeta = 1.5277 + 0.6023 \log \left(\frac{R_2}{R_1} \right)$$

The contact stiffness for point contact then can be evaluated in terms of the elliptic integrals and ellipticity parameters as follows:

$$K_c = \pi k_e E' \sqrt{\frac{R\xi}{4.5\zeta^3}}$$

with E' defined as:

$$\frac{1}{E'} = \frac{1}{2} \left(\frac{1 - \nu_A^2}{E_A} + \frac{1 - \nu_B^2}{E_B} \right)$$

The contact force for the point contact is

$$F_c = K_c \delta^{3/2}$$

where δ is the penetration of the surfaces into each other.

Therefore, an equivalent stiffness corresponding to both inner and outer contacts is:

$$K_c^{\text{tot}} = \frac{1}{\left[\left(\frac{1}{K_c^{\text{in}}} \right)^{2/3} + \left(\frac{1}{K_c^{\text{out}}} \right)^{2/3} \right]^{3/2}}$$

Determination of the contact stiffness requires the radius of curvatures of the contacting surfaces in the tangential directions. For different point contact bearings these are given below.

Deep groove ball bearing

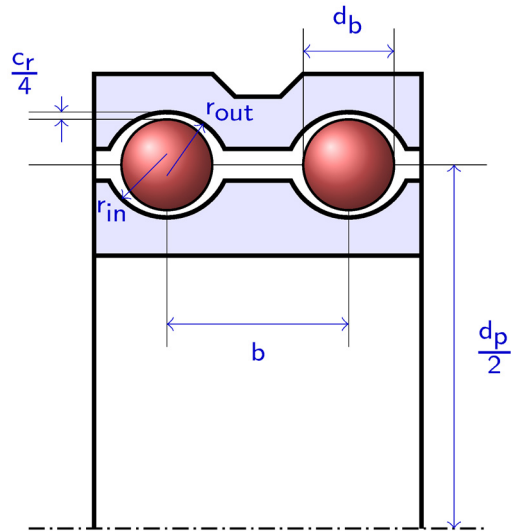

Ball and inner race contact:

$$r_{A1}^{in} = \frac{d_b}{2}$$

$$r_{A2}^{in} = \frac{d_b}{2}$$

$$r_{B1}^{in} = \frac{d_p}{2} - \frac{d_b}{2} - \frac{c_r}{4}$$

$$r_{B2}^{in} = -r^{in}$$

Ball and outer race contact:

$$r_{A1}^{\text{out}} = \frac{d_b}{2}$$

$$r_{A2}^{\text{out}} = \frac{d_b}{2}$$

$$r_{B1}^{\text{out}} = -\frac{d_p}{2} - \frac{d_b}{2} - \frac{c_r}{4}$$

$$r_{B2}^{\text{out}} = -r^{\text{out}}$$

Angular contact ball bearing

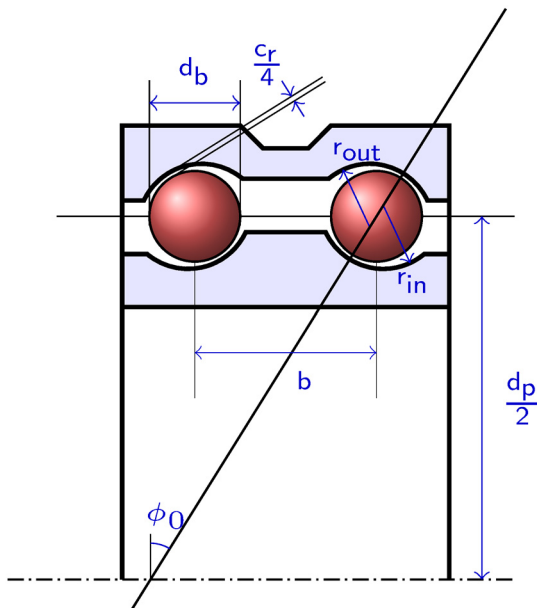

Ball and inner race contact:

$$r_{A1}^{\text{in}} = \frac{d_b}{2}$$

$$r_{A2}^{\text{in}} = \frac{d_b}{2}$$

$$r_{B1}^{\text{in}} = \frac{d_p}{2 \cos \phi_0} - \frac{d_b}{2} - \frac{c_r}{4}$$

$$r_{B2}^{\text{in}} = -r^{\text{in}}$$

Ball and outer race contact:

$$r_{A1}^{\text{out}} = \frac{d_b}{2}$$

$$r_{A2}^{\text{out}} = \frac{d_b}{2}$$

$$r_{B1}^{\text{out}} = -\frac{d_p}{2 \cos \phi_0} - \frac{d_b}{2} - \frac{c_r}{4}$$

$$r_{B2}^{\text{out}} = -r^{\text{out}}$$

Self aligning ball bearing

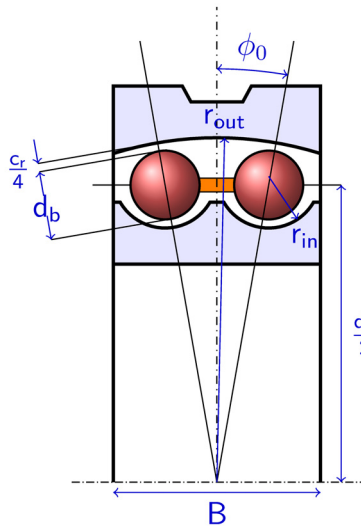

Ball and inner race contact:

$$r_{A1}^{\text{in}} = \frac{d_b}{2}$$

$$r_{A2}^{\text{in}} = \frac{d_b}{2}$$

$$r_{B1}^{\text{in}} = \frac{d_p}{2 \cos \phi_0} - \frac{d_b}{2} - \frac{c_r}{4}$$

$$r_{B2}^{\text{in}} = -r^{\text{in}}$$

Ball and outer race contact:

$$r_{A1}^{\text{out}} = \frac{d_b}{2}$$

$$r_{A2}^{\text{out}} = \frac{d_b}{2}$$

$$r_{B1}^{\text{out}} = -\frac{d_p}{2 \cos \phi_0} - \frac{d_b}{2} - \frac{c_r}{4}$$

$$r_{B2}^{\text{out}} = -r^{\text{out}}$$

Spherical roller bearing

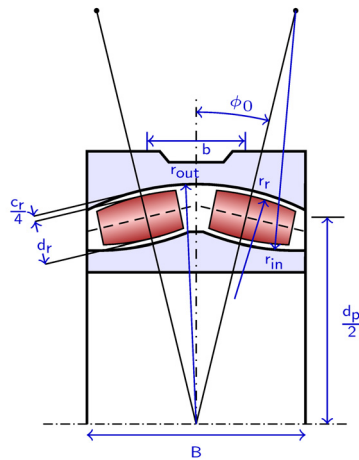

roller and inner race contact:

$$r_{A1}^{\text{in}} = \frac{d_r}{2}$$

$$r_{A2}^{\text{in}} = r_r$$

$$r_{B1}^{\text{in}} = \frac{d_p}{2 \cos \phi_0} - \frac{d_r}{2} - \frac{c_r}{4}$$

$$r_{B2}^{\text{in}} = -r^{\text{in}}$$

roller and outer race contact:

$$r_{A1}^{\text{out}} = \frac{d_r}{2}$$

$$r_{A2}^{\text{out}} = r_r$$

$$r_{B1}^{\text{out}} = -\frac{d_p}{2 \cos \phi_0} - \frac{d_r}{2} - \frac{c_r}{4}$$

$$r_{B2}^{\text{out}} = -r^{\text{out}}$$

FORCE IN LINE CONTACT

When two cylindrical surfaces with parallel axes come in contact, the contact formed is a line contact. In this case, the force, F , changes the contact area into rectangular. The width of the contact area, b , can be obtained in terms of the applied load, F , equivalent radius of curvature, R , and the effective elastic modulus, E' , as:

$$b = \left(\frac{8FR}{\pi E' L} \right)^{1/2}$$

where L is the length of cylindrical surfaces in contact. The normal displacement is given by:

$$\delta = \frac{2F}{\pi E' L} \left[1 + \log \left(\frac{\pi L^3 E'}{2FR} \right) \right]$$

The derivative of the normal displacement, δ , with respect to the load, F , gives the compliance. The inverse of the compliance is the stiffness of the contacting surfaces.

$$k = \frac{\pi E' L}{2 \log\left(\frac{\pi L^3 E'}{2 F R}\right)} = \frac{1}{\frac{\delta}{F} - \frac{2}{\pi E' L}}$$

However, this method requires iterations during the numerical solution to know the contact forces. Based on laboratory testing, Palmgren provided a simple expression to evaluate the contact forces as a function of indentation as:

$$F_c = 0.71069 \left(\frac{E'}{2}\right) L_{\text{eff}}^{8/9} \delta^{10/9} = K_c \delta^{10/9}$$

Therefore, the equivalent stiffness corresponding to the inner and outer contacts is:

$$K_c^{\text{tot}} = \frac{1}{\left[\left(\frac{1}{K_c^{\text{in}}}\right)^{9/10} + \left(\frac{1}{K_c^{\text{out}}}\right)^{9/10}\right]^{10/9}}$$

CONTACT DEFORMATION IN POINT CONTACT ROLLER BEARINGS

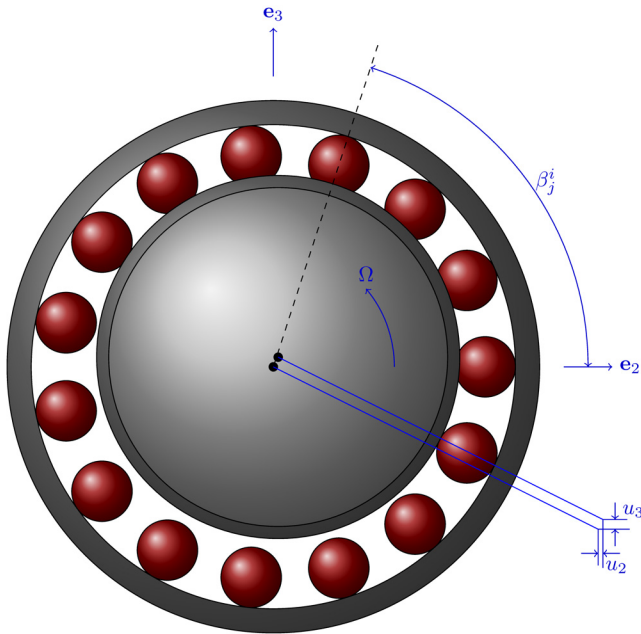

Figure 3-2: Front view of roller bearing.

Figure 3-2 shows the front view of a typical roller bearing. Due to the relative motion of the inner race and outer race, some of the rollers get loaded, whereas others get unloaded. This relative motion determines the contact indentation at different rollers. From Figure 3-3 the initial distance between the inner and outer race curvature centers is:

$$A_0 = |r_{\text{out}}| + |r_{\text{in}}| - d_r - \frac{c_r}{2}$$

along the line

$$\mathbf{e}_{j0}^i = (\pm \sin \phi_0) \mathbf{e}_1 + \cos \phi_0 \mathbf{e}_{rj}^i$$

Plus sign is for the second row and minus sign is for the first row of the rollers. In case of a single row bearing ϕ_0 becomes zero. \mathbf{e}_{rj}^i is the radial vector corresponding to the roller i in row j and is defined as:

$$\mathbf{e}_{rj}^i = \cos \beta_j^i \mathbf{e}_2 + \sin \beta_j^i \mathbf{e}_3$$

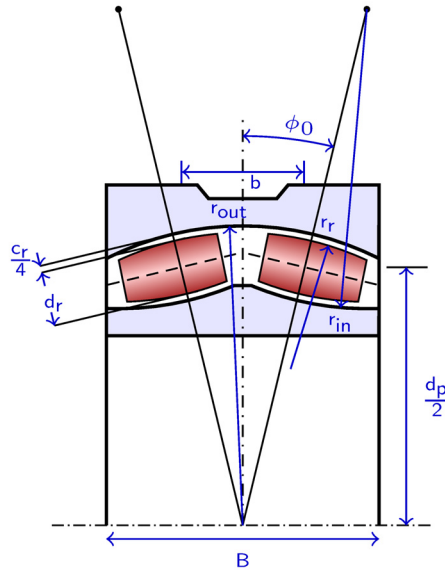

Figure 3-3: Side view of the roller bearing.

Let the relative center displacement between the inner and outer race be \mathbf{u}_r , and the relative tilt about local y and z directions be θ_2 and θ_3 respectively. Then the relative displacement between the inner and outer races at roller i in row j is:

$$\mathbf{u}_j^i = \mathbf{u}_r + (\theta_2 \mathbf{e}_2 + \theta_3 \mathbf{e}_3) \times \mathbf{r}_j^i$$

with

$$\mathbf{r}_j^i = \pm \frac{b}{2} \mathbf{e}_1 + \frac{d_p}{2} \mathbf{e}_{rj}^i$$

for a double row bearing with plus sign for second row and minus sign for the first row, and

$$\mathbf{r}_j^i = \frac{d_p}{2} \mathbf{e}_{rj}^i$$

for single row bearing. Here, b is the axial distance between the roller centers and d_p is the pitch diameter of the bearing. The loaded distance vector between the inner and outer race curvature centers is:

$$\mathbf{A}_j^i = A_0 \mathbf{e}_{j0}^i + \mathbf{u}_j^i$$

The magnitude of the loaded distance vector is the loaded distance between the curvature centers of the races. The distance between the race surfaces along the common normal in the loaded state then can be calculated as:

$$d_j^i = |r_{\text{out}}| + |r_{\text{in}}| - |\mathbf{A}_j^i|$$

Then the indentation at roller i in row j is:

$$\delta_j^i = d_r - d_j^i$$

The total contact force on the inner race is then given by:

$$\mathbf{F}_c = - \sum_{i=1}^N \sum_{j=1}^Z K_c^{\text{tot}} (\delta_j^i)^{3/2} \frac{\mathbf{A}_j^i}{|\mathbf{A}_j^i|}$$

Only positive values of the contact forces on each roller are taken into account, and negative values are replaced by zero since such rollers are unloaded. For a single row bearing, summation over j is dropped. The contact force on the outer race acts in opposite direction to that on inner race.

The net moment on the rotor from the bearing then can be obtained by

$$\mathbf{M}_c = - \sum_{i=1}^N \sum_{j=1}^Z K_c^{\text{tot}} (\delta_j^i)^{3/2} \mathbf{r}_j^i \times \frac{\mathbf{A}_j^i}{|\mathbf{A}_j^i|}$$

CONTACT DEFORMATION IN TAPERED ROLLER BEARING

In the tapered roller bearing the contact force directions at inner and outer contacts are different. In addition, there is also a contact between the bearing flange and roller. Therefore, it is not possible to directly get the equivalent stiffness of the inner and outer contacts. This requires the determination of the contact forces at inner and outer contacts individually. Geometric details of the tapered roller bearing are shown in the Figure 3-4.

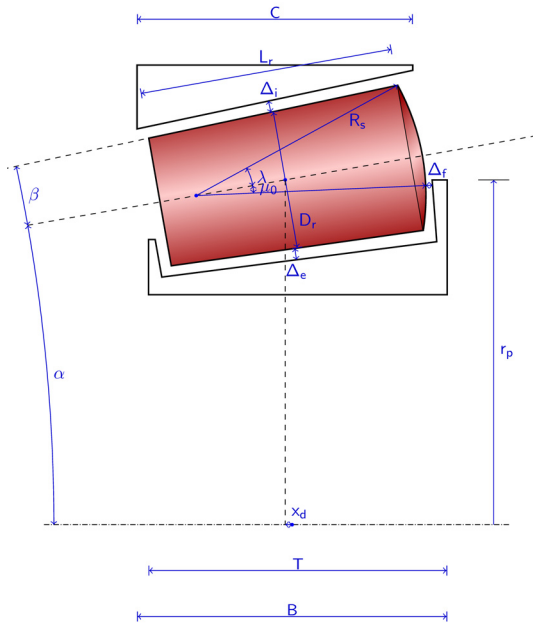

Figure 3-4: Tapered roller bearing geometry

There are three locations at which the roller comes into contact with the inner and outer races, namely radial contact with the outer race, radial contact with the inner race, and axial contact with the inner race. Radial contacts are line contacts, whereas the axial contact between the roller and the inner race is a point contact. In order to

determine the contact forces in all these cases, contact deformation in the roller needs to be determined due to the relative motion of the inner and outer races. This can be described conveniently by using a local coordinate system (ξ, η, ζ) in which the ζ direction is along the axis of the roller, ξ is perpendicular to the ζ axis and is in the plane formed by bearing's radial and axial directions. In this coordinate system, the relative in-plane motion (ξ - ζ plane) and tilt about η axis can cause roller deformation.

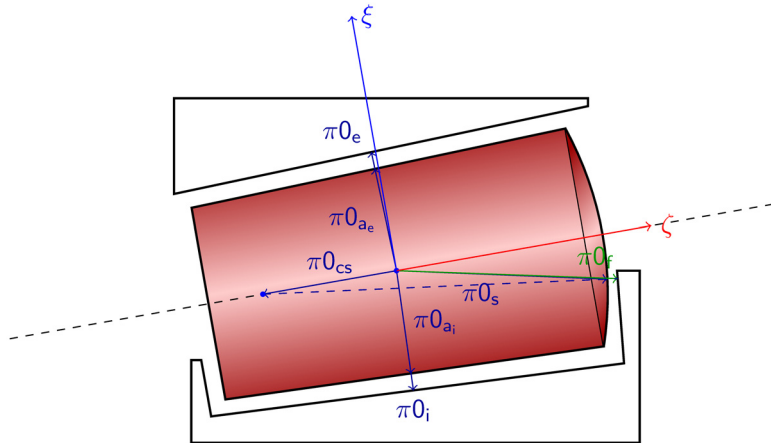

Figure 3-5: Position vectors of the various points in local coordinate system.

Determination of the roller deformation can be done by first looking at the initial position vectors of the various points which are likely to come into contact, and then determine their current position vector due to the motion of the races. A projection of the difference between the current and initial position vectors gives an estimate to the roller deformation. Using the geometric details given in the [Figure 3-4](#), the position vectors of the various points are as follows:

$$\begin{aligned}
\pi_{0ai} &= -\frac{D_a}{2}\mathbf{e}_\xi - \frac{D_a}{2}\tan\beta\mathbf{e}_\zeta \\
\pi_{0i} &= -\left(\frac{D_a}{2} + \Delta_i \cos\beta\right)\mathbf{e}_\xi - \left(\frac{D_a}{2}\tan\beta + \Delta_i \sin\beta\right)\mathbf{e}_\zeta \\
\pi_{0ae} &= \frac{D_a}{2}\mathbf{e}_\xi - \frac{D_a}{2}\tan\beta\mathbf{e}_\zeta \\
\pi_{ae} &= \left(\frac{D_a}{2} + \Delta_e \cos\beta\right)\mathbf{e}_\xi - \left(\frac{D_a}{2}\tan\beta + \Delta_e \sin\beta\right)\mathbf{e}_\zeta \\
\pi_{0cs} &= -\zeta_{cs}\mathbf{e}_\zeta \\
\pi_{0s} &= -R_s \sin\mu_0\mathbf{e}_\xi + (-\zeta_{cs} + R_s \cos\mu_0)\mathbf{e}_\zeta \\
\pi_{0f} &= -(R_s + \Delta_f)\sin\mu_0\mathbf{e}_\xi
\end{aligned}$$

where ζ_{cs} is given by

$$\zeta_{cs} = R_s \cos\lambda - \frac{L_r}{2} \cos\beta + \frac{D_a}{2} \tan\beta$$

Introduce the displacement \mathbf{u}_i and rotation vector θ_i at the reference point on the inner race, the displacement \mathbf{u}_e and rotation vector θ_e at the reference point on the outer race, and the displacement \mathbf{u}_r and rotation vector θ_r at the reference point on the rollers. Then, the displaced position π of the arbitrary point located at π_0 from the reference point will be:

$$\pi = \pi_0 + \mathbf{u}_{\text{ref}} + \theta_{\text{ref}} \times \pi_0$$

where \mathbf{u}_{ref} and θ_{ref} are pair (\mathbf{u}_i, θ_i) for a point on the inner race, (\mathbf{u}_e, θ_e) for a point on the outer race and (\mathbf{u}_r, θ_r) for a point on the roller.

The compression δ at the contact between roller and raceway is found by taking the projection of the current relative position vectors of the nominal contact points on their outside normal vector and removing the initial gap:

$$\begin{aligned}
\delta_i &= -[(\pi_i - \pi_{ai}) - (\pi_{0i} - \pi_{0ai})] \cdot \mathbf{n}_i \\
\delta_e &= -[(\pi_e - \pi_{ae}) - (\pi_{0e} - \pi_{0ae})] \cdot \mathbf{n}_e \\
\delta_f &= -[(\pi_f - \pi_s) - (\pi_{0f} - \pi_{0s})] \cdot \mathbf{n}_f
\end{aligned}$$

The normal vectors in the local coordinate system are given by:

$$\begin{aligned}\mathbf{n}_i &= -\cos\beta\mathbf{e}_\xi - \sin\beta\mathbf{e}_\zeta \\ \mathbf{n}_e &= \cos\beta\mathbf{e}_\xi - \sin\beta\mathbf{e}_\zeta \\ \mathbf{n}_f &= -\sin\mu_0\mathbf{e}_\xi + \cos\mu_0\mathbf{e}_\zeta\end{aligned}$$

After simplification, the respective indentations are:

$$\begin{aligned}\delta_i &= -(\mathbf{u}_i - \mathbf{u}_r) \cdot \mathbf{n}_i - \Delta_i \\ \delta_e &= -(\mathbf{u}_e - \mathbf{u}_r) \cdot \mathbf{n}_e - \Delta_e \\ \delta_f &= -(\mathbf{u}_i - \mathbf{u}_r) \cdot \mathbf{n}_f - \Delta_f - \zeta_{cs}(\theta_i - \theta_r)\sin\mu_0\end{aligned}$$

In this case, the roller center is chosen as the reference point for both the roller and the races.

The motion of the both the races are determined from the motion of the components they are connected to. For example, the inner race motion can be determined from the rotor and the outer race motion can be determined from the motion of the bearing pedestal. The motion of the roller, however, still remains unknown. It can be determined by considering the load balance of the roller as shown in [Figure 3-6](#).

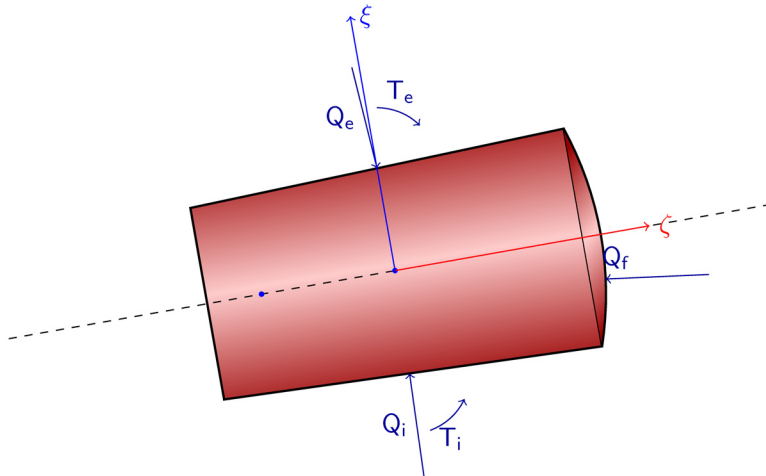

Figure 3-6: Load balance on the roller

Force balance:

$$-(Q_i \mathbf{n}_i + Q_e \mathbf{n}_e + Q_f \mathbf{n}_f) = 0$$

Moment balance:

$$-(Q_i \mathbf{n}_i \times \pi_{0ai} + Q_e \mathbf{n}_e \times \pi_{0ae} + Q_f \mathbf{n}_f \times \pi_{0s} + T_e \mathbf{e}_\eta - T_i \mathbf{e}_\eta) = 0$$

In the local roller direction, this reduces to:

$$\begin{aligned} -Q_e \cos \beta + Q_i \cos \beta + Q_f \sin \mu_0 &= 0 \\ Q_e \sin \beta + Q_i \sin \beta - Q_f \cos \mu_0 &= 0 \\ T_i - T_e - Q_f \zeta_{cs} \sin \mu_0 &= 0 \end{aligned}$$

The contact forces, in terms of roller deformation are:

$$\begin{aligned} Q_e &= K_e (\delta_e)^{10/9} \\ Q_i &= K_i (\delta_i)^{10/9} \\ Q_f &= K_f (\delta_f)^{3/2} \end{aligned}$$

The corresponding contact moments from line contact are obtained by integrating the local contact forces over the contact line:

$$\begin{aligned} \mathbf{T}_e &= \int_{-L_r/2}^{L_r/2} \mathbf{r}_e \times (-dQ_e \mathbf{n}_e) \\ \mathbf{T}_i &= \int_{-L_r/2}^{L_r/2} \mathbf{r}_i \times (-dQ_i \mathbf{n}_i) \end{aligned}$$

where \mathbf{r}_e and \mathbf{r}_i are the position vectors on the outer and inner contact lines, respectively, with respect to the reference point. dQ_e and dQ_i are the infinitesimal forces acting on the infinitesimal length dx on the outer and inner contact lines.

Contact forces and moments then need to be added from each roller to determine the total bearing forces acting on the rotor and bearing pedestal.

CONTACT DEFORMATION IN CYLINDRICAL ROLLER BEARING

In the cylindrical roller bearing, the forces at inner and outer contact lines are aligned as in the case of the point contact roller bearings. A typical arrangement of a cylindrical

roller bearing is shown in Figure 3-7. The initial gap between the outer race and inner race for roller i in row j is given by:

$$d_0 = d_r + \frac{c_r}{2}$$

along the line

$$\mathbf{e}_{j0}^i = \mathbf{e}_{rj}^i$$

Here, \mathbf{e}_{rj}^i is the radial vector corresponding to the roller i in row j and is defined as:

$$\mathbf{e}_{rj}^i = \cos \beta_j^i \mathbf{e}_2 + \sin \beta_j^i \mathbf{e}_3$$

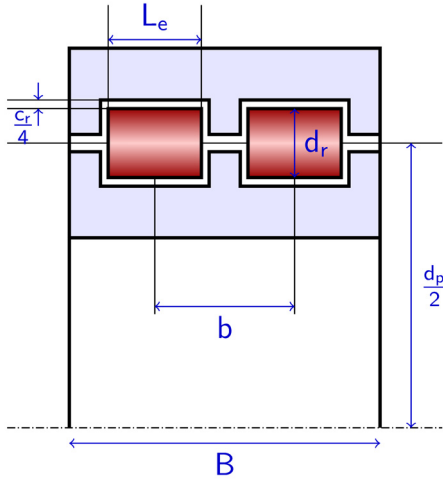

Figure 3-7: Geometry of the cylindrical roller bearing.

Let the relative center displacement of the inner race with respect to outer race be \mathbf{u}_r and the relative tilt about local y and z directions be θ_2 and θ_3 , respectively. Then the relative displacement of the inner with respect to outer races at roller i in row j is:

$$\mathbf{u}_j^i = \mathbf{u}_r + (\theta_2 \mathbf{e}_2 + \theta_3 \mathbf{e}_3) \times \mathbf{r}_j^i$$

with

$$\mathbf{r}_j^i = \pm \frac{b}{2} \mathbf{e}_1 + \frac{d_p}{2} \mathbf{e}_{rj}^i$$

for a double row bearing. Plus sign applies to the second row and minus sign to the first row and

$$\mathbf{r}_j^i = \frac{d_p}{2} \mathbf{e}_{rj}^i$$

for a single row bearing. b is the axial distance between the roller centers and d_p is the pitch diameter of the bearing.

After the loading, the gap vector of the outer race with respect to the inner race is:

$$\mathbf{d}_j^i = d_0 \mathbf{e}_{j0}^i - \mathbf{u}_j^i$$

Then the indentation at roller i in row j is:

$$\delta_j^i = d_r - (\mathbf{d}_j^i \cdot \mathbf{e}_{rj}^i) = \mathbf{u}_j^i \cdot \mathbf{e}_{rj}^i - \frac{c_r}{2}$$

The total contact force on the inner race is then given by:

$$\mathbf{F}_c = - \sum_{i=1}^{IV} \sum_{j=1}^Z K_c^{\text{tot}} (\delta_j^i)^{3/2} \mathbf{e}_{rj}^i$$

Only positive values of the contact forces on each roller are taken into account, and negative values are replaced by zero since the roller is unloaded. For a single row bearing, summation over j is dropped. Contact forces on the outer race acts in the opposite direction to those at the inner race.

The net moment on the rotor due to bearing then can be obtained by

$$\mathbf{M}_c = - \sum_{i=1}^{IV} \sum_{j=1}^Z K_c^{\text{tot}} (\delta_j^i)^{3/2} \mathbf{r}_j^i \times \mathbf{e}_{rj}^i$$

Fixed Foundation

The purpose of the Fixed Foundation is to approximately model a case in which the foundation is very stiff as compared to the rotor itself. Therefore, the foundation is assumed to be static in this case and

$$\begin{aligned}\mathbf{u}_f &= \mathbf{0} \\ \theta_f &= \mathbf{0}\end{aligned}$$

Moving Foundation

The purpose of the **Moving Foundation** node is to model a ground vibration effect on the rotor. Here, the motion of the foundation \mathbf{u}_f and θ_f is already known, either through some experimental observation or through simulation. The linearized displacement field of the foundation is given by

$$\mathbf{u}_{fd} = \mathbf{u}_f + \theta_f \times (\mathbf{X} - \mathbf{X}_c)$$

Note that this does not affect the eigenfrequencies of the rotordynamic system.

Flexible Foundation

The purpose of the **Flexible Foundation** node is to model the effect of the flexibility of the foundation on which the bearing is mounted. In this case, the motion of the foundation is not known *a priori*, rather it is solved for. Here, the inputs are the stiffnesses, k_u and k_θ , and the damping constants, c_u and c_θ . If the coupling between the foundation's translational and rotational motion is considered, the inputs $k_{u\theta}$, $k_{\theta u}$, $c_{u\theta}$, and $c_{\theta u}$ are also needed. The contribution to the virtual work is:

$$\begin{aligned}\delta W = & -\frac{1}{A} \int_A \left(\left(k_u \mathbf{u}_f + k_{u\theta} \theta_f + c_u \frac{\partial \mathbf{u}_f}{\partial t} + c_{u\theta} \frac{\partial \theta_f}{\partial t} \right) \cdot \delta \mathbf{u}_f + \right. \\ & \left. \left(k_\theta \theta_f + k_{\theta u} \mathbf{u}_f + c_\theta \frac{\partial \theta_f}{\partial t} + c_{\theta u} \frac{\partial \mathbf{u}_f}{\partial t} \right) \cdot \delta \theta_f \right) dA\end{aligned}$$

The displacement field of the foundation is given by

$$\mathbf{u}_{fd} = \mathbf{u}_f + \theta_f \times (\mathbf{X} - \mathbf{X}_c)$$

Note that in this case, the foundation properties affect the natural frequencies of the rotor system.

Squeeze Film Damper

The purpose of the **Squeeze Film Damper** node is to model the additional damping provided to the bearing through a squeezing action in the fluid film. Damping is modeled in terms of effective damping coefficients based on the analytical solution of the Reynolds equation in the film for a short length approximation. These coefficients are functions of damper dimensions, lubricant properties and the location of the journal in the damper as given below:

$$c_{22} = \mu R \left(\frac{L}{C}\right)^3 \left[\frac{\pi(1+2\varepsilon^2)}{2(1-\varepsilon^2)^{5/2}} \left(\frac{u_2}{e}\right)^2 + \frac{4\varepsilon}{(1-\varepsilon^2)^2} \left(\frac{u_2}{e}\right) \left(\frac{u_3}{e}\right) + \frac{\pi}{2(1-\varepsilon^2)^{3/2}} \left(\frac{u_3}{e}\right)^2 \right]$$

$$c_{23} = \mu R \left(\frac{L}{C}\right)^3 \left[\frac{2\varepsilon}{(1-\varepsilon^2)^2} \left\{ \left(\frac{u_3}{e}\right)^2 - \left(\frac{u_2}{e}\right)^2 \right\} + \frac{3\pi\varepsilon^2}{2(1-\varepsilon^2)^{5/2}} \left(\frac{u_2}{e}\right) \left(\frac{u_3}{e}\right) \right]$$

$$c_{32} = c_{23}$$

$$c_{33} = \mu R \left(\frac{L}{C}\right)^3 \left[\frac{\pi}{2(1-\varepsilon^2)^{3/2}} \left(\frac{u_2}{e}\right)^2 - \frac{4\varepsilon}{(1-\varepsilon^2)^2} \left(\frac{u_2}{e}\right) \left(\frac{u_3}{e}\right) + \frac{\pi(1+2\varepsilon^2)}{2(1-\varepsilon^2)^{5/2}} \left(\frac{u_3}{e}\right)^2 \right]$$

Here, μ is the viscosity of the lubricant, R is the radius of the journal, L is the length of the journal and C is the clearance between the journal and damper when the journal is concentric with the damper. Subscripts 2 and 3 refer to local y and z directions, respectively. u_2 and u_3 are the journal displacements in the local y and z directions, respectively. $e = \sqrt{\frac{u_2^2}{2} + \frac{u_3^2}{2}}$ is the eccentricity of the journal in the damper. ε is the relative eccentricity with respect to the initial clearance between the journal and the damper, $\varepsilon = e/C$.

The components of the damper force on the journal in local directions is given by

$$\begin{bmatrix} F_2 \\ F_3 \end{bmatrix} = - \begin{bmatrix} c_{22} & c_{23} \\ c_{32} & c_{33} \end{bmatrix} \begin{bmatrix} \dot{u}_2 \\ \dot{u}_3 \end{bmatrix}$$

The damping coefficients given above will however become singular when the journal center coincides with damper center since e appears in the denominator of several expressions. The limiting values are:

$$c_{22} = c_{33} = \mu R \left(\frac{L}{C} \right)^3 \frac{\pi}{2}$$

$$c_{23} = c_{32} = 0$$

To avoid the singularity, these values are used while performing eigenfrequency and frequency domain analyses.

References

1. W. J. Chen, and E.J. Gunter, *Introduction to Dynamics of Rotor-Bearing Systems*, Trafford Publishing, 2007.
2. J. S. Rao, *Rotor Dynamics*, New Age International Publishers, 2014.

Multi-Spool Bearing

Multi-spool bearings are intershaft bearings connecting coaxial rotors running at different speeds.

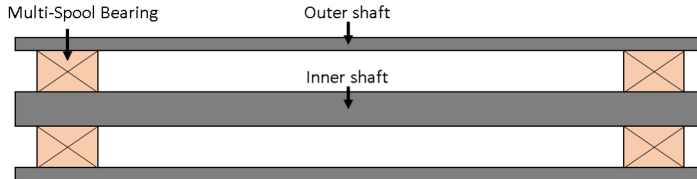

Figure 3-8: Multi-spool bearing

A connection between the rotors is established by adding a spring-damper system with equivalent stiffness and damping coefficients between the corresponding surfaces on both the shafts. Usually the radial deformation in the shafts is not significant when compared to the overall lateral displacement. Therefore, only average lateral displacements and average tilting rotations in local directions are used for formulating the connection.

Displacement and Rotations in Solid Rotor

Bearing coefficients are specified in space fixed directions, which are local to the bearing. Because the Solid Rotor interface is formulated in a co-rotating frame, the displacements are observed from a rotating frame. This displacement field should be transformed to a space fixed frame before evaluating the average displacement and tilting of the connected boundaries. Let $\mathbf{u}_{1,r}$ and $\mathbf{u}_{2,r}$ be the displacement fields of the rotors in their respective co-rotating frames. The space fixed displacement field can be obtained as:

$$\mathbf{u}_1 = R(\theta_1)\mathbf{u}_{1,r}$$

$$\mathbf{u}_2 = R(\theta_2)\mathbf{u}_{2,r}$$

where R is the rotation matrix corresponding to the axial rotation and θ_1 and θ_2 are the corresponding axial rotations of the rotor.

Average displacement and rotations of the connected surface can be obtained as:

$$\mathbf{u}_c = \frac{\int_{\partial\Omega} \mathbf{u} dS}{\int_{\partial\Omega} dS}$$

$$\theta_c = \frac{\int_{\partial\Omega} (\mathbf{r} - \mathbf{r}_c) \times (\mathbf{u} - \mathbf{u}_c) dS}{\int_{\partial\Omega} (\mathbf{r} - \mathbf{r}_c) \cdot (\mathbf{r} - \mathbf{r}_c) dS}$$

where \mathbf{r}_c is the center of the connected boundaries and

$$\mathbf{r} - \mathbf{r}_c = R(\Omega)(\mathbf{X} - \mathbf{X}_c)$$



The Beam Rotor interface is modeled in a space fixed frame. Therefore, there is no need to do any transformation to get the displacement in space fixed frame. Also, both displacements and rotations are degrees of freedom in the Beam Rotor interface. These are directly used for connecting the respective points.

Intershaft Connection

Connections can be either rigid or flexible. The rigid case is an idealized model where the bearing stiffness is much larger than the stiffness of the connected shafts. In the flexible case, the displacements and rotations of both shafts are connected through an equivalent spring and damper.

RIGID CONNECTION

For a rigid connection, a constraint is added to make the lateral displacement and tilting rotations of the both shafts equal. In the presence of misalignment in the bearing, these constraints should accommodate the misalignment too.

$$u_{2,1} = u_{2,2} + u_{2,0}$$

$$u_{3,1} = u_{3,2} + u_{3,0}$$

$$\theta_{2,1} = \theta_{2,2} + \theta_{2,0}$$

$$\theta_{3,1} = \theta_{3,2} + \theta_{3,0}$$

The first subscript refers to the local y or z components, and the second subscript refers to shafts or misalignment. 1 and 2 refers to the shafts and 0 refers to the misalignment.

FLEXIBLE CONNECTION

For the flexible case, spring-damper forces and moments proportional to the corresponding relative motion between the shaft are added:

$$\begin{Bmatrix} F_2 \\ F_3 \end{Bmatrix} = - \begin{bmatrix} k_{u,22} & k_{u,23} \\ k_{u,32} & k_{u,33} \end{bmatrix} \begin{Bmatrix} u_{2,12} \\ u_{3,12} \end{Bmatrix} - \begin{bmatrix} c_{u,22} & c_{u,23} \\ c_{u,32} & c_{u,33} \end{bmatrix} \begin{Bmatrix} \dot{u}_{2,12} \\ \dot{u}_{3,12} \end{Bmatrix}$$

and

$$\begin{Bmatrix} M_2 \\ M_3 \end{Bmatrix} = - \begin{bmatrix} k_{\theta,22} & k_{\theta,23} \\ k_{\theta,32} & k_{\theta,33} \end{bmatrix} \begin{Bmatrix} \theta_{2,12} \\ \theta_{3,12} \end{Bmatrix} - \begin{bmatrix} c_{\theta,22} & c_{\theta,23} \\ c_{\theta,32} & c_{\theta,33} \end{bmatrix} \begin{Bmatrix} \dot{\theta}_{2,12} \\ \dot{\theta}_{3,12} \end{Bmatrix}$$

Here

$$\begin{aligned} u_{2,12} &= u_{2,1} - u_{2,2} - u_{2,0} \\ u_{3,12} &= u_{3,1} - u_{3,2} - u_{3,0} \\ \theta_{2,12} &= \theta_{2,1} - \theta_{2,2} - \theta_{2,0} \\ \theta_{3,12} &= \theta_{3,1} - \theta_{3,2} - \theta_{3,0} \end{aligned}$$



Misalignment values can be specified in the **Misalignment** node under **Multi-Spool Bearing**.

Rotor Coupling

Coupling members are used for connecting rotors in long rotor assemblies. One such example is a *spline coupling*. This coupling connects the displacements of the rotors while providing the freedom to tilt relative to each other. Another example is a *torsional coupling* where the coupling has certain stiffness for the relative axial rotation of the connected rotors while keeping the displacement and tilting of the rotors rigidly connected. In general, a coupling will have some combination of allowed and restricted relative motions across the two rotors. Connection between the different degrees of freedom for various types of couplings are described in the following sections.

Spline Coupling

In a spline coupling, displacements and axial rotation of the rotors are rigidly connected whereas rotors are free to tilt relative to each other.

If a **Rotor Coupling** is applied to an interior boundary, the degrees of freedom in the rotor are split and then connected using the following constraint:

$$\begin{aligned}\mathbf{u}_u &= \mathbf{u}_d + \mathbf{u}_0 \\ \theta_{1u} &= \theta_{1d}\end{aligned}$$

Here, \mathbf{u}_u and \mathbf{u}_d are the displacements on both sides of the interior boundary. \mathbf{u}_0 is the parallel misalignment in the coupling. θ_{1u} and θ_{1d} are the axial rotations of the rotors on both sides of the interior boundary.

On an exterior boundary, there is no rotor present on the other side. Therefore, displacement and tilt rotations are free for this coupling type, while the axial rotation is fixed:

$$\theta_1 = 0$$

Here, θ_1 is the axial rotation of the rotor on the selected boundary.

Torsional Coupling

A torsional coupling offers a torsional stiffness between the two rotors. Other degrees of freedom — displacement and tilting rotations — of both rotors are rigidly

connected. On an interior boundary, the following constraints and torsional moments are applied:

$$\begin{aligned}\mathbf{u}_u &= \mathbf{u}_d + \mathbf{u}_0 \\ \theta_{2u} &= \theta_{2d} + \theta_{0y} \\ \theta_{3u} &= \theta_{3d} + \theta_{0z} \\ \Delta T_1 &= -k_{\theta, ax}(\theta_{1u} - \theta_{1d})\end{aligned}$$

Here, θ_{2u} and θ_{3u} are the bending rotations on one side of the interior boundary and θ_{2d} and θ_{3d} are the rotations on the other side. Subscripts 2 and 3 denote the local y and z direction components of the bending rotation. θ_{0y} and θ_{0z} are the angular misalignment values in the local y and z directions, respectively.

On an exterior boundary, displacements and tilt rotations are free. A torsional moment given by

$$T_1 = -k_{\theta, ax}\theta_1$$

acts on this boundary.

User Defined

A general connection between the two rotors can be established using the **User defined** option. The degrees of freedom are split into three types: displacement, bending rotation, and axial rotation. Each type of degree of freedom can be rigidly or flexibly connected. In the rigid case, a constraint is applied across the degrees of freedom on both rotors. In the flexible case, a force (moment) proportional to the degree of freedom is applied. The following sections describe the corresponding constraints and forces (moments) for various types of connections.

DISPLACEMENT CONNECTION

For a rigid connection, the following constraints are applied on the interior boundary:

$$\mathbf{u}_u = \mathbf{u}_d + \mathbf{u}_0$$

On the exterior boundary, the constraint is:

$$\mathbf{u} = \mathbf{u}_0$$

If the connection is flexible, the force acts on the relative translation of the two rotors on the interior boundary:

$$\Delta \mathbf{F} = -k_u(\mathbf{u}_u - \mathbf{u}_d - \mathbf{u}_0)$$

Note that the relative motion is offset by the misalignment value, if any. Thus, the misalignment acts like a predeformation in the spring.

On an exterior boundary, the force is given by

$$\mathbf{F} = -k_u(\mathbf{u} - \mathbf{u}_0)$$

AXIAL ROTATION CONNECTION

On an interior boundary, the following constraints are applied for a rigid case:

$$\theta_{1u} = \theta_{1d}$$

On an exterior boundary, the constraint changes to

$$\theta_1 = 0$$

For a flexible connection on the interior boundary, the following torsional moment is applied on the relative axial rotation:

$$\Delta T_1 = -k_{\theta, ax}(\theta_{1u} - \theta_{1d})$$

On an exterior boundary it is

$$T_1 = -k_{\theta, ax}\theta_1$$

BENDING ROTATION CONNECTION

For a rigid connection, the following constraints are applied on an interior boundary:

$$\theta_{2u} = \theta_{2d} - \theta_{0y}$$

$$\theta_{3u} = \theta_{3d} - \theta_{0z}$$

On an exterior boundary, the constraints are changed to

$$\theta_2 = \theta_{0y}$$

$$\theta_3 = \theta_{0z}$$

In the case of a flexible connection, the following moments act on an interior boundary on the relative tilting motion of the two rotors:

$$\begin{bmatrix} \Delta M_{b2} \\ \Delta M_{b3} \end{bmatrix} = - \begin{bmatrix} k_{\theta 22} & k_{\theta 23} \\ k_{\theta 32} & k_{\theta 33} \end{bmatrix} \begin{bmatrix} \theta_{2u} - \theta_{2d} - \theta_{0y} \\ \theta_{3u} - \theta_{3d} - \theta_{0z} \end{bmatrix}$$

On an exterior boundary, the moments are

$$\begin{bmatrix} M_{b2} \\ M_{b3} \end{bmatrix} = - \begin{bmatrix} k_{\theta 22} & k_{\theta 23} \\ k_{\theta 32} & k_{\theta 33} \end{bmatrix} \begin{bmatrix} \theta_2 \\ \theta_3 \end{bmatrix}.$$



Misalignment values can be specified from the **Misalignment** feature, available as a subnode for **Rotor Coupling**.

Misalignment

Misalignment in the bearings and rotor couplings can occur due as an effect of improper mounting. Misalignment often results in metal to metal contact in the bearing components with high contact forces. This gives rise to noise and high temperatures in the bearing. The misalignment is broadly classified in the following categories:

- Parallel misalignment: The axes of the bearings are parallel to each other but the bearing centers are offset in the lateral direction (see [Figure 3-9](#)).
- Angular misalignment: The axes of the bearings are not perfectly parallel. Rather, they are slightly inclined relative to each other (see [Figure 3-10](#)). Bearing centers are still aligned in the direction of the rotor axis.
- A combination of the above two.

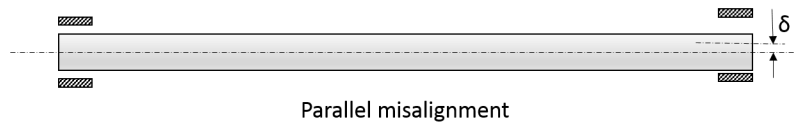

Figure 3-9: Parallel misalignment

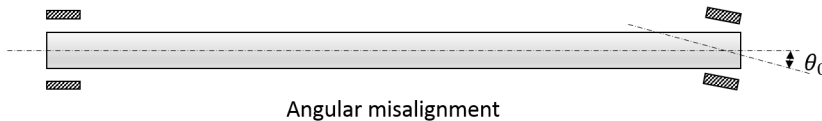

Figure 3-10: Angular misalignment

Misalignment modeling for the different types of bearings is explained in the following sections.

Journal and Thrust Bearings

Misalignment in journal and thrust bearings acts as preload on the rotor and has a similar effect as predeformation in springs. Therefore, modeling of the misalignment requires adjustment of the relative motion between the journal and the foundation

motion. Let \mathbf{u}_r and \mathbf{u}_f be the journal and foundation displacements at the bearing center, and θ_r and θ_f be the tilt angles of the rotor and foundation. For a parallel misalignment \mathbf{u}_0 , the relative displacement between the journal and foundation is given by

$$\Delta \mathbf{u} = \mathbf{u}_r - \mathbf{u}_f - \mathbf{u}_0$$

For an angular misalignment θ_0 , the relative angular displacement between the journal and foundation is

$$\Delta \theta = \theta_r - \theta_f - \theta_0$$

The spring and damping forces are then functions of these relative displacements, rotations and their derivatives.



For details about the bearing forces, see the theory for the [Journal Bearing](#) and [Thrust Bearing](#).

Radial Roller Bearing

The roller deformation in the roller bearings is determined by the relative motion of the shaft and the outer races at the roller location. When the bearing has misalignment, this relative motion needs to be adjusted for the parallel misalignment \mathbf{u}_0 and angular misalignment θ_0 to calculate the actual roller deformation. Let the displacement of the inner race at its center be \mathbf{u}_i and its tilt θ_i , and the displacement of the outer race at its center be \mathbf{u}_o with tilt θ_o . Then, the net relative motion of the inner and outer races including the effect of misalignment can be written as:

$$\Delta \mathbf{u} = (\mathbf{u}_i - \mathbf{u}_o - \mathbf{u}_0) + (\theta_i - \theta_o - \theta_0) \times \mathbf{r}_{rc}$$

Here, \mathbf{r}_{rc} is the position of the roller center relative to the center of the bearing. The roller force is a function of the roller deformation, which in case of misalignment is given by the above expression.



For details about the roller deformation and roller force computation, see the theory for the [Radial Roller Bearing](#).

Rotor Coupling

The behavior of the misalignment in the rotor coupling is similar to that described for the [Journal and Thrust Bearings](#) above. As opposed to the bearings where the relative motion is between the journal (collar) and the foundation, the relative motion is between the two rotors in this case.



For details about the coupling forces and moments, see the theory for the [Rotor Coupling](#).

Multi-Spool Bearing

Misalignment in multi-spool bearings acts as a preload between the rotors and has a similar effect as predeformation in springs. Therefore, modeling misalignment requires adjustment of the relative motion between the shafts. Let \mathbf{u}_1 and \mathbf{u}_2 be the displacements of the shafts at the bearing center, and θ_1 and θ_2 be the corresponding tilt angles. For a parallel misalignment \mathbf{u}_0 , the relative displacement between the shafts is given by

$$\Delta \mathbf{u} = \mathbf{u}_1 - \mathbf{u}_2 - \mathbf{u}_0$$

For an angular misalignment θ_0 , the relative angular displacement between the shafts is

$$\Delta \theta = \theta_1 - \theta_2 - \theta_0$$

The spring and damping forces are then functions of these relative displacements, rotations and their derivatives.



For details about the forces and moments, see the theory for the [Multi-Spool Bearing](#).

Identification of Whirl

When the deformation of the rotor is observed in a corotating frame, the computed eigenfrequencies must be shifted to obtain the correct eigenfrequency from the analysis. This can be shown with the following consideration. Let u_{2r} and u_{3r} be the components of the displacement vector in lateral directions 2 and 3 of the rotor. The axis of the rotor is chosen as direction 1. Then, the harmonic response of these displacements can be represented as

$$u_{2r} = u_{2r}^c \cos \omega t + u_{2r}^s \sin \omega t$$

$$u_{3r} = u_{3r}^c \cos \omega t + u_{3r}^s \sin \omega t$$

The components of the displacements observed in the spatial frame can be written as

$$\begin{bmatrix} u_2 \\ u_3 \end{bmatrix} = \begin{bmatrix} \cos \Omega t & -\sin \Omega t \\ \sin \Omega t & \cos \Omega t \end{bmatrix} \begin{bmatrix} u_{2r} \\ u_{3r} \end{bmatrix}$$

where Ω is the angular velocity of the rotor. After simplification, these components are

$$u_2 = \frac{u_{2r}^c + u_{3r}^s}{2} \cos(\Omega + \omega)t + \frac{u_{2r}^c - u_{3r}^s}{2} \cos(\Omega - \omega)t +$$

$$\frac{u_{2r}^s - u_{3r}^c}{2} \sin(\Omega + \omega)t - \frac{u_{2r}^s + u_{3r}^c}{2} \sin(\Omega - \omega)t$$

and

$$u_3 = \frac{u_{3r}^c - u_{2r}^s}{2} \cos(\Omega + \omega)t + \frac{u_{2r}^s + u_{3r}^c}{2} \cos(\Omega - \omega)t +$$

$$\frac{u_{2r}^c + u_{3r}^s}{2} \sin(\Omega + \omega)t + \frac{u_{2r}^c - u_{3r}^s}{2} \sin(\Omega - \omega)t$$

In the complex plane, the lateral displacement can be represented as $u_1 = u_2 + iu_3$. After substitution, this becomes

$$\begin{aligned}
u_1 = & \frac{1}{2} \{ (u_{2r}^c + u_{3r}^s) + i(u_{3r}^c - u_{2r}^s) \} e^{i(\Omega + \omega)t} + \\
& \frac{1}{2} \{ (u_{2r}^c - u_{3r}^s) + i(u_{3r}^c + u_{2r}^s) \} e^{i(\Omega - \omega)t}
\end{aligned} \tag{3-13}$$

The motion is defined as forward whirl if it whirls in the rotor spinning direction, and as backward whirl if it whirls opposite to the rotor spinning direction. Therefore, the first term in Equation 3-13 corresponds to the forward whirl and the second term corresponds to the backward whirl. The lateral displacement can then be represented in terms of forward and backward components in the following way:

$$u_1 = u_f e^{i(\Omega + \omega)t} + u_b e^{i(\Omega - \omega)t}$$

with

$$\begin{aligned}
u_f &= \frac{1}{2} \{ (u_{2r}^c + u_{3r}^s) + i(u_{3r}^c - u_{2r}^s) \} \\
u_b &= \frac{1}{2} \{ (u_{2r}^c - u_{3r}^s) + i(u_{3r}^c + u_{2r}^s) \}
\end{aligned}$$

A solution from an eigenfrequency analysis is represented as

$$u = (u_R + iu_I) e^{i\omega t}$$

The real part is then

$$\Re(u) = u_R \cos \omega t - u_I \sin \omega t$$

Therefore,

$$\begin{aligned}
u^c &= u_R \\
u^s &= -u_I
\end{aligned}$$

Hence, the forward and backward components can be expressed as

$$\begin{aligned}
u_f &= \frac{1}{2} \{ (u_{2r,R} - u_{3r,I}) + i(u_{3r,R} + u_{2r,I}) \} \\
u_b &= \frac{1}{2} \{ (u_{2r,R} + u_{3r,I}) + i(u_{3r,R} - u_{2r,I}) \}
\end{aligned}$$

The lateral displacement in the complex plane can also be written as

$$u_1 = |u_f|e^{\{i(\Omega + \omega)t + \phi_f\}} + |u_b|e^{\{i(\Omega - \omega)t + \phi_b\}} \quad (3-14)$$

with

$$\begin{aligned} |u_f| &= \frac{1}{2}\sqrt{(u_{2r,R} - u_{3r,I})^2 + (u_{3r,R} + u_{2r,I})^2} \\ |u_b| &= \frac{1}{2}\sqrt{(u_{2r,R} + u_{3r,I})^2 + (u_{3r,R} - u_{2r,I})^2} \\ \phi_f &= \text{atan}\left(\frac{u_{3r,R} + u_{2r,I}}{u_{2r,R} - u_{3r,I}}\right) \\ \phi_b &= \text{atan}\left(\frac{u_{3r,R} - u_{2r,I}}{u_{2r,R} + u_{3r,I}}\right) \end{aligned}$$

Equation 3-14 shows that the orbit of the rotor consists of the summation of two rotating vectors: one is a forward circular motion with an amplitude $|u_f|$, and the other is a backward circular motion with an amplitude $|u_b|$. When the forward amplitude is greater than the backward amplitude, the overall motion is forward. When the forward amplitude is smaller than the backward amplitude, the overall motion is backward. When both amplitudes are equal, the motion degenerates to a straight line. To summarize, you can classify the whirl based on the following criteria:

- $|u_f| = 0$: Backward circular planar motion
- $|u_b| = 0$: Forward circular planar motion
- $|u_b| > |u_f|$: Backward elliptic planar motion
- $|u_b| = |u_f|$: Straight line motion
- $|u_b| < |u_f|$: Forward elliptical planar motion

Quantification of this information can be done conveniently by defining a shape and directivity index in the following way:

$$i_{sd} = \frac{|u_f| - |u_b|}{|u_f| + |u_b|}$$

As a result,

$$-1 \leq i_{sd} \leq 1$$

You can then classify the whirl using the following criteria:

- $i_{sd} = -1$: Backward circular planar motion
- $-1 < i_{sd} < 0$: Backward elliptical planar motion
- $i_{sd} = 0$: Straight line motion
- $0 < i_{sd} < 1$: Forward elliptical planar motion
- $i_{sd} = 1$: Forward circular planar motion

Usually, the entire rotor has either forward or backward whirl. However, it is also possible that the complete rotor can have mixed whirling, meaning the rotor can undergo forward and backward whirl simultaneously at different sections. Mixed whirling sometimes occurs in long flexible rotors supported by fluid film bearings.

References

1. W. J. Chen, and E.J. Gunter, *Introduction to Dynamics of Rotor-Bearing Systems*, Trafford Publishing, 2007.

Added Mass

The [Added Mass](#) node adds the equations for the inertial effects of components that are not explicitly modeled in the rotor system. It is assumed that these components are mounted on the rotor and therefore rotate with it. Inertial properties in the **Added Mass** node are thus assumed to be specified in the rotating frame. Also, the flexibility of these components is much smaller than that in the rotor. Therefore, these components can be treated as rigid bodies. Added mass can exist on domains and boundaries. The inertia force due to added mass in the corotating frame can, by using [Equation 3-4](#), be written as

$$\mathbf{f}_m = -M \cdot \left(R^T \frac{\partial^2 \chi(\mathbf{X}, t)}{\partial t^2} \right) = -M \cdot \mathbf{a}_r$$

where M is the mass distribution matrix. For added mass on a boundary, the contribution to the virtual work is

$$\delta W = \int_A (\mathbf{f}_m \cdot \delta \mathbf{u}_r) dA$$

Energy Quantities

There are several energy quantities computed in the Solid Rotor and Beam Rotor interfaces. This section contains a summary of these quantities and how they are computed in different situations.

Elastic Energy

Elastic energy expressions for the Solid Rotor and Beam Rotor interfaces are similar to the Solid Mechanics and Beam interfaces in the Structural Mechanics Module. For details on the elastic energy, see the *Structural Mechanics Module User's Guide*.

In the Beam Rotor interface, the strain energy density is split into membrane, bending, and shear parts, which are then summed into a total strain energy density.

The strain energy density for all elastic domains is integrated to give a total elastic strain energy, which contains all elastic energy stored in each physics interface.

Kinetic Energy

For a Time Dependent study, kinetic energy is defined as

$$W_k = \frac{1}{2} \rho v^2$$

where ρ is the mass density, and v is the velocity defined as

$$v = \sqrt{\frac{\partial \chi(\mathbf{X}, t)}{\partial t} \cdot \frac{\partial \chi(\mathbf{X}, t)}{\partial t}}$$

Using Equation 3-3, the kinetic energy can be expressed as

$$\begin{aligned} W_k &= \frac{1}{2} \rho \left(\left\{ \Omega_r \times \mathbf{x}_r + \frac{\partial \mathbf{u}_r}{\partial t} \right\} \cdot \left\{ \Omega_r \times \mathbf{x}_r + \frac{\partial \mathbf{u}_r}{\partial t} \right\} \right) = \\ &= \frac{1}{2} \rho \left[(\Omega_r \cdot \Omega_r) (\mathbf{x}_r \cdot \mathbf{x}_r) - (\Omega_r \cdot \mathbf{x}_r)^2 + 2 \left(\frac{\partial \mathbf{u}_r}{\partial t} \cdot \mathbf{x}_r \right) + \frac{\partial \mathbf{u}_r}{\partial t} \cdot \frac{\partial \mathbf{u}_r}{\partial t} \right] \end{aligned}$$

where $\mathbf{x}_r = \mathbf{X} + \mathbf{u}_r - \mathbf{X}_{bp}$.

In frequency domain, the kinetic energy is defined as

$$W_k = \frac{1}{4}\rho[\Omega^2|u_r|^2 - (\Omega_r \cdot \mathbf{u}_r)^2 + \omega^2|u_r|^2]$$

which represents the cycle average.



- [Energy Quantities](#) in the *Structural Mechanics Module Users' Guide*.
-

Gear Theory

In this section:

- [Spur Gear Theory](#)
- [Helical Gear Theory](#)
- [Bevel Gear Theory](#)

Spur Gear Theory

The **Spur Gear** is defined as a rigid body. A finite stiffness for the gear mesh (or gear tooth) can be specified in the **Gear Pair** node while connecting to other gears. Similar to the rigid domain, the spur gear is a material model, which is mutually exclusive to all other material models. The only material property needed is the mass density.

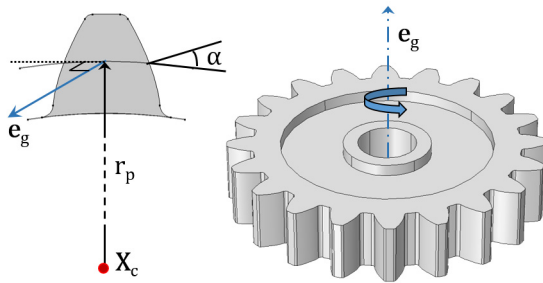

Figure 3-11: Sketch of an external spur gear., showing the tooth cross section and various parameters, such as center of rotation, gear axis, pitch radius, and pressure angle.

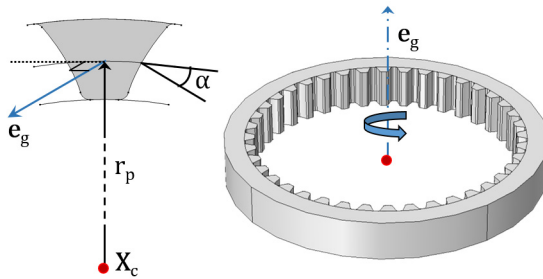

Figure 3-12: ketch of an internal spur gear, showing the tooth cross section and various parameters such as center of rotation, gear axis, pitch radius, and pressure angle.



For details about the theory of a rigid body, see the [Rigid Domain Model](#) section in the *Structural Mechanics Module User's Guide*.

CONNECTION TO OTHER GEARS

A spur gear can be connected to another [Spur Gear](#) or a [Helical Gear](#) through the [Gear Pair](#) node. A single gear can be connected to one or more gears.

MOUNTING METHODS

The motion of a spur gear can be constrained directly using its subnode. Alternatively, it can be mounted on a shaft.

CENTER OF ROTATION

Gears are defined through rigid body degrees of freedom. These degrees of freedom are created at the center of rotation and the rotation is interpreted about this point. By default the center of rotation is set to the center of mass, but there are other ways to define it explicitly. This is the point where you interpret the forces and moment that act on the gear due to meshing with other gears.

GEAR AXIS

The gear axis is the axis of rotation of the gear that passes through the center of rotation. This axis is used to create the gear's local coordinate system in the Gear Pair node. The gear rotation, a degree of freedom in the Gear Pair node, is also interpreted about this axis.

GEAR PROPERTIES

The following quantities are required to define a spur gear:

- Number of teeth (n)
- Pitch diameter (d_p)
- Pressure angle (α)

The transverse module of the gear is defined as:

$$m_t = \frac{d_p}{n}$$

The normal module of the gear is defined as:

$$m_n = m_t$$

Helical Gear Theory

The **Helical Gear** model is defined as a rigid body. A finite stiffness for the gear mesh (or gear tooth) can be specified in the **Gear Pair** node while connecting to other gears. Similar to the rigid domain, the helical gear is a material model, which is mutually exclusive to all other material models. The only material property needed is the mass density.

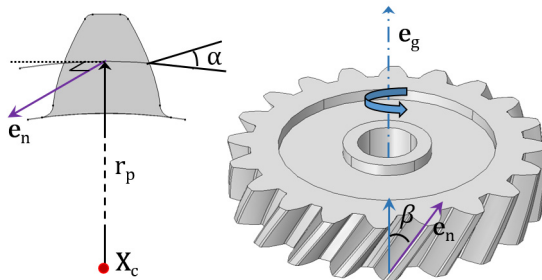

Figure 3-13: Sketch of an external helical gear, showing the tooth cross section and various parameters such as center of rotation, gear axis, pitch radius, pressure angle, and helix angle.

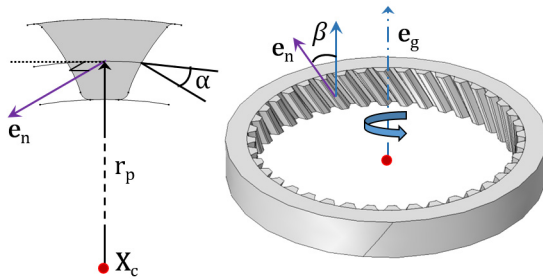

Figure 3-14: Sketch of an internal helical gear, showing the tooth cross section and various parameters such as center of rotation, gear axis, pitch radius, pressure angle, and helix angle.



For details about the theory of a rigid body, see the [Rigid Domain Model](#) section in the *Structural Mechanics Module User's Guide*.



The following section is an addition to the [Spur Gear Theory](#) section, which is also applicable for the helical gear.

GEAR PROPERTIES

The additional parameter helix angle (β) is required to define a helical gear. The positive helix angle is interpreted as right handed and the negative helix angle is interpreted as left handed.

The normal module of the gear is defined as:

$$m_n = m_t \cos \beta$$

Bevel Gear Theory

The [Bevel Gear](#) model is defined as a rigid body. A finite stiffness for the gear mesh (or gear tooth) can be specified in the **Gear Pair** node while connecting to other gears. Similar to the rigid domain, the bevel gear is a material model, which is mutually

exclusive to all other material models. The only material property needed is the mass density.

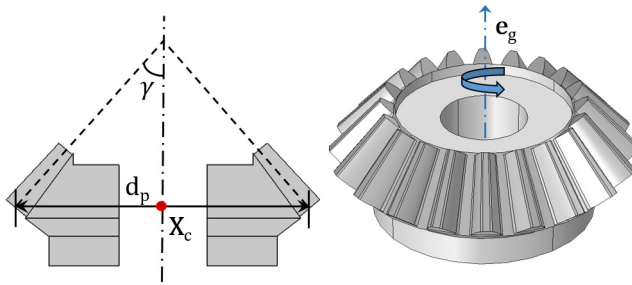

Figure 3-15: Sketch of a bevel gear, showing the gear cross section and various parameters such as center of rotation, gear axis, pitch diameter, and cone angle.



For details about the theory of a rigid body, see the [Rigid Domain Model](#) section in the *Structural Mechanics Module User's Guide*.



The following section is an addition to the [Spur Gear Theory](#) section, some of which is also applicable for the bevel gear.

CONNECTION TO OTHER GEARS

A bevel gear can be connected to another [Bevel Gear](#) through the [Gear Pair](#) node. A single gear can be connected to one or more gears.

GEAR PROPERTIES

The additional parameter cone angle (γ) is required to define a bevel gear. The positive cone angle results in a decrease in diameter along the gear axis.

Gear Pair Theory

In this section:

- Theory for Gear Pairs
- Theory for Gear Elasticity
- Theory for Transmission Error
- Theory for Backlash
- Theory for Gear Friction

Theory for Gear Pairs

The **Gear Pair** node connects two spur gears, helical gears, or bevel gears in such a way that at the contact point, they have no relative motion along the line of action. The remaining displacements and rotations of both gears are independent of each other.

In case of a line contact model, one additional constraint is added to restrict the relative rotation about a line joining the two gear centers. When friction is included for a gear pair, frictional forces in the plane perpendicular to the line of action are added on both the gears.

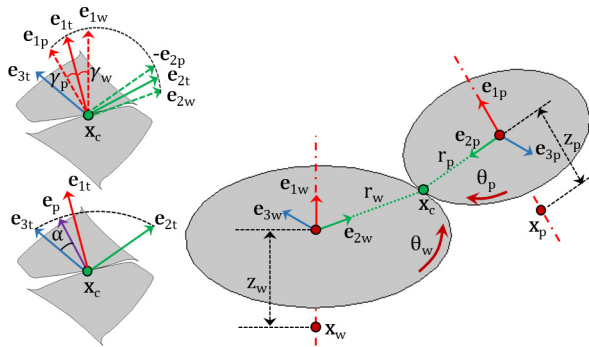

Figure 3-16: Sketch of a gear pair where the line of action is computed by the clockwise rotation of the tangent.

The degrees of freedom at the gear pair are θ_{wh} and θ_{pn} . They are defined as the rotation of the wheel and pinion about the first axis of their respective local coordinate system.

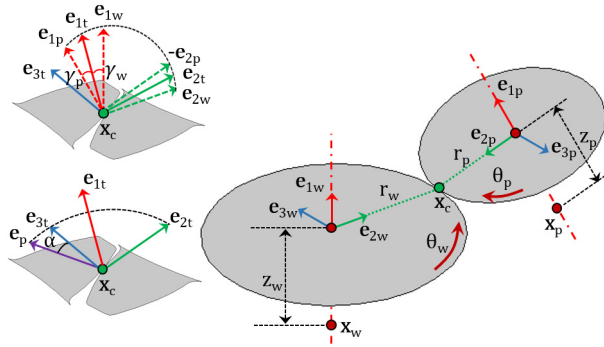

Figure 3-17: Sketch of a gear pair where the line of action is computed by the counterclockwise rotation of the tangent.

The rest of this section discusses the following topics:

- Gear Pair Compatibility Criteria
- Gear Ratio
- Gear Local Coordinate System
- Contact Point Position and Offset
- Gear Tooth Coordinate System
- Gear Pair Constraints
- Line of Action
- Contact Forces and Moments

GEAR PAIR COMPATIBILITY CRITERIA

In a **Gear Pair** node, you can select any two gears defined for the model. However, for the correct tooth meshing, a set of gears must fulfill the compatibility criteria.

Normal Module

The normal module of both gears must be the same.

$$m_{n, wh} = m_{n, pn}$$

Pressure Angle

The pressure angle of both gears must be the same.

$$\alpha_{wh} = \alpha_{pn}$$

Configuration

For parallel axis helical gears, the sum of the helix angles must be zero.

$$\beta_{wh} + \beta_{pn} = 0$$

For crossed axis helical gears, the sum of the helix angle must be nonzero.

$$\beta_{wh} + \beta_{pn} \neq 0$$

GEAR LOCAL COORDINATE SYSTEM

The local coordinate system for each gear is created using the gear axis and the center of rotation of both gears. This local coordinate system is attached to the gear; however, it does not rotate with the gear local rotation.

Initial Local Coordinate System

The first axis for the wheel ($\mathbf{e}_{10, wh}$) and pinion ($\mathbf{e}_{10, pn}$) is an input on the respective nodes. In 2D, it is assumed to be the out-of-plane direction.

For a parallel or intersecting configuration, the second axis is defined as:

$$\begin{aligned}\mathbf{e}_{20, wh} &= \mathbf{e}_{0, cd} - (\mathbf{e}_{0, cd} \cdot \mathbf{e}_{10, wh})\mathbf{e}_{10, wh} \\ \mathbf{e}_{20, pn} &= -(\mathbf{e}_{0, cd} - (\mathbf{e}_{0, cd} \cdot \mathbf{e}_{10, pn})\mathbf{e}_{10, pn})\end{aligned}$$

$$\mathbf{e}_{0, cd} = \frac{\mathbf{x}_{c, pn} - \mathbf{x}_{c, wh}}{\|\mathbf{x}_{c, pn} - \mathbf{x}_{c, wh}\|}$$

where $\mathbf{x}_{c, wh}$ and $\mathbf{x}_{c, pn}$ are the center of rotation of the wheel and pinion, respectively.

For a configuration that is neither parallel nor intersecting, the second axis is defined as:

$$\begin{aligned}\mathbf{e}_{20, wh} &= \mathbf{e}_{20} \operatorname{sgn}(\mathbf{e}_{20} \cdot \mathbf{e}_{0, cd}) \\ \mathbf{e}_{20, pn} &= -\mathbf{e}_{20, wh}\end{aligned}$$

$$\mathbf{e}_{20} = \mathbf{e}_{10, wh} \times \mathbf{e}_{10, pn}$$

In 2D:

$$\begin{aligned}\mathbf{e}_{20, wh} &= \mathbf{e}_{0, cd} \\ \mathbf{e}_{20, pn} &= -\mathbf{e}_{0, cd}\end{aligned}$$

The third axis is defined as follows:

$$\begin{aligned}\mathbf{e}_{30, wh} &= \mathbf{e}_{10, wh} \times \mathbf{e}_{20, wh} \\ \mathbf{e}_{30, pn} &= \mathbf{e}_{10, pn} \times \mathbf{e}_{20, pn}\end{aligned}$$

Local Coordinate System

The first axis is defined as follows:

$$\begin{aligned}\mathbf{e}_{1, wh} &= R_{wh} \cdot \mathbf{e}_{10, wh} \\ \mathbf{e}_{1, pn} &= R_{pn} \cdot \mathbf{e}_{10, pn}\end{aligned}$$

The second axis is defined as follows:

$$\begin{aligned}\mathbf{e}_{2, wh} &= (R_{wh} \cdot \mathbf{e}_{20, wh}) \cos \theta_{wh} - (R_{wh} \cdot \mathbf{e}_{30, wh}) \sin \theta_{wh} \\ \mathbf{e}_{2, pn} &= (R_{pn} \cdot \mathbf{e}_{20, pn}) \cos \theta_{pn} - (R_{pn} \cdot \mathbf{e}_{30, pn}) \sin \theta_{pn}\end{aligned}$$

The third axis is defined as follows:

$$\begin{aligned}\mathbf{e}_{2, wh} &= (R_{wh} \cdot \mathbf{e}_{20, wh}) \sin \theta_{wh} + (R_{wh} \cdot \mathbf{e}_{30, wh}) \cos \theta_{wh} \\ \mathbf{e}_{2, pn} &= (R_{pn} \cdot \mathbf{e}_{20, pn}) \sin \theta_{pn} + (R_{pn} \cdot \mathbf{e}_{30, pn}) \cos \theta_{pn}\end{aligned}$$

where R_{wh} and R_{pn} are the rotation matrices of the wheel and the pinion, respectively. The angles θ_{wh} and θ_{pn} are the rotations of the wheel and pinion about the first axis of their respective local coordinate system.

GEAR TOOTH COORDINATE SYSTEM

The gear tooth coordinate system is defined by rotating the gear local coordinate system with the helix angle and cone angle.

$$\begin{aligned}\mathbf{e}_{it, wh} &= T_{wh}^T \cdot \mathbf{e}_{i, wh} & i = 1, 2, 3 \\ \mathbf{e}_{it, pn} &= T_{pn}^T \cdot \mathbf{e}_{i, pn} & i = 1, 2, 3\end{aligned}$$

where T_{wh} and T_{pn} are the tooth transformation matrix for the wheel and pinion, respectively.

The gear-to-tooth transformation matrix is defined as:

$$T = \begin{bmatrix} \cos\gamma\cos\beta & -\sin\gamma & \cos\gamma\sin\beta \\ \sin\gamma\cos\beta & \cos\gamma & \sin\gamma\sin\beta \\ -\sin\beta & 0 & \cos\beta \end{bmatrix}$$



For the pinion tooth coordinate system, the sign of the second axis ($\mathbf{e}_{2t, pn}$) and third axis ($\mathbf{e}_{3t, pn}$) are reversed to match the directions with the wheel tooth coordinate system.

LINE OF ACTION

The line of action is the normal direction of the gear tooth surface at the contact point on the pitch circle. This is the direction along which the motion is transferred from one gear to another gear. It is defined by rotating the third axis of the tooth coordinate system (\mathbf{e}_{3t}) about the first axis of the tooth coordinate system (\mathbf{e}_{1t}) with the pressure angle (α).

The line of action, also known as the pressure angle direction, is defined as follows:

For clockwise rotation of the third axis:

$$\mathbf{e}_{pa} = \mathbf{e}_{2t, wh} \sin\alpha + \mathbf{e}_{2t, wh} \cos\alpha$$

For counterclockwise rotation of the third axis:

$$\mathbf{e}_{pa} = -\mathbf{e}_{2t, wh} \sin\alpha + \mathbf{e}_{2t, wh} \cos\alpha$$

GEAR RATIO

The gear ratio (g_r) of a gear pair is defined as the ratio of angular velocities of the wheel (ω_{wh}) and the pinion (ω_{pn}):

$$g_r = \frac{\omega_{wh}}{\omega_{pn}}$$

It can also be written as the ratio of number of teeth of the pinion (n_{pn}) and the wheel (n_{wh}):

$$g_r = \frac{n_{pn}}{n_{wh}}$$

CONTACT POINT POSITION AND OFFSET

Contact Point Position

The point of contact (\mathbf{x}_{cp}) on a gear in its local coordinate system can be defined as:

$$\begin{aligned}\mathbf{x}_{cp, wh} &= \mathbf{x}_{c, wh} + \mathbf{u}_{wh} + z_{wh}\mathbf{e}_{1, wh} + (r_{wh} - z_{wh}\tan\gamma_{wh})\mathbf{e}_{2, wh} \\ \mathbf{x}_{cp, pn} &= \mathbf{x}_{c, pn} + \mathbf{u}_{pn} + z_{pn}\mathbf{e}_{1, pn} + (r_{pn} - z_{pn}\tan\gamma_{pn})\mathbf{e}_{2, pn}\end{aligned}$$

where, for the wheel and pinion, respectively:

- $\mathbf{x}_{cp, wh}$ and $\mathbf{x}_{cp, pn}$ are the positions of the contact points
- $\mathbf{x}_{c, wh}$ and $\mathbf{x}_{c, pn}$ are the centers of rotation
- \mathbf{u}_{wh} and \mathbf{u}_{pn} are the displacement vectors at the center of rotation
- z_{wh} and z_{pn} are the contact point offsets from the center of rotation in the axial direction
- r_{wh} and r_{pn} are the pitch radii
- γ_{wh} and γ_{pn} are the cone angles

Contact Point Offset

The contact point offset from the wheel or pinion center of rotation in the axial direction is defined as follows:

For a parallel or intersecting configuration, the contact point offset from the pinion center (z_{pn}) is the input. The contact point offset from the wheel center (z_{wh}) is defined as:

$$z_{wh} = (\mathbf{x}_{c, pn} - \mathbf{x}_{c, wh} + z_{pn}\mathbf{e}_{10, pn} + (r_{pn} - z_{pn}\tan\gamma_{pn})\mathbf{e}_{20, pn}) \cdot \mathbf{e}_{10, wh}$$

For a configuration that is neither parallel nor intersecting, the contact point offset from the pinion center (z_{pn}) and the contact point offset from the wheel center (z_{wh}) are defined as:

$$\begin{aligned}z_{pn} &= \frac{-(\mathbf{x}_{cd} \cdot \mathbf{e}_{10, pn}) - (\mathbf{x}_{cd} \cdot \mathbf{e}_{10, wh})x_{wh, pn}}{1 - x_{wh, pn}^2} \\ z_{wh} &= \frac{(\mathbf{x}_{cd} \cdot \mathbf{e}_{10, wh}) - (\mathbf{x}_{cd} \cdot \mathbf{e}_{10, pn})x_{wh, pn}}{1 - x_{wh, pn}^2}\end{aligned}$$

where

$$\mathbf{x}_{cd} = \mathbf{x}_{c, pn} - \mathbf{x}_{c, wh}$$

$$x_{wh, pn} = \mathbf{e}_{10, wh} \cdot \mathbf{e}_{10, pn}$$

GEAR PAIR CONSTRAINTS

Rotation Constraint

This constraint relates the pinion rotation to the wheel rotation:

$$\theta_{pn} = -\frac{\theta_{wh}}{g_r} + \theta_{el} + \theta_{et} + \theta_{bl}$$

where θ_{el} , θ_{et} , and θ_{bl} are the transmission error (elasticity), transmission error (static), and transmission error (backlash), respectively.

By default, there is no elasticity, transmission error, or backlash in a gear pair hence all these transmission errors are zero.



For more details about these transmission errors, see the [Theory for Gear Elasticity](#), [Theory for Transmission Error](#), and [Theory for Backlash](#) sections.

Point Contact Constraint

At the contact point, the relative motion along the line of action must be zero. This can be written as:

$$(\mathbf{x}_{cp, pn} - \mathbf{x}_{cp, wh}) \cdot \mathbf{e}_{pa} = 0$$

Line Contact Constraint

In case of a line contact model, an additional constraint is added at the second contact point. This can be written as:

$$\left(\mathbf{x}_{cp2, pn} - \mathbf{x}_{cp2, wh} - \frac{w_{pn}}{2} \theta_{cl} \mathbf{e}_{3, pn} \right) \cdot \mathbf{e}_{pa} = 0$$

where $\mathbf{x}_{cp2, wh}$ and $\mathbf{x}_{cp2, pn}$ are the position of the second contact point and can be defined as:

$$\left(\mathbf{x}_{cp2, wh} = \text{subst} \left(x_{cp, wh}, z_{wh}, z_{wh} + \frac{w_{pn} \cos \gamma_{wh}}{2 \cos \gamma_{pn}} \right) \right)$$

$$\mathbf{x}_{cp2, pn} = \text{subst} \left(x_{cp, pn}, z_{pn}, z_{pn} + \frac{w_{pn}}{2} \right)$$

Here, w_{pn} and θ_{cl} are the working width of the pinion and the relative rotation about centerline, respectively. By default, there is no elasticity on a gear pair hence the relative rotation about the centerline is zero.

Unique Triad Constraint

In case of planetary gears, there is a constraint to ensure that the local coordinate system of both the gears are still unique and well defined. This can be written as:

$$\mathbf{e}_{2t, wh} \cdot \mathbf{e}_{3t, pn} = 0$$

CONTACT FORCES AND MOMENTS

Contact Force

When you compute a contact force using weak constraints, the point contact constraint is implemented in the weak form and the corresponding Lagrange multiplier gives the contact force (\mathbf{F}_c).

Similarly, when you compute a contact force using a penalty method, the point contact constraint is implemented using the penalty factor and the corresponding penalty force gives the contact force (\mathbf{F}_c).

For the case of a line contact model, the second contact force (\mathbf{F}_{c2}) is computed by implementing the line contact constraint in the weak form or by using the penalty factor.

Contact Moment

When you compute a contact force using weak constraints, the unique triad constraint is implemented in the weak form and the corresponding Lagrange multiplier gives the moment at the contact point (\mathbf{M}_c).

Similarly, when you compute a contact force computation using a penalty method, the unique triad constraint is implemented using the penalty factor and the corresponding penalty moment gives the moment at the contact point (\mathbf{M}_c).

Force and Moment at Gear Centers

The forces at the gear centers are defined as:

$$\mathbf{F}_{wh} = -F_c \mathbf{e}_{pa}$$

$$\mathbf{F}_{pn} = F_c \mathbf{e}_{pa}$$

The moments at the gear centers are defined as:

$$\mathbf{M}_{wh} = (\mathbf{x}_{cp, pn} - \mathbf{x}_{wh} - \mathbf{u}_{wh}) \times (-F_c \mathbf{e}_{pa}) + M_c (\mathbf{e}_{2t, wh} \times \mathbf{e}_{3t, pn})$$

$$\mathbf{M}_{pn} = (\mathbf{x}_{cp, pn} - \mathbf{x}_{pn} - \mathbf{u}_{pn}) \times (F_c \mathbf{e}_{pa}) + (-M_c) (\mathbf{e}_{2t, wh} \times \mathbf{e}_{3t, pn})$$

For a line contact model, additional contributions from the contact force F_{c2} are added to the forces and moments at the gear centers. These contributions can be defined as:

$$\mathbf{F}_{wh} = -F_{c2} \mathbf{e}_{pa}$$

$$\mathbf{F}_{pn} = F_{c2} \mathbf{e}_{pa}$$

$$\mathbf{M}_{wh} = (\mathbf{x}_{cp2, pn} - \mathbf{x}_{wh} - \mathbf{u}_{wh}) \times (-F_{c2} \mathbf{e}_{pa})$$

$$\mathbf{M}_{pn} = (\mathbf{x}_{cp2, pn} - \mathbf{x}_{pn} - \mathbf{u}_{pn}) \times (F_{c2} \mathbf{e}_{pa})$$

Theory for Gear Elasticity

The **Gear Elasticity** node can be optionally added on gear pairs. In this node, you can specify the elastic properties of gear mesh, such as mesh stiffness, mesh damping, and contact ratio. By default, the gear mesh is assumed rigid.

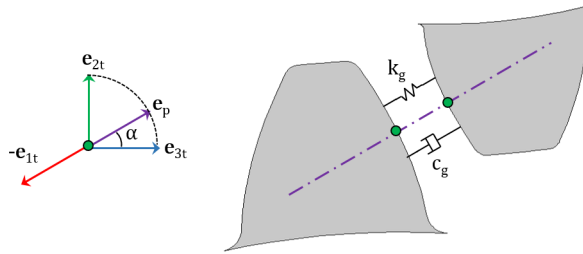

Figure 3-18: A sketch of a pair of teeth, showing the point of contact and the direction in which mesh stiffness and damping are interpreted.

The rest of this section discusses the following topics:

- [Degrees of Freedom](#)
- [Mesh Stiffness](#)
- [Elastic Moments](#)
- [Mesh Damping](#)

DEGREES OF FREEDOM

In this node, the transmission error (elasticity), θ_{el} , is a degree of freedom. This transmission error is added in the rotation constraint of the gear pair.

In the case of a line contact model, one more degree of freedom, θ_{cl} , is added. This is the relative rotation about the line joining the centers of two gears. The contribution of this rotation is added in the line contact constraint of the gear pair.

ELASTIC MOMENTS

The elastic moment about the first axis of the tooth coordinate system and its virtual work contribution are defined as:

$$M_{el} = -(k_g \theta_{el} + c_g \dot{\theta}_{el})(\mathbf{e}_{pa} \cdot \mathbf{e}_{3, pn})^2 r_{pn}^2$$

$$\delta W = M_{el} \cdot \delta \theta_{el}$$

In the case of a line contact model, the elastic moment about the second axis of the tooth coordinate system and its virtual work contribution are defined as:

$$M_{cl} = -(k_g \theta_{cl} + c_g \dot{\theta}_{cl})(\mathbf{e}_{pa} \cdot \mathbf{e}_{3, pn})^2 \frac{w_{pn}^2}{12}$$

$$\delta W = M_{cl} \cdot \delta \theta_{cl}$$

where

- k_g is the mesh stiffness of the gear pair
- c_g is the mesh damping of the gear pair
- r_{pn} is the pitch radius of the pinion
- w_{pn} is the working width of the pinion



The mesh damping contribution to the elastic moments will be zero in the case of a stationary analysis.

MESH STIFFNESS

Tooth Stiffness of Individual Gears

The mesh stiffness of the gear pair is defined as:

$$k_g = \frac{k_{wh}k_{pn}}{k_{wh} + k_{pn}}$$

where k_{wh} and k_{pn} are the mesh stiffness of the wheel and pinion.

The mesh stiffness of the wheel, for different contact ratios, is defined as follows.

Contact ratio is constant and set to 1:

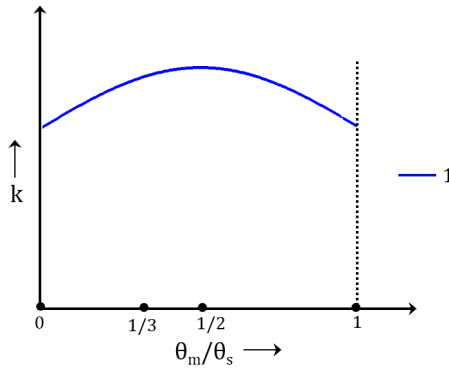

Figure 3-19: The graph shows the variation of the gear tooth stiffness in a mesh cycle.

The mesh stiffness of the wheel is defined as:

$$k_{wh} = k_{t,wh}(\theta_{m,wh})$$

where

- $k_{t,wh}$ is the gear tooth stiffness as function of mesh cycle
- $\theta_{m,wh}$ is the mesh cycle

The mesh cycle for the wheel is defined as:

$$\theta_{m,wh} = \text{mod}(\theta_{wh}, \theta_{s,wh}) \quad \theta_{s,wh} = \frac{2\pi}{n_{wh}}$$

Contact ratio is constant and set to 2:

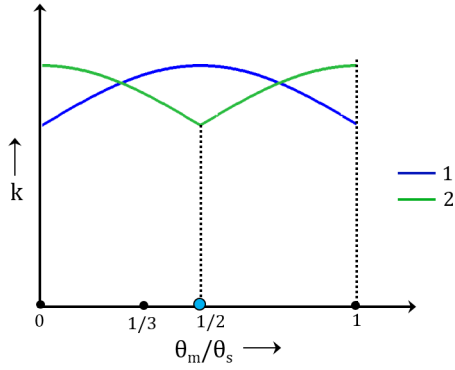

Figure 3-20: The graph shows the variation of the gear tooth stiffness of the first and second teeth in a mesh cycle.

The mesh stiffness of the wheel is defined as:

$$k_{wh} = k_{t,wh}(\theta_{m,wh}) + k_{t2,wh}$$

where $k_{t2,wh}$ is the tooth stiffness of the second tooth. It is defined as:

$$k_{t2,wh} = k_{t,wh}\left(\theta_{m,wh} + \frac{\theta_{s,wh}}{2}\right)$$

Contact ratio is constant and set to 3:

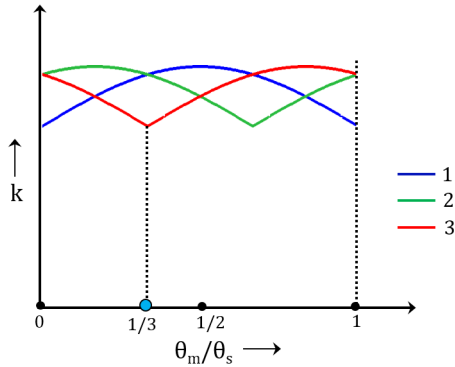

Figure 3-21: The graph shows the variation of the gear tooth stiffness of the first, second, and third teeth in a mesh cycle.

The mesh stiffness of the wheel is defined as:

$$k_{wh} = k_{t,wh}(\theta_{m,wh}) + k_{t2,wh} + k_{t3,wh}$$

where $k_{t2,wh}$ and $k_{t3,wh}$ are the tooth stiffness of the second and third teeth, respectively. They are defined as:

$$k_{t2,wh} = k_{t,wh}\left(\theta_{m,wh} + \frac{\theta_{s,wh}}{3}\right)$$

$$k_{t3,wh} = k_{t,wh}\left(\theta_{m,wh} + \frac{2\theta_{s,wh}}{3}\right)$$

Contact ratio is varying and maximum contact ratio is set to 2:

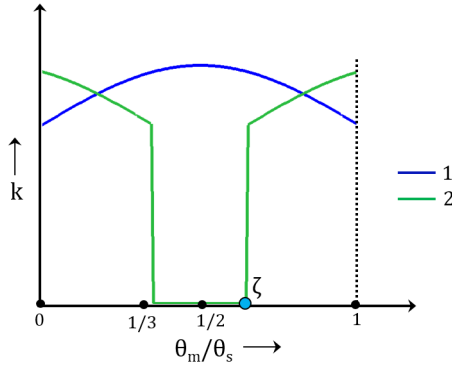

Figure 3-22: The graph shows the variation of the gear tooth stiffness of the first and second teeth in a mesh cycle.

The mesh stiffness of the wheel is defined as:

$$k_{wh} = k_{t,wh}(\theta_{m,wh}) + k_{t2f,wh} + k_{t2b,wh}$$

where $k_{t2f,wh}$ and $k_{t2b,wh}$ are the tooth stiffness of the second forward and backward teeth. They are defined as:

$$k_{t2f,wh} = (\theta_{m,wh} < (1 - \zeta)\theta_{s,wh}) \cdot k_{t,wh}(\theta_{m,wh} + \zeta\theta_{s,wh})$$

$$k_{t2b,wh} = (\theta_{m,wh} \geq \zeta\theta_{s,wh}) \cdot k_{t,wh}(\theta_{m,wh} - \zeta\theta_{s,wh})$$

where ζ is the next tooth engagement position in the mesh cycle. The value of ζ must be in the following range:

$$\frac{1}{2} \leq \zeta \leq 1$$

Contact ratio is varying and maximum contact ratio is set to 3:

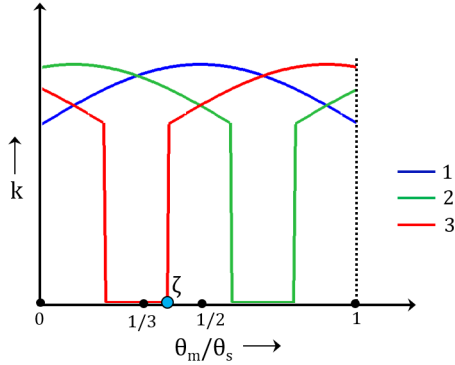

Figure 3-23: The graph shows the variation of the gear tooth stiffness of the first, second, and third teeth in a mesh cycle..

The mesh stiffness of the wheel is defined as:

$$k_{wh} = k_{t,wh}(\theta_{m,wh}) + k_{t2f,wh} + k_{t2b,wh} + k_{t3f,wh} + k_{t3b,wh}$$

where

- $k_{t2f,wh}$ and $k_{t2b,wh}$ are the tooth stiffness of the second forward and backward teeth.
- $k_{t3f,wh}$ and $k_{t3b,wh}$ are the tooth stiffness of the third forward and backward teeth.

$$\begin{aligned} k_{t2f,wh} &= (\theta_{m,wh} < (1 - \zeta)\theta_{s,wh}) \cdot k_{t,wh}(\theta_{m,wh} + \zeta\theta_{s,wh}) \\ k_{t2b,wh} &= (\theta_{m,wh} \geq 2\zeta\theta_{s,wh}) \cdot k_{t,wh}(\theta_{m,wh} - 2\zeta\theta_{s,wh}) \\ k_{t3f,wh} &= (\theta_{m,wh} < (1 - 2\zeta)\theta_{s,wh}) \cdot k_{t,wh}(\theta_{m,wh} + 2\zeta\theta_{s,wh}) \\ k_{t3b,wh} &= (\theta_{m,wh} \geq \zeta\theta_{s,wh}) \cdot k_{t,wh}(\theta_{m,wh} - \zeta\theta_{s,wh}) \end{aligned}$$

The value of ζ must be in the following range:

$$\frac{1}{3} \leq \zeta \leq \frac{1}{2}$$

Total Stiffness of Gear Pair

The mesh stiffness of gear pair is defined as follows:

Function of wheel mesh cycle:

$$k_g = k_g(\theta_{m, wh})$$
$$\theta_{m, wh} = \text{mod}(\theta_{wh}, \theta_{s, wh}) \quad \theta_{s, wh} = \frac{2\pi}{n_{wh}}$$

Function of wheel full revolution:

$$k_g = k_g(\theta_{f, wh})$$
$$\theta_{f, wh} = \text{mod}(\theta_{wh}, 2\pi)$$

Function of pinion mesh cycle:

$$k_g = k_g(\theta_{m, pn})$$
$$\theta_{m, pn} = \text{mod}(\theta_{pn}, \theta_{s, pn}) \quad \theta_{s, pn} = \frac{2\pi}{n_{pn}}$$

Function of pinion full revolution:

$$k_g = k_g(\theta_{f, pn})$$
$$\theta_{f, pn} = \text{mod}(\theta_{pn}, 2\pi)$$

MESH DAMPING

The mesh damping of a gear pair can be a constant value or it can be written as a function of mesh cycle or mesh stiffness.

Theory for Transmission Error

The **transmission Error** node can be optionally added on gear pairs. In this node, the static transmission error can be specified and added in the rotation constraint of the gear pair. By default, there is no transmission on the gear pair and it is assumed as an ideal pair.

The static transmission error could be due to geometrical errors and geometrical modifications, such as gear run outs, misalignments, tooth tip, and root relief.

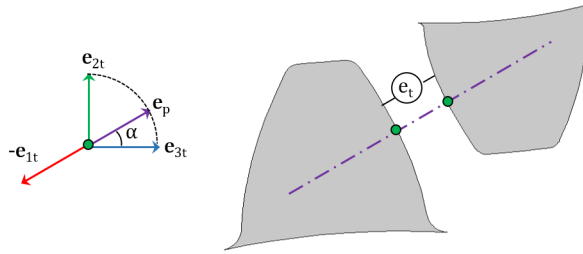

Figure 3-24: Sketch of a pair of teeth, showing the point of contact and the direction in which the transmission error is interpreted.

The static transmission error can be defined as:

$$\theta_{et} = \frac{e_t}{r_{pn}} \|(\mathbf{e}_{pa} \cdot \mathbf{e}_{3, pn})\|$$

$$e_t = e_{wh}(\theta_m, wh) + e_{pn}(\theta_m, pn)$$

where e_{wh} and e_{pn} are the wheel and pinion transmission errors, respectively.

In the above equation, e_{wh} and e_{pn} are written as a function of respective mesh cycle. However, it is also possible to write them individually as a function of a full revolution.

Similarly, it is also possible to directly specify e_t as a function of the mesh cycle and a full revolution of a wheel or pinion.

Theory for Backlash

The **Backlash** node can be optionally added on gear pairs. The transmission error due to backlash is added in the rotation constraint of the gear pair. By default, there is no backlash on a gear pair.

The backlash on a gear pair plays an important role for unloaded gears. For loaded gears, it does not affect the dynamics of gears to a large extent.



The backlash is taken into account only in the case of a time-dependent analysis.

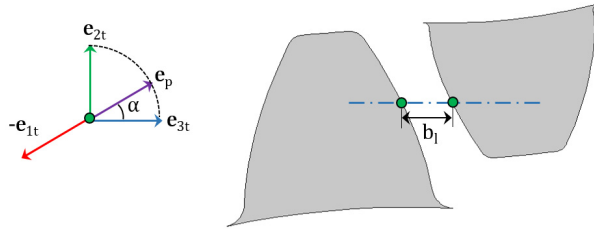

Figure 3-25: Sketch of a pair of teeth, showing the point of contact and the direction in which backlash is interpreted.

The transmission error (backlash), θ_{bl} , is degree of freedom in this node. The backlash moment about the first axis of the tooth coordinate system and its virtual work contribution are defined as:

$$M_b = -p_{bm}((\theta_{bl} < 0)\theta_{bl} + (\theta_{bl} > \theta_b)(\theta_{bl} - \theta_b))$$

$$\delta W = M_b \cdot \delta\theta_{bl}$$

$$\theta_b = \frac{\|b_1\|}{r_{pn}}$$

where b_1 and p_{bm} are the backlash and modified penalty factor, respectively.

To prevent the solver from taking larger time steps, the penalty factor is modified in the following manner:

$$p_{bm} = p_b + \text{if}(((\theta_{bl} < 0) + (\theta_{bl} > \theta_b)) \cdot (\Delta t > \Delta t_{\max}), \infty, 0)$$



The penalty factor is not modified for quasi-static analysis or when the manual control on time stepping is deselected.

The **Friction** node can be optionally added on gear pairs. In cases where friction is included on a gear pair, frictional forces in the plane perpendicular to the line of action are added on both the gears.



Friction can be applied to gear pairs only in a time-dependent analysis.

FRICITION MODEL

The friction force is modeled using a continuous friction law, which is capable of modeling sliding-sticking phenomena. A strict application of Coulomb's law involves discrete transition from sticking to sliding and vice versa, as dictated by a vanishing relative velocity. These discrete transitions cause numerical difficulties, and to avoid them, the friction force is approximated with a continuous friction law:

$$\mathbf{F}_f = -\mu N \frac{v}{|v|} \left(1 - e^{\frac{-|v|}{v_0}} \right)$$

where \mathbf{F}_f is the friction force, μ is the frictional coefficient, N is the normal force, v is the slip velocity, and v_0 is the characteristic slip velocity. The term

$$\left(1 - e^{\frac{-|v|}{v_0}} \right)$$

is called the regularization factor.

The regularization factor smooths the friction force discontinuity. The characteristic slip velocity should be made small in comparison to the characteristic relative velocities encountered during the simulation. The continuous friction law describes both sliding and sticking behavior; that is, it completely replaces Coulomb's law. Sticking is replaced by creeping between the contacting bodies with a small relative velocity.

NORMAL FORCE

The normal force at the contact point can be taken as the computed contact force. Alternatively, it can also be entered explicitly.

SLIP AT CONTACT POINT

The slip vector at the contact point of a gear pair is defined as:

$$\begin{aligned}\mathbf{u}_s &= (\mathbf{x}_{cp, pn} - \mathbf{x}_{cp, wh}) + (r_{pn}\theta_{pn}\mathbf{e}'_{3, pn} - r_{wh}\theta_{wh}\mathbf{e}'_{3, wh}) \\ \mathbf{e}'_{3, wh} &= \mathbf{e}_{3, wh} - (\mathbf{e}_{3, wh} \cdot \mathbf{e}_{pa})\mathbf{e}_{pa} \\ \mathbf{e}'_{3, pn} &= \mathbf{e}_{3, pn} - (\mathbf{e}_{3, pn} \cdot \mathbf{e}_{pa})\mathbf{e}_{pa}\end{aligned}$$

In 2D, the slip vector expression reduces to:

$$\mathbf{u}_s = (\mathbf{x}_{cp, pn} - \mathbf{x}_{cp, rk})$$

In the case of a line contact model, the slip at the second contact point is defined as:

$$\mathbf{u}_{s2} = (\mathbf{x}_{cp2, pn} - \mathbf{x}_{cp2, wh}) + (r_{pn}\theta_{pn}\mathbf{e}'_{3, pn} - r_{wh}\theta_{wh}\mathbf{e}'_{3, wh})$$

FRICITION FORCE

The friction force at the contact point and its virtual work contribution are defined as:

$$\begin{aligned}\mathbf{F}_f &= -\min(\mu N + F_{f, r}, F_{f, \max}) \frac{\dot{\mathbf{u}}_s}{\|\dot{\mathbf{u}}_s\|} \left(1 - e^{-\frac{\|\dot{\mathbf{u}}_s\|}{v_0}} \right) \\ \delta W &= \mathbf{F}_f \cdot \delta \mathbf{u}_s\end{aligned}$$

where $F_{f, r}$ and $F_{f, \max}$ are the additional sliding resistance and the maximum friction force, respectively.

Similarly, in the case of a line contact model, the friction force at the second contact point and its virtual work contribution are defined as:

$$\begin{aligned}\mathbf{F}_{f2} &= -\min(\mu N_2 + F_{f, r}, F_{f, \max}) \frac{\dot{\mathbf{u}}_{s2}}{\|\dot{\mathbf{u}}_{s2}\|} \left(1 - e^{-\frac{\|\dot{\mathbf{u}}_{s2}\|}{v_0}} \right) \\ \delta W &= \mathbf{F}_{f2} \cdot \delta \mathbf{u}_{s2}\end{aligned}$$

ENERGY DISSIPATION RATE

The energy dissipation rate due to friction at the contact point is defined as:



$$Q_f = -\mathbf{F}_f \cdot \dot{\mathbf{u}}_s$$

For a line contact model, the additional contribution in the energy dissipation rate is defined as:



$$Q_f = -\mathbf{F}_{f2} \cdot \mathbf{u}_{s2}$$

4

Solid Rotor

This chapter describes the Solid Rotor interface.  and its functionality, which is found under the **Structural Mechanics>Rotordynamics** branch  when adding a physics interface.

The Solid Rotor Interface

The **Solid Rotor (rotsld)** interface () is found under the **Structural Mechanics>Rotordynamics** branch () when adding a physics interface. It is intended for analysis of rotating structural components in 3D. With this interface, you can compute displacements, velocities, accelerations, and stresses. Journal and thrust bearing features provided in this interface can be used to model different type of bearings. You can also model the effect of a bearing mounted on a foundation.

The Linear Elastic Material is the default material model. It adds the equations for the displacements in a linear elastic rotor and has a Settings window to define the elastic and inertia properties of a material. The equations in this feature also account for the frame acceleration forces due to the rotation of the rotor.

With the Nonlinear Structural Materials Module, you can also incorporate nonlinear material models like creep or plasticity.

When the Solid Rotor interface is added, these default nodes are also added to the **Model Builder — Linear Elastic Material; Rotor Axis** (a domain feature to specify the axis of the rotor); **Free** (a boundary condition where boundaries are free, with no loads or constraints); **Initial Values**; and **Fixed Axial Rotation** (a reference surface where axial rotation relative to the rigid rotation of the rotor is zero). Then, from the **Physics** toolbar, you can add features that implement other rotor properties. You can also right-click **Solid Rotor** to select physics features from the context menu.

SETTINGS

The **Label** is the default physics interface name.

The **Name** is used primarily as a scope prefix for variables defined by the physics interface. Refer to such physics interface variables in expressions using the pattern `<name>.<variable_name>`. In order to distinguish between variables belonging to different physics interfaces, the `name` string must be unique. Only letters, numbers, and underscores (`_`) are permitted in the **Name** field. The first character must be a letter.

The default **Name** (for the first physics interface in the model) is `rotsld`.

ROTOR SPEED

Enter the **Rotor speed** as revolutions per time or angular velocity (variable `Ω`). This speed, together with the rotor axis, is used to compute the frame acceleration forces due to rotation of the rotor.

SPIN SOFTENING

Select the **Include spin softening** check box to add the effect of spin softening to the model. When the spin softening effect is included, the centrifugal and Euler forces are calculated based on the current position of the material particle during the deformation. However, if this effect is neglected, these forces do not change their magnitude based on the deformation.

REFERENCE POINT FOR MOMENT COMPUTATION

Enter the coordinates for the **Reference point for moment computation** \mathbf{x}_{ref} , (variable `refpnt`). The resulting moments (applied or as reactions) are then computed relative to this reference point. During the results and analysis stage, the coordinates can be changed in the **Parameters** section in the result nodes. The point is given as a material coordinate, that is in the rotating frame.

DEPENDENT VARIABLES

The physics interface uses the global spatial components of the **Displacement field** \mathbf{u} as dependent variables in the rotor domain. The default names for the components are (u, v, w) .

You can change both the field name and the individual component names. If a new field name coincides with the name of another displacement field, the two fields (and the interfaces that define them) share degrees of freedom and dependent variable component names.

A new field name must not coincide with the name of a field of another type (that is, it must contain a displacement field), or with a component name belonging to some other field. Component names must be unique within a model except when two interfaces share a common field name.

The **Flexible Foundation** node also adds two dependent vector variables, one for translation and one for rotation.

DISCRETIZATION

The discretization order applies to the flexible bodies. The default is to use **Quadratic** shape functions for the **Displacement field**.



- [Domain, Boundary, and Pair Nodes for the Solid Rotor Interface](#)
 - [Rotordynamics Theory](#)
-

Domain, Boundary, and Pair Nodes for the Solid Rotor Interface

The **Solid Rotor Interface** has domain, boundary, and pair nodes (and subnodes), listed in alphabetical order below, available from the **Physics** ribbon toolbar (Windows users), **Physics** context menu (Mac or Linux users), or by right-clicking the main physics interface node to access the context menu (all users).



In general, to add a node, go to the **Physics** toolbar, no matter what operating system you are using. Subnodes are available by clicking the parent node and selecting it from the **Attributes** menu.



In the *COMSOL Multiphysics Reference Manual*, see [Table 2-4](#) for links to common sections and [Table 2-5](#) for common feature nodes. You can also search for information: press F1 to open the **Help** window or Ctrl+F1 to open the **Documentation** window.



The links to the nodes described in external guides, such as the *Structural Mechanics Module User's Guide*, do not work in the PDF, only from the online help in COMSOL Multiphysics.

The following list contains links to the documentation for the domain and boundary nodes specific to the Solid Rotor interface:

- [Added Mass](#)
- [Applied Torque](#)
- [Bevel Gear](#)
- [Body Load](#)
- [Boundary Load](#)
- [Change Rotor Speed](#)
- [Fixed Axial Rotation](#)
- [Gear Pair](#)
- [Gravity](#)
- [Helical Gear](#)
- [Initial Values](#)
- [Journal Bearing](#)
- [Linear Elastic Material](#)
- [Multi-Spool Bearing](#)
- [Radial Roller Bearing](#)
- [Rotor Axis](#)
- [Rotor Coupling](#)
- [Spur Gear](#)
- [Thrust Bearing](#)

These subnodes are available from the main parent nodes as indicated in the documentation:

- [Axis](#)
- [First Support](#)
- [Flexible Foundation](#)
- [Initial Values \(Gear\)](#)
- [Misalignment](#)
- [Moving Foundation](#)
- [Second Support](#)
- [Squeeze Film Damper](#)

These nodes are described in detail for the Solid Mechanics Interface:

- [Creep](#)
- [Damping](#)
- [External Strain](#)
- [External Stress](#)
- [Initial Stress and Strain](#)
- [Linear Elastic Material](#)
- [Phase](#)
- [Plasticity](#)
- [Rigid Domain](#)
- [Thermal Expansion \(for Materials\)](#)
- [Viscoelasticity](#)
- [Viscoplasticity](#)

Initial Values

The **Initial Values** node adds initial values for the displacement field and structural velocity field that can serve as an initial condition for a transient simulation or as an initial guess for a nonlinear analysis. In addition to the default **Initial Values** node always present in the interface, you can add more **Initial Values** nodes if needed. The values are given in the rotating frame.

INITIAL VALUES

Enter values or expressions for the initial values of the **Displacement field \mathbf{u}** (the displacement components u , v , and w), and the **Structural velocity field $\partial\mathbf{u}/\partial t$** .

LOCATION IN USER INTERFACE

Context Menus

Solid Rotor>Initial Values

Ribbon

Physics tab with **Solid Rotor** selected:

Linear Elastic Material

The **Linear Elastic Material** node adds the equations for a linear elastic rotor and an interface for defining the elastic material properties.

By adding the following subnodes to the **Linear Elastic Material** node, you can incorporate many other effects:

- [Thermal Expansion \(for Materials\)](#)
- [Initial Stress and Strain](#)
- [External Stress](#)
- [External Strain](#)
- [Damping](#)
- [Viscoelasticity](#)
- [Plasticity](#)
- [Creep](#)

Note: Some options are only available with certain COMSOL products (see <http://www.comsol.com/products/specifications/>).

COORDINATE SYSTEM SELECTION

The **Global coordinate system** is selected by default. The **Coordinate system** list contains any additional coordinate systems that the model includes (except boundary coordinate systems). The coordinate system is used for interpreting directions of orthotropic and anisotropic material data and when stresses or strains are presented in a local system. The coordinate system must have orthonormal coordinate axes and be defined in the material frame. The material frame will in this context interpreted as the corotating system. Many of the possible subnodes inherit the coordinate system settings.

LINEAR ELASTIC MATERIAL

To use a mixed formulation by adding the pressure as an extra dependent variable to solve for, select the **Nearly incompressible material** check box. For a material with a very low compressibility, using only displacements as degrees of freedom may lead to a numerically ill-posed problem.

Define the **Solid model** and the linear elastic material properties.

Solid Model

Select a linear elastic **Solid model** — **Isotropic**, **Orthotropic**, or **Anisotropic**. Select:

- **Isotropic** for a linear elastic material that has the same properties in all directions.
- **Orthotropic** for a linear elastic material that has different material properties in orthogonal directions, so that its stiffness depends on the properties E_i , ν_{ij} , and G_{ij} .
- **Anisotropic** for a linear elastic material that has different material properties in different directions, and the stiffness comes from the symmetric elasticity matrix, D .



In the Structural Mechanics Theory chapter of the *Structural Mechanics Module User's Guide*:

- [Material Models](#)
- [Linear Elastic Material](#)
- [Orthotropic and Anisotropic Materials](#)

In the Solid Mechanics chapter of the *Structural Mechanics Module User's Guide*:

- [Linear Elastic Material](#)

Density

The default **Density** ρ uses values **From material**. For **User defined** enter another value or expression.

GEOMETRIC NONLINEARITY

The settings in this section affect the behavior of the selected domains in a geometrically nonlinear analysis.

Force Linear Strains

If a study step is geometrically nonlinear, the default behavior is to use a large strain formulation in all domains. There are, however, some rare cases when the use of a small strain formulation for a certain domain is needed.

In such cases, select the **Force linear strains** check box. When selected, a small strain formulation is always used, independently of the setting in the study step.



- [Modeling Geometric Nonlinearity](#)
- [Studies and Solvers](#) in the *COMSOL Multiphysics Reference Manual*

ENERGY DISSIPATION

The section is available when you also have the Geomechanics Module or the Nonlinear Structural Materials Module. Then, to display this section, click the **Show More Options** button () and select **Advanced Physics Options** in the **Show More Options** dialog box.

Select the **Calculate dissipated energy** check box as needed to compute the energy dissipated by **Creep**, **Plasticity**, **Viscoplasticity**, or **Viscoelasticity**.

LOCATION IN USER INTERFACE

Context Menus

Solid Rotor>Material Models>Linear Elastic Material

Ribbon

Physics tab with **Solid Rotor** selected:

Domains>Material Models>Linear Elastic Material

Rotor Axis

In the **Rotor Axis** node, you define the initial axis about which the rotor rotates.

ROTOR AXIS

From the **Specified by** list, select how to specify the rotor axis — **Support locations** or **Edge**.

Support Locations

Select **Support locations** — **Selected points** or **User defined**. If you choose **Selected points**, it automatically adds two subnodes with point selection, **First Support** and **Second Support**. Select the respective points in the selection list of these sub-nodes. If you choose **User defined**, enter the coordinates \mathbf{r}_1 and \mathbf{r}_2 of the two supports on the rotor axis.

The support points are only used for defining the rotor axis.

Edge

An **Axis** subnode with an edge selection is automatically added. Select the edge representing the rotor axis in the selection list of this node.



See also

- [Specifying the Rotor Axis](#) in the Rotordynamics Modeling chapter.
 - [Rotor Axis](#) in the Rotordynamics Theory chapter.
-

LOCATION IN USER INTERFACE

Context Menus

Solid Rotor>Rotor Axis

Ribbon

Physics tab with **Solid Rotor** selected:

Boundaries>Solid Rotor>Rotor Axis

First Support

Use the **First Support** node to select any point or set of points whose centroid represents the location of the first support on the rotor axis.

LOCATION IN USER INTERFACE

This node is automatically added when the rotor axis is specified by **Support locations** in the parent **Rotor Axis** node and **Support locations** are defined using **Selected points**. It cannot be added or removed manually.

Second Support

Use the **Second Support** node to select any point or set of points whose centroid represents the location of the second support on the rotor axis.

LOCATION IN USER INTERFACE

This node is automatically added when the rotor axis is specified by **Support locations** in the parent **Rotor Axis** node and **Support locations** are defined using **Selected points**. It cannot be added or removed manually.

Axis

Use the **Axis** node to select the edge that represents the axis of the rotor.

LOCATION IN USER INTERFACE

This node is automatically added when the rotor axis is specified by **Edge** in the parent **Rotor Axis** node. It cannot be added or removed manually.

Fixed Axial Rotation

Use the default **Fixed Axial Rotation** node to select a rotor cross section that is treated as a reference for the axial (torsional) rotation of the rotor.

LOCATION IN USER INTERFACE

Context Menus

Solid Rotor>Fixed Axial Rotation

Ribbon

Physics tab with **Solid Rotor** selected:

Boundaries>Solid Rotor>Fixed Axial Rotation

Change Rotor Speed

Use the **Change Rotor Speed** node to selectively specify the speed of the rotor if it is different from what is specified in the interface. This feature is useful for multirotor systems operating at different speeds, for example, in a geared rotor system where the speed of the shafts is in the ratio specified by the gear ratio. Select either **Revolutions per time** or **Angular velocity** to choose the unit for the angular speed and then enter the value in the text field.

LOCATION IN USER INTERFACE

Context Menus

Solid Rotor>Change Rotor Speed

Beam Rotor>Change Rotor Speed

Ribbon

Physics tab with **Solid Rotor** selected:

Domains>Solid Rotor>Change Rotor Speed

Physics tab with **Beam Rotor** selected:

Edges>Beam Rotor>Change Rotor Speed

Journal Bearing

Add a **Journal Bearing** node to model the effect of a bearing. The selected boundaries should form a cylindrical surface representing the journal of the bearing.

If clearance is incorporated, you can also study the effect of misalignment by adding a [Misalignment](#) subnode.

BEARING ORIENTATION

Use the settings in this section to define the local *y* direction of the bearing. Subsequent vector and matrix inputs are specified in the local directions specified here.

Enter the **Bearing orientation vector defining the local *y* direction**. The direction given will be adjusted so that it is orthogonal to the rotor axis. The default value is the global *y*-axis.

You can further modify the *y*-axis orientation by entering an angle for the **Rotation of the orientation vector around the bearing axis**. The direction inferred from the previous setting will be rotated counterclockwise around the rotor axis.

BEARING PROPERTIES

Select a **Bearing Model** — **No clearance**, **Plain hydrodynamic**, **Total spring and damping constant**, **Total force and moment**, or **Force per unit area**. Then go to the relevant section below to continue defining the properties.

Plain Hydrodynamic

Enter the **Bulk viscosity**, μ , of the lubricant, the **Clearance**, C , between the journal and bushing, and the **Journal length**, L . For the **Bulk viscosity**, select **From material** to use data from a material assigned to the selected journal boundaries, or select **User defined** to enter a value or expression.

The values are used to calculate the stiffness and damping constants by linearization of the total forces and moments obtained with a short bearing approximation in the Reynolds equation.

Total Spring and Damping Constant

Enter the translational and bending stiffness k_u and k_θ . Select the **Translational-rotational coupling** check box to also model the coupling between

translational and rotational motion of the journal. Enter the values of the additional inputs $k_{u\theta}$ and $k_{\theta u}$ in this case. If you want to perform dynamic analysis, you can also enter nonzero translational and bending damping constants c_u and c_θ . Select the **Translational-rotational coupling** check box, and enter $c_{u\theta}$ and $c_{\theta u}$ values to include the translational-rotational coupling in the damping constants. Default values for the rotational stiffness and damping constants are provided as functions of the translational counterparts. It is assumed that the translational stiffness and damping constants are uniformly distributed on the given selection. The equivalent moment experienced at the center of the bearing due to this distribution is considered as the moment from the bearing. The variables `<phys>. <feat>. E11` and `<phys>. <feat>. area` appearing the default expression are the 11 component of the Euler tensor, and the area of the journal, respectively. The 1 direction represents the axial direction of the bearing.

Total Force and Moment

Enter the **Total force**, \mathbf{F} , and **Total Moment**, \mathbf{M} , as a function of journal displacement and rotation. To help specifying the input as functions of journal displacement and rotation, default expressions are provided for these inputs. These expressions contain variables of the type `<phys>. <feat>. {du2_c, du3_c, dth2, dth3}`, which are lateral components of the relative displacement and rotation of the journal with respect to the bearing at the center, expressed in the local bearing directions.

Force per Unit Area

Enter the **Force per unit area**, \mathbf{F}_A , in the matrix. This option is useful if the distributed force on the journal surface is known. To help specifying inputs as a function of journal displacement a default expression is provided. This expression contains variables of the type `<phys>. <feat>. {du2, du3}`, which are lateral components of the relative surface displacement of the journal with respect to the bearing, in the local bearing directions.

Clear the **Constrain axial motion** check box (selected by default) if you want to use a separate **Thrust Bearing** node to restrict the axial motion.

FOUNDATION PROPERTIES

Select one of the **Fixed**, **Moving**, **Flexible**, or **Squeeze film damper** foundation options. In the **Moving**, **Flexible**, and **Squeeze film damper** cases, the subnodes [Moving Foundation](#), [Flexible Foundation](#), or [Squeeze Film Damper](#) are automatically added.

LOCATION IN USER INTERFACE

Context Menus

Solid Rotor>Journal Bearing

Ribbon

Physics tab with **Solid Rotor** selected:

Boundaries>Solid Rotor>Journal Bearing

Thrust Bearing

Add a **Thrust Bearing** node to model a cross section where a thrust bearing is acting. The selected boundaries should form a circular surface representing the cross section of the rotor.

If clearance is incorporated, you can also study the effect of misalignment by adding a [Misalignment](#) subnode.

BEARING ORIENTATION

Use the settings in this section to define the local y direction of the bearing. Subsequent vector and matrix inputs are specified in the local directions specified here.

Enter the **Bearing orientation vector defining the local y direction**. The direction given will be adjusted so that it is orthogonal to the rotor axis. The default value is the global y -axis.

You can further modify the y -axis orientation by entering an angle for the **Rotation of the orientation vector around the bearing axis**. The direction inferred from the previous setting will be rotated counterclockwise around the rotor axis.

BEARING PROPERTIES

Select a **Bearing Model** — **No clearance**, **Total spring and damping constant**, **Total force and moment**, or **Force per unit area**. Then go to the relevant section below to continue defining the properties.

Total Spring and Damping Constant

Enter the axial and bending stiffness, k_u and k_θ . Select the **Translational-rotational coupling** check box to also model the coupling between the axial and rotational motion of the collar. Enter expressions for the additional inputs, $k_{u\theta}$ and $k_{\theta u}$ in this case. If you want to perform dynamic analysis, you can also provide nonzero axial and bending damping constants c_u and c_θ . Select the **Translational-rotational coupling** check box and enter $c_{u\theta}$ and $c_{\theta u}$ values to include the translational-rotational coupling in the damping constants. Default values for the rotational stiffness and damping constants are provided as functions of the axial stiffness. It is assumed that the axial stiffness and damping constants are uniformly

distributed on the given selection. The equivalent moment experienced at the center of the collar due to this distribution is considered as the moment from the bearing. The variables $\langle \text{phys} \rangle \cdot \langle \text{feat} \rangle \cdot E_{\{22,33,23,32\}}$ and $\langle \text{phys} \rangle \cdot \langle \text{feat} \rangle \cdot \text{area}$ appearing in the default expression are the components of the Euler tensor and area of the collar, respectively. Component indices in the variable E represent the respective components of the Euler tensor in the local bearing directions.

Total Force and Moment

Enter the **Total force**, F_{ax} , and **Total moment**, \mathbf{M} , as functions of collar displacement and rotation. To help specifying the force and moment as functions of collar displacement and rotation, default expressions are provided for these inputs. These expressions contain variables of the type $\langle \text{phys} \rangle \cdot \langle \text{feat} \rangle \cdot \{du1c, dth2, dth3\}$, which are relative axial displacement and lateral components of the relative rotation of the collar with respect to the bearing at the center, in the local bearing directions.

Force per Unit Area

Enter the axial force per unit area, $F_{\text{ax},A}$, in the matrix. This option is useful if the distributed force on the collar surface is known. To help specifying the input as a function of collar axial displacement a default expression is provided. This expression contains the variable $\langle \text{phys} \rangle \cdot \langle \text{feat} \rangle \cdot du1$, which is the axial component of the relative surface displacement of the collar with respect to the bearing.

Select the **Constrain lateral motion** check box (cleared by default) if you do not want to use a separate **Journal Bearing** node to restrict the lateral motion.

FOUNDATION PROPERTIES

Select one of the **Fixed**, **Moving**, or **Flexible** foundation options. In the **Moving** and **Flexible** cases, the subnodes **Moving Foundation** or **Flexible Foundation** are automatically added.

LOCATION IN USER INTERFACE

Context Menus

Solid Rotor>Thrust Bearing

Ribbon

Physics tab with **Solid Rotor** selected:

Boundaries>Solid Rotor>Thrust Bearing

Radial Roller Bearing

Add a **Radial Roller Bearing** node to model a surface on the rotor supported by a roller bearing. The selected boundaries should form a cylindrical surface representing the surface connected with the inner race of the bearing. The forces on the rollers are computed using the Hertz contact theory. The built-in variables for the roller force distribution has the form `<physicsName>.<RollerBearingTag>.fb[x,y,z]`, for example `rotsld.rrb1.fbx`.

You can also study the effect of misalignment by adding a [Misalignment](#) subnode.

BEARING ORIENTATION

Use the settings in this section to define the local *y* direction of the bearing. Subsequent vector and matrix inputs are specified in the local directions specified here.

Enter the **Bearing orientation vector defining the local *y* direction**. The direction given will be adjusted so that it is orthogonal to the rotor axis. The default value is the global *y*-axis.

You can further modify the *y*-axis orientation by entering an angle for the **Rotation of the orientation vector around the bearing axis**. The direction inferred from the previous setting will be rotated counterclockwise around the rotor axis.

GEOMETRIC PROPERTIES

Select a **Bearing Type** — **Deep groove ball bearing**, **Angular contact ball bearing**, **Self aligning ball bearing**, **Spherical roller bearing**, **Cylindrical roller bearing**, or **Tapered roller bearing**. Then go to the relevant section below to continue defining the properties.

Deep Groove Ball Bearing

- Select either **Single row** or **Double row** to specify if the bearing consists of single or double rows of rollers.
- For a **Double row** bearing, enter the **Axial distance between the roller centers**.
- Enter the renaming geometric properties **Number of balls**; **Ball diameter**; **Radial clearance**; **Pitch diameter**; **Contour radius, inner race**; and **Contour radius, outer race** to define the bearing geometry.

Angular Contact Ball Bearing

- Select either **Single row** or **Double row** to specify if the bearing consists of single or double rows of rollers.

- For a **Double row** bearing, enter the **Axial distance between the roller centers**.
- Enter the remaining geometric properties **Number of balls; Ball diameter; Radial clearance; Pitch diameter; Contour radius, inner race; Contour radius, outer race;** and **Initial contact angle** to define the bearing geometry.

Self Aligning Ball Bearing

- Select either **Single row** or **Double row** to specify if the bearing consists of single or double rows of rollers.
- Enter the geometric properties **Number of balls; Ball diameter; Radial clearance; Pitch diameter; Contour radius, inner race;** and **Contour radius, outer race**.
- For a **Double row** bearing, enter also **Initial contact angle**.

Spherical Roller Bearing

- Select either **Single row** or **Double row** to specify if the bearing consists of single or double rows of rollers.
- For a **Double row** bearing, enter the **Axial distance between the roller centers** and **Initial contact angle**.
- Enter the remaining geometric properties **Number of rollers; Roller diameter; Radial clearance; Pitch diameter; Contour radius, inner race;** and **Contour radius, outer race** to define the bearing geometry.

Cylindrical Roller Bearing

- Select either of **Single row** or **Double row** to specify if the bearing consists of single or double rows of rollers.
- For a **Double row** bearing, enter the **Axial distance between the roller centers**.
- Enter the remaining geometric properties **Number of rollers, Effective length of the roller, Radial clearance,** and **Pitch diameter** to define the bearing geometry.

Tapered Roller Bearing

- Select either of **Single row** or **Double row** to specify if the bearing consists of single or double rows of rollers.
- For **Single row** bearing, enter the **Axial offset of roller center**.
- For **Double row** bearing enter the **Axial distance between the roller centers**.
- Enter the remaining geometric properties **Number of rollers, Roller diameter, Effective length of the roller, Inner race clearance, Outer race clearance, Flange clearance, Pitch diameter, Cap radius, Semi cone angle, Roller axis orientation, Cap angle,** and **Flange contact angle** to define the bearing geometry.

MATERIAL PROPERTIES

- Enter the material properties **Young's modulus, inner race** and **Poisson's ratio, inner race** to define the elastic properties of the inner race in the bearing.
- Select **Outer race material** — **Same as inner race** or **User defined**. If **User defined** is selected, enter the values of **Young's modulus, outer race** and **Poisson's ratio, outer race**.
- Finally select **Roller material** — **Same as inner race** or **User defined**. If **User defined** is selected, enter the values of the **Young's modulus, roller/ball** and **Poisson's ratio, roller/ball**.

FOUNDATION PROPERTIES

Select one of the **Fixed**, **Moving**, **Flexible**, or **Squeeze film damper** foundation options. In the **Moving**, **Flexible**, and **Squeeze film damper** cases, the subnodes [Moving Foundation](#), [Flexible Foundation](#), or [Squeeze Film Damper](#) are automatically added.

LOCATION IN USER INTERFACE

Context Menus

Solid Rotor>Radial Roller Bearing

Ribbon

Physics tab with **Solid Rotor** selected:

Boundaries>Solid Rotor>Radial Roller Bearing

Flexible Foundation

The **Flexible Foundation** node is added automatically when you set **Foundation properties** to **Flexible** on the parent **Journal Bearing**, **Thrust Bearing**, or **Radial Roller Bearing** node. In this node, you describe the flexibility of the foundation on which the bearing is mounted.

FOUNDATION PROPERTIES

Enter the values of the translational and rotational stiffness k_u and k_θ of the foundation. Select the **Translational-rotational coupling** check box to also incorporate the effect of coupled stiffness between the translational and rotational motion of the foundation. If selected, enter the values of the coupling stiffnesses, $k_{u\theta}$ and $k_{\theta u}$.

If you want to perform a dynamic analysis, you can optionally also enter the values of the translational and rotational damping, c_u and c_θ , of the foundation. Select the

Translational-rotational coupling check box to also incorporate the effect of coupled damping constants between the translational and angular velocity of the foundation. If selected, enter the values of the coupling damping constants $c_{u\theta}$ and $c_{\theta u}$.

LOCATION IN USER INTERFACE

This node is automatically added when **Foundation Properties** is **Flexible** in the parent bearing node. It cannot be added or removed manually.

Moving Foundation

The **Moving Foundation** node is added automatically when you set **Foundation properties** to **Moving** on the parent **Journal Bearing**, **Thrust Bearing**, or **Radial Roller Bearing** node. In this node, you prescribe the motion of the foundation on which the bearing is mounted.

FOUNDATION PROPERTIES

Enter the values of the **Foundation displacement**, \mathbf{u}_f , and **Foundation rotation**, θ_f , at the center of the bearing.

LOCATION IN USER INTERFACE

This node is automatically added when **Foundation Properties** is **Moving** in the parent bearing node. It cannot be added or removed manually.

Squeeze Film Damper

The **Squeeze Film Damper** node is added automatically when you set **Foundation properties** to **Squeeze film damper** in the parent **Journal Bearing** or **Radial Roller Bearing** node. In this node, you specify the damper dimensions and lubricant properties to compute the equivalent damping coefficient based on a short bearing length approximation.

DAMPER PROPERTIES

Select **Bulk viscosity**—**From material** or **User defined**. If **User defined**, enter the value of the **Bulk viscosity**, μ . Enter the values of **Clearance**, C , and **Journal length**, L .

CENTERING SPRING

Centering springs are used in squeeze film dampers to allow them to support static loads. Enter the values of **Spring constant**, k_{cs} , and **Damping constant**, c_{cs} , for the centering spring.

LOCATION IN USER INTERFACE

This node is automatically added when **Foundation Properties** is set to **Squeeze Film Damper** in the parent bearing node. It cannot be added or removed manually.

Misalignment

Use the **Misalignment** node to model the effect of the misalignment of bearings or couplings on the shaft. It can be added to all nodes describing bearings in the Solid Rotor and Beam Rotor interfaces, as well as to the **Rotor Coupling** node.

To model misalignment, you specify the parallel or angular misalignment values. For the stiffness-based bearing models such as **Radial Roller Bearing**, **Journal Bearing**, and **Thrust Bearing**, misalignment works similar to predeformation in springs. For the **Hydrodynamic Bearings**, the misalignment affects the film thickness distribution in the bearing which governs the pressure distribution in the film.



Under **Journal Bearing** and **Thrust Bearing**, you cannot add **Misalignment** if **No clearance** selected as **Bearing Model**.

MISALIGNMENT

Enter the values of the parallel misalignment u_{20} and u_{30} (for radial or journal bearing only) and angular misalignment θ_{20} and θ_{30} .

LOCATION IN USER INTERFACE

Context Menus

Solid Rotor>Journal Bearing>Misalignment

Solid Rotor>Thrust Bearing>Misalignment

Solid Rotor>Radial Roller Bearing>Misalignment

Solid Rotor>Multi-Spool Bearing>Misalignment

Solid Rotor>Rotor Coupling>Misalignment

Beam Rotor>Journal Bearing>Misalignment

Beam Rotor>Thrust Bearing>Misalignment

Beam Rotor>Radial Roller Bearing>Misalignment

Beam Rotor>Multi-Spool Bearing>Misalignment

Beam Rotor>Rotor Coupling>Misalignment

Hydrodynamic Bearing>Hydrodynamic Journal Bearing>Misalignment

Hydrodynamic Bearing>Hydrodynamic Thrust Bearing>Misalignment

Hydrodynamic Bearing>Floating Ring Bearing>Misalignment

Ribbon

Physics tab with **Radial Roller Bearing**, **Journal Bearing**, **Thrust Bearing**, **Multi-Spool Bearing**, or **Rotor Coupling** selected in the Solid Rotor or Beam Rotor interfaces:

Attributes>Misalignment

Physics tab with **Hydrodynamic Journal Bearing**, **Hydrodynamic Thrust Bearing**, or **Floating Ring Bearing** selected in the Hydrodynamic Bearing interface:

Attributes>Misalignment

Multi-Spool Bearing

Add a **Multi-Spool Bearing** node to model an intershaft bearing between two rotors running at different speeds. The journal surface of the shaft should be selected in the **Boundary Selection** section (Beam Rotor: **Point Selection**). Surfaces on the other shaft connected to the bearing bushing should be selected in the **Destination Boundary Selection** Beam Rotor: **Destination Point Selection**).

BEARING ORIENTATION

Use the settings in this section to define the local *y* direction of the bearing. Subsequent vector and matrix inputs are specified in the local directions specified here.

Enter the **Bearing orientation vector defining the local *y* direction**. The direction given will be adjusted so that it is orthogonal to the rotor axis. The default value is the global *y*-axis.

You can further modify the *y*-axis orientation by entering an angle for the **Rotation of the orientation vector around the bearing axis**. The direction inferred from the previous setting will be rotated counterclockwise around the rotor axis.

BEARING PROPERTIES

Use the settings in this section to specify the bearing stiffness and damping coefficients between the two shafts.

Select **Displacement connection** —**Rigid** or **Flexible**. If **Rigid** is selected, the bearing acts as an infinite stiffness bearing for the relative translation motion between the two shafts. For the **Flexible** case, enter the values of the **Translational stiffness** (2x2 matrix) and **Translational damping coefficient** (2x2 matrix). A zero stiffness will make both shafts free for relative translational motion.

Select **Rotation connection** — **Rigid** or **Flexible**. If **Rigid** is selected, the bearing acts as an infinite stiffness bearing for the relative tilting motion between the two shafts. For the **Flexible** case, enter the values of the **Bending stiffness** (2x2 matrix) and **Bending damping coefficient** (2x2 matrix). A zero stiffness will make both shafts free for relative tilting motion.

LOCATION IN USER INTERFACE

Context Menus

Solid Rotor>Multi-Spool Bearing

Beam Rotor>Multi-Spool Bearing

Ribbon

Physics tab with **Solid Rotor** selected:

Boundaries>Solid Rotor>Multi-Spool Bearing

Physics tab with **Beam Rotor** selected:

Points>Beam Rotor>Multi-Spool Bearing

Rotor Coupling

Add a **Rotor Coupling** node to model the coupling characteristics between two rotors. The selection for this feature should be a cross section of the rotor.

COUPLING PROPERTIES

Select **Coupling type** — **Spline**, **Torsional**, or **User defined**. Then, go to the relevant section below to continue defining the properties.

Spline

No extra input is needed. This coupling type connects the displacement and axial rotation across the two rotors, while keeping the tilting of the rotors uncoupled on interior boundaries. On exterior boundaries, only the axial rotation is fixed.

Torsional

Enter the value of the **Torsional stiffness**, $k_{\theta,ax}$. This coupling type connects displacement and tilting rotations across the two rotors on interior boundaries. The axial rotation of both rotors are connected by a spring of stiffness $k_{\theta,ax}$. On an exterior boundary, displacement and tilting rotations are free, while the axial rotation is connected by a spring of stiffness $k_{\theta,ax}$ relative to an imaginary fixed boundary.

User Defined

Select **Displacement connection** — **Rigid** or **Flexible**. In the **Flexible** case, enter the **Translational stiffness**, k_u . The displacements across the two rotors will be connected through a spring with the given stiffness. In the **Rigid** case, the displacements of both rotors are rigidly connected. On an exterior boundary, the other rotor is assumed to be fixed.

Select **Axial rotation connection** — **Flexible** or **Rigid**. In the **Flexible** case, enter the **Torsional stiffness**, $k_{\theta,ax}$. The axial rotation across the two rotors is connected by a torsional spring of the given stiffness. In the **Rigid** case, the axial rotations of both rotors are rigidly connected. On an exterior boundary, the other rotor is assumed to be fixed.

Select the **Bending rotation connection** — **Flexible** or **Rigid**. In the **Flexible** case, enter the **Bending stiffness**, $k_{\theta,b}$. The bending rotation across the two rotors is connected by a spring of the given stiffness. In the **Rigid** case, tilting rotations of both the rotors are rigidly connected. On an exterior boundary, the other rotor is assumed to be fixed.

LOCATION IN USER INTERFACE

Context Menus

Solid Rotor>Rotor Coupling

Ribbon

Physics tab with **Solid Rotor** selected:

Boundaries>Solid Rotor>Rotor Coupling

Body Load

Add a **Body Load** to domains for modeling volumetric loads.

FRAME TYPE

Select a **Frame type** — **Spatial** or **Corotating** to specify the load in the appropriate frame.



- Since the rotor is modeled in a rotating frame, a stationary load in a **Corotating** frame works as a stationary load in the model. A stationary load in the **Spatial** frame will, however, change its direction with the angular velocity of the rotor, and therefore acts as a time-dependent load in the model.
- For a frequency domain analysis, a load in the **Spatial** frame is phase shifted to give the effect of the rotation.
- For a stationary analysis, **Frame type** has no influence on the analysis.

FORCE

Select a **Load type** — **Load defined as force per unit volume**, or **Total force**.

Then enter values or expressions for the force components based on the selection.



- After selecting a **Load type**, the **Load** list normally only contains **User defined**. When combined with another physics interface that can provide this type of load, it is also possible to choose a predefined load from this list.
- For **Total force**, COMSOL Multiphysics divides the total force by the volume of the domains where the load is active.

LOAD TYPE	VARIABLE	SI UNIT
Load defined as force per unit volume	F_V	N/m^3
Total force	F_{tot}	N



- You can add the [Phase](#) subnode to specify the phase of this load in a frequency domain analysis.

LOCATION IN USER INTERFACE

Context Menus

Solid Rotor>Volume Forces>Body Load

Ribbon

Physics tab with **Solid Rotor** selected:

Domains>Volume Forces>Body Load

Gravity

When you add a **Gravity** node, gravity forces are applied to all selected features in the physics interface with a density, mass, or mass distribution. Here, you select domains, and all objects with a lower dimensionality that belong to the selection are also automatically included.

The gravitational load acts in a fixed spatial direction. The load intensity is $\mathbf{g} = \rho g \mathbf{e}_g$, where g as a default is the acceleration of gravity (a predefined physical constant). Therefore, in the frame of the rotor, it appears as a rotating load and is modeled as so. In stationary analysis, only the component of the gravity along the axis of the rotor is used. The action of gravity can also be seen as a linearly accelerated frame of reference.

COORDINATE SYSTEM SELECTION

The **Global coordinate system** is selected by default. The **Coordinate system** list contains any additional coordinate systems that the model includes. It can be used when prescribing the direction of the gravitational forces.

GRAVITY

Enter the components of the **Gravity g**. The default value is `g_const`, which is the physical constant with a value of 9.8066 m/s².

LOCATION IN USER INTERFACE

Context Menus

Solid Rotor>Volume Forces>Gravity

Ribbon

Physics tab with **Solid Rotor** selected:

Domains>Volume Forces>Gravity

Boundary Load

Use a **Boundary Load** to apply traction or pressure to boundaries.

FRAME TYPE

Select a **Frame type** — **Spatial**, or **Corotating** to specify the load in the appropriate frame.



- Since the rotor is modeled in a rotating frame, a stationary load in a **Corotating** frame works as a stationary load in the model. A stationary load in the **Spatial** frame will, however, change its direction with the angular velocity of the rotor, and therefore acts as a time-dependent load in the model.
- For a frequency domain analysis, a load in the **Spatial** frame is phase shifted to give the effect of rotation.
- For a stationary analysis, **Frame type** has no influence on the analysis. .

FORCE

Select a **Load type** — **Load defined as force per unit area**, **Pressure**, or **Total force**. Then enter values or expressions for the load components based on the selection.

- For **Load defined as force per unit area**, you can define a distributed force over the selected boundary.
- For **Total force**, COMSOL Multiphysics then divides the total force by the area of the surfaces where the load is active.
- For **Pressure**, a scalar input is given, and the orientation of the load is given by the normal to the boundary. The pressure is positive when directed toward the solid.



After selecting a **Load type**, the **Load** list normally only contains **User defined**. When combined with another physics interface that can provide this type of load, it is also possible to choose a predefined load from this list.

LOAD TYPE	VARIABLE	SI UNIT
Load defined as force per unit area	F_A	N/m^2
Total force	F_{tot}	N
Pressure	p	Pa



- You can add the [Phase](#) subnode to specify the phase of this load in a frequency domain analysis.
-

LOCATION IN USER INTERFACE

Context Menus

Solid Rotor>Boundary Load

Ribbon

Physics tab with **Solid Rotor** selected:

Boundaries>Solid Rotor>Boundary Load

Applied Torque

Add an **Applied Torque** node to prescribe a torque acting on a cross section of the rotor. The selection should be a set of boundaries representing a cross section.

TORQUE

Enter the torque around the rotor axis, T_{ax} . The positive orientation is the same as the rotor axis.

LOCATION IN USER INTERFACE

Context Menus

Solid Rotor>Applied Torque

Ribbon

Physics tab with **Solid Rotor** selected:

Boundaries>Solid Rotor>Applied Torque

Added Mass

The **Added Mass** node is available on domains and boundaries and can be used to supply inertia that is not part of the rotor itself but is attached to the rotor. Therefore, inertial forces from this feature also take into account the effect of the rotation about the rotor axis. Such inertia does not need to be isotropic, in the sense that the inertial effects are not the same in all directions. It also adds the effect of acceleration due to gravity if the gravity feature is added in the current domain for the domain feature or in the neighboring domains for the boundary feature

COORDINATE SYSTEM SELECTION

The added mass values are given with respect to the selected coordinate directions.

ADDED MASS

Select a **Mass type** using [Table 4-1](#) as a guide. The default option is the type for the geometric entity. The added mass matrix can be entered as **Isotropic**, **Diagonal**, or **Symmetric**. For **Isotropic**, the same mass is used in all the diagonal elements of the mass matrix.

TABLE 4-1: AVAILABLE MASS TYPES BASED ON GEOMETRIC ENTITY

MASS TYPE	VARIABLE	SI UNITS	GEOMETRIC ENTITY LEVEL
Mass per unit volume	ρ_V	kg/m^3	domains
Mass per unit area	ρ_A	kg/m^2	boundaries
Total mass	m	kg	domains, boundaries

LOCATION IN USER INTERFACE

Context Menus

Solid Rotor>Added Mass (Domain, Boundary)

Ribbon

Physics tab with **Solid Rotor** selected:

Domains>Added Mass

Boundaries>Added Mass

Spur Gear

Use the **Spur Gear** node to model a spur gear. The gear is assumed to be rigid. Select one or more domains to make them a part of the gear.

A spur gear can be connected to another **Spur Gear**, or a **Helical Gear** through the **Gear Pair** node. Two gears can be connected to each other only if they satisfy the [Gear Pair Compatibility Criteria](#).

The gear has the following subnodes to constraint the displacement and rotation, to apply forces and moments, and to add mass and moment of inertia:



These subnodes are described in the *Structural Mechanics Module User's Guide*:

- [Fixed Constraint \(Rigid Domain\)](#)
- [Prescribed Displacement/Rotation](#)
- [Applied Force \(Rigid Domain\)](#)
- [Applied Moment \(Rigid Domain\)](#)
- [Mass and Moment of Inertia \(Rigid Domain\)](#)

SKETCH

This section shows a sketch of a spur gear. Some of the inputs are also highlighted in the sketch.

GEAR PROPERTIES

Specify the properties of a spur gear in this section.

- Select the **Gear mesh** — **External** or **Internal**.
- Enter **Number of teeth** n .
- Enter **Pitch diameter** d_p .
- Enter **Pressure angle** α .

GEAR AXIS

The gear axis is defined as the axis of rotation of the gear. The gear axis is defined as the axis of rotation of the gear. To define the axis, choose **Specify direction** or **Select a parallel edge**.

- For **Specify direction**, enter a value or expression for \mathbf{e}_g . The default is (0, 0, 1). The direction is specified in the selected coordinate system.
- For **Select a parallel edge**, an edge can be selected on the [Gear Axis](#) subnode, which is added automatically. The vector from the first to last end of the edge is used to define the gear axis. Any edge in the model can be used. Select the **Reverse direction** check box to reverse the direction of the gear axis.

DENSITY

The default **Density** ρ is taken **From material**. In this case, the material assignment for the domain supplies the mass density. For **User defined** enter another value or expression.



The density is needed for dynamic analysis. It is also used when computing mass forces for gravitational or rotating frame loads, and when computing mass properties ([Computing Mass Properties](#)).

CENTER OF ROTATION

The center of rotation is the point about which the rotation of the gear is interpreted. Select an option from the list — **Center of mass**, **Centroid of selected entities**, or **User defined**.

- For **User defined**, enter the coordinates of center of rotation \mathbf{X}_c in the global coordinate system.
- For **Centroid of selected entities**, select an **Entity level** — **Boundary**, **Edge** (3D components), or **Point**.



Once chosen, a default **Center of Rotation: Boundary**, **Center of Rotation: Edge**, or **Center of Rotation: Point** subnode is added.



[Spur Gear Theory](#)

LOCATION IN USER INTERFACE

Context Menus

Solid Rotor>Gears>Spur Gear

Ribbon

Physics tab with **Solid Rotor** selected:

Domains>Gears>Spur Gear

Helical Gear

Use the **Helical Gear** node to model a helical gear. The gear is assumed to be rigid. Select one or more domains to make them a part of the gear.

A helical gear can be connected to another **Helical Gear**, or a **Spur Gear** through the **Gear Pair** node. Two gears can be connected to each other only if they satisfy the **Gear Pair Compatibility Criteria**.

GEAR PROPERTIES

Specify the properties of a helical gear in this section.

- Select the **Gear mesh** — **External** or **Internal**.
- Enter **Number of teeth** n .
- Enter **Pitch diameter** d_p .
- Enter **Pressure angle** α .
- Enter **Helix angle** β .



See **Spur Gear** for the list of subnodes and the following settings — **Sketch**, **Gear Axis**, **Density**, **Center of Rotation**, and **Initial Values**.



[Helical Gear Theory](#)

LOCATION IN USER INTERFACE

Context Menus

Solid Rotor>Gears>Helical Gear

Ribbon

Physics tab with **Solid Rotor** selected:

Domains>Gears>Helical Gear

Bevel Gear

Use the **Bevel Gear** node to model a bevel gear. The gear is assumed to be rigid. Select one or more domains to make them a part of the gear.

A bevel gear can be connected to another **Bevel Gear** through the [Gear Pair](#) node. Two bevel gears can be connected to each other only if they satisfy the [Gear Pair Compatibility Criteria](#).

GEAR PROPERTIES

Specify the properties of a bevel gear in this section.

- Enter **Number of teeth** n .
- Enter **Pitch diameter** d_p .
- Enter **Pressure angle** α .
- Enter **Cone angle** γ .



See [Spur Gear](#) for the list of subnodes and the following settings — **Sketch**, **Gear Axis**, **Density**, **Center of Rotation**, and **Initial Values**.



[Bevel Gear Theory](#)

LOCATION IN USER INTERFACE

Context Menus

Solid Rotor>Gears>Bevel Gear

Ribbon

Physics tab with **Solid Rotor** selected:

Domains>Gears>Bevel Gear

Gear Axis

Use the **Gear Axis** node to select any edge in the geometry that is parallel to the axis of rotation of the gear.

This setting is available for the [Spur Gear](#), [Helical Gear](#), and [Bevel Gear](#) nodes.

LOCATION IN USER INTERFACE

This node is automatically added when **Select a parallel edge** is selected in the parent gear node. It cannot be added or removed manually.

Initial Values (Gear)

The **Initial Values** subnode is automatically added to the [Spur Gear](#), [Helical Gear](#), and [Bevel Gear](#) nodes.

You can enter initial values for the rigid body displacement, rotation, and velocities, which can serve as an initial condition for a transient simulation or as an initial guess for a nonlinear analysis. The initial values that you specify are interpreted in the selected coordinate system.

CENTER OF ROTATION

Select an option from the list — **From Parent**, or **Centroid of selected entities**, or **User defined**.

- For **Centroid of selected entities**, select an **Entity level** — **Boundary**, **Edge**, or **Point**.
- For **User defined**, in the table, enter the **Global coordinates of center of rotation** \mathbf{X}_c .



Once chosen, a default [Center of Rotation: Boundary](#), [Center of Rotation: Edge](#), or [Center of Rotation: Point](#) subnode is added.

INITIAL VALUES: TRANSLATIONAL

- **Displacement at center of rotation** \mathbf{u} .
- **Velocity at center of rotation** $\partial\mathbf{u}/\partial t$.

INITIAL VALUES: ROTATIONAL

- **Axis of rotation** Ω
- **Angle of rotation** ϕ .
- **Angular velocity** ω .



See the [Rigid Domain Model](#) section in the *Structural Mechanics Module User's Guide* for more information.

LOCATION IN USER INTERFACE

This node is automatically added to the [Spur Gear](#), [Helical Gear](#), and [Bevel Gear](#) nodes. It cannot be added or removed manually.

Gear Pair

Use the **Gear Pair** node to create a connection between gears of the types [Spur Gear](#), [Helical Gear](#), or [Bevel Gear](#) in such a way that, at the contact point, they have no relative motion along the line of action. The remaining displacements and rotations of both the gears are independent of each other.

If the **Line contact** option is chosen in the **Contact model**, one additional constraint is added at the contact point to restrict the relative rotation about a line joining the two gear centers.

When **Friction** is included for a gear pair, frictional forces in the plane perpendicular to the line of action are added on both the gears.

SKETCH

This section shows a sketch of a gear pair. The sketch highlights the coordinate system attached to both the gears, the coordinate system attached to the gear tooth, the line of action, and other relevant input parameters.

GEAR SELECTION

Select **Wheel** and **Pinion** from the list of gears. You can select any [Spur Gear](#), [Helical Gear](#), or [Bevel Gear](#) node that is defined for the model.

LINE OF ACTION

Define the line of action by specifying **Obtained by rotation of tangent in — Clockwise direction**, or **Counterclockwise direction**.

Select the **Clockwise direction** option in the following cases:

- **Wheel** is the driver and the **Wheel** has positive rotation about its own axis.
- **Pinion** is the driver and the **Wheel** has negative rotation about its own axis.

Select the **Counterclockwise direction** option in the following cases:

- **Pinion** is the driver and the **Wheel** has positive rotation about its own axis.
- **Wheel** is the driver and the **Wheel** has negative rotation about its own axis.

The gear pair sketch in the **Sketch** section is updated based on the selection and shows the line of action for both cases.

CONTACT MODEL

Define the contact model for a gear pair in this section.

- Select the **Configuration** — **Parallel or intersecting** or **Neither parallel nor intersecting**. The **Configuration** is always set to **Parallel or intersecting** for spur and bevel gears. For helical gears, you can select the **Configuration** as **Parallel or intersecting** (for parallel axis helical gears) or **Neither parallel nor intersecting** (for crossed axis helical gears).
- For **Parallel or intersecting**, select the **Contact model** — **Point contact**, or **Line contact**. For **Neither parallel nor intersecting** the **Contact model** is always set to **Point contact**.
- For **Parallel or intersecting**, enter **Contact point offset from pinion center** z_{pn} . For **Neither parallel nor intersecting** it is automatically computed.
- For **Line contact**, enter **Working width of pinion** w_{pn} .

GEAR PAIR PROPERTIES

Define the advanced properties for a gear pair in this section.

- Select **Include gear elasticity** to enter the gear mesh stiffness, mesh damping, and the contact ratio. These properties can be entered in the [Gear Elasticity](#) subnode, which is added automatically. By default, this option is not selected.
- Select **Include transmission error** to enter the static transmission error for individual gears or for the gear pair. These can be entered in the [Transmission Error](#) subnode, which is added automatically. By default, this option is not selected.
- Select **Include backlash** to enter backlash in a gear pair. This can be entered in the [Backlash](#) subnode, which is added automatically. By default, this option is not selected.
- Select **Include friction** to add friction at the contact point. Enter frictional properties in the [Friction \(Gear\)](#) subnode, which is added automatically. By default, this option is not selected.

CONTACT FORCE COMPUTATION

Select an option from the list to use the method of computation for the forces at the contact point — **Computed using weak constraints**, or **Computed using penalty method**. Alternatively, you can also choose **Do not compute**.

For **Computed using penalty method**, enter **Penalty factor** p_c . The default value is $((1[1/ms])^2)*rotsld.grp1.me$. The exact naming of the variable depends on the tags of the nodes in the model tree.



LOCATION IN USER INTERFACE

Context Menus

Solid Rotor>Gear Pairs>Gear Pair

Ribbon

Physics tab with **Solid Rotor** selected:

Global>Gear Pairs>Gear Pair

Gear Elasticity

The **Gear Elasticity** subnode is automatically added to a **Gear Pair** node when **Include gear elasticity** is selected under **Gear Properties**. In this node, you can enter the elastic properties of a gear pair, such as gear mesh stiffness, mesh damping, and contact ratio.

The contents of the **Gear Elasticity** settings adapt to the type of gear pair where it is used.

SKETCH

This section shows a sketch of the contact point of gear pair in the gear tooth normal plane. The sketch highlights the line of action along which stiffness and damping are interpreted.

MESH STIFFNESS

Select the mesh stiffness method **Specify** — **Tooth stiffness of individual gears**, or **Total stiffness of gear pair**.

For **Tooth stiffness of individual gears**, enter the following:

- Enter **Wheel tooth stiffness as function of mesh cycle**, $k_{t,wh}$, and **Pinion tooth stiffness as function of mesh cycle**, $k_{t,pn}$. The default expressions are $(0[N/m])*rotsld.grp1.thm_wh$ and $(0[N/m])*mbd.rotsld.thm_pn$

respectively. The exact naming of the variables depends on the tags of the nodes in the model tree.

- Specify **Contact ratio in mesh cycle** — **Constant** or **Varying**.
- For **Constant** contact ratio, select **Contact ratio** — **1**, **2**, or **3**.
- For **Varying** contact ratio, select **Maximum contact ratio** — **2**, or **3**. Also enter the **Next tooth engagement position in mesh cycle**, ζ . The value of ζ must vary between 1/2 and 1 when **Maximum contact ratio** is set to **2** and between 1/3 to 1/2 when **Maximum contact ratio** is set to **3**.

For **Total stiffness of gear pair**, enter the following:

- Select the **Total stiffness as function of** — **Wheel mesh cycle**, **Wheel full revolution**, **Pinion mesh cycle**, or **Pinion full revolution**.
- Enter **Total stiffness**, k_g . The default expression of total stiffness depends on the selection in previous input (for example, it is $(0[\text{N/m}]) * \text{rots1d.grp1.thm_wh}$ when **Wheel mesh cycle** is selected). The exact naming of the variable depends on the tags of the nodes in the model tree.

MESH DAMPING

Enter **Mesh damping**, c_g . The mesh damping can be specified as proportional to the mesh stiffness. The default expression is $(0[\text{s}]) * \text{rots1d.grp1.kg}$. The exact naming of the variable depends on the tags of the nodes in the model tree.



Theory for Gear Elasticity

LOCATION IN USER INTERFACE

This node is automatically added when **Include gear elasticity** is selected in the parent **Gear Pair** nodes. It cannot be added or removed manually.

Transmission Error

The **Transmission Error** subnode is automatically added to a **Gear Pair** node when **Include transmission error** is selected under **Gear Properties**. The static transmission error for individual gears or for a gear pair can be entered in this node.

SKETCH

This section shows a sketch of the contact point of a gear pair in the gear tooth normal plane. The sketch highlights the line of action along which transmission error is interpreted.

TRANSMISSION ERROR

Select the transmission error method **Specify** — **Transmission error of individual gears**, or **Transmission error of gear pair**.

For **Transmission error of individual gears**, enter the following:

Select the **Wheel transmission error as function of** — **Mesh cycle**, or **Full revolution** and enter **Wheel transmission error** e_{wh} . Similarly, select the **Pinion transmission error as function of** — **Mesh cycle**, or **Full revolution** and enter **Pinion transmission error** e_{pn} .

The default expression of transmission errors depend on the selection in previous input (for example, the default expression of **Wheel transmission error** is $(0[m]) * \text{rots1d.grp1.thm_wh}$ when **Mesh cycle** is selected). The exact naming of the variable depends on the tags of the nodes in the model tree.

For **Transmission error of gear pair**, enter the following:

Select the **Transmission error as function of** — **Wheel mesh cycle**, **Wheel full revolution**, **Pinion mesh cycle**, or **Pinion full revolution**.

Enter **Total transmission error**, e_t . The default expression of total transmission error depends on the selection in previous input (for example, it is $(0[m]) * \text{rots1d.grp1.thm_wh}$ when **Wheel mesh cycle** is selected). The exact naming of the variable depends on the tags of the nodes in the model tree.



[Theory for Transmission Error](#)

LOCATION IN USER INTERFACE

This node is automatically added when **Include transmission error** is selected in the parent [Gear Pair](#) node. It cannot be added or removed manually.

Backlash

The **Backlash** subnode is automatically added to a [Gear Pair](#) node when **Include backlash** is selected under **Gear Properties**.



Backlash can only be specified on a gear pair in a time-dependent analysis.

SKETCH

This section shows a sketch of the contact point of gear pair in the gear tooth normal plane. The sketch highlights the direction in which backlash is interpreted.

BACKLASH

- Enter **Backlash** b_1 .
- Enter **Penalty factor** p_b . The default expression is $((1/[1/\text{ms}]^2) * \text{rotsld.grp1.Ie})$. The exact naming of the variable depends on the tags of the nodes in the model tree.

ADVANCED

- Select **Manual control on time stepping** to restrict the maximum time step taken by the solver when there is finite penetration.
- Enter **Maximum allowable time step** Δt_{max} . The default expression is $(\pi/30) * (\text{sqrt}(\text{rotsld.grp1.Ie}/\text{rotsld.grp1.pb}))$. The exact naming of the variables depends on the tags of the nodes in the model tree.



[Theory for Backlash](#)

LOCATION IN USER INTERFACE

This node is automatically added when **Include backlash** is selected in the parent [Gear Pair](#) node. It cannot be added or removed manually.

Friction (Gear)

The **Friction** subnode is automatically added to a [Gear Pair](#) node when **Include friction** is selected under **Gear Properties**. Use this node to model friction losses on a gear pair.



Friction can only be applied to a gear pair in a time-dependent analysis.

FRICITION

- Enter a **Frictional coefficient** μ .
- Enter a **Characteristic slip velocity** v_0 . The default is `mbd.diag*(1e-3[1/s])`, where the `mbd.diag` variable contains the diagonal of the bounding box of the geometry. The characteristic slip velocity should be small when compared to the actual slip velocity at the contact point. It is the velocity with which the contact surfaces slide, even under sticking conditions.

NORMAL FORCE

- Specify **Normal force defined through** — **Contact force** or **User defined force**. For **Contact force** option, it is required that contact force is computed on the parent **Gear Pair** node.
- For the **User defined force** option, enter **Normal force** N .

ADVANCED

Enter values or expressions for the:

- **Additional sliding resistance** $F_{f,r}$.
 - **Maximum friction force** $F_{f,max}$. The default is `Inf`, which means that no upper limit is imposed on the friction force.
-





[Theory for Gear Friction](#)

LOCATION IN USER INTERFACE

This node is automatically added when **Include friction** is selected in the parent [Gear Pair](#) node. It cannot be added or removed manually.

Beam Rotor

This chapter describes the Beam Rotor interface () and its functionality, which is found under the **Structural Mechanics>Rotordynamics** branch () when adding a physics interface.

In this chapter:

- [Beam Rotor Theory](#)
- [The Beam Rotor Interface](#)

Beam Rotor Theory

The first sections of this chapter introduce you to theory that is specific to the Beam Rotor interface features:

- [Displacement, Velocity, and Acceleration](#)
- [Implementation](#)
- [Disk](#)

Displacement, Velocity, and Acceleration

This section aims at defining the displacement, the rotation field, and corresponding velocity and acceleration of a point on the rotor. Since a line geometry is used to represent the rotor in the Beam Rotor interface, this line itself represents the axis of the rotor. Each point on the line represents the centroid of the cross section as shown in Figure 5-1.

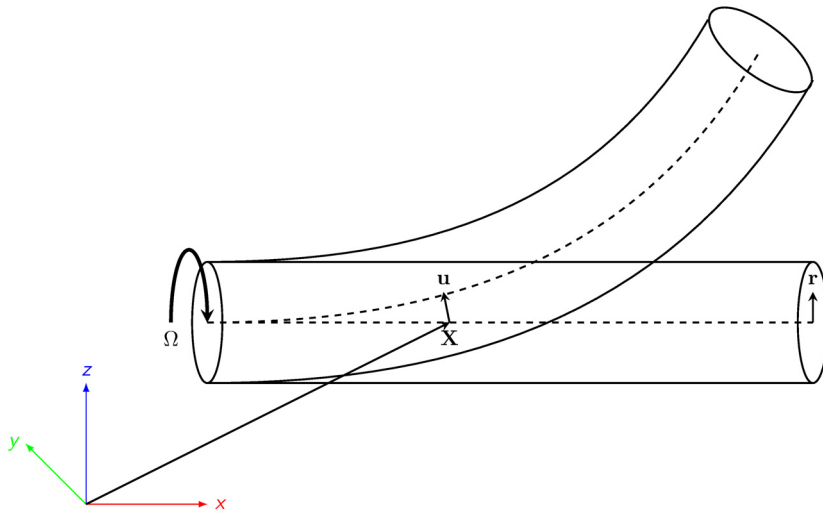

Figure 5-1: Geometric representation of the rotor

Assume that \mathbf{u} and θ are the displacement and deformational rotations of the centroid of the rotor cross section in the spatial frame. Let \mathbf{X} be the material position of a point on the centroid of the rotor. Then, the current position of a point on the rotor can be written as

$$\mathbf{x} = \mathbf{X} + \mathbf{u} + R_{\theta}(R\mathbf{r}) \quad (5-1)$$

where R_{θ} is the rotation matrix due to the rotor deformation, and R is the rotation matrix corresponding to the axial rotation of the rotor. The sequence of the rotations is such that first the cross section of the rotor rotates with the rigid rotation corresponding to the axial rotation of the rotor, followed by the deformational

rotation due to bending and twisting of the rotor. Therefore, components of the rotation vector corresponding to deformational rotation of the rotor are observed in the fixed frame. In the corotating frame, \mathbf{r} is the radial vector from the centroid to an arbitrary point in the cross section. The velocity of the point can be obtained by taking the time derivative of Equation 5-1:

$$\frac{\partial \mathbf{x}}{\partial t} = \frac{\partial \mathbf{u}}{\partial t} + \frac{\partial R_\theta}{\partial t} (R\mathbf{r}) + R_\theta \left(\frac{\partial R}{\partial t} \mathbf{r} \right) = \frac{\partial \mathbf{u}}{\partial t} + R_\theta \left(\frac{\partial \vartheta}{\partial t} + \tilde{\Omega} \right) R\mathbf{r}$$

where $\frac{\partial \vartheta}{\partial t}$ is the skew-symmetric tensor corresponding to the angular velocity vector $\frac{\partial \vartheta}{\partial t}$ of R_θ , and $\tilde{\Omega}$ is the skew-symmetric tensor corresponding to the angular velocity vector Ω of R . Here, since $\tilde{\Omega}$ is premultiplied with the rotation matrix to get the time derivative of the rotation matrix, it is the spin tensor observed in the spatial frame.

The acceleration is then

$$\frac{\partial^2 \mathbf{x}}{\partial t^2} = \frac{\partial^2 \mathbf{u}}{\partial t^2} + R_\theta \left(\frac{\partial^2 \vartheta}{\partial t^2} + \left(\frac{\partial \vartheta}{\partial t} \right)^2 + 2 \frac{\partial \vartheta}{\partial t} \tilde{\Omega} + \frac{\partial \tilde{\Omega}}{\partial t} + \tilde{\Omega}^2 \right) R\mathbf{r} \quad (5-2)$$

Implementation

Due to the frame acceleration in the rotor, inertial contributions to the virtual work are obtained by considering:

$$\delta W = -\int_V \rho \left(\frac{\partial^2 \mathbf{x}}{\partial t^2} \cdot \delta \mathbf{x} \right) dV$$

The variation of the position using Equation 5-1 is

$$\delta \mathbf{x} = \delta \mathbf{u} + \delta R_\theta R \mathbf{r} = \delta \mathbf{u} + R_\theta \delta \vartheta R \mathbf{r}$$

Using this equation and the acceleration from Equation 5-2, the inertial contribution to the virtual work is

$$\delta W = \int_V \rho \left(\left\{ \frac{\partial^2 \mathbf{u}}{\partial t^2} + R_\theta \left(\frac{\partial^2 \vartheta}{\partial t^2} + \left(\frac{\partial \vartheta}{\partial t} \right)^2 + 2 \frac{\partial \vartheta}{\partial t} \tilde{\Omega} + \frac{\partial}{\partial t} \tilde{\Omega} + \tilde{\Omega}^2 \right) R \mathbf{r} \right\} \cdot (\delta \mathbf{u} + R_\theta \delta \vartheta R \mathbf{r}) \right) dV$$

The integration over volume can be split into an integration over the cross-sectional area followed by integration over the length. By using the fact that

$$\int_A \mathbf{r} dA = \mathbf{0},$$

the contribution to the virtual work is simplified to

$$\delta W = -\int_L \rho \left(A \left(\frac{\partial^2 \mathbf{u}}{\partial t^2} \cdot \delta \mathbf{u} \right) + \delta \vartheta \cdot \left\{ I_\Omega \left(\frac{\partial^2 \vartheta}{\partial t^2} + \frac{\partial \Omega}{\partial t} \right) - \Omega \times \left[E_\Omega \left(\Omega + 2 \frac{\partial \vartheta}{\partial t} \right) \right] - \frac{\partial \vartheta}{\partial t} \times E_\Omega \frac{\partial \vartheta}{\partial t} \right\} \right) dL$$

where

$$I_\Omega = \int_A [(\mathbf{Rr}) \cdot (\mathbf{Rr}) I - (\mathbf{Rr}) \otimes (\mathbf{Rr})] dA$$

and

$$E_{\Omega} = \int_A (\mathbf{R}\mathbf{r}) \otimes (\mathbf{R}\mathbf{r}) dA = \frac{1}{2} \text{Trace}(I_{\Omega}) - I_{\Omega}$$

For a geometrically linear formulation, $\vartheta \approx \theta$, and higher-order terms in θ can be dropped. Then, the inertial contribution to the virtual work can be further simplified to

$$\delta W = -\int_L \rho \left[A \left(\frac{\partial^2 \mathbf{u}}{\partial t^2} \cdot \delta \mathbf{u} \right) + \delta \theta \cdot \left\{ I_{\Omega} \left(\frac{\partial^2 \theta}{\partial t^2} + \frac{\partial \Omega}{\partial t} \right) - \Omega \times \left[E_{\Omega} \left(\Omega + 2 \frac{\partial \theta}{\partial t} \right) \right] \right\} \right] dL$$



Due to the rotation of the rotor, the principal directions of the rotor cross section change orientation in the spatial frame. Therefore, all the strain and stress components are defined in the current principal directions of the cross sections.



For details about stresses, strains, and strain energy contributions to the virtual work, see

- [Strain-Displacement/Rotation Relation](#)
- [Stress-Strain Relation](#)
- [Implementation](#)

in the [Theory for the Beam Interface](#) chapter of the *Structural Mechanics Module User's Guide*.

Disk

Disk features represent different types of mounting on the main rotor and are mainly used to provide inertial information of these mountings. These features will affect the dynamics of the rotor. Typical examples of mountings include flywheels, pulleys, gears, impellers, and rotor-blade assemblies. Mounting offset is also accounted for in modeling the inertial effects. Therefore, mass, moment of inertia, and offset are the inputs for this feature. If the moment of inertia is specified about the center of mass of the mounting, which has an offset from the mounting point, then the moment of inertia tensor about the mounting point is given by

$$I = I_{cg} + m\{(\mathbf{r}_{off} \cdot \mathbf{r}_{off})\mathbf{I} - (\mathbf{r}_{off} \otimes \mathbf{r}_{off})\}$$

where \mathbf{r}_{off} is the vector from the centroid of the mounting to the mounting point on the rotor, and \mathbf{I} is the identity tensor. The center of mass of the mounting can be specified using two methods: relative to the mounting point or by absolute position.

The offset of the mounting point from the center of mass is

$$\mathbf{r}_{off} = -(z_a \mathbf{e}_1 + z_r \cos \phi \mathbf{e}_2 + z_r \sin \phi \mathbf{e}_3),$$

for relative position or

$$\mathbf{r}_{off} = \mathbf{X} - \mathbf{r}_{cg}$$

for absolute position.



The contribution to the virtual work, including the frame acceleration and offset effect, is

$$\begin{aligned} \delta W = & -m \delta \mathbf{u} \cdot \left\{ \frac{\partial^2 \mathbf{u}}{\partial t^2} + \frac{\partial^2 \theta}{\partial t^2} \times R \mathbf{r}_{off} + \left(\Omega + \frac{\partial \theta}{\partial t} \right) \times (\Omega \times R \mathbf{r}_{off}) \right\} - \\ & \delta \theta \cdot \left\{ I_s \left(\frac{\partial \Omega}{\partial t} + \frac{\partial^2 \theta}{\partial t^2} \right) + \Omega \times I_s \Omega - 2\Omega \times E_s \Omega + R \mathbf{r}_{off} \times m \frac{\partial^2 \mathbf{u}}{\partial t^2} \right\} \end{aligned}$$

where I_s is the moment of inertia about the mounting point in the spatial frame and is given by

$$I_s = R I R^T$$

The Beam Rotor Interface

The **Beam Rotor (rotbm)** interface () , found under the **Structural Mechanics>Rotordynamics** branch () when adding a physics interface, is intended for analysis of rotating structural components in 3D modeled using a line geometry. With this interface, you can compute are displacements, velocities, accelerations, and stresses. The **Journal Bearing** and **Thrust Bearing** features provided in this interface can be used to model different types of bearings. You can also model the effect of a bearing mounted on a foundation.

The Linear Elastic Material model is the default material model. It adds the equations for the displacements in a linear elastic rotor and has a Settings window to define the elastic and inertia properties of a material. The equations in this feature also account for the frame acceleration forces due to the rotation of the rotor.

When the **Beam Rotor** interface is added, these default nodes are also added to the **Model Builder — Linear Elastic Material; Rotor Cross Section** (cross-sectional properties of the Rotor domain); **Free** (a boundary condition where boundaries are free, with no loads or constraints); and **Initial Values**. The **Fixed Axial Rotation** (a reference point where the axial rotation relative to the rigid rotation of the rotor is zero), is the default node and is only added when the **No torsion** check box is not selected in the interface's **Axial and Torsional Vibration** section.

From the **Physics** toolbar, you can add features that implement other rotor properties. You can also right-click **Beam Rotor** to select physics features from the context menu.

SETTINGS

The **Label** is the default physics interface name.

The **Name** is used primarily as a scope prefix for variables defined by the physics interface. Refer to such physics interface variables in expressions using the pattern <name>. <variable_name>. In order to distinguish between variables belonging to different physics interfaces, the name string must be unique. Only letters, numbers, and underscores (_) are permitted in the **Name** field. The first character must be a letter.

The default **Name** (for the first physics interface in the model) is **rotbm**.

ROTOR SPEED

Enter the **rotor speed** as revolutions per time or angular velocity (variable $0v$). This speed, together with the rotor axis, is then used to compute the frame acceleration forces due to rotation of the rotor.

AXIAL AND TORSIONAL VIBRATION

Clear the **No torsion** check box (selected by default) to include the torsional vibration in the rotor. Similarly, clear the **No axial vibration** check box (selected by default) to also include the axial vibration in the rotor model.

RESULTS

Clear the **Include the undeformed geometry in stress/whirl plot** (selected by default) to avoid plotting the undeformed geometry in the stress and whirl plots.

REFERENCE POINT FOR MOMENT COMPUTATION

Enter the coordinates for the **Reference point for moment computation** \mathbf{x}_{ref} (variable `refpnt`). The resulting moments (applied or as reactions) are then computed relative to this reference point. During the results and analysis stage, the coordinates can be changed in the **Parameters** section in the result nodes.

DEPENDENT VARIABLES

The Beam Rotor interface includes the following dependent variables (fields):

- The displacement field \mathbf{u} , which has three components (u , v , and w).
- The rotation angle θ , which also has three components (thx , thy , and thz).

The names can be changed, but the names of fields and dependent variables must be unique within a model.

DISCRETIZATION

The discretization cannot be changed. The element has different shape functions for the axial and transversal degrees of freedom. The axial displacement and twist are represented by linear shape functions, while the bending is represented by a cubic shape function (Hermitian element).



- [Domain, Boundary, and Pair Nodes for the Beam Rotor Interface](#)
 - [Beam Rotor Theory](#)
-

Domain, Boundary, and Pair Nodes for the Beam Rotor Interface

The **Beam Rotor Interface** has the following edge, point, and pair nodes (and subnodes), listed in alphabetical order, and available from the **Physics** ribbon toolbar (Windows users), **Physics** context menu (Mac or Linux users), or by right-clicking the main physics interface node to access the context menu (all users).

FEATURES AVAILABLE FROM SUBMENUS

Many features for the Beam Rotor interface are added from submenus in the Physics toolbar groups or context menu (when you right-click the node). The submenu name is the same in both cases.

The submenu at the **Edge** level (3D) is:

- **Line Constraints.**

The submenus at the **Point** level are

- **More Constraints**
- **Pairs**

LINKS TO FEATURE NODE INFORMATION

These nodes (and subnodes) are described in the following section (listed in alphabetical order):

- [Disk](#)
- [Edge Load](#)
- [Fixed Axial Rotation](#)
- [Journal Bearing](#)
- [Point Load](#)
- [Radial Roller Bearing](#)
- [Rotor Coupling](#)
- [Rotor Cross Section](#)
- [Squeeze Film Damper](#)
- [Thrust Bearing](#)

These nodes are described for the Beam and Solid Mechanics Interfaces:

- [Edge Load](#)
- [Gravity](#)
- [External Stress](#)
- [Initial Stress and Strain](#)
- [Initial Values](#)
- [Linear Elastic Material](#)
- [Point Load](#)
- [Thermal Expansion \(for Materials\)](#)

These nodes are described for the Solid Rotor interface:

- [Damping](#)
- [Flexible Foundation](#)
- [Misalignment](#)
- [Moving Foundation](#)



In the *COMSOL Multiphysics Reference Manual* see [Table 2-4](#) for links to common sections and [Table 2-5](#) to common feature nodes. You can also search for information: press F1 to open the **Help** window or Ctrl+F1 to open the **Documentation** window.



In general, to add a node, go to the **Physics** toolbar, no matter what operating system you are using. Subnodes are available by clicking the parent node and selecting it from the **Attributes** menu.



The links to the nodes described in external guides, such as the *Structural Mechanics Module User's Guide*, do not work in the PDF, only from the online help in COMSOL Multiphysics.

Initial Values

The **Initial Values** node adds initial values for the displacement field, the velocity field, the rotations, and the angular velocity. These values serve as initial conditions for a transient simulation or as an initial guess for a nonlinear analysis. In addition to the default **Initial Values** node always present in the interface, you can add more **Initial Values** nodes as needed.

INITIAL VALUES

Enter values or expressions for the following based on space dimension:

- **Displacement field** \mathbf{u}
- **Velocity field** $\frac{d\mathbf{u}}{dt}$
- **Rotation field** θ
- **Angular velocity** $\frac{d\theta}{dt}$

Context Menus

Beam Rotor>Initial Values

Beam Rotor>Edges>Initial Values

Ribbon

Physics tab with **Beam Rotor** selected:

Edges>Beam Rotor>Initial Values

Rotor Cross Section

In the **Rotor Cross Section** node, you specify the geometric properties of the rotor's cross section. In addition, some stress evaluation properties can be defined.

SECTION ORIENTATION

In this section, you specify the orientation of the principal axes of the section. Enter the **Orientation vector defining local y direction** in the matrix.



This is required input data.



- [Common Cross Sections](#)
 - [Cross Section Data](#)
-

CROSS SECTION DEFINITION

The default cross section definition is **Common section**, with the **Section type** set to **Circular**. You can also choose a **Pipe** section. Select **User defined** if the rotor cross section does not match any of the predefined section types, or if the cross-section data is directly known.

For **User defined**, go to [Basic Section Properties](#) and [Stress Evaluation Properties](#) to continue defining the cross section.

For **Common sections** select a **Section type** — **Circular**, or **Pipe**. Then go to the relevant section below to continue defining the section. Each **Section type** also has a figure showing the section and its defining dimensions.



For equations and a figure see:

- [Circular Section](#)
 - [Pipe Section](#)
-

Circular

Enter a value or expression for the **Diameter** d_o .

Pipe

Enter values or expressions for the following.

- **Outer diameter** d_o
 - **Inner diameter** d_i
-



- [Cross Section Data](#) in the *Beam Interface* chapter in the *Structural Mechanics Module User's Guide*.
-

LOCATION IN USER INTERFACE

Context Menus

Beam Rotor>Rotor Cross Section

Ribbon

Physics tab with **Beam Rotor** selected:

Edges>Beam Rotor>Rotor Cross Section

Fixed Axial Rotation

Use the default **Fixed Axial Rotation** node to select a point on the rotor that can be treated as a reference for the axial rotation of the rotor. This rotation is the twisting rotation of the rotor due to the torsional load.

LOCATION IN USER INTERFACE

Context Menus

Beam Rotor>Fixed Axial Rotation

Ribbon

Physics tab with **Beam Rotor** selected:

Points>Beam Rotor>Fixed Axial Rotation

Disk

Add a **Disk** node to a point on a rotor to model the inertial effects of components attached to the rotor. These components are considered to be rotating with the rotor.

DISK PROPERTIES

Select **Center of mass** — **Selected points**, **Offset from the selected points**, or **User defined**.

This section specifies the location of the center of mass relative to the selected points. Then, go to the relevant section below to continue defining the section.

Selected Points

Select **Disk type** — **Circular** or **Noncircular**.

When the disk type is **Circular**, select **Specified by** — **Mass and moment of inertia** or **Geometric dimensions**. For **Mass and moment of inertia**, enter the mass, m , polar and diametral moment of inertia I_p and I_d of the disk. For **Geometric dimensions**, enter the density, ρ , diameter, d , and thickness, h , of the disk.

When the disk type is **Noncircular**, enter the full moment of inertia tensor about the center of gravity I_{cg} .

Offset from Selected Points

Enter the following offset information:

- **Radial offset**, z_r
- **Offset angle from local y direction**, ϕ
- **Axial offset**, z_a

Subsequently, enter the inertial properties as in the **Selected points** case. The only exception is that in this case, the moment of inertia for the noncircular case can be specified either about **Center of mass** (I_{cg}) or **Selected points** (I).

User Defined Node

Enter the **Position of the center of mass, \mathbf{r}_{cm}** . Subsequently, enter the inertial properties as in the **Offset from selected points** case.



Forces caused by the disk eccentricity rotate with the rotor. In a frequency domain analysis, this is phase shifted to give the effect of rotation.

Journal Bearing

Add a **Journal Bearing** to points corresponding to the journal bearing location for modeling the effect of the bearing. You can select multiple points to add identical bearings at several locations.

If clearance is incorporated, you can also study the effect of misalignment by adding a [Misalignment](#) subnode. [Radial Roller Bearing](#)

BEARING ORIENTATION

Use the settings in this section to define the local y direction of the bearing. Subsequent vector and matrix inputs are specified in the local directions specified here.

Enter the **Bearing orientation vector defining the local y direction**. The direction given will be adjusted so that it is orthogonal to the rotor axis. The default value is the global y -axis.

You can further modify the y -axis orientation by entering an angle for the **Rotation of the orientation vector around the bearing axis**. The direction inferred from the previous setting will be rotated counterclockwise around the rotor axis.

BEARING PROPERTIES

Select a **Bearing Model** — **No clearance, Plain hydrodynamic, Total spring and damping constant**, or **Total force and moment**. Then, go to the relevant section below to continue defining the section.

No Clearance

Clear the **Constrain bending rotation** check box (selected by default) to allow the bending rotation of the rotor at the bearing location.

Plain Hydrodynamic

Enter the **Bulk Viscosity**, μ , of the lubricant; **Clearance**, C , between the journal and bushing; the **Journal radius**, R ; and the **Journal length**, L . For the **Bulk viscosity**, select

From material to use data from a material assigned to the selected journal boundaries, or select **User defined** to enter a value or expression.

These values are used to calculate the stiffness and damping constants by linearization of the total forces and moments obtained with a short bearing approximation in the Reynolds equation.

Clear the **Include bending stiffness** check box to ignore the resistance of the bearing to the bending rotation of the journal.

Total Spring and Damping Constant

Enter the translational and bending stiffness, k_u and k_θ . Select the **Translational-rotational coupling** check box to also model the coupling between the translational and rotational motion of the journal. Enter the values of the additional inputs, $k_{u\theta}$ and $k_{\theta u}$ in this case. If you want to perform dynamic analysis, you can also enter nonzero translational and bending damping constants c_u and c_θ . Select the **Translational-rotational coupling** check box and enter the $c_{u\theta}$ and $c_{\theta u}$ values to include the translational-rotational coupling in damping constants.

Total Force and Moment

Enter the **Total force, \mathbf{F}** and **Total moment, \mathbf{M}** , as a function of journal displacement and rotation. Default expressions are provided as an example of how to specify the forces and moments as a function of journal displacement and rotation. These expressions contain variables of the type `<phys>.<feat>.{du2, du3, dth2, dth3}`, which are the lateral components of the journal displacement and rotation of the journal in the local bearing directions.

If the **No axial vibration** check box in the **Axial and Torsional Vibration** section of the interface settings is not selected, the **Constrain axial motion** check box will be visible. Clear this check box if you want to use the [Thrust Bearing](#) node to restrict the axial motion.

FOUNDATION PROPERTIES

Select one of the **Fixed**, **Moving**, **Flexible**, or **Squeeze film damper** foundation options. In the **Moving**, **Flexible**, and **Squeeze film damper** cases, the subnodes [Moving Foundation](#), [Flexible Foundation](#), or [Squeeze Film Damper](#) are automatically added.

LOCATION IN USER INTERFACE

Context Menus

Beam Rotor>Journal Bearing

Ribbon

Physics tab with **Beam Rotor** selected:

Points>Beam Rotor>Journal Bearing

Thrust Bearing

Add a **Thrust Bearing** node and select a point representing the locations of the thrust bearing.

If clearance is incorporated, you can also study the effect of misalignment by adding a [Misalignment](#) subnode.

BEARING ORIENTATION

Use the settings in this section to define the local y direction of the bearing.

Subsequent vector and matrix inputs are specified in the local directions specified here.

Enter the **Bearing orientation vector defining the local y direction**. The direction given will be adjusted so that it is orthogonal to the rotor axis. The default value is the global y -axis.

You can further modify the y -axis orientation by entering an angle for the **Rotation of the orientation vector around the bearing axis**. The direction inferred from the previous setting will be rotated counterclockwise around the rotor axis.

BEARING PROPERTIES

Select a **Bearing Model** — **No clearance**, **Total spring and damping constant**, or **Total force and moment**. Then, go to the relevant section below to continue defining the properties.

Total Spring and Damping Constant

Enter the axial and bending stiffness, k_u and k_θ . Select the

Translational-rotational coupling check box to also model the coupling between the axial and rotational motion of the collar. Enter expressions for the additional inputs, $k_{u\theta}$ and $k_{\theta u}$ in this case. If you want to perform dynamic analysis, you can also enter the values of the axial and bending damping constants c_u and c_θ . Select the **Translational-rotational coupling** check box and enter $c_{u\theta}$ and $c_{\theta u}$ values to include the translational-rotational coupling in damping constants.

Total Force and Moment

Enter the **Total force**, F_{ax} and **Total moment**, \mathbf{M} , as functions of collar displacement and rotation.

Select the **Constrain lateral motion** check box (cleared by default) if you do not want to use the **Journal Bearing** node to restrict the lateral motion. Default expressions are provided as an example of how to specify the forces and moments as a function of collar displacement and rotation. These expressions contain variables of the type $\langle phys \rangle . \langle feat \rangle . \{ du1, dth2, dth3 \}$, which are the axial component of the collar displacement and lateral components of the collar rotation, respectively, in the local bearing directions.

FOUNDATION PROPERTIES

Select one of the **Fixed**, **Moving**, or **Flexible** foundation options. In the **Moving** and **Flexible** cases, the subnodes **Moving Foundation** or **Flexible Foundation** are automatically added.

LOCATION IN USER INTERFACE

Context Menus

Beam Rotor>Thrust Bearing

Ribbon

Physics tab with **Beam Rotor** selected:

Points>Beam Rotor>Thrust Bearing

Radial Roller Bearing

Add a **Radial Roller Bearing** node and select a point representing the location of the roller bearing.

You can also study the effect of misalignment by adding a **Misalignment** subnode.

BEARING ORIENTATION

Use the settings in this section to define the local y direction of the bearing. Subsequent vector and matrix inputs are specified in the local directions specified here.

Enter the **Bearing orientation vector defining the local y direction**. The direction given will be adjusted so that it is orthogonal to the rotor axis. The default value is the global y -axis.

You can further modify the y -axis orientation by entering an angle for the **Rotation of the orientation vector around the bearing axis**. The direction inferred from the previous setting will be rotated counterclockwise around the rotor axis.

GEOMETRIC PROPERTIES

Select a **Bearing Type** — **Deep groove ball bearing**, **Angular contact ball bearing**, **Self aligning ball bearing**, **Spherical roller bearing**, **Cylindrical roller bearing**, or **Tapered roller bearing**. Then go to the relevant section below to continue defining the properties.

Deep Groove Ball Bearing

Select either of **Single row** or **Double row** to specify if the bearing consists of single or double rows of rollers. For **Double row** bearing, enter the **Axial distance between the roller centers**. Enter the geometric properties **Number of balls**; **Ball diameter**; **Radial clearance**; **Pitch diameter**; **Contour radius, inner race**; and **Contour radius, outer race** to define the bearing geometry.

Angular Contact Ball Bearing

Select either of **Single row** or **Double row** to specify if the bearing consists of single or double rows of rollers. For **Double row** bearing, enter the **Axial distance between the roller centers**. Enter the other geometric properties **Number of balls**; **Ball diameter**; **Radial clearance**; **Pitch diameter**; **Contour radius, inner race**; **Contour radius, outer race**; and **Initial contact angle** to define the bearing geometry.

Self Aligning Ball Bearing

Select either of **Single row** or **Double row** to specify if the bearing consists of single or double rows of rollers. Enter the other geometric properties **Number of balls**, **Ball diameter**, **Radial clearance**, **Pitch diameter**, **Contour radius, inner race**, **Contour radius, outer race** and **Initial contact angle** (only for **Double row** bearing) to define the bearing geometry.

Spherical Roller Bearing

Select either of **Single row** or **Double row** to specify if the bearing consists of single or double rows of rollers. For **Double row** bearing, enter the **Axial distance between the roller centers** and **Initial contact angle**. Enter the other geometric properties **Number of rollers**, **Roller diameter**, **Radial clearance**, **Pitch diameter**, **Contour radius, inner race**, and **Contour radius, outer race** to define the bearing geometry.

Cylindrical Roller Bearing

Select either of **Single row** or **Double row** to specify if the bearing consists of single or double rows of rollers. For **Double row** bearing, enter the **Axial distance between the roller centers**. Enter the other geometric properties **Number of rollers**, **Effective length of the roller**, **Radial clearance** and **Pitch diameter** to define the bearing geometry.

Tapered Roller Bearing

Select either of **Single row** or **Double row** to specify if the bearing consists of single or double rows of rollers. For **Single row** bearing, enter the **Axial offset of roller center**. For **Double row** bearing enter the **Axial distance between the roller centers**. Enter the other geometric properties **Number of rollers**, **Roller diameter**, **Effective length of the roller**, **Inner race clearance**, **Outer race clearance**, **Flange clearance**, **Pitch diameter**, **Cap radius**, **Semi cone angle**, **Roller axis orientation**, **Cap angle**, and **Flange contact angle** to define the bearing geometry.

MATERIAL PROPERTIES

Enter the material properties **Young's modulus, inner race** and **Poisson's ratio, inner race** to define the elastic properties of the inner race in the bearing. Select **Outer race material** — **Same as inner race** or **User defined**. If **User defined** is selected, enter the values of **Young's modulus, outer race** and **Poisson's ratio, outer race**. Finally select **Roller material** — **Same as inner race** or **User defined**. If **User defined** is selected, enter the values of the **Young's modulus, roller/ball** and **Poisson's ratio, roller/ball**.

FOUNDATION PROPERTIES

Select one of the **Fixed**, **Moving**, **Flexible**, or **Squeeze film damper** foundation options. In the **Moving**, **Flexible**, and **Squeeze film damper** cases, the subnodes [Moving Foundation](#), [Flexible Foundation](#), or [Squeeze Film Damper](#) are automatically added.

LOCATION IN USER INTERFACE

Context Menus

Beam Rotor>Radial Roller Bearing

Ribbon

Physics tab with **Beam Rotor** selected:

Points>Radial Roller Bearing

Squeeze Film Damper

The **Squeeze Film Damper** node is added automatically when you set **Foundation properties** to **Squeeze Film Damper** in the parent **Journal Bearing**, or **Radial Roller Bearing** node. In this node, you specify the damper dimensions and lubricant properties to compute the equivalent damping coefficient based on a short bearing length approximation.

DAMPER PROPERTIES

Select **Bulk viscosity** — **From material** or **User defined**. If **User defined**, enter the value of the **Bulk viscosity**, μ . Enter the values of **Clearance**, C , **Journal Radius**, R , and **Journal length**, L . Clear the check box **Include tilting** (selected by default) to exclude the effect of the tilting of the journal in the damper.

CENTERING SPRING

Centering springs are used in squeeze film dampers to allow them to support static loads. Enter the values of **Spring constant**, k_{cs} , and **Damping constant**, c_{cs} , for the centering spring.

LOCATION IN USER INTERFACE

This node is automatically added when **Foundation Properties** is set to **Squeeze Film Damper** in the parent bearing node. It cannot be added or removed manually.

Rotor Coupling

Add a **Rotor Coupling** node to model the coupling characteristics between two rotors. The selection for this feature is a point on the rotor where the coupling is located.

COUPLING PROPERTIES

Select **Coupling type** — **Spline**, **Torsional**, or **User defined**. Then, go to the relevant section below to continue defining the properties.

Spline

No extra input is needed. This coupling type connects the displacement and axial rotation across the two rotors, while keeping the tilting of the rotors uncoupled on interior points. On exterior points, only the axial rotation is fixed.

Torsional

Enter the value of the **Torsional stiffness**, $k_{\theta,ax}$. This coupling type connects displacement and tilting rotations across the two rotors on interior points and axial rotation of both rotors are connected by a spring of stiffness $k_{\theta,ax}$. On exterior points, displacement and tilting rotations are free. The axial rotation is connected by a spring of stiffness $k_{\theta,ax}$ relative to an imaginary fixed point.

User Defined

Select **Displacement connection** — **Rigid** or **Flexible**. In the **Flexible** case, enter the **Translational stiffness**, \mathbf{k}_U . The displacements in the two rotors are connected by a

spring with the specified stiffness. In the **Rigid** case, the displacements in both rotors are rigidly connected. On an exterior point, the other rotor is assumed to be fixed.

Select **Axial rotation connection** — **Flexible** or **Rigid**. In the **Flexible** case, enter the **Torsional stiffness**, $k_{\theta,ax}$. The axial rotation in the two rotors is connected by a torsional spring with the specified stiffness. In the **Rigid** case, the axial rotations in both rotors are rigidly connected. On an exterior point, the other rotor is assumed to be fixed.

Select the **Bending rotation connection** — **Flexible** or **Rigid**. In the **Flexible** case, enter the **Bending stiffness**, $k_{\theta,b}$. The bending rotations in the two rotors are connected by a spring with the specified stiffness. In the **Rigid** case, tilting rotations in both rotors are rigidly connected. On an exterior point, the other rotor is assumed to be fixed.

LOCATION IN USER INTERFACE

Context Menus

Beam Rotor>Rotor Coupling

Ribbon

Physics tab with **Beam Rotor** selected:

Points>Rotor Coupling

Edge Load

Use an **Edge Load** node to apply an edge or body load on the rotor.

FRAME TYPE

Select a **Frame type** — **Spatial**, or **Corotating** to specify the load in the appropriate frame.



- Since the beam rotor is modeled in the spatial frame, a stationary load in a **Corotating** frame works as a rotating load in the model. This load changes its direction with the angular velocity of the rotor. A stationary load in the **Spatial** frame is a true static load for beam rotor.
 - For a frequency domain analysis, a load in the **Corotating** frame is phase shifted to give the effect of rotation.
 - For a stationary analysis, **Frame type** has no influence on the analysis.
-

FORCE

Select a **Load type** — **Load defined as force per unit volume**, **force per unit length**, or **Total force**. Then enter values or expressions for the load components based on the selection.

- For **Load defined as force per unit volume**, you can define a distributed force over the volume. In this case the load is scaled by cross section area of the rotor to provide the force per unit length over the selected edges.
- For **Load defined as force per unit length**, you can define a distributed force over the selected edge.
- For **Total force**, the total force is divided by the length of the edges where the load is active in order to obtain the distributed load.



After selecting a **Load type**, the **Load** list normally only contains **User defined**. When combined with another physics interface that can provide this type of load, it is also possible to choose a predefined load from this list.

LOAD TYPE	VARIABLE	SI UNIT
Load defined as force per unit volume	F_V	N/m^3
Load defined as force per unit length	F_L	N/m
Total force	F_{tot}	N



- You can add the [Phase](#) subnode to specify the phase of this load in a frequency domain analysis.

LOCATION IN USER INTERFACE

Context Menus

Beam Rotor>Edge Load

Ribbon

Physics tab with **Beam Rotor** selected:

Edges>Beam Rotor>Edge Load

Point Load

Use a **Point Load** node to apply piont load on the rotor.

FRAME TYPE

Select a **Frame type** — **Spatial**, or **Corotating** to specify the load in the appropriate frame.



- Since the beam rotor is modeled in the spatial frame, a stationary load in a **Corotating** frame works as a rotating load in the model. This load changes its direction with the angular velocity of the rotor. A stationary load in the **Spatial** frame is a true static load for beam rotor.
- For a frequency domain analysis, load in the **Corotating** frame is phase shifted to give the effect of rotation.
- For a stationary analysis, **Frame type** has no influence on the analysis.

FORCE

Enter values or expressions for the force, \mathbf{F}_p , and moment, \mathbf{M}_p .



The **Load** list normally only contains **User defined**. When combined with another physics interface that can provide this type of load, it is also possible to choose a predefined load from this list.



- You can add the [Phase](#) subnode to specify the phase of this load in a frequency domain analysis.

LOCATION IN USER INTERFACE

Context Menus



Beam Rotor>Point Load

Ribbon

Physics tab with **Beam Rotor** selected:

Points>Beam Rotor>Point Load

Hydrodynamic Bearing

This chapter describes the Hydrodynamic Bearing interface () and its functionality, which is found under the **Structural Mechanics>Rotordynamics** branch () when adding a physics interface.

In this chapter:

- [Hydrodynamic Bearing Theory](#)
- [The Hydrodynamic Bearing Interface](#)

Hydrodynamic Bearing Theory

The following sections introduce you to the theory that is specific to the Hydrodynamic Bearing interface features:

- [Reynolds Equation](#)
- [Bearing Dynamic Coefficients Calculation](#)
- [Initial Film Thickness in Journal Bearing](#)
- [Floating Ring Bearing](#)
- [Initial Film Thickness in Thrust Bearings](#)

Reynolds Equation

Thin-Film Flow in Bearings

Figure 6-1 shows a typical configuration for the flow of fluid in a bearing. The upper boundary is referred to as the journal, and the lower boundary is referred to as the bearing. Damping or lubrication forces act on both surfaces.

In many cases, the gap is sufficiently small for the flow in the thin film to be isothermal. Usually, the gap thickness, h , is much smaller than the lateral dimensions of the geometry, L . If this is the case, it is possible to neglect inertial effects in the fluid in comparison to viscous effects. Additionally, the curvature of the reference surface can be ignored when $h/L \ll 1$. Under these assumptions, the *Reynolds equation* applies. For gas flows under the same conditions, it is possible to derive a modified form of the Reynolds equation, which uses the ideal gas law to eliminate the density from the equation system. Such a *modified Reynolds equation* can even be adapted to model the flow of rarefied gases.

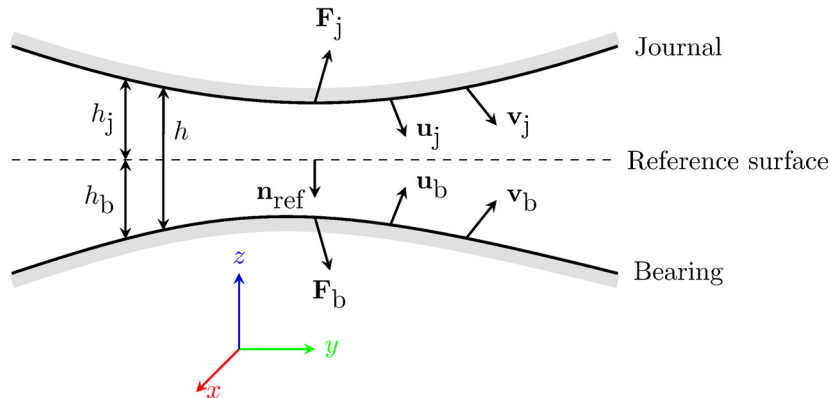

Figure 6-1: An example illustrating a typical configuration for thin-film flow. A reference surface with normal \mathbf{n}_{ref} sits in a narrow gap between a journal and bearing. In COMSOL Multiphysics

the vector \mathbf{n}_{ref} points into the bearing and out of the journal. The journal moves with a displacement \mathbf{u}_j and velocity \mathbf{v}_j from its initial position. Similarly, the bearing moves from its initial position with displacement \mathbf{u}_b and velocity \mathbf{v}_b . The compression of the

fluid results in an excess pressure, p_f , above the reference pressure, p_{ref} , and a fluid velocity in the gap. At a point on the reference surface, the average value of the fluid velocity along a line perpendicular to the surface is given by the in-plane vector \mathbf{v}_{ave} . The motion of the fluid results in forces on the journal (\mathbf{F}_j) and on the bearing (\mathbf{F}_b). The distance to the journal above the reference surface is h_j , while the bearing resides a distance h_b below the reference surface. The total size of the gap is $h=h_j+h_b$. At a given time, $h_j=h_{j1}-\mathbf{n}_{ref}\cdot\mathbf{u}_j$ and $h_b=h_{b1}-\mathbf{n}_{ref}\cdot\mathbf{u}_b$, where h_{j1} and h_{b1} are the initial distances to the journal and bearing, respectively.

The Reynolds Equation

The equations of fluid flow in thin films are usually formulated on a reference surface in the Eulerian frame. Consider a cylinder, fixed with respect to a stationary reference surface, as shown in Figure 6-2.

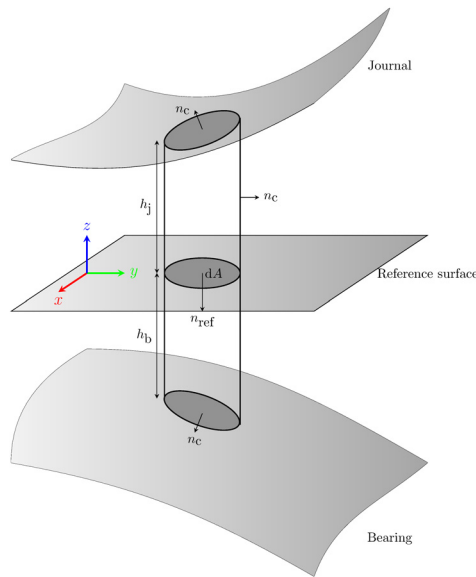

Figure 6-2: A reference cylinder, fixed with respect to the stationary reference surface, in a small gap between two surfaces (the journal and the bearing). The cylinder has an outward normal, \mathbf{n}_c . Its area, projected onto the reference surface, is dA .

The cylinder is fixed with respect to the reference surface, but its height can change due to changes in the position of the bearing and journal. Considering the flow in the

reference plane, the rate at which mass accumulates within the reference cylinder is determined by the divergence of the mass flow field in the reference plane:

$$\frac{d}{dt}(\rho h) = -\nabla_t \cdot (\rho h \mathbf{v}_{av}) \quad (6-1)$$

where $h = h_j + h_b$ and the tangential velocity, \mathbf{v}_{av} represents the mean velocity of the flow in the reference plane.

Particular care must be taken with respect to the definition of h . The above equation applies if h is measured with respect to a fixed point on the reference surface as a function of time. The reference surface itself must be fixed in space and obviously cannot deform as time progresses. Equations represented on the reference surface are described as Eulerian; that is, they are defined in a frame that is fixed with respect to the motion of the fluid or body. Fluid flow problems are usually formulated in the Eulerian frame and COMSOL Multiphysics adopts this convention in most of its fluid flow interfaces. The Eulerian frame is usually called the spatial frame within the COMSOL Multiphysics interface.

The journal and the bearing can, and often do, move with respect to the reference surface. The journal and bearing are usually the surfaces of bearing components that are deforming as a result of the pressure building up within the region of fluid flow. When describing the physics of a deforming solid, it is often convenient to work in the Lagrangian frame, which is fixed with respect to a small control volume of the solid. As the solid deforms, the Lagrangian frame moves along with the material contained within the control volume. Using the Lagrangian frame for describing structural deformation means that changes in the local density and material orientation as a result of the distortion of the control volume do not need to be accounted for by complicated transformations. In COMSOL Multiphysics, the Lagrangian frame, usually referred to as the material frame, is used for describing structural deformations. When a structure deforms in COMSOL Multiphysics, the material frame remains in the original configuration of the structure, and the deformation is accounted for by the underlying equations.

Because of the mixed Eulerian-Lagrangian approach adopted within COMSOL Multiphysics, particular care must be taken with the formulation of the Reynolds equations. Typically, it is not desirable to represent the geometry of the thin film directly, because it is often much smaller than the other components in the model. The equations apply on a single surface in the model, the reference surface. Since the reference surface should not deform, the equations are added on the material frame (even though this frame is normally used in a Lagrangian approach) and manual

transformations are added to the system to account for the fact that the structural equations also exist on the material frame, and employ a truly Lagrangian approach.

The situation encountered when both the journal and the bearing undergo a displacement is depicted in Figure 6-3. The Eulerian journal height changes from an initial value h_{j1} to a final value h_j . Similarly, the bearing height changes from an initial value h_{b1} to h_b .

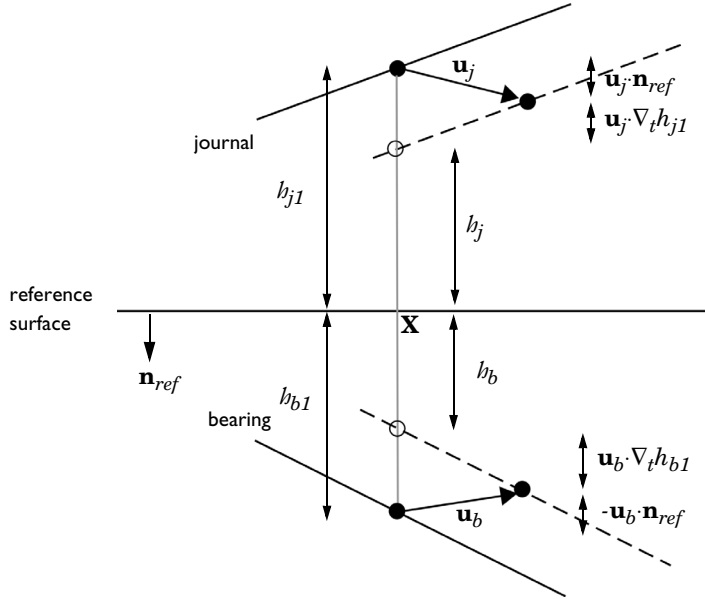

Figure 6-3: Diagram showing the displacement of the journal and the bearing with respect to the reference surface, and the corresponding change in the height of the channel.

From the figure, it is clear that:

$$\begin{aligned} h_j &= h_{j1} - \mathbf{u}_j \cdot \mathbf{n}_{ref} - \mathbf{u}_j \cdot \nabla_t h_{j1} \\ h_b &= h_{b1} + \mathbf{u}_b \cdot \mathbf{n}_{ref} - \mathbf{u}_b \cdot \nabla_t h_{b1} \\ h &= h_j + h_b \end{aligned} \quad (6-2)$$

Similar corrections should be applied to the velocity of the journal if it is computed from the structural displacement. That is, the velocity should be modified by a term proportional to its spatial gradient. However, this correction term is a second-order term, and consequently it is usually negligible in practical circumstances. It is neglected in the Hydrodynamic Bearing interface.

Consequently, provided that the definitions of the journal and bearing height from Equation 6-2 are used, the Reynolds equation takes the form:

$$\frac{\partial}{\partial t}(\rho h) + \nabla_t \cdot (h \rho \mathbf{v}_{av}) = 0 \quad (6-3)$$

Flow Models

The Navier-Stokes equations can be nondimensionalized for a domain whose width (h_0) is much smaller than its lateral dimension(s) (l_0) (see Ref. 1 for a detailed discussion). When $\text{Re}(h_0/l_0)^2 \ll 1$, and terms of order $(h_0/l_0)^2$ are neglected, the Navier-Stokes equations reduce to a modified form of the Stokes equation, which must be considered in conjunction with the continuity relation.

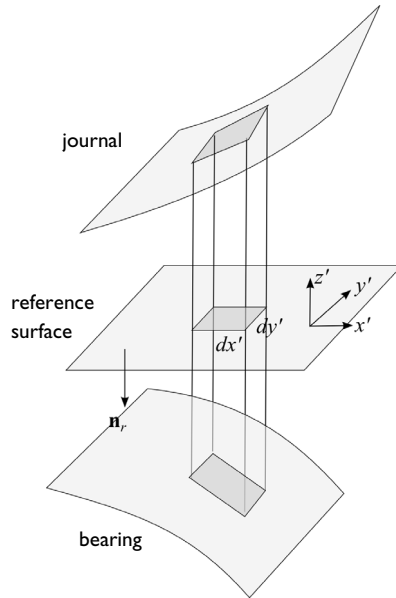

Figure 6-4: The coordinate system employed for the derivation of the average flow velocity.

The equations are most conveniently expressed by considering a local coordinate system in which x' and y' are tangent to the plane of the reference surface, and z' is perpendicular to the surface, as illustrated in Figure 6-4. Using this coordinate system:

$$\begin{aligned}\frac{\partial p_f}{\partial x'} &= \frac{\partial}{\partial z'} \left(\mu \frac{\partial v_{x'}}{\partial z'} \right) \\ \frac{\partial p_f}{\partial y'} &= \frac{\partial}{\partial z'} \left(\mu \frac{\partial v_{y'}}{\partial z'} \right) \\ \frac{\partial p}{\partial z'} &= 0\end{aligned}$$

Here p_f is the pressure resulting from the fluid flow, μ is the fluid viscosity, and $(v_{x'}, v_{y'})$ is the fluid velocity in the reference plane (which varies in the z' direction).

These equations can be integrated directly, yielding the in-plane velocity distributions, by making the assumption that the viscosity represents the mean viscosity through the film thickness. The following equations are derived:

$$\frac{\partial v_{x'}}{\partial z'} = \frac{z'}{\mu} \frac{\partial p_f}{\partial x'} + \frac{C_{1x'}}{\mu} \quad \frac{\partial v_{y'}}{\partial z'} = \frac{z'}{\mu} \frac{\partial p_f}{\partial y'} + \frac{C_{1y'}}{\mu} \quad (6-4)$$

$$v_{x'} = \frac{z^2}{2\mu} \frac{\partial p_f}{\partial x'} + \frac{C_{1x'} z'}{\mu} + C_{2x'} \quad v_{y'} = \frac{z^2}{2\mu} \frac{\partial p_f}{\partial y'} + \frac{C_{1y'} z'}{\mu} + C_{2y'} \quad (6-5)$$

The constants $C_{1x'}$, $C_{2x'}$, $C_{1y'}$, and $C_{2y'}$ are determined by the boundary conditions. Equation 6-4 shows that the flow is a linear combination of laminar Poiseuille and Couette flows. The velocity profile is quadratic in form, as shown in Equation 6-5.

The average flow rate in the reference plane, \mathbf{v}_{av} , is given by:

$$\mathbf{v}_{av} = \begin{bmatrix} \frac{1}{h} \int_{-h_b}^{h_{wj}} v_{x'} dz' \\ \frac{1}{h} \int_{-h_b}^{h_{wj}} v_{y'} dz' \end{bmatrix} = \frac{1}{h} \begin{bmatrix} \frac{(h_j^2 - h_j h_b + h_b^2)}{6\mu} \frac{\partial p_f}{\partial x'} + \frac{h_j - h_b}{2\mu} C_{1x'} + C_{2x'} \\ \frac{(h_j^2 - h_j h_b + h_b^2)}{6\mu} \frac{\partial p_f}{\partial y'} + \frac{h_j - h_b}{2\mu} C_{1y'} + C_{2y'} \end{bmatrix}$$

The forces acting on the journal are determined by the normal component of the viscous stress tensor, $\boldsymbol{\tau}$, at the journal and bearing walls ($\boldsymbol{\tau}\mathbf{n}$ - where \mathbf{n} is the normal that points out of the fluid domain). The viscous stress tensor takes the form:

$$\boldsymbol{\tau} = \mu(\nabla\mathbf{v} + (\nabla\mathbf{v}^T)) - p\mathbf{I} = \begin{bmatrix} -p_f + 2\mu\frac{\partial v_{x'}}{\partial x'} & \mu\left(\frac{\partial v_{y'}}{\partial x'} + \frac{\partial v_{x'}}{\partial y'}\right) & \mu\left(\frac{\partial v_{z'}}{\partial x'} + \frac{\partial v_{x'}}{\partial z'}\right) \\ \mu\left(\frac{\partial v_{x'}}{\partial y'} + \frac{\partial v_{y'}}{\partial x'}\right) & -p_f + 2\mu\frac{\partial v_{y'}}{\partial y'} & \mu\left(\frac{\partial v_{z'}}{\partial y'} + \frac{\partial v_{y'}}{\partial z'}\right) \\ \mu\left(\frac{\partial v_{x'}}{\partial z'} + \frac{\partial v_{z'}}{\partial x'}\right) & \mu\left(\frac{\partial v_{y'}}{\partial z'} + \frac{\partial v_{z'}}{\partial y'}\right) & -p_f + 2\mu\frac{\partial v_{z'}}{\partial z'} \end{bmatrix}$$

Neglecting the gradient terms, which are of order h_0/l_0 , results in the following form for the stress tensor:

$$\boldsymbol{\tau} \approx \begin{bmatrix} -p_f & 0 & \mu\frac{\partial v_{x'}}{\partial z'} \\ 0 & -p_f & \mu\frac{\partial v_{y'}}{\partial z'} \\ \mu\frac{\partial v_{x'}}{\partial z'} & \mu\frac{\partial v_{y'}}{\partial z'} & -p_f \end{bmatrix} \quad (6-6)$$

The components of the stress tensor can be expressed in terms of the velocity and pressure gradients using Equation 6-4. Note that the normals to both the journal and the bearing are parallel to the z' direction, to zeroth order in h_0/l_0 . The forces acting on the bearing and the journal are therefore given by:

$$\mathbf{f}_j = \begin{bmatrix} \frac{h_j \partial p_f}{\mu \partial x'} + \frac{C_{1x'}}{\mu} \\ \frac{h_j \partial p_f}{\mu \partial y'} + \frac{C_{1y'}}{\mu} \\ p_f \end{bmatrix} \quad \mathbf{f}_b = \begin{bmatrix} \frac{h_b \partial p_f}{\mu \partial x'} + \frac{C_{1x'}}{\mu} \\ \frac{h_b \partial p_f}{\mu \partial y'} + \frac{C_{1y'}}{\mu} \\ -p_f \end{bmatrix}$$

GENERAL SLIP BOUNDARY CONDITION

Assuming a slip length of L_{sj} at the journal, and a slip length of L_{sb} at the bearing, the general slip boundary conditions are given by:

$$\begin{aligned}
v_{x'}(z' = -h_b) - v_{x'}^b &= \frac{L_{sb}}{\mu} \tau_{z'x'}(z' = -h_b) = L_{sb} \frac{\partial v_{x'}}{\partial z'}(z' = -h_b) \\
v_{y'}(z' = -h_b) - v_{y'}^b &= \frac{L_{sb}}{\mu} \tau_{z'y'}(z' = -h_b) = L_{sb} \frac{\partial v_{y'}}{\partial z'}(z' = -h_b) \\
v_{x'}(z' = h_j) - v_{x'}^j &= -\frac{L_{sj}}{\mu} \tau_{z'x'}(z' = h_j) = -L_{sj} \frac{\partial v_{x'}}{\partial z'}(z' = h_j) \\
v_{y'}(z' = h_j) - v_{y'}^w &= -\frac{L_{sj}}{\mu} \tau_{z'y'}(z' = h_j) = -L_{sj} \frac{\partial v_{y'}}{\partial z'}(z' = h_j)
\end{aligned}$$

For non-identical slip lengths the constants $C_{1x'}$, $C_{2x'}$, $C_{1y'}$, and $C_{2y'}$ take the following values:

$$\begin{aligned}
C_{1x'} &= \frac{\mu(v_{x'}^j - v_{x'}^b)}{h + L_{sj} + L_{sb}} - \frac{h_b^2 - h_j^2 - 2L_{sj}h_j + 2L_{sb}h_b}{2(h + L_{sb} + L_{sj})} \frac{\partial p_f}{\partial x'} \\
C_{2x'} &= \frac{v_{x'}^j(h_b + L_{sb}) + v_{x'}^b(h_j + L_{sj})}{h + L_{sj} + L_{sb}} \\
&\quad - \frac{h_j^2(h_b + L_{sb}) + h_b^2(h_j + L_{sj}) + 2h_jh_b(L_{sj} + L_{sb}) + 2hL_{sj}L_{sb}}{2(h + L_{sj} + L_{sb})\mu} \frac{\partial p_f}{\partial x'} \\
C_{1y'} &= \frac{\mu(v_{y'}^j - v_{y'}^b)}{h + L_{sj} + L_{sb}} - \frac{h_b^2 - h_j^2 - 2L_{sj}h_j + 2L_{sb}h_b}{2(h + L_{sj} + L_{sb})} \frac{\partial p_f}{\partial y'} \\
C_{2y'} &= \frac{v_{y'}^j(h_b + L_{sb}) + v_{y'}^b(h_j + L_{sj})}{h + L_{sj} + L_{sb}} \\
&\quad - \frac{h_j^2(h_b + L_{sb}) + h_b^2(h_j + L_{sj}) + 2h_jh_b(L_{sj} + L_{sb}) + 2hL_{sj}L_{sb}}{2(h + L_{sj} + L_{sb})\mu} \frac{\partial p_f}{\partial y'}
\end{aligned}$$

The average flow rate becomes:

$$\mathbf{v}_{av} = \begin{bmatrix} \frac{h(v_{x'}^j + v_{x'}^b) + 2(L_{sj}v_{x'}^j + L_{sb}v_{x'}^b)}{2(h + L_{sj} + L_{sb})} - \frac{h(h^2 + 4h(L_{sj} + L_{sb}) + 12L_{sb}L_{sj})}{12\mu(h + L_{sj} + L_{sb})} \frac{\partial p_f}{\partial x'} \\ \frac{h(v_{y'}^j + v_{y'}^b) + 2(L_{sj}v_{y'}^j + L_{sb}v_{y'}^b)}{2(h + L_{sj} + L_{sb})} - \frac{h(h^2 + 4h(L_{sj} + L_{sb}) + 12L_{sb}L_{sj})}{12\mu(h + L_{sj} + L_{sb})} \frac{\partial p_f}{\partial y'} \end{bmatrix}$$

which can be expressed in vector notation as:

$$\mathbf{v}_{av} = \frac{1}{2(h + L_{sj} + L_{sb})} (\mathbf{I} - \mathbf{n}_r \mathbf{n}_r^T) ((h + 2L_{sj}) \mathbf{v}_j + (h + 2L_{sb}) \mathbf{v}_b) - \frac{h(h^2 + 4h(L_{sj} + L_{sb}) + 12L_{sb}L_{sj})}{12\mu(h + L_{sj} + L_{sb})} \nabla_t p_f$$

The above equation can be written on the form:

$$\mathbf{v}_{av} = \mathbf{v}_{av,c} - v_{av,p} \nabla_t p_f \quad (6-7)$$

where $\mathbf{v}_{av,c}$ is a term associated with Couette flow, and $v_{av,p}$ is a coefficient associated with Poiseuille flow (see Table 6-1 below).

The forces acting on the two boundaries are given by:

$$\mathbf{f}_j = \begin{bmatrix} -\frac{h(h + 2L_{sb})}{2(h + L_{sj} + L_{sb})} \frac{\partial p_f}{\partial x'} + \frac{(v_{x'}^b - v_{x'}^j)\mu}{(h + L_{sj} + L_{sb})} \\ -\frac{h(h + 2L_{sb})}{2(h + L_{sj} + L_{sb})} \frac{\partial p_f}{\partial y'} + \frac{(v_{y'}^b - v_{y'}^j)\mu}{(h + L_{sj} + L_{sb})} \\ p_f \end{bmatrix} \quad (6-8)$$

$$\mathbf{f}_b = \begin{bmatrix} -\frac{h(h + 2L_{sj})}{2(h + L_{sj} + L_{sb})} \frac{\partial p_f}{\partial x'} + \frac{(v_{x'}^j - v_{x'}^b)\mu}{(h + L_{sj} + L_{sb})} \\ -\frac{h(h + 2L_{sj})}{2(h + L_{sj} + L_{sb})} \frac{\partial p_f}{\partial y'} + \frac{(v_{y'}^j - v_{y'}^b)\mu}{(h + L_{sj} + L_{sb})} \\ -p_f \end{bmatrix}$$

Note that the z' direction corresponds to the $-\mathbf{n}_r$ direction. The x' and y' directions correspond to the two tangent vectors in the plane. Using vector notation the forces become:

$$\mathbf{f}_j = -\frac{h(h + 2L_{sb})}{2(h + L_{sj} + L_{sb})} \nabla_t p_f + \frac{\mu}{h + L_{sj} + L_{sb}} (\mathbf{I} - \mathbf{n}_r \mathbf{n}_r^T) (\mathbf{v}^b - \mathbf{v}^j) + p_f \mathbf{n}_j$$

$$\mathbf{f}_b = -\frac{h(h + 2L_{sj})}{2(h + L_{sj} + L_{sb})} \nabla_t p_f + \frac{\mu}{h + L_{sj} + L_{sb}} (\mathbf{I} - \mathbf{n}_r \mathbf{n}_r^T) (\mathbf{v}^j - \mathbf{v}^b) + p_f \mathbf{n}_b$$

In Equation 6-8 it is assumed that $\mathbf{n}_j = -\mathbf{n}_r$ and $\mathbf{n}_b = \mathbf{n}_r$. In COMSOL Multiphysics the accuracy of the force terms is improved slightly over the usual approximation (which neglects the slope of the journal and bearing as it is of order h_0/l_0) by using the following equations for \mathbf{n}_j and \mathbf{n}_b :

$$\mathbf{n}_j = (-\mathbf{n}_r - \nabla_t h_j)$$

$$\mathbf{n}_b = (\mathbf{n}_r - \nabla_t h_b)$$

These definitions are derived from Equation 6-4 and Equation 6-5 and include the additional area that the pressure acts on as a result of the slopes of journal and bearing surfaces.

Once again, the force terms can be written on the form:

$$\begin{aligned} \mathbf{f}_j &= -f_{j,p} \nabla_t p_f + \mathbf{f}_{j,c} \\ \mathbf{f}_b &= -f_{b,p} \nabla_t p_f + \mathbf{f}_{b,c} \end{aligned} \quad (6-9)$$

where $f_{j,p}$ is the Poiseuille coefficient for the force on the journal, and $\mathbf{f}_{j,c}$ incorporates the Couette and normal forces (due to the pressure) on the journal. Similarly, $f_{b,p}$ is the Poiseuille coefficient for the force on the bearing, and $\mathbf{f}_{b,c}$ incorporates the Couette and normal forces (due to the pressure) on the bearing.

The cases of identical slip length and non-slip are limiting cases of the formulas derived above. The main results are summarized in Table 6-1, where the constants defined in Equation 6-7 and Equation 6-9 are used.

TABLE 6-1: EQUATION VARIABLES FOR VARIOUS FLOW MODELS

VARIABLE	DEFINITION
General Slip Flow Model	
$\mathbf{v}_{av,c}$	$\frac{1}{2(h + L_{sj} + L_{sb})}(\mathbf{I} - \mathbf{n}_r \mathbf{n}_r^T)((h + 2L_{sb})\mathbf{v}_j + (h + 2L_{sj})\mathbf{v}_b)$
$v_{av,p}$	$\frac{h(h^2 + 4h(L_{sj} + L_{sb}) + 12L_{sb}L_{sj})}{12\mu(h + L_{sj} + L_{sb})}$
$\mathbf{f}_{j,c}$	$\frac{\mu}{h + L_{sj} + L_{sb}}(\mathbf{I} - \mathbf{n}_r \mathbf{n}_r^T)(\mathbf{v}^b - \mathbf{v}^j) + p_f \mathbf{n}_j$
$f_{j,p}$	$\frac{h(h + 2L_{sb})}{2(h + L_{sj} + L_{sb})}$
$\mathbf{f}_{b,c}$	$\frac{\mu}{h + L_{sj} + L_{sb}}(\mathbf{I} - \mathbf{n}_r \mathbf{n}_r^T)(\mathbf{v}^j - \mathbf{v}^b) + p_f \mathbf{n}_b$
$f_{b,p}$	$\frac{h(h + 2L_{sj})}{2(h + L_{sj} + L_{sb})}$
Equal Slip Lengths Flow Model $L_{sj}=L_{sb}=L$	
$\mathbf{v}_{av,c}$	$\frac{1}{2}(\mathbf{I} - \mathbf{n}_r \mathbf{n}_r^T)(\mathbf{v}_j + \mathbf{v}_b)$
$v_{av,p}$	$(h^2 + 6L_s h)/(12\mu)$
$\mathbf{f}_{j,c}$	$\frac{\mu}{h + 2L_s}(\mathbf{I} - \mathbf{n}_r \mathbf{n}_r^T)(\mathbf{v}^b - \mathbf{v}^j) + p_f \mathbf{n}_j$
$f_{j,p}$	$h/2$
$\mathbf{f}_{b,c}$	$\frac{\mu}{h + 2L_s}(\mathbf{I} - \mathbf{n}_r \mathbf{n}_r^T)(\mathbf{v}^j - \mathbf{v}^b) + p_f \mathbf{n}_b$
$f_{b,p}$	$h/2$

TABLE 6-1: EQUATION VARIABLES FOR VARIOUS FLOW MODELS

VARIABLE	DEFINITION
Non-Slip Flow Model $L_s=L_{sb}=0$	
$\mathbf{v}_{av,c}$	$\frac{1}{2}(\mathbf{I} - \mathbf{n}_r \mathbf{n}_r^T)(\mathbf{v}_j + \mathbf{v}_b)$
$u_{av,p}$	$h^2/(12\mu)$
$\mathbf{f}_{j,c}$	$\frac{\mu}{h}(\mathbf{I} - \mathbf{n}_r \mathbf{n}_r^T)(\mathbf{v}^b - \mathbf{v}^j) + p_f \mathbf{n}_j$
$f_{j,p}$	$h/2$
$\mathbf{f}_{b,c}$	$\frac{\mu}{h}(\mathbf{I} - \mathbf{n}_r \mathbf{n}_r^T)(\mathbf{v}^j - \mathbf{v}^b) + p_f \mathbf{n}_b$
$f_{b,p}$	$h/2$

The Modified Reynolds Equation — Gas Flows

Thin-film gas flows are often isothermal, and in many cases the ideal gas law can be assumed. Under these circumstances, the ideal gas law can be written on the form:

$$p_A = \frac{RT_0}{M_n} \rho$$

where T_0 is the (constant) temperature of the gas, M_n is the molar mass of the gas, and R is the universal gas constant. Here, the total gas pressure is $p_A = p_{ref} + p_f$, where p_A is the absolute pressure and p_f is the pressure developed as a result of the flow. Substituting this relation into Equation 6-3 and dividing by the constant M_n/RT_0 results in a modified form of the Reynolds equation:

$$\frac{\partial}{\partial t}(p_A h) + \nabla_t \cdot (h p_A \mathbf{v}_{av}) - p_A (\mathbf{v}_j \cdot \nabla_t h_j + \mathbf{v}_b \cdot \nabla_t h_b) = 0 \quad (6-10)$$

This equation can be used to model isothermal flows of ideal gases. The average flow rate and the forces acting on the bearings are computed in the same manner as for the standard Reynolds equation.

SLIP BOUNDARY CONDITIONS FOR GASES

For a gas, the slip length is often expressed using the mean free path, λ , and a tangential momentum accommodation coefficient, α . For compatibility with the existing

literature on thin-film gas flow, the following definition of the mean free path is used by COMSOL Multiphysics in the Hydrodynamic Bearing interface:

$$\lambda = \frac{\mu}{p} \left(\frac{2RT}{M_n} \right)^{\frac{1}{2}}$$

The slip length is then defined as:

$$L_s = \frac{\sqrt{\pi}}{2} \lambda \left(\frac{2-\alpha}{\alpha} \right)$$

Values for the tangential momentum accommodation coefficients for various gas surface combinations are given in [Ref. 2](#).

Boundary Conditions

Most of the boundary conditions either constrain the flow into the system by prescribing a fluid velocity or constrain the pressure at the boundary. The border flow condition is slightly more complex, requiring the gradient of the pressure to be set by specifying the value of the gradient of the pressure in the antinormal direction such that:

$$-\mathbf{n} \cdot \nabla p = \Gamma$$

The **Border flow type** selection list enables four ways that the value of Γ can be specified:

- The **User defined** option allows the value of Γ to be directly entered as an expression in a user input box. This allows for arbitrary normal pressure gradients.
- The two **Acoustic elongation** options assume a linear gradient in the pressure outside the domain away from the boundary. The pressure gradient is calculated by dividing the pressure at the boundary, p_f , by an elongation length, ΔL . The elongation length can either be specified as an absolute length or as a fraction of the domain width, such that:

$$-\mathbf{n} \cdot \nabla p = \frac{p_f}{\Delta L}$$

- The **Out-of-plane motion** option calculates the pressure gradient at the boundary using a model detailed in [Ref. 8](#). This model is suitable for including the effects of gas damping when fluid in a thin gap is subjected to out-of-plane motion of the journal or bearing, for example when a microbeam is oscillating above an extended

surface. When this option is selected, input fields are provided to specify the required coefficients (ζ, η, χ) and the pressure gradient is defined according to

$$-\mathbf{n} \cdot \nabla p = \zeta \frac{12\mu U}{\eta h^2} \left(1 + \chi \frac{6\Lambda}{h}\right)^{-1} + \frac{p - p_\infty}{\eta h^2}$$

where U is the out-of-plane velocity, Λ is the slip length at the walls, and p_∞ is the ambient pressure far from the boundary and away from the domain.

Cavitation

Several types of cavitation can occur in thin-film flow. When the flow pressure drops below the ambient pressure, the air and other gases dissolved within the fluid are released. This phenomenon, characteristic of loaded bearings, is known as cavitation or gaseous cavitation. In some cases involving high-frequency varying loads, as in internal combustion engines, the pressure might drop below the fluid vapor pressure, which is lower than the ambient pressure. In this case, bubbles are formed by rapid evaporation or boiling of the fluid. This phenomenon is known as vapor cavitation. The cavitation feature in COMSOL Multiphysics is designed to address gaseous cavitation.

The implementation of the cavitation feature is based on a modified version of the Elrod algorithm (Ref. 9 and Ref. 10). This algorithm automatically predicts film rupture and reformation in bearings and offers a reasonable compromise between accuracy and practicality. It is applicable to heavily and moderately loaded bearings but it is not suitable when surface tension plays an important role.

Elrod and Adams' algorithm is based on the JFO cavitation theory, a widely accepted and adopted theory developed by Jakobson (Ref. 11), Floberg (Ref. 12 and Ref. 13), and Olsson (Ref. 14). The JFO theory divides the flow in two regions:

- A full-film region where the pressure varies but is limited from below by the cavitation pressure.
- A cavitation region where only part of the volume is occupied by the fluid. Because of the presence of the gas in the void fraction, the pressure in this region is assumed to be constant and equal to the cavitation pressure.

Elrod and Adams derived a general form of the Reynolds equation, Equation 6-1, by introducing a switch function, g , equal to 1 in the full-film region and 0 in the cavitation region. This switch function allows for solving a single equation for both the

full-film and cavitation regions and leads to a modified equation for the average velocity.

$$\mathbf{v}_{av} = \mathbf{v}_{av,c} - g v_{av,p} \nabla_t p_f$$

where the second and third terms on the left-hand side correspond to the average Couette and average Poiseuille velocities, respectively. This switch function sets the average Poiseuille velocity to zero in the cavitation region.



Because the average Poiseuille velocity is set to zero in the cavitation region, the density needs to be a function of the pressure variable and is defined as

$$\rho = \rho_c e^{\beta p_f}$$

where β is the compressibility and ρ_c is the density at the cavitation pressure. A density that is not pressure dependent would lead to empty equations in the cavitation region, since the pressure variable p_f would no longer be present in the governing equations.

A variable θ can be defined, given by:

$$\theta = \frac{\rho}{\rho_c}$$

In the cavitation region ($\theta < 1$), θ represents the fractional film content.

RESULT PRESENTATION

While the pressure is constant and equal to the cavitation pressure in the cavitation region, the computed pressure is negative in this region. The value of this negative pressure can physically be interpreted as the volume fraction of fluid in the cavitation region. The actual or physical pressure, available in the postprocessing section as `tfss.p`, is equal to the computed pressure in the full-film region ($\theta \geq 1$) and equal to the cavitation pressure in the cavitation region ($\theta < 1$).

Dissipation

Due to the viscous friction, heat will be produced in the lubricating film. In some cases, it may be important to couple the flow in the bearing to a heat transfer analysis. In the Hydrodynamic Bearing interface, the dissipated energy per volume is computed. It is

available in a variable named $hdb.Qvd$, which you can use as a heat source in a thermal analysis.

Viscous dissipation per unit volume in a flow can be calculated in terms of the rate of deformation and stress tensors:

$$Q_{vd} = \tau:S$$

with

$$S = \frac{1}{2}(\nabla\mathbf{v} + \nabla\mathbf{v}^T)$$

and

$$\tau = 2\mu S - \frac{2}{3}\mu(\nabla \cdot \mathbf{v})I$$

For a thin film flow approximation (neglecting higher orders of h/l) the rate of deformation and stress tensor in the local system are approximated as

$$S \approx \begin{bmatrix} 0 & 0 & \frac{1}{2}\frac{\partial v_{x'}}{\partial z'} \\ 0 & 0 & \frac{1}{2}\frac{\partial v_{y'}}{\partial z'} \\ \frac{1}{2}\frac{\partial v_{x'}}{\partial z'} & \frac{1}{2}\frac{\partial v_{y'}}{\partial z'} & 0 \end{bmatrix}$$

and

$$\tau \approx \begin{bmatrix} -p_f & 0 & \mu\frac{\partial v_{x'}}{\partial z'} \\ 0 & -p_f & \mu\frac{\partial v_{y'}}{\partial z'} \\ \mu\frac{\partial v_{x'}}{\partial z'} & \mu\frac{\partial v_{y'}}{\partial z'} & -p_f \end{bmatrix}$$

Therefore, in a thin film flow the viscous dissipation is approximately given by

$$Q_{vd} = \mu \left[\left(\frac{\partial v_x}{\partial z'} \right)^2 + \left(\frac{\partial v_y}{\partial z'} \right)^2 \right]$$

Substituting the velocity expression in terms of the pressure in the film and integrating across the film thickness the heat dissipation per unit area of the film is given by

$$Q_{vd,A} = \frac{h^3}{12\mu} (\nabla_t p_f \cdot \nabla_t p_f) + \frac{h}{\mu(h + L_{sj} + L_{sb})} \{h_L^2 \nabla_t p_f - \mu(\mathbf{v}^j - \mathbf{v}^b)_t\} \cdot \{h_L^2 \nabla_t p_f - \mu(\mathbf{v}^j - \mathbf{v}^b)_t\}$$

where

$$h_L^2 = h_b^2 - h_j^2 - \left(\frac{3L_{sj} + L_{sb}}{2} \right) h_j + \left(\frac{3L_{sb} + L_{sj}}{2} \right) h_b$$

Here, h_b is the height of the bearing from the reference surface and h_j is the height of the journal from the reference surface. L_{sj} and L_{sb} are the slip lengths at the journal and bearing surfaces, respectively. $(\mathbf{v}^j - \mathbf{v}^b)_t$ is the tangential velocity component of the relative journal velocity with respect to the bearing in the film plane.

Therefore, viscous dissipation per unit volume will be approximately given by

$$Q_{vd} = \frac{h^2}{12\mu} (\nabla_t p_f \cdot \nabla_t p_f) + \frac{1}{\mu(h + L_{sj} + L_{sb})} \{h_L^2 \nabla_t p_f - \mu(\mathbf{v}^j - \mathbf{v}^b)_t\} \cdot \{h_L^2 \nabla_t p_f - \mu(\mathbf{v}^j - \mathbf{v}^b)_t\}$$

Misalignment

Misalignment in bearings can occur due to improper mounting. Misalignment often results in metal to metal contact in the bearing components with high contact forces. This gives rise to noise and high temperatures in the bearing. The misalignment is broadly classified in the following categories:

- Parallel misalignment: The axes of the bearings are parallel to each other but the bearing centers are offset in the lateral direction (see [Figure 6-5](#)).

- Angular misalignment: The axes of the bearings are not perfectly parallel. Rather, they are slightly inclined relative to each other (see Figure 6-6). Bearing centers are still aligned in the direction of the rotor axis.
- A combination of the above two.

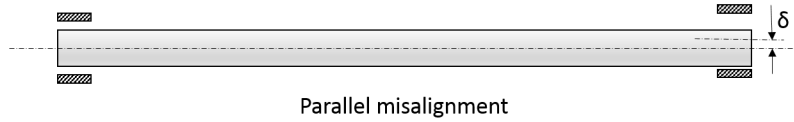

Figure 6-5: Parallel misalignment

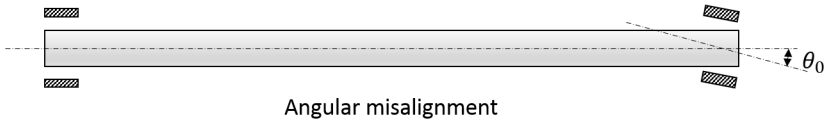

Figure 6-6: Angular misalignment

The film thickness in a hydrodynamic bearing changes as an effect of its misalignment with the rotor axis. As a result, the pressure distribution in the bearing also gets affected. Let \mathbf{u}_0 and θ_0 be the parallel and angular misalignments, respectively. Then the net change in the film thickness due to misalignment can be calculated by

$$\Delta h = [\mathbf{u}_0 + \theta_0 \times (\mathbf{X} - \mathbf{X}_c)] \cdot \mathbf{n}_{\text{ref}}$$

\mathbf{X} is the coordinate on the journal/collar surface, \mathbf{X}_c is the center of the bearing and \mathbf{n}_{ref} is the material normal of the journal/collar surface. Therefore, the height of the bearing from the reference surface will be given by

$$h_b = h_0 + \Delta h$$

where h_0 is the film thickness without the misalignment in the bearing.

References for the Thin-Film Flow Interfaces

1. B.J. Hamrock, S.R. Schmid, and B.O. Jacobson, *Fundamentals of Fluid Film Lubrication*, Marcel Dekker, 2004.

2. F. Sharipov, “Data on the Velocity Slip and Temperature Jump on a Gas-Solid Interface”, *J. Phys. Chem. Ref. Data*, vol. 40, no. 2, 023101, 2011.
3. S. Fukui and R. Kaneko, “Analysis of Ultra-Thin Gas Film Lubrication Based on Linearized Boltzmann Equation: First Report — Derivation of a Generalized Lubrication Equation Including Thermal Creep Flow”, *J. Tribology*, vol. 110, no. 2, pp. 253–261, 1988.
4. S. Fukui and R. Kaneko, “A Database for Interpolation of Poiseuille Flow Rates for High Knudsen Number Lubrication”, *Transactions of the ASME*, vol. 112, pp. 78–83, 1990.
5. T. Veijola, H. Kuisma, and J. Lahdenperä, “The Influence of Gas-surface Interaction on Gas Film Damping in a Silicon Accelerometer”, *Sensors and Actuators*, vol. A 66, pp. 83–92, 1998.
6. C. Cercignani, Maria Lampis, and Silvia Lorenzani “Variational Approach to Gas Flows in Microchannels”, *Physics of Fluids*, vol. 16, no. 9, 2004.
7. J.R. Torczynski and M.A. Gallis, “DSMC-Based Shear-Stress/Velocity-Slip Boundary Condition for Navier-Stokes Couette-Flow Simulations”, 27th International Symposium on Rarefied Gas Dynamics (2010), *AIP Conf. Proc.* vol. 1333, pp. 802–807, 2011.
8. M. A. Gallis and J. R. Torczynski, “An Improved Reynolds-Equation Model for Gas Damping of Microbeam Motion”, *Journal of Microelectromechanical Systems*, vol. 13, pp. 653–659, 2004.
9. H. G. Elrod, “A Cavitation Algorithm”, *J. Lubrication Technology*, vol. 103, no. 3, 350–354, 1981.
10. H. G. Elrod and M. L. Adams, “A computer program for cavitation and starvation problems”, *Cavitation and related phenomena in lubrication, Proceedings of the 1st Leeds–Lyon Symposium on Tribology*, University of Leeds, UK, 1974.
11. B. Jacobson and L. Floberg, “The finite journal bearing considering vaporization”, *Transactions of Chalmers University Technology*, Göteborg, Sweden, vol. 190, 1–119, 1957.
12. L. Floberg, “On journal bearing lubrication considering the tensile strength of the liquid lubricant”, *Transactions of the Machine Elements Division*, Lund Technical University, Lund, Sweden, pp. 1–26, 1973.

13. L. Floberg, “Cavitation boundary conditions with regard to the number of streamers and tensile strength of the liquid”, *Cavitation and related phenomena in lubrication, Proceedings of the 1st Leeds–Lyon Symposium on Tribology*, University of Leeds, UK, pp. 31–36 (Mechanical Engineering Publications Ltd, London, UK), 1974.
14. K.O. Olsson, “Cavitation in dynamically loaded bearings”, *Transactions of Chalmers University Technology*, Göteborg, Sweden, vol. 308, 1965.

Bearing Dynamic Coefficients Calculation

Bearing dynamic coefficients are the effective stiffness and damping coefficients of the bearing when the rotor is at its equilibrium position. For a sufficiently loaded bearing, the rotor will in steady state take an eccentric equilibrium position in the bearing to support the static loads. It then does a small amplitude whirl about this equilibrium position due to the dynamic loads on the rotor such as eccentricity, misalignment etc. A dynamic coefficient approximation works well if the static load on the rotor is much larger than the dynamic loads. If dynamic load is comparable to the static load or the bearing is lightly loaded, the rotor undergoes a large amplitude whirl without any well defined equilibrium position. In such a case, the nonlinearity of the bearing forces must be accounted in order to accurately predict the dynamics of the rotor.

Determination of the dynamic coefficients of the bearing is done at the equilibrium position of the journal for the given static load. The change in the net bearing reaction forces as the bearing equilibrium position is disturbed is then obtained. There are two fundamentally different approaches that can be used: infinitesimal perturbation and finite perturbation.

INFINITESIMAL PERTURBATION

Perturbed differential equations in terms of new pressure perturbation degrees of freedom are obtained by considering the derivative of the Reynolds equation with respect to the equilibrium position perturbation. Bearing dynamic coefficients are expressed in terms of the new pressure perturbation degrees of freedom.

This is the method used in the Rotordynamics Module.

FINITE PERTURBATION

Reynolds equation is solved for two conditions, first at the equilibrium state and then by considering a finite perturbation to the equilibrium position. The difference in the net reaction force in the bearing with respect to the perturbation gives the corresponding coefficients. In this approach, perturbation amplitudes should be small enough to get the accurate results. Typical perturbation values used are $0.01C$ for displacement and $0.01\Omega C$ for velocity.

Perturbation Equations

Consider the Reynolds equation describing the flow in the thin channels:

$$\frac{\partial}{\partial t}(\rho h) + \nabla_t \cdot (\rho h \mathbf{v}_{\text{ave}}) = 0$$

with

$$\begin{aligned} h &= h_{b1} + \mathbf{u}_b \cdot \mathbf{n}_{\text{ref}} - (\mathbf{u}_b \cdot \nabla_t h_{b1}) - \mathbf{u}_j \cdot \mathbf{n}_{\text{ref}} \\ \mathbf{v}_{\text{ave}} &= \left(\frac{1}{2}(\mathbf{v}_{j,t} + \mathbf{v}_{b,t}) - \frac{h^2}{12\mu} \nabla_t p \right) \\ \frac{\partial h}{\partial t} &= \mathbf{v}_b \cdot \mathbf{n}_{\text{ref}} - (\mathbf{v}_b \cdot \nabla_t h_{b1}) - \mathbf{v}_j \cdot \mathbf{n}_{\text{ref}} \end{aligned}$$

Let \mathbf{u}_{j0} and \mathbf{u}_{b0} be the equilibrium states with $\mathbf{v}_{j0} = \mathbf{v}_{b0} = \mathbf{0}$. Introduce infinitesimal perturbations in journal position $d\mathbf{u}_j$ and velocity $d\mathbf{v}_j$, respectively. The bearing position and velocity are not perturbed. Taking the derivative of Reynolds equation with respect to \mathbf{u}_j and \mathbf{v}_j gives the perturbation equation.

$$\frac{\partial}{\partial \mathbf{u}_j} \left[\frac{\partial}{\partial t}(\rho h) + \nabla_t \cdot (\rho h \mathbf{v}_{\text{ave}}) \right] = 0$$

Performing this derivative using the expressions for h and \mathbf{v}_{ave} gives

$$\nabla_t \cdot \left(\frac{\rho h^3}{12\mu} \nabla_t \mathbf{p}_u \right) = -\frac{\partial}{\partial t} \rho \mathbf{n}_{\text{ref}} + \nabla_t \cdot \left[\left(\frac{h^2}{4\mu} \nabla_t p - \frac{1}{2}(\mathbf{v}_{j,t} + \mathbf{v}_{b,t}) \right) \otimes \rho \mathbf{n}_{\text{ref}} \right]^T$$

where \mathbf{p}_u represents derivative of p with respect to \mathbf{u}_j . In equilibrium

$$\begin{aligned} \mathbf{v}_j &= \Omega \times (\mathbf{X} - \mathbf{X}_c) \\ \mathbf{v}_b &= \mathbf{0} \end{aligned}$$

Substituting this in the perturbation equation gives

$$\nabla_t \cdot \left(\frac{\rho h^3}{12\mu} \nabla_t \mathbf{p}_u \right) = -\frac{\partial}{\partial t} \rho \mathbf{n}_{\text{ref}} + \nabla_t \cdot \left[\left(\frac{h^2}{4\mu} \nabla_t p - \frac{\Omega}{2} \times (\mathbf{X} - \mathbf{X}_c) \right) \otimes \rho \mathbf{n}_{\text{ref}} \right]^T$$

Similarly, a derivative with respect to \mathbf{v}_j results in

$$\nabla_t \cdot \left(\frac{\rho h^3}{12\mu} \nabla_t \mathbf{p}_v \right) = -\rho \mathbf{n}_{\text{ref}} + \nabla_t \cdot \left[\frac{\rho h}{2} (\mathbf{I} - \mathbf{n}_{\text{ref}} \otimes \mathbf{n}_{\text{ref}}) \right]$$

where \mathbf{p}_v represents derivative of p with respect to \mathbf{v}_j . The pressure and film thickness profile in the right hand side of these equations are determined from the static equilibrium position given by the static load on the bearing.

$$\nabla_t \cdot \left(\frac{\rho h^3}{12\mu} \nabla_t p \right) = \frac{\partial}{\partial t} \rho h + \nabla_t \cdot \left[\frac{\rho h}{2} (\boldsymbol{\Omega} \times (\mathbf{X} - \mathbf{X}_c)) \right]$$

The pressure distribution must balance the external load so that

$$\int_A \mathbf{f}_j dA = \mathbf{W}$$

where \mathbf{f}_j is the force on the journal due to the lubricant pressure and shear and \mathbf{W} is the load vector acting on the bearing. This forms a system of equations for the pressure perturbations \mathbf{p}_u and \mathbf{p}_v .

Boundary Conditions

The boundary conditions for the perturbation degrees of freedom \mathbf{p}_u and \mathbf{p}_v are

$$\begin{aligned} \mathbf{p}_u &= \mathbf{0} \\ \mathbf{p}_v &= \mathbf{0} \end{aligned}$$

on the boundary.

Stiffness and Damping Coefficients

The component of the stiffness coefficients in the local bearing directions are given in term of the perturbed degrees of freedom as follows:

$$k_{ij} = \int_A (\mathbf{p}_u \cdot \mathbf{e}_j) (\mathbf{n}_{\text{ref}} \cdot \mathbf{e}_i) (p > 0) dA$$

where \mathbf{e}_i are the local bearing direction, and the integration is performed over the bearing surface. Similarly the components of the damping coefficients in the local bearing directions are given by:

$$c_{ij} = \int_A (\mathbf{p}_v \cdot \mathbf{e}_j) (\mathbf{n}_{\text{ref}} \cdot \mathbf{e}_i) (p > 0) dA$$

Initial Film Thickness in Journal Bearing

The initial film thickness is calculated by assuming that the reference surface is the initial journal surface itself. Therefore, the height of the bearing surface from the reference surface (journal) gives the initial film thickness. Initially, both the journal and bearing are concentric. The following sections describe the initial film thickness in different type of bearings.

Plain

A sketch of the plain journal bearing is given in [Figure 6-7](#) below:

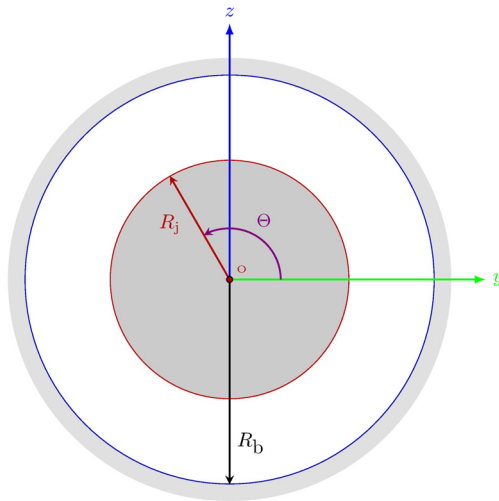

Figure 6-7: Plain journal bearing.

In this case, the initial film thickness does not depend on the polar coordinate, Θ , and is equal to the difference between the bearing and journal radius:

$$h_{b1} = C$$

Elliptic

In an elliptic journal bearing, the bearing surface has an elliptical shape. A sketch of the elliptic journal bearing is shown in [Figure 6-8](#):

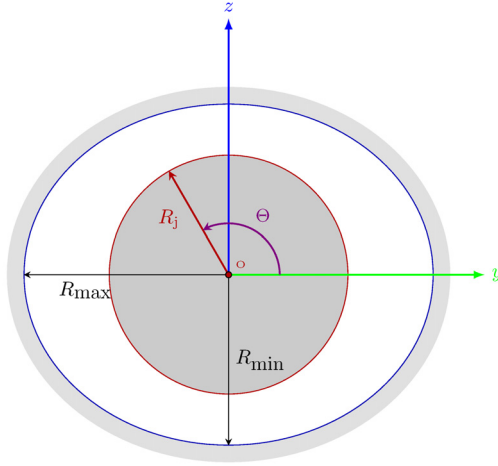

Figure 6-8: Elliptic journal bearing.

In this case, the initial film thickness depends on the polar coordinate Θ and is given by:

$$h_{b1} = C_{\min} + (C_{\max} - C_{\min})(\cos \Theta)^2$$

Here, C_{\min} and C_{\max} are the minimum and maximum clearance values in the bearing, occurring along the minor and major axis of the ellipse. The variable Θ is the polar angle of a point on the journal surface measured from the local y direction to local z direction and is given by

$$\Theta = \operatorname{atan}\left(\frac{\mathbf{n} \cdot \mathbf{e}_3}{\mathbf{n} \cdot \mathbf{e}_2}\right)$$

Split Halves

In a split halves journal bearing, the bearing surface consists of two separate circular halves that are offset by a distance $2d$ in the local y direction. A sketch of such a bearing is shown in Figure 6-9:

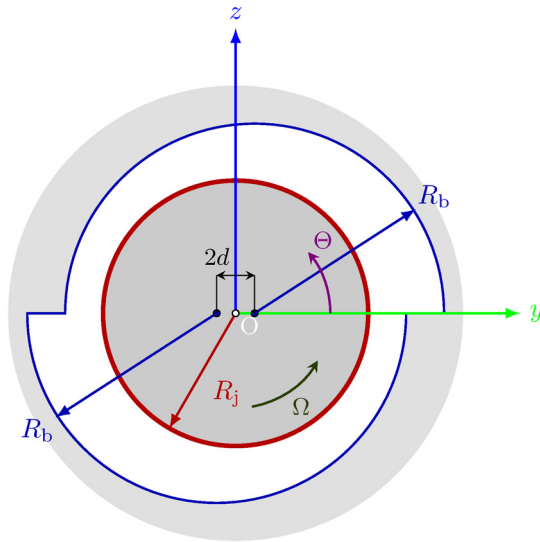

Figure 6-9: Split halves journal bearing.

The initial film thickness for the split halves bearing is given by:

$$h_{b1} = \begin{cases} C + d \cos \Theta; & 0 \leq \Theta < \pi \\ C - d \cos \Theta; & \pi \leq \Theta < 2\pi \end{cases}$$

C is the difference between the radius of the bushing and the journal, and d is the distance by which the center of the upper and lower halves are offset from the journal center.

Multilobe

In a multilobe journal bearing, the bearing surface consists of many small pads. Therefore, in this case the film thickness is discontinuous in the polar coordinate Θ . A sketch for the multilobe bearing is shown in Figure 6-10:

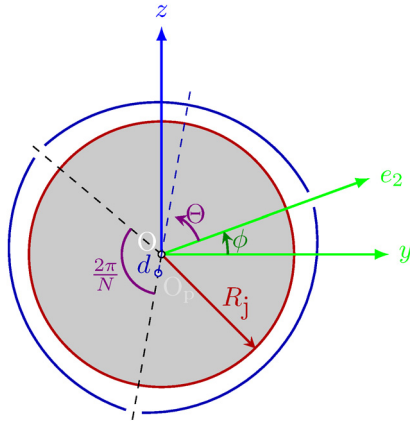

Figure 6-10: Multilobe journal bearing.

The initial film thickness for the multilobe bearing is given by

$$h_{b1} = C + d \cos(\Theta - \alpha_m)$$

where α_m is the mid-pad angle. For an N -pad bearing, it is given by

$$\alpha_m = \frac{\pi}{N} \left[1 + 2 \operatorname{int} \left(\frac{N\Theta}{2\pi} \right) \right]$$

and d is the distance between the center of the pad and center of the journal in the initial configuration. The line joining the center of the pad and center of the journal bisect the pad sector.

Tilted Pad

In a tilted pad journal bearing, the bearing surface is described by multiple pads, similar to the multilobe bearings. The difference is that the pads in this case are free to tilt. Tilting of the pad can occur either about an axis parallel to the bearing axis, called a *line pivot* configuration, or about both axial and circumferential directions of the bearing. The latter is called a *point pivot* configuration. Therefore, the film thickness

in this case is also a function of the pad tilt angle. A sketch of the tilted pad bearing is shown in [Figure 6-11](#):

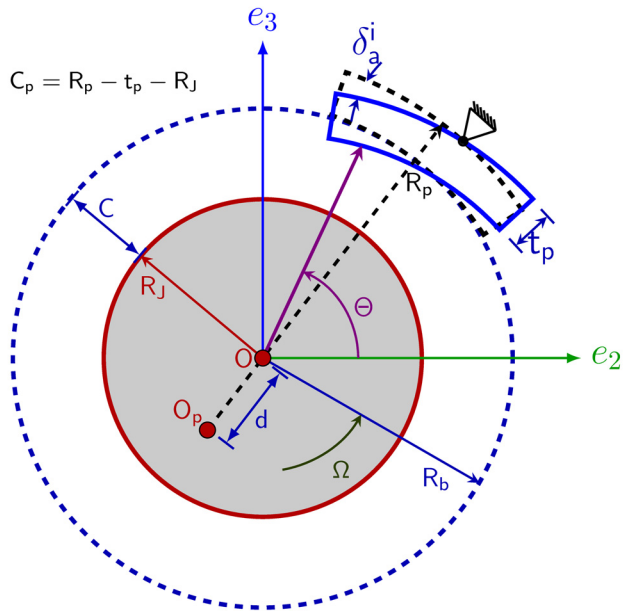

Figure 6-11: Tilted pad journal bearing.

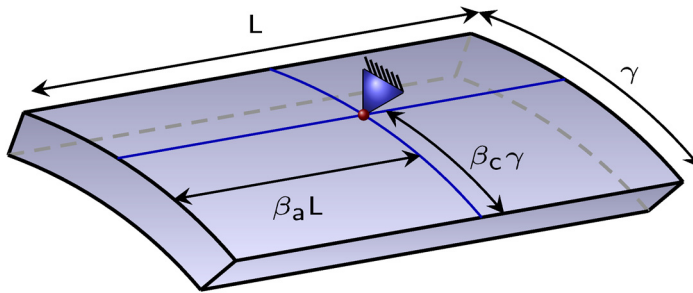

Figure 6-12: Pad geometry

As an effect of the loading, the bearing pads tilt by angles δ_a^i and δ_c^i about the axial and circumferential directions, respectively. The film thickness for the tilted pad bearing including the effect of the pad tilting is given by:

$$h_{b1}^i = C_p - (C_p - C_b) \cos(\Theta - \Theta_m^i) - \delta_a^i [(C_p - C_b) \sin(\Theta - \Theta_m^i) + (R_p + t_p) \sin(\Theta - \Theta_p^i)] - \delta_c^i [r_1 - (\beta_a - 0.5)L] \cos(\Theta - \Theta_p^i)$$

where Θ_p^i is the pivot point angle of the i^{th} pad from the local y direction. It is approximately given by

$$\Theta_p^i = (i - 1) \frac{2\pi}{N} + \beta_c \gamma$$

Here, Θ_m^i is the angle of the bisector line of the i^{th} pad from the local y direction and is given by

$$\Theta_m^i = (i - 1) \frac{2\pi}{N} + \frac{\gamma}{2}$$

Other parameters used in the film thickness expression are:

- $C_p = R_p - R_J - t_p$
- $C_b = R_b - R_J$
- $r_1 =$ Axial coordinate of the bearing from center
- $\beta_a =$ Axial offset factor of the pivot point from one end of the pad
- $\beta_c =$ Circumferential offset factor of the pivot point from the leading edge the pad
- $R_p =$ Pad outer radius
- $t_p =$ Pad thickness
- $L =$ Bearing length
- $\gamma =$ Pad sector angle
- $R_b =$ Bearing radius
- $R_J =$ Journal radius

For the line pivot case, terms containing δ_c^i are ignored in the thickness expression.

If the pad tilt angle is already known, it can directly be specified. In many cases, the tilting is not known a priori, but rather depends on the bearing load. Moment balance

for each pad due the pressure distribution of the film decides the tilt angle of the pad. The moment about the pivot point of the pad due to the film pressure is given by

$$\int_{S^i} (\mathbf{X}^i - \mathbf{X}_{pv}^i) \times p \mathbf{e}_r dS = 0$$

After simplification, this results into the following moment balance equations for the tilt about the axial and circumferential directions:

$$\delta_a^i : M_a^i = \int_{S^i} -p[(C_p - C) \sin(\Theta - \Theta_m^i) + R_p \sin(\Theta - \Theta_p^i)] dS = 0$$

$$\delta_c^i : M_c^i = \int_{S^i} p[r_1 - (\beta_p - 0.5)L] \cos(\Theta - \Theta_p^i) dS = 0$$

In the above moment balance equation, pad inertia is ignored. If pad inertia is also included, the moment balance equation is modified to

$$I_{aa} \frac{d^2 \delta_a^i}{dt^2} + I_{ac} \frac{d^2 \delta_c^i}{dt^2} = M_a^i$$

$$I_{ca} \frac{d^2 \delta_a^i}{dt^2} + I_{cc} \frac{d^2 \delta_c^i}{dt^2} = M_c^i$$

where

$$I_{aa} = m \left[\frac{3R_p^2 + (R_p - t_p)^2}{2} - \frac{4R_p(3R_p^2 - 3R_p t_p + t_p^2)}{3(2R_p - t_p)} \right] S$$

$$I_{cc} = m \left[\frac{L^2}{3} (1 - 3\beta_a + 3\beta_a^2) + \frac{5R_p^2 + (R_p - t_p)^2}{4} + \left\{ \frac{R_p^2 - (R_p - t_p)^2}{8} - \frac{4R_p(3R_p^2 - 3R_p t_p + t_p^2)}{3(2R_p - t_p)} \right\} S \right]$$

$$I_{ac} = \left(\rho(0.5 - \beta_a)L^2 \frac{R_p^3 - (R_p - t_p)^3}{3} \right) \{ \cos(1 - \beta_c)\gamma - \cos(\beta_c\gamma) \} = I_{ca}$$

are the components of the moment of inertia tensor of the pad about the pivot point expressed along local directions.

In the above expression, m is the mass of the pad given by

$$m = \rho\gamma L \left(\frac{2R_p t_p - t_p^2}{2} \right)$$

and

$$S = \frac{\sin(1 - \beta_c)\gamma + \sin(\beta_c\gamma)}{\gamma}$$

Expressions for the moment of inertia are derived by assuming that the shape of the pad is a sector of a hollow cylinder.

Sometimes the pads in the bearing are not completely free to tilt, but are spring loaded. In such a case, the equation of motion of the pad changes to

$$I_{aa} \frac{d^2 \delta_a^i}{dt^2} + I_{ac} \frac{d^2 \delta_c^i}{dt^2} + k_{aa} \delta_a^i + k_{ac} \delta_c^i = M_a^i$$

$$I_{ca} \frac{d^2 \delta_a^i}{dt^2} + I_{cc} \frac{d^2 \delta_c^i}{dt^2} + k_{ca} \delta_a^i + k_{cc} \delta_c^i = M_c^i$$

User Defined

You can also enter your own expression for the initial film thickness, if the bearing type does not match any of the predefined bearings.

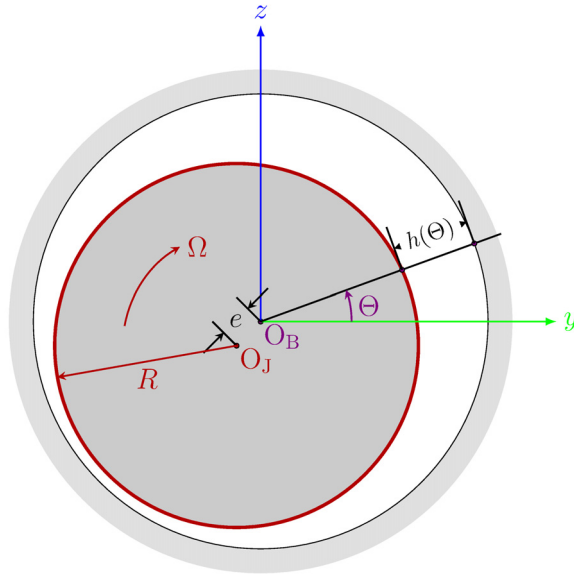

Figure 6-13: Definition of variables for a user-defined journal bearing.

Floating Ring Bearing

The floating ring bearing (FRB) is an extension of the plain journal bearing. An FRB typically consists of a journal, a bushing and a ring inserted between the journal and the bushing. As opposed to the plain journal bearing, in floating ring bearings there are two oil films formed in the bearing, the first between the journal and the ring (called inner film) and the second between the ring and the bushing (called outer film). The ring could be full-floating or semi-floating. In the full-floating case, the ring is free to rotate about the bearing axis due to the hydrodynamic shear forces on the ring. In semi-floating case, the axial rotation of the ring is suppressed, while it is free to perform in-plane motion between the journal and bushing. In the semi-floating case, the outer film does not have any significant spring action, but it provides damping to the ring motion.

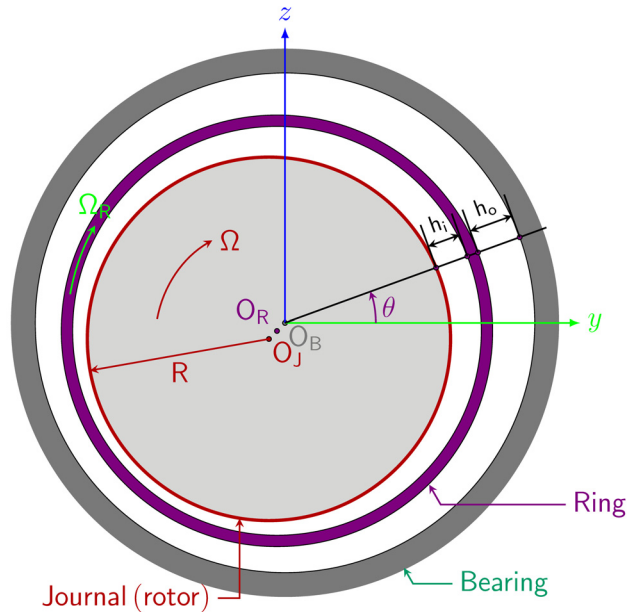

Figure 6-14: Sketch of a floating ring bearing

A complete description of the floating ring bearing requires the pressure distribution in both inner and outer films. It can be obtained by solving Reynolds equations for both films using the motion of journal, ring and bushing. However, the pressure

distribution in these films cannot be treated independently. The inner and outer films are generally connected through oil channels in the ring. The location of the oil channels relative to the inner and outer film keeps changing due to axial rotation of the ring. Specifying this connection for the pressure distribution in both the films in the stationary reference frame is difficult due to the changing locations of the channels. Therefore, for time-dependent calculations in the FRBs, the pressure distribution equations are formulated in a reference frame fixed to the ring. The advantage of such a description is that locations of the oil channels do not change in this reference frame. In the ring reference frame, the bushing rotates with an angular velocity $-\Omega_r$, and the shaft rotates with an angular velocity $\Omega - \Omega_r$. Ω_r is the angular velocity of the ring and Ω is the angular velocity of the journal in the stationary reference frame.

Reynolds Equation for the floating ring bearing takes the following form in the ring reference frame:

$$\frac{\partial}{\partial t}(\rho h) + \nabla_t(\rho h \mathbf{v}_{\text{avg}}) = 0$$

where h is the film thickness and \mathbf{v}_{avg} is the average velocity in the film. Expressions for film thickness and average velocity in both films are given below.

Inner film:

$$\begin{aligned} h &= h_j + h_{r, \text{in}} \\ h_j &= -\mathbf{u}_j \cdot \mathbf{n}_{\text{ref}} \\ h_{r, \text{in}} &= h_{r0} + \mathbf{u}_r \cdot \mathbf{n}_{\text{ref}} - \mathbf{u}_r \cdot \nabla_t h_{r0} \\ h_{r0} &= C_{\text{in}} \\ \mathbf{v}_{\text{avg}} &= \frac{1}{2}(\mathbf{v}_{j, t} + \mathbf{v}_{r, t}) - \frac{h^2}{12\mu} \nabla_t p \end{aligned}$$

Outer film:

$$\begin{aligned} h &= h_{r, \text{out}} + h_b \\ h_{r, \text{out}} &= -\mathbf{u}_r \cdot \mathbf{n}_{\text{ref}} \\ h_b &= h_{b0} + \mathbf{u}_b \cdot \mathbf{n}_{\text{ref}} - \mathbf{u}_b \cdot \nabla_t h_{b0} \\ h_{b0} &= C_{\text{out}} \\ \mathbf{v}_{\text{avg}} &= \frac{1}{2}(\mathbf{v}_{r, t} + \mathbf{v}_{b, t}) - \frac{h^2}{12\mu} \nabla_t p \end{aligned}$$

ρ and μ are the density and viscosity of the lubricant, respectively. \mathbf{v}_j , \mathbf{v}_r and \mathbf{v}_b are the velocities of the journal, ring and bushing, respectively, measured in the ring reference frame and are given by

$$\begin{aligned}\mathbf{v}_j &= \mathbf{v}_{jc} + (\Omega - \Omega_r) \times (\mathbf{X} - \mathbf{X}_c) \\ \mathbf{v}_r &= \mathbf{v}_{rc} \\ \mathbf{v}_b &= \mathbf{v}_{bc} - \Omega_r \times (\mathbf{X} - \mathbf{X}_c)\end{aligned}$$

Similarly, the displacement of the journal, ring, and bushing has to be referred to the ring frame of reference. In general, the relation between the displacement in the stationary and ring frames of reference is given by

$$\begin{bmatrix} u_1 \\ u_2 \\ u_3 \end{bmatrix} = \begin{bmatrix} 1 & 0 & 0 \\ 0 & \cos(\Omega_r t) & \sin(\Omega_r t) \\ 0 & -\sin(\Omega_r t) & \cos(\Omega_r t) \end{bmatrix} \begin{bmatrix} u_1 \\ u_2 \\ u_3 \end{bmatrix}_s$$

where subscript s denotes the quantity in the stationary frame.

Equations of Motion for the Ring

Let $\mathbf{f}_{r,in}$ and $\mathbf{f}_{r,out}$ be the distributed forces on the ring from the inner and outer films, respectively. Then total force and moment on the ring are

$$\begin{aligned}\mathbf{F}_r &= \int_S (\mathbf{f}_{r,in} + \mathbf{f}_{r,out}) dS \\ \mathbf{M}_r &= \int_S (\mathbf{X} - \mathbf{X}_c) \times (\mathbf{f}_{r,in} + \mathbf{f}_{r,out}) dS\end{aligned}$$

Let \mathbf{u}_c and θ_c be the displacement and rotations at the center of the ring. Then, the equations of motion can be written as

$$\begin{aligned}m_r \frac{d^2 \mathbf{u}_c}{dt^2} &= \mathbf{F}_r \\ I_r \frac{d^2 \theta_c}{dt^2} &= \mathbf{M}_r\end{aligned}$$

Connection Between Inner and Outer Film

The flows in the inner and outer films are connected through the channels in the rings. The oil that enters the channel from the outer film has to emerge in the inner film, assuming no accumulation in the oil channel. This gives the required condition for connecting the flow across both channels. In addition, correction pressure term are needed to account for the centrifugal forces. This results into the following conditions:

$$\begin{aligned}\frac{dQ}{dt} &= Q_{i,m} + Q_{o,m} = 0 \\ P_{i,m} &= P_{o,m} + P_{\text{cen}} \\ P_{\text{cen}} &= -\rho \frac{\Omega_r^2}{2} (R_i^2 - R_o^2)\end{aligned}$$

Here, the subscript m denotes the channel number. It is assumed that the mass transport through the channel is instantaneous. The feed pressure $P_{o,m}$ can be determined iteratively to satisfy the flow balance. The flow rate at the inner film and outer film sides in the channel is determined by

$$\begin{aligned}Q_{i,m} &= \int_{L_{i,m}} \mathbf{v}_{\text{avg},i} \cdot \mathbf{n}_{\text{in}} dL \\ Q_{o,m} &= \int_{L_{o,m}} \mathbf{v}_{\text{avg},o} \cdot \mathbf{n}_{\text{out}} dL\end{aligned}$$

Here, $L_{i,m}$ and $L_{o,m}$ denote the outer edges of the ring hole in the inner and outer film respectively. \mathbf{n}_{in} and \mathbf{n}_{out} are the normals to the outer edges of the ring hole in the plane of the inner and outer films, respectively.

Initial Film Thickness in Thrust Bearings

A Thrust bearing is used to support the axial load on the rotor. It consists of a collar surface attached to the rotor, bearing pads and bearing base. Bearing pads can be rigidly connected to the bearing base or can be allowed to undergo certain motion relative to it. A lubricant is supplied between the collar and pads to avoid dry friction conditions and to reduce the frictional losses. Generally, the pads are arranged in such a way that there is a converging gap between the pad and the collar surface. This helps in generating the pressure in the fluid film due to the relative motion between the pad and collar. The pressure essentially keeps these surfaces separated. If the pressure is not high enough, the surfaces will come in direct contact with each other. Due to the different requirements in different applications there are many types of thrust bearings in common use. The initial film thickness profiles for some of the commonly used thrust bearings are discussed below:

Tilted Pad Bearing

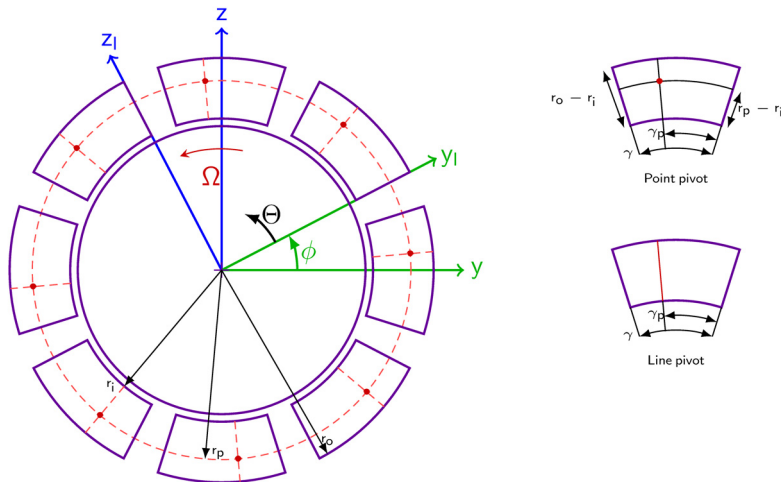

Figure 6-15: Tilted pad thrust bearing geometry.

A tilting pad bearing is a type of thrust bearing in which the oil wedge is created by the natural tilting of the pads due to the lubricant pressure. The tilting of the pad can occur about a radial axis in the line pivot configuration or about both radial and circumferential axis in the point pivot configuration. Tilting of the pad also provides the freedom to adjust for the misalignment of the rotor within the bearings. A typical bearing and pad geometry is shown in [Figure 6-15](#).

Oil grooves are provided between the pads to supply the lubricant. Therefore, sets of a pad and a groove are repeated in the circumferential direction making the bearing sector symmetric with the sector angle $2\pi/N$, where N is the number of the pads in the bearing. Let us consider a local y direction passing through the leading edge of one of the pads and let \mathbf{r}_c be the coordinate of the center of the bearing. Then for a point at position \mathbf{r} on the bearing pad, its radial and azimuthal coordinates are:

$$r = \sqrt{\{(\mathbf{r} - \mathbf{r}_c) \cdot \mathbf{e}_2\}^2 + \{(\mathbf{r} - \mathbf{r}_c) \cdot \mathbf{e}_3\}^2}$$

$$\Theta = \text{atan} \left\{ \frac{(\mathbf{r} - \mathbf{r}_c) \cdot \mathbf{e}_3}{(\mathbf{r} - \mathbf{r}_c) \cdot \mathbf{e}_2} \right\}$$

where \mathbf{e}_2 and \mathbf{e}_3 are the local directions in the bearing. The first pad on the bearing is then located between

$$r_i \leq r \leq r_o$$

$$0 \leq \Theta \leq \gamma$$

The i^{th} pad will therefore be located between

$$r_i \leq r \leq r_o$$

$$(i-1) \frac{2\pi}{N} \leq \Theta \leq (i-1) \frac{2\pi}{N} + \gamma$$

The groove sector angle can be obtained as

$$\gamma_g = \frac{2\pi}{N} - \gamma.$$

The location of the pivot is specified by the circumferential offset, β_c , and the radial offset, β_r , with

$$\beta_c = \frac{\gamma_p}{\gamma}$$

$$\beta_r = \frac{r_p - r_i}{r_o - r_i}$$

The location of the pivot point for the i^{th} pad from the bearing center is, in polar coordinates, given by

$$r_p^i = r_i + \beta_r(r_o - r_i)$$

$$\theta_p^i = (i - 1)\frac{2\pi}{N} + \beta_c\gamma$$

Denote the tilt angles of the i^{th} pad about the radial and circumferential directions by δ_r^i and δ_c^i , respectively. Assuming these tilt angles are small, the tilt vector can be written as

$$\delta = \delta_r^i \mathbf{e}_r^i + \delta_c^i \mathbf{e}_c^i$$

where

$$\mathbf{e}_r^i = \cos\theta_p^i \mathbf{e}_2 + \sin\theta_p^i \mathbf{e}_3$$

$$\mathbf{e}_c^i = -\sin\theta_p^i \mathbf{e}_2 + \cos\theta_p^i \mathbf{e}_3$$

are the radial and circumferential directions on the i^{th} pad. Due to tilting of the pad, the displacement at a point \mathbf{X} on the pad surface is

$$\mathbf{u}_p^i = \delta \times (\mathbf{X} - \mathbf{X}_p^i)$$

Here \mathbf{X}_p^i is the position vector of the pivot point of the i^{th} pad with respect to bearing center,

$$\mathbf{X}_p^i = r_p^i \mathbf{e}_r^i$$

The axial component of the displacement due to the tilting at a point on the pad will change the film thickness at that location, and is given by

$$u_{1p}^i = \mathbf{u}_p^i \cdot \mathbf{e}_1 = \delta_r^i \{(\mathbf{X} - \mathbf{X}_p^i) \cdot \mathbf{e}_c^i\} - \delta_c^i \{(\mathbf{X} - \mathbf{X}_p^i) \cdot \mathbf{e}_r^i\}$$

If the film thickness at the pivot point is h_p then the film thickness due to tilting at a point \mathbf{X} on the pad due to tilting will be

$$h = h_p \pm u_{1p}^i$$

where plus sign is used when the pad is along the positive axial direction from the collar surface and negative sign when the pad is along the negative axial direction from the collar surface.

Therefore, the film thickness variation in the i^{th} sector of symmetry is

$$\begin{cases} h = h_p \pm u_{1p}^i & r_i \leq r \leq r_o, (i-1)\frac{2\pi}{N} \leq \Theta < (i-1)\frac{2\pi}{N} + \gamma \\ h = h_g & r_i \leq r \leq r_o, (i-1)\frac{2\pi}{N} + \gamma \leq \Theta < i\frac{2\pi}{N} \end{cases}$$

In this expression for the film thickness, the tilt angles of the pad are unknown. They can be determined by balancing the moment on the pad caused by the pressure distribution. The moment balance on the pad has to be treated differently depending on the study type. For a stationary analysis, inertial effects are ignored, and thus the tilt angles are obtained by setting the net moment on each pad about the pivot point to zero.

$$\int_{S^i} (\mathbf{X} - \mathbf{X}_p^i) \times p \mathbf{n}_{\text{ref}} dS = 0$$

The reference surface normal is parallel to the axial direction but the direction of the normal could be either along or opposite to the axial direction. Using this fact, the moment equation reduces to

$$\pm \int_{S^i} p [\{(\mathbf{X} - \mathbf{X}_p^i) \cdot \mathbf{e}_c^i\} \mathbf{e}_r^i - \{(\mathbf{X} - \mathbf{X}_p^i) \cdot \mathbf{e}_r^i\} \mathbf{e}_c^i] dS = 0$$

where a plus sign is used if the reference surface normal is along the axial direction and a negative sign is used otherwise. This approach results in two equations, one along the radial direction and other along the circumferential direction. These equations basically determine the tilts δ_r^i and δ_c^i , respectively. In the line pivot case, only the radial direction equation is used.

In a time-dependent analysis, the inertia of the pads also play a role in the tilting motion. Including the pad inertia, the moment balance equations are modified to

$$I_{rr} \frac{d^2 \delta_r^i}{dt^2} + I_{r\theta} \frac{d^2 \delta_c^i}{dt^2} = \pm \int_{S^i} p \{ (\mathbf{X} - \mathbf{X}_p^i) \cdot \mathbf{e}_c^i \} dS$$

$$I_{\theta r} \frac{d^2 \delta_r^i}{dt^2} + I_{\theta\theta} \frac{d^2 \delta_c^i}{dt^2} = \mp \int_{S^i} p \{ (\mathbf{X} - \mathbf{X}_p^i) \cdot \mathbf{e}_r^i \} dS$$

For the pad with sector angle γ , inner radius r_i , outer radius r_o , and thickness t_p , and the pivot locations specified as above, the mass moment of inertia components about the pivot point are given by

$$I_{rr} = m \left[\left(\frac{r_o^2 + r_i^2}{4} \right) \left(1 - \frac{\sin \gamma}{\gamma} \cos 2(\gamma - 2\theta_p) \right) + \frac{t_p^2}{3} \right]$$

$$I_{\theta\theta} = m \left(\frac{r_o^2 + r_i^2}{4} + \frac{t_p^2}{3} + r_p^2 \right) +$$

$$\rho t_p \left[\frac{r_o^4 - r_i^4}{8} \sin \gamma \cos(\gamma - 2\theta_p) - \frac{4}{3} r_p (r_o^3 - r_i^3) \sin \frac{\gamma}{2} \cos \left(\frac{\gamma}{2} - \theta_p \right) \right]$$

$$I_{r\theta} = \rho t_p \left[\frac{r_o^4 - r_i^4}{8} \sin \gamma \sin(2\theta_p - \gamma) - \frac{2}{3} r_p (r_o^3 - r_i^3) \sin \frac{\gamma}{2} \sin \left(\theta_p - \frac{\gamma}{2} \right) \right]$$

SPRING LOADED PAD

Sometimes instead of pads being freely pivoted, they are mounted on springs. Then the external moment due to pressure distribution in the film is balanced by the spring moment. In the stationary case, this moment balance is

$$k_{rr} \delta_r^i + k_{r\theta} \delta_c^i = \pm \int_{S^i} p \{ (\mathbf{X} - \mathbf{X}_p^i) \cdot \mathbf{e}_c^i \} dS$$

$$k_{\theta r} \delta_r^i + k_{\theta\theta} \delta_c^i = \mp \int_{S^i} p \{ (\mathbf{X} - \mathbf{X}_p^i) \cdot \mathbf{e}_r^i \} dS$$

In a time-dependent analysis pad inertia is also included, giving

$$I_{rr} \frac{d^2 \delta_r^i}{dt^2} + I_{r\theta} \frac{d^2 \delta_c^i}{dt^2} + k_{rr} \delta_r^i + k_{r\theta} \delta_c^i = \pm \int_{S^i} p \{ (\mathbf{X} - \mathbf{X}_p^i) \cdot \mathbf{e}_c^i \} dS$$

$$I_{\theta r} \frac{d^2 \delta_r^i}{dt^2} + I_{\theta\theta} \frac{d^2 \delta_c^i}{dt^2} + k_{\theta r} \delta_r^i + k_{\theta\theta} \delta_c^i = \mp \int_{S^i} p \{ (\mathbf{X} - \mathbf{X}_p^i) \cdot \mathbf{e}_r^i \} dS$$

Tapered Land Bearing

Tapered land bearings, unlike the tilted pad bearings, have the pad fixed to the bearing base. The pad is tapered in order to create the natural oil wedge. Because of the fixed thickness profile, these bearings are designed for specific conditions. A typical pad of a tapered land bearing is shown in the [Figure 6-16](#).

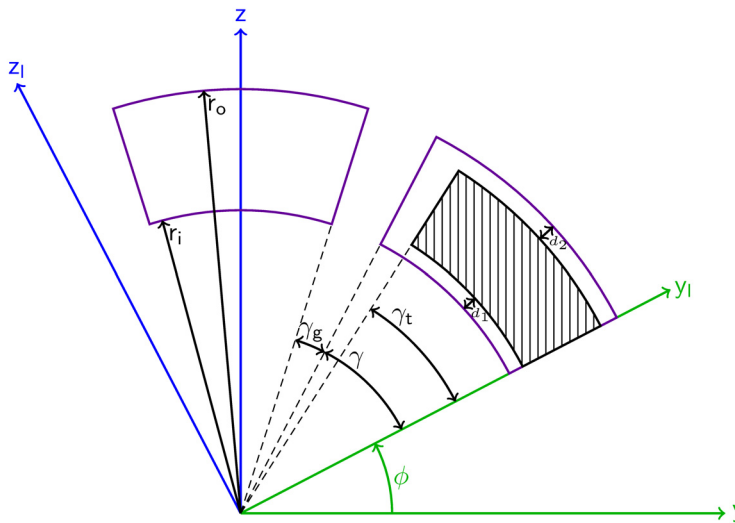

Figure 6-16: Geometry of a tapered land bearing.

The hatched area in the figure is the tapered area and rest of the area is flat. The flat areas near the inner and outer diameter edges are called inner and outer dam. The width of the inner and outer dams are d_1 and d_2 , respectively. The arc angle for the tapered area is γ_t . r_1 and r_o are the inner and outer radius of the pad, respectively. Two types of grooves are usually used in the tapered bearings: one in which the groove

makes a constant arc angle about the center as shown in the Figure 6-16 and the second in which the groove is of constant width as shown in Figure 6-17. On the tapered area, a linear variation of the thickness is assumed.

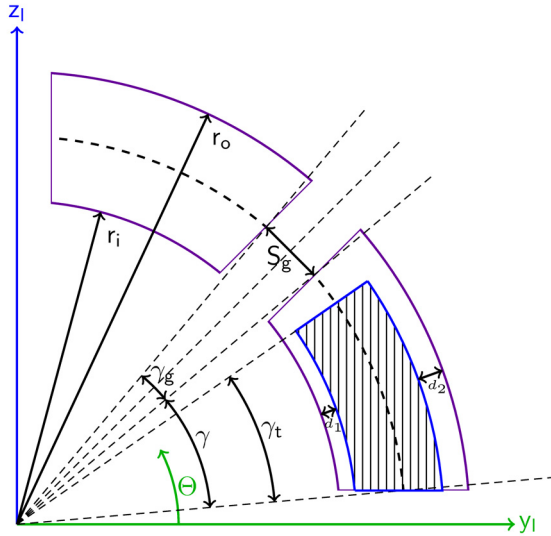

Figure 6-17: Geometry of the constant groove width tapered land bearing.

CONSTANT ARC GROOVE

The local y direction in the constant arc groove bearing is considered to be passing through the leading edge of the pad. If the initial clearance at the outer diameter side of the trailing edge is h_{te} , and the tapered depth on inner and outer diameter side is h_i and h_o , respectively, then the film thickness in the tapered area can be approximated as

$$h^i = h_{te} + h_o \left(\frac{\Theta_{t,te}^i - \Theta}{\gamma_t} \right) + (h_i - h_o) \left[\frac{r_o - d_2 - r}{(r_o - d_2) - (r_i + d_1)} \right]$$

where $\Theta_{t,te}^i$ is the azimuthal angle of the trailing edge side of the tapered area of the i^{th} pad from the local y direction, defined as

$$\Theta_{t,te}^i = (i - 1) \frac{2\pi}{N} + \gamma_t$$

Generally on the tapered land bearing, part of the area near the inner diameter and outer diameter is used as dam. Also the complete area in the circumferential direction is not tapered, rather some area near the trailing edge is left flat. Therefore, the film thickness variation on the i^{th} sector of symmetry can be given as

$$\left[\begin{array}{l} h = h^i \quad r_i + d_1 \leq r \leq r_o - d_2 \quad \text{and} \quad (i-1)\frac{2\pi}{N} \leq \Theta < (i-1)\frac{2\pi}{N} + \gamma_t \\ h = h_{te} \quad r_i + d_1 \leq r \leq r_o - d_2 \quad \text{and} \quad (i-1)\frac{2\pi}{N} + \gamma_t \leq \Theta < (i-1)\frac{2\pi}{N} + \gamma_p \\ h = h_g \quad r_i + d_1 \leq r \leq r_o - d_2 \quad \text{and} \quad (i-1)\frac{2\pi}{N} + \gamma_p \leq \Theta < i\frac{2\pi}{N} \\ h = h_g \quad r_i \leq r < r_i + d_1 \quad \text{or} \quad r_o - d_2 < r \leq r_o \end{array} \right]$$

Here, h_g is the depth of the groove.

CONSTANT WIDTH GROOVE

Determination of the film thickness profile in a constant width groove bearing requires the determination of the coordinates of various points on the pad surface. [Figure 6-18](#) shows the geometry of the pad in a constant width groove bearing in more detail.

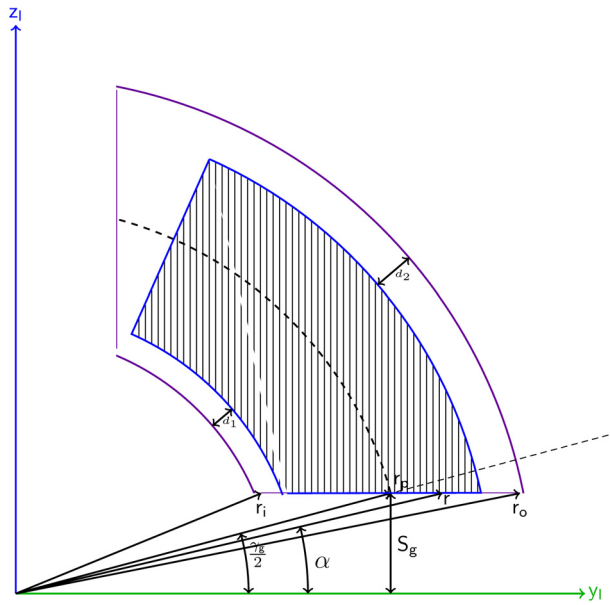

Figure 6-18: Geometry of the pad in a constant width groove bearing.

The local y direction is in this case considered to pass from the center of the groove as opposed to the leading edge of the pad in other cases.

From the triangle formed by the radial directions r_p and r

$$\frac{\sin\left(180^\circ - \frac{\gamma_g}{2}\right)}{r} = \frac{\sin\alpha}{r_p}$$

which gives

$$\alpha = \text{asin}\left(\frac{r_p}{r} \sin\frac{\gamma_g}{2}\right)$$

In the above expression, r can vary from the inner radius r_i to outer radius r_o . Since the pad depths at trailing edge outer diameter, and the relative depth of the pad from this location to the leading edge outer and inner diameter are known, the film

thickness variation in the tapered area can be calculated by assuming a linear variation in radial and circumferential directions:

$$h = h_0 + h_r r + h_\theta \Theta$$

The thicknesses h_0 , h_r , and h_θ are yet unknown. They can be determined by the following information:

$$h = \begin{cases} h_{te}; & r = r_o - d_2, \Theta = (i-1)\frac{2\pi}{N} + \frac{\gamma_g}{2} + \gamma_t \\ h_{te} + h_o; & r = r_o - d_2, \Theta = (i-1)\frac{2\pi}{N} + \alpha_o \\ h_{te} + h_i; & r = r_i + d_1, \Theta = (i-1)\frac{2\pi}{N} + \alpha_i \end{cases}$$

where

$$\alpha_o = \text{asin}\left(\frac{r_p}{r_o} \sin \frac{\gamma_g}{2}\right)$$

$$\alpha_i = \text{asin}\left(\frac{r_p}{r_i} \sin \frac{\gamma_g}{2}\right)$$

Using this information, the height variation in the tapered area of the i^{th} pad is calculated as

$$h^i = h_{te} - (h_o - h_i) \left[\frac{r_o - d_2 - r}{(r_o - d_2) - (r_i + d_1)} \right] + \frac{h_o}{\left(\frac{\gamma_g}{2} + \gamma_t - \alpha_o\right)} \left[(i-1)\frac{2\pi}{N} + \frac{\gamma_g}{2} + \gamma_t - \Theta - (\alpha_o - \alpha_i) \frac{r_o - d_2 - r}{(r_o - d_2) - (r_i + d_1)} \right]$$

Therefore, the film thickness profile within a sector of symmetry for the constant width groove tapered pad bearing is given by

$$\left[\begin{array}{l}
h = h_g \quad r_i + d_1 \leq r \leq r_o - d_2 \quad \text{and} \quad (i-1)\frac{2\pi}{N} \leq \Theta < (i-1)\frac{2\pi}{N} + \alpha \\
h = h^i \quad r_i + d_1 \leq r \leq r_o - d_2 \quad \text{and} \quad (i-1)\frac{2\pi}{N} + \alpha \leq \Theta < (i-1)\frac{2\pi}{N} + \frac{\gamma_g}{2} + \gamma_t \\
h = h_{te} \quad r_i + d_1 \leq r \leq r_o - d_2 \quad \text{and} \quad (i-1)\frac{2\pi}{N} + \frac{\gamma_g}{2} + \gamma_t \leq \Theta < i\frac{2\pi}{N} - \alpha \\
h = h_g \quad r_i + d_1 \leq r \leq r_o - d_2 \quad \text{and} \quad i\frac{2\pi}{N} - \alpha \leq \Theta < i\frac{2\pi}{N} \\
h = h_{te} \quad (r_i \leq r < r_i + d_1 \quad \text{or} \quad r_o - d_2 < r \leq r_o) \quad \text{and} \quad (i-1)\frac{2\pi}{N} + \alpha \leq \Theta < i\frac{2\pi}{N} - \alpha \\
h = h_g \quad (r_i \leq r < r_i + d_1 \quad \text{or} \quad r_o - d_2 < r \leq r_o) \quad \text{and} \\
\left((i-1)\frac{2\pi}{N} \leq \Theta < (i-1)\frac{2\pi}{N} + \alpha \quad \text{or} \quad i\frac{2\pi}{N} - \alpha \leq \Theta < i\frac{2\pi}{N} \right)
\end{array} \right]$$

The Hydrodynamic Bearing Interface

The **Hydrodynamic Bearing (hdb)** interface (🔧), found under the **Structural Mechanics>Rotordynamics** branch (🌀) when adding a physics interface, is intended for analysis of fluid film bearings in 3D, modeled using a surface geometry. It is assumed that the thickness of the film is very small. Different types of journal bearings, such as plain, elliptic, split halves, multilobe, and tilted pad bearings, can be modeled using the **Hydrodynamic Journal Bearing** feature in this interface. You can also model a bearing mounted on a foundation.

On one side of the boundary there is a journal surface and on the other a bearing surface, neither of which is represented in the geometry. The journal and bearing surfaces are orientated with respect to the reference surface normal, as shown in [Figure 6-19](#). Fluid flows in the gap between the journal and the bearing surfaces.

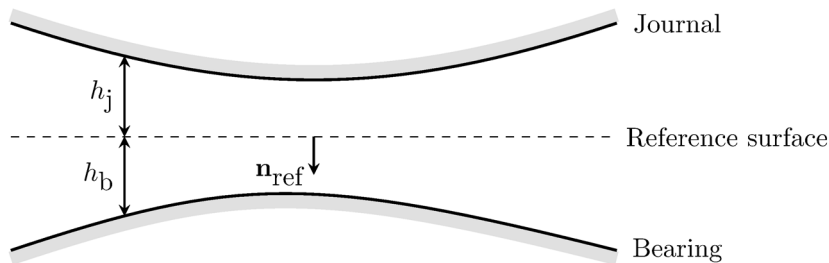

Figure 6-19: Diagram illustrating the orientation of the journal and the bearing surfaces with respect to the reference surface in the Hydrodynamic Bearing interface. A vector from the reference surface to the corresponding point on the journal always points in the $-\mathbf{n}_{\text{ref}}$ direction, where \mathbf{n}_{ref} is the reference surface normal. Similarly, a vector from the reference surface to the corresponding point on the bearing points in the $+\mathbf{n}_{\text{ref}}$ direction. The height of the journal above the reference surface (h_j) and the height of the bearing below the reference surface (h_b) are also shown in the figure.

Using equations on the reference surface, the Hydrodynamic Bearing interface computes the pressure in a narrow gap between the journal and the bearing. When modeling the flow, it is assumed that the total gap height, $h = h_j + h_b$, is much smaller

than the typical lateral dimension L of the reference surface. This physics interface is used to model laminar flow in thin gaps or channels in, for example, a lubricating oil between two rotating cylinders.

The **Hydrodynamic Journal Bearing** node is always added, with the **Plain** bearing as the default. This node adds the Reynolds equations for the pressure distribution on the film surface and has a Settings window to define the bearing properties. The equations in this feature also account for the velocity due to the axial rotation of the rotor.

When the **Hydrodynamic Bearing** interface is added, these default nodes are also added to the **Model Builder** — **Bearing Orientation** (the orientation of the bearing in the spatial frame), **Border** (a boundary condition where lubricant is assumed to flow out into a space filled with the same fluid), and **Initial Values**. Then, from the **Physics** toolbar, you can add features that implement other boundary conditions and bearing properties. You can also right-click **Hydrodynamic Bearing** to select physics features from the context menu.

SETTINGS

The **Label** is the default physics interface name.

The **Name** is used primarily as a scope prefix for variables defined by the physics interface. Refer to such physics interface variables in expressions using the pattern `<name>.<variable_name>`. In order to distinguish between variables belonging to different physics interfaces, the name string must be unique. Only letters, numbers, and underscores (`_`) are permitted in the **Name** field. The first character must be a letter.

The default **Name** (for the first physics interface in the model) is `hdb`.

PHYSICAL MODEL

Select an **Equation Type** — **Reynolds Equation** or **Modified Reynolds Equation**.

DYNAMIC COEFFICIENTS

Select the checkbox **Calculate dynamic coefficients** to enable the computation of equivalent stiffness and damping coefficients for the bearing.

CAVITATION

To display this section, click the **Show More Options** button () and select **Show Advanced Physics Options** in the **Show More Options** dialog box. Select the **Cavitation** check box to use when modeling bearings and then enter **Cavitation transition width**. This section is only available when the **Reynolds Equation** model is selected in the **Physical Model** section.

Under normal operating conditions, the gases dissolved in the lubricant cause cavitation in the diverging clearance between the journal and the bearing. This happens because the pressure in the lubricant drops below the saturation pressure.

See the theory for [Cavitation](#) for more information.

INCONSISTENT STABILIZATION

To display this section, click on **Show More Options** button () and select **Stabilization** in the **Show More Options** dialog box. Select the **Isotropic diffusion** check box to include the stabilization of the Reynolds equation with cavitation and then enter a **Tuning parameter** value. A larger value of the tuning parameter increases the amount of isotropic diffusion in the system. This section is only available when **Cavitation** is selected in the **Cavitation** section.

REFERENCE PRESSURE

Enter a **Reference pressure level** p_{ref} . The default value is 1 [atm]. This pressure represents the ambient pressure, which is not accounted for when computing fluid loads.

DEPENDENT VARIABLES

The dependent variable (field variable) is the **Pressure** p_f . The name can be changed but the names of fields and dependent variables must be unique within a component.

DISCRETIZATION

Select the **Pressure** discretization — **Linear**, **Quadratic**, **Cubic** or **Quartic** to change the order of the shape functions for the pressure.

Domain, Boundary, and Pair Nodes for the Hydrodynamic Bearing Interface

The [Hydrodynamic Bearing Interface](#) has boundary, edge, and pair nodes (and subnodes), listed in alphabetical order, available from the **Physics** ribbon toolbar (Windows users), **Physics** context menu (Mac or Linux users), or by right-clicking the main physics interface node to access the context menu (all users).

LINKS TO FEATURE NODE INFORMATION

These nodes (and subnodes) are described in this section (listed in alphabetical order):

- Bearing Orientation
- Border
- Floating Ring Bearing
- Hydrodynamic Journal Bearing
- Hydrodynamic Thrust Bearing
- Initial Values
- Inlet
- Inner Film Properties
- Inner-Outer Film Connection
- Outer Film Properties
- Outlet
- Squeeze Film Damper
- Symmetry
- Wall



In the *COMSOL Multiphysics Reference Manual* see [Table 2-4](#) for links to common sections and [Table 2-5](#) to common feature nodes. You can also search for information: press F1 to open the **Help** window or Ctrl+F1 to open the **Documentation** window.



In general, to add a node, go to the **Physics** toolbar, no matter what operating system you are using. Subnodes are available by clicking the parent node and selecting it from the **Attributes** menu.



The links to the nodes described in external guides, such as the *Structural Mechanics Module User's Guide*, do not work in the PDF, only from the online help in COMSOL Multiphysics.

Hydrodynamic Journal Bearing

In the **Hydrodynamic Journal Bearing** node you specify the geometric dimensions, journal and foundation motion and lubricant properties necessary to model the fluid-film journal bearing.

BEARING PROPERTIES

Select **Bearing type** — **Plain**, **Elliptic**, **Split halves**, **Multilobe**, **Tilted pad**, or **User defined**. Then, go to the relevant section below to continue defining the properties.

Plain

Enter the **Clearance**, C , between the journal and bearing when the centers of the journal and bearing coincide.

Elliptic

Enter the **Minimum clearance**, C_{\min} , and **Maximum clearance**, C_{\max} , when the centers of the journal and bearing coincide.

Split Halves

Enter a **Clearance**, C , and select the **Preload factor** — **Specify** or **Compute from offset**.

- **Specify**: enter a value of the preload factor m_p between 0 and 1.
- **Compute from offset**: enter the **Pad center offset**, d .

Multilobe

Enter a **Clearance**, C , and select the **Preload factor** — **Specify** or **Compute from offset**.

- **Specify**: enter the value of the preload factor m_p between 0 and 1.
- **Compute from offset**: enter the **Pad center offset**, d .

Finally, enter the **Number of pads**, N .

Tilted Pad

Enter a **Clearance**, C , and select the **Preload factor** — **Specify** or **Compute from pad clearance**.

- **Specify**: enter the value of the preload factor m_p between 0 and 1.
- **Compute from pad clearance**: enter the **Pad clearance**, C_p .

Finally, enter the **Number of pads**, N ; **Pad outer radius**, R_p ; **Pad tilt angle**, δ ; and **Pivot offset factor**, f .

User Defined

Enter the **Height of the bearing above reference plane** as a function of the polar coordinates. The default expression contains variables `<phys>.r_e1` and `<phys>.Th`, which are the axial and azimuthal coordinates of the reference surface. `<phys>.r_e1` is the coordinate of a point on the bearing surface along the bearing axis. `<phys>.Th` is the azimuth angle of a point on the bearing surface with respect to the local y direction of the bearing.

Select one of the **Moving** or **Flexible** foundation options. In both the cases, respective subnodes [Moving Foundation](#) or [Flexible Foundation](#) are automatically added.

JOURNAL PROPERTIES

Select **Specify** — **Displacement** or **Load**. If **Displacement** is selected, select **Journal displacement** — **User defined** and enter the displacement values.



The **Journal displacement** list normally only contains **User defined**. When combined with another physics interface that can provide this type of displacement, it is also possible to choose a predefined displacement from this list.

If **Load** is selected, select **Journal Load** — **User defined** and enter the load values.



The **Journal load** list normally only contains **User defined**. When combined with another physics interface that can provide this type of force, it is also possible to choose a predefined load from this list.

Enter the values for **Mass of the journal**. Also enter the value for the **Initial journal displacement**. Both are generally needed for a time-dependent study. In a stationary study, **Initial journal displacement** is used as an initial guess for the journal displacement.

Select **Velocity of the journal** — **Angular speed** or **Velocity field**. In the **Angular speed** case, select **User defined**, and enter the angular speed.



The **Angular speed** list normally only contains **User defined**. When combined with another physics interface that can provide this type of data, for example **Solid Rotor** and **Beam Rotor** interfaces, it is also possible to choose a predefined angular speed from this list.

In the **Velocity field** case, select **User defined**, and enter the velocity field of the journal.



The **Velocity field** list normally only contains **User defined**. When combined with another physics interface that can provide this type of data, it is also possible to choose a predefined velocity field from this list.

FILM BOUNDARY CONDITION

This section is only available for some of the **Physical Model** settings in the **Hydrodynamic Bearing** interface:

- **Equation type** is **Reynolds equation** and **Cavitation** is not selected in the **Cavitation** section.
- **Equation type** is **Modified Reynolds equation**

Select the **Film type** — **Sommerfeld** or **Gümbel**. In the Sommerfeld case, a complete 2π film is considered in the net force calculation in the bearing. In the Gümbel case, only half of the film where the pressure is positive (π film) is used for computing the net force in the bearing.

FLUID PROPERTIES

The default **Dynamic viscosity** μ is taken **From material**. For **User defined**, enter a different value or expression.

With the default options, the **Density** ρ is taken **From material**. For **User defined** enter a different value or expression. If the **Modified Reynolds Equation** is being solved, the density is determined automatically by the ideal gas law. If cavitation is enabled, the density is assumed to take the form $\rho = \rho_c \exp(\beta p_f)$, where p_f is the fluid pressure, ρ_c is the density at the cavitation pressure, and β is the compressibility. In this case, enter the values for the **Density at cavitation pressure**, ρ_c , and the **Compressibility**, β .

FILM FLOW MODEL

Select a **Film flow model** — **No-slip walls**, **Slip at walls**, **User defined-relative flow function**, or **User defined-general**. The film flow model is used to compute the mean fluid velocity as a function of the pressure gradient, the journal velocity, and the bearing velocity. Within the gap, the fluid velocity profile is a linear combination of the Poiseuille and Couette velocity profiles.

No-slip walls

This flow model assumes no slip at the journal and bearing surfaces. Thus, the average fluid velocity is computed by assuming that the fluid velocity at the journal and bearing is equal to the journal and bearing velocity, respectively.

Slip at walls

Use **Slip at walls** when slip occurs at the journal or bearing. In this case, the difference between the journal or bearing velocity and the fluid velocity is proportional to the tangential part of the normal stress tensor component. The slip length divided by the fluid viscosity is the constant of proportionality in this relationship. The mean fluid

velocity is computed using this assumption, given the pressure gradient and the journal and bearing velocities.

Enter a **Slip length, journal**, L_{sj} . Select the **Use different slip length for bearing** check box to enter a **Slip length, bearing**, L_{sb} .

For the **Modified Reynolds Equation** it is possible to use the gas mean free path to specify the slip length. Change the **Type of slip** setting (which defaults to **Slip length** with the settings described above) to **Mean free path and same accommodation coefficients** or to **Mean free path and different accommodation coefficients**.

- For **Mean free path and same accommodation coefficients**, enter a value for the **Journal and bearing accommodation coefficient**, α .
- For **Mean free path and different accommodation coefficients**, enter values for the **Journal accommodation coefficient**, α_j , and the **Bearing accommodation coefficient**, α_b .

Select an option to define the **Mean free path** — **Compute from material properties**, **User defined expression**, or **User defined with reference pressure**.

- For **User defined expression**, enter an expression for the **Mean free path**, λ . The default expression is $((70[\text{nm}]) * (1[\text{atm}])) / (\text{hdb}.\text{ptot})$.
- For **User defined with reference pressure**, enter values for the **Mean free path at reference pressure**, λ_0 , and for the **Mean free path reference pressure**, $p_{\lambda 0}$.

Rarefied-total accommodation (Modified Reynolds Equation Only)

The **Rarefied-total accommodation** option provides a rarefied gas model that assumes total accommodation at the journal and the bearing. This model is accurate to within 5% over the range $0 < \text{Kn} < 880$ (here Kn is the Knudsen number, which is the ratio of the film thickness to the mean free path). An empirical function, fitted to stationary solutions of the Boltzmann equation, is used to define the Poiseuille component of the flow.

Select an option to define the **Mean free path** — **Compute from material properties**, **User-defined expression**, or **User defined with reference pressure**.

- For **User-defined expression**, enter an expression for the **Mean free path**, λ . The default expression is $((70[\text{nm}]) * (1[\text{atm}])) / (\text{hdb}.\text{ptot})$.
- For **User defined with reference pressure**, enter values for the **Mean free path at reference pressure**, λ_0 , and for the **Mean free path reference pressure**, $p_{\lambda 0}$.

To select a **Force model**, choose:

- **Normal (pressure) forces only** to include only the normal pressure forces in the model.
- **Couette (slide film) forces only** to include only the shear forces generated from an empirical model of the rarefied flow developed for pure Couette flows.
- **Shear and normal forces** to include both the shear and pressure forces, combining the other two force models.

Rarefied-general accommodation (Modified Reynolds Equation Only)

The **Rarefied-general accommodation** option provides a rarefied gas model that assumes the same accommodation coefficient, α , at the journal and bearing. This model is accurate to within 1% over the ranges $0.7 < \alpha < 1$ and $0.01 < \text{Kn} < 100$ (here, Kn is the Knudsen number, which is the ratio of the film thickness to the mean free path). An empirical function, fitted to stationary solutions of the Boltzmann equation, is used to define the Poiseuille component of the flow.

Select an option to define the **Mean free path** — **Compute from material properties**, **User-defined expression**, or **User defined with reference pressure**.

- For **User-defined expression**, enter an expression for the **Mean free path**, λ . The default expression is $70[\text{nm}] * 1[\text{atm}] / \text{hdb.ptot}$.
- For **User defined with reference pressure**, enter values for the **Mean free path at reference pressure**, λ_0 , and for the **Mean free path reference pressure**, $p_{\lambda 0}$.

To select a **Force model**, choose:

- **Normal (pressure) forces only** to include only the normal pressure forces in the model.
- **Couette (slide film) forces only** to include only the shear forces generated from an empirical model of the rarefied flow developed for pure Couette flows.
- **Shear and normal forces** to include both the shear and pressure forces, combining the other two force models.

User defined-relative flow function

The **User defined-relative flow function** option enables user-defined models in which an effective fluid viscosity is employed. The fluid viscosity is divided by an additional factor Q_{ch} , which can be defined as an arbitrary expression in the user interface. It is also possible to define the expressions for the fluid forces on the journal and on the bearing (these are included as feature inputs in other physics interfaces).

Enter values or expressions for:

- **Relative flow rate function**, Q_c
- **Fluid load on journal**, \mathbf{f}_j
- **Fluid load on bearing**, \mathbf{f}_b

User defined-general

The **User defined-general** option enables you to define arbitrary flow models. Both the Poiseuille and Couette terms in the mean velocity can be defined arbitrarily. It is also possible to define the expressions for the fluid forces on the journal and on the bearing, (these are included as feature inputs in other physics interfaces).

Enter values or expressions for:

- **Poiseuille mean fluid velocity coefficient**, $u_{ave,P}$.
- **Couette mean fluid velocity component**, $\mathbf{v}_{ave,C}$.
- **Fluid load on journal**, \mathbf{f}_j .
- **Fluid load on bearing**, \mathbf{f}_b .

Floating Ring Bearing

In the **Floating Ring Bearing** node you specify the journal and foundation motion, ring properties and lubricant properties necessary to model a floating ring bearing.

BEARING PROPERTIES

Select **Ring type** — **Full floating** or **Semi floating**. In the **Full floating** case, the ring is allowed to axially rotate under the viscous drag force from the lubricant film in addition to the in plane translation and tilting rotation. In the **Semi floating** case, axial rotation of the ring is not allowed. The ring is, however, still free to move in-plane and to tilt about the lateral axes. Select **Ring position and orientation** — **Automatic** or **User defined**. In the **Automatic** case, enter the value of **Mass**, m_{ring} and **Moment of inertia**, I_{ring} of the ring. The motion of the ring is then computed by momentum and angular momentum balance. In the **User defined** case, enter the values of the displacement $u_{r,y}$ and $u_{r,z}$, as well as tilting rotation $\theta_{r,y}$ and $\theta_{r,z}$. In **Full floating** case, also select **Ring speed** — **Automatic** or **User defined**. If **Automatic** is selected, enter the value of **Polar moment of inertia**, $I_{p,ring}$ (only if **Ring position and orientation** is **User defined**). In the **User defined** case, enter the value of **Ring to journal speed ratio**, v_r .

Select one of the **Moving** or **Flexible** foundation options. In these cases, one of the subnodes [Moving Foundation](#) or [Flexible Foundation](#) is automatically added.

JOURNAL PROPERTIES

Select **Specify — Displacement** or **Load**. Then, go to the relevant section below to continue defining the properties.

Displacement

Select **Journal displacement — User defined** and enter the displacement values, \mathbf{u}_j .



The **Journal displacement** list normally only contains **User defined**. When combined with another physics interface that can provide this type of displacement, it is also possible to choose a predefined displacement from this list.

Load

Select **Journal Load — User defined** and enter the load values, \mathbf{W}_j .



The **Journal load** list normally only contains **User defined**. When combined with another physics interface that can provide this type of force, it is also possible to choose a predefined load from this list.

Enter the values for the **Mass of the journal**, m_j . Also enter the value for the **Initial journal displacement**, \mathbf{u}_{j0} . Both are generally needed for a time-dependent study. In a stationary study, **Initial journal displacement** is taken as an initial guess for the journal displacement.

Select **Velocity of the journal — Angular speed** or **Velocity field**. In the **Angular speed** case, select **User defined**, and enter the angular speed.



The **Angular speed** list normally only contains **User defined**. When combined with another physics interface that can provide this type of data, for example **Solid Rotor** and **Beam Rotor** interfaces, it is also possible to choose a predefined angular speed from this list.

In the **Velocity field** case, select **User defined**, and enter the velocity field of the journal.



The **Velocity field** list normally only contains **User defined**. When combined with another physics interface that can provide this type of data, it is also possible to choose a predefined velocity field from this list.

FILM BOUNDARY CONDITION

This section is only available for some of the **Physical Model** settings in the **Hydrodynamic Bearing** interface:

- **Equation type** is **Reynolds equation** and **Cavitation** is not selected in the **Cavitation** section.
- **Equation type** is **Modified Reynolds equation**

Select the **Film type** — **Sommerfeld** or **Gümbel**. In the Sommerfeld case, a complete 2π film is considered in the net force calculation in the bearing. In the Gümbel case, only half of the film where the pressure is positive (π film) is used for computing the net force in the bearing.

FLUID PROPERTIES

The default **Dynamic viscosity**, μ , is taken **From material**. For **User defined**, enter a different value or expression.

With the default options, the **Density** ρ is taken **From material**. For **User defined** enter a different value or expression. If the **Modified Reynolds Equation** is being solved, the density is determined automatically by the ideal gas law. If cavitation is enabled, the density is assumed to take the form $\rho = \rho_c \exp(\beta p_f)$, where p_f is the fluid pressure, ρ_c is the density at the cavitation pressure, and β is the compressibility. In this case, enter the values for the **Density at cavitation pressure**, ρ_c , and the **Compressibility** β .



Two default subnodes **Inner Film Properties** and **Outer Film Properties** are automatically added below the **Floating Ring Bearing** feature to specify the clearance and flow models of the respective films.

Inner Film Properties

The **Inner Film Properties** node can be used to specify the clearance and slip models for the inner film.

REFERENCE SURFACE PROPERTIES

The journal surface in the inner film is considered as reference surface. Select **Reference normal orientation** — **Same direction as geometry normal** or **Opposite direction to geometry normal** to specify the normal of the reference surface towards the lubricant film.

CLEARANCE

Enter the value of the **Clearance**, C .

FILM FLOW MODEL

Select **Film flow model** — **No-slip walls** or **Slip at walls**. In the **Slip at walls** case, enter the values of **Slip length, journal**, L_{sj} and **Slip length, ring**, L_{sr} .

Outer Film Properties

The **Outer Film Properties** node can be used to specify the clearance and slip models for the outer film.

REFERENCE SURFACE PROPERTIES

The ring surface in the outer film is considered as reference surface. Select **Reference normal orientation** — **Same direction as geometry normal** or **Opposite direction to geometry normal** to specify the normal of the reference surface towards the lubricant film.

CLEARANCE

Enter the value of the **Clearance**, C .

FILM FLOW MODEL

Select **Film flow model** — **No-slip walls** or **Slip at walls**. In the **Slip at walls** case, enter the values of **Slip length, ring**, L_{sr} and **Slip length, bearing**, L_{sb} .

Inner-Outer Film Connection

The **Inner-Outer Film Connection** node is optional, and can be used to connect the flow in the inner and outer film through the oil channels present in the ring. This requires the channel hole location in the inner and outer film and their relative circumferential offset to establish the connection.

CHANNEL, INNER FILM

Select the surfaces representing the channel hole in the inner film.

CHANNEL, OUTER FILM

Select the surfaces representing the channel hole in the outer film.

CHANNEL HOLE OFFSET

Enter the **Channel hole offset angle**, Θ_{off} to specify the relative circumferential offset between the channel hole location in inner and outer film.

Hydrodynamic Thrust Bearing

In the **Hydrodynamic Thrust Bearing** node you specify the geometric dimensions, collar and foundation motion and lubricant properties necessary to model a fluid-film thrust bearing.

REFERENCE SURFACE PROPERTIES

The collar surface is considered as reference surface. Select **Reference normal orientation** — **Same direction as geometry normal** or **Opposite direction to geometry normal** to specify the normal of the collar towards the lubricant film.

BEARING PROPERTIES

Select **Bearing type** — **Tilted pad**, **Tapered**, or **User defined**. Then, go to the relevant section below to continue defining the properties.

Tilted pad

Enter the **Number of pads**, N , **Pad arc**, γ_p , **Inner diameter**, d_i , and **Outer diameter**, d_o to define the pad geometry. Select the **Include pad inertia** check box to model the effect of pad inertia when determining the film thickness. Inertial effects are important only in a time-dependent study. If selected, enter the **Pad thickness**, t_p and **Density**, ρ to determine the moment of inertia of the pad. Finally enter the **Groove depth**, h_g which is used to determine the film thickness in the groove.

Tapered

Enter the **Number of pads**, N , **Pad arc**, γ_p , **Inner diameter**, d_i , **Outer diameter**, d_o and **Groove depth**, h_g to define the pad geometry. Finally select **Groove type** — **Constant width** or **Constant arc**.

User defined

Enter the **Initial clearance** as a function of the polar coordinates. The default expression contains variables $\langle \text{phys} \rangle .rd$ and $\langle \text{phys} \rangle .Th$, which are the radial and azimuthal coordinates of the reference surface. $\langle \text{phys} \rangle .rd$ is the radial coordinate of a point on the bearing surface with respect to bearing center. $\langle \text{phys} \rangle .Th$ is the azimuthal angle of a point on the bearing surface with respect to the local y direction of the bearing.

Select one of the **Moving** or **Flexible** foundation options. A subnode [Moving Foundation](#) or [Flexible Foundation](#) is automatically added.

COLLAR PROPERTIES

Select **Collar displacement** — **User defined** and enter the displacement values.



The **Collar displacement** list normally only contains **User defined**. When combined with another physics interface that can provide this type of displacement, it is also possible to choose a predefined displacement from this list.

Select **Velocity of the collar** — **Angular speed** or **Velocity field**. In the **Angular speed** case, select **User defined**, and enter the angular speed.



The **Angular speed** list normally only contains **User defined**. When combined with another physics interface that can provide this type of data, for example **Solid Rotor** and **Beam Rotor** interfaces, it is also possible to choose a predefined angular speed from this list.

In the **Velocity field** case, select **User defined**, and enter the velocity field of the journal.



The **Velocity field** list normally only contains **User defined**. When combined with another physics interface that can provide this type of data, it is also possible to choose a predefined velocity field from this list.

FILM BOUNDARY CONDITION

This section is only available for some of the **Physical Model** settings in the **Hydrodynamic Bearing** interface:

- **Equation type** is **Reynolds equation** and **Cavitation** is not selected in the **Cavitation** section.
- **Equation type** is **Modified Reynolds equation**

Select the **Film type** — **Sommerfeld** or **Gümbel**. In the Sommerfeld case, a complete 2π film is considered in the net force calculation in the bearing. In the Gümbel case, only half of the film where the pressure is positive (π film) is used for computing the net force in the bearing.

FLUID PROPERTIES

The default **Dynamic viscosity** μ is taken **From material**. For **User defined**, enter a different value or expression.

With the default options, the **Density**, ρ , is taken **From material**. For **User defined** enter a different value or expression. If the **Modified Reynolds Equation** is being solved, the density is determined automatically by the ideal gas law. If cavitation is enabled, the density is assumed to take the form $\rho = \rho_c \exp(\beta p_f)$, where p_f is the fluid pressure, ρ_c is the density at the cavitation pressure, and β is the compressibility. In this case, enter the values for the **Density at cavitation pressure**, ρ_c , and the **Compressibility** β .

FILM FLOW MODEL

Select a **Film flow model** — **No-slip walls**, **Slip at walls**, **User defined-relative flow function**, or **User defined-general**. The film flow model is used to compute the mean fluid velocity as a function of the pressure gradient, the collar velocity, and the bearing velocity. Within the gap, the fluid velocity profile is a linear combination of the Poiseuille and Couette velocity profiles.

No-slip walls

This flow model assumes no slip at both the collar and bearing surfaces. Thus, the average fluid velocity is computed by assuming that the fluid velocity at the collar and bearing is equal to the collar and bearing velocity, respectively.

Slip at walls

Use **Slip at walls** when slip occurs at the collar or bearing. In this case, the difference between the collar or bearing velocity and the fluid velocity is proportional to the tangential part of the normal stress tensor component. The slip length divided by the fluid viscosity is the constant of proportionality in this relationship. The mean fluid velocity is computed using this assumption, given the pressure gradient and the collar and bearing velocities.

Enter a **Slip length, collar**, L_{sc} . Select the **Use different slip length for bearing** check box to enter a **Slip length, bearing**, L_{sb} .

For the **Modified Reynolds Equation** it is possible to use the gas mean free path to specify the slip length. Change the **Type of slip** setting (which defaults to **Slip length** with the settings described above) to **Mean free path and same accommodation coefficients** or to **Mean free path and different accommodation coefficients**.

- For **Mean free path and same accommodation coefficients**, enter a value for the **Collar and bearing accommodation coefficient**, α .
- For **Mean free path and different accommodation coefficients**, enter values for the **Collar accommodation coefficient**, α_c , and the **Bearing accommodation coefficient**, α_b .

Select an option to define the **Mean free path** — **Compute from material properties**, **User defined expression**, or **User defined with reference pressure**.

- For **User defined expression**, enter an expression for the **Mean free path**, λ . The default expression is $((70[\text{nm}]) * (1[\text{atm}])) / (\text{hdb.ptot})$.
- For **User defined with reference pressure**, enter values for the **Mean free path at reference pressure**, λ_0 , and for the **Mean free path reference pressure**, $p_{\lambda 0}$.

Rarefied-total accommodation (Modified Reynolds Equation Only)

The **Rarefied-total accommodation** option provides a rarefied gas model that assumes total accommodation at the collar and the bearing. This model is accurate to within 5% over the range $0 < \text{Kn} < 880$ (here Kn is the Knudsen number, which is the ratio of the film thickness to the mean free path). An empirical function, fitted to stationary solutions of the Boltzmann equation, is used to define the Poiseuille component of the flow.

Select an option to define the **Mean free path** — **Compute from material properties**, **User-defined expression**, or **User defined with reference pressure**.

- For **User-defined expression**, enter an expression for the **Mean free path**, λ . The default expression is $((70[\text{nm}]) * (1[\text{atm}])) / (\text{hdb.ptot})$.
- For **User defined with reference pressure**, enter values for the **Mean free path at reference pressure**, λ_0 , and for the **Mean free path reference pressure**, $p_{\lambda 0}$.

To select a **Force model**, choose:

- **Normal (pressure) forces only** to include only the normal pressure forces in the model.
- **Couette (slide film) forces only** to include only the shear forces generated from an empirical model of the rarefied flow developed for pure Couette flows.
- **Shear and normal forces** to include both the shear and pressure forces, combining the other two force models.

Rarefied-general accommodation (Modified Reynolds Equation Only)

The **Rarefied-general accommodation** option provides a rarefied gas model that assumes the same accommodation coefficient, α , at the journal and bearing. This model is accurate to within 1% over the ranges $0.7 < \alpha < 1$ and $0.01 < \text{Kn} < 100$ (here, Kn is the Knudsen number, which is the ratio of the film thickness to the mean free path). An empirical function, fitted to stationary solutions of the Boltzmann equation, is used to define the Poiseuille component of the flow.

Select an option to define the **Mean free path** — **Compute from material properties**, **User-defined expression**, or **User defined with reference pressure**.

- For **User-defined expression**, enter an expression for the **Mean free path**, λ . The default expression is $70[\text{nm}] * 1[\text{atm}] / \text{hdb.ptot}$.
- For **User defined with reference pressure**, enter values for the **Mean free path at reference pressure**, λ_0 , and for the **Mean free path reference pressure**, $p_{\lambda 0}$.

To select a **Force model**, choose:

- **Normal (pressure) forces only** to include only the normal pressure forces in the model.
- **Couette (slide film) forces only** to include only the shear forces generated from an empirical model of the rarefied flow developed for pure Couette flows.
- **Shear and normal forces** to include both the shear and pressure forces, combining the other two force models.

User defined-relative flow function

The **User defined-relative flow function** option enables user-defined models in which an effective fluid viscosity is employed. The fluid viscosity is divided by an additional factor Q_{ch} , which can be defined as an arbitrary expression in the user interface. It is also possible to define the expressions for the fluid forces on the collar and on the bearing (these are included as feature inputs in other physics interfaces).

Enter values or expressions for:

- **Relative flow rate function**, Q_c
- **Fluid load on collar**, \mathbf{f}_c
- **Fluid load on bearing**, \mathbf{f}_b

User defined-general

The **User defined-general** option enables you to define arbitrary flow models. Both the Poiseuille and Couette terms in the mean velocity can be defined arbitrarily. It is also possible to define the expressions for the fluid forces on the collar and on the bearing, (these are included as feature inputs in other physics interfaces).

Enter values or expressions for:

- **Poiseuille mean fluid velocity coefficient**, $v_{\text{ave},P}$.
- **Couette mean fluid velocity component**, $\mathbf{v}_{\text{ave},C}$.

- **Fluid load on collar**, f_c .
- **Fluid load on bearing**, f_b .

Squeeze Film Damper

In the **Squeeze Film Damper** node, you specify the geometric dimensions, as well as journal and lubricant properties necessary to model a squeeze film damper.

DAMPER PROPERTIES

Enter the value of the **Clearance**, C .

JOURNAL PROPERTIES

Enter the value of the **Journal displacement** vector.



The **Journal displacement** list normally only contains **User defined**. When combined with another physics interface that can provide this type of displacement, it is also possible to choose a predefined displacement from this list.

Select **Velocity of the journal** — **Whirl speed** or **Velocity field**. In the **Whirl speed** case, select **User defined**, and enter the whirl speed value. This speed is the angular speed for the circular orbital motion of the journal.



The **Whirl speed** list normally only contains **User defined**. When combined with another physics interface that can provide this type of data, it is also possible to choose a predefined angular speed from this list.

When the journal motion is not circular, velocity of the journal can be defined as a velocity field. In the **Velocity field** case, select **User defined**, and enter the velocity field of the journal.



The **Velocity field** list normally only contains **User defined**. When combined with another physics interface that can provide this type of data, it is also possible to choose a predefined velocity field from this list.

FILM BOUNDARY CONDITION

This section is only available for some of the **Physical Model** settings in the **Hydrodynamic Bearing** interface:

- **Equation type** is **Reynolds equation** and **Cavitation** is not selected in the **Cavitation** section.
- **Equation type** is **Modified Reynolds equation**

Select the **Film type** — **Sommerfeld** or **Gümbel**. In the Sommerfeld case, a complete 2π film is considered in the net force calculation in the bearing. In the Gümbel case, only half of the film where the pressure is positive (π film) is used for computing the net force in the bearing.

CENTERING SPRING

Squeeze film dampers themselves are not capable of supporting any static load. Centering springs are provided in the dampers to support the static load. Enter the values of **Spring constant**, k_{cs} , and **Damping constant**, c_{cs} , of the centering spring.

FLUID PROPERTIES

The default **Dynamic viscosity**, μ , is taken **From material**. For **User defined**, enter a different value or expression.

With the default options, the **Density**, ρ , is taken **From material**. For **User defined** enter a different value or expression. If the **Modified Reynolds Equation** is being solved, the density is determined automatically by the ideal gas law. If cavitation is enabled, the density is assumed to take the form $\rho = \rho_c \exp(\beta p_f)$, where p_f is the fluid pressure, ρ_c is the density at the cavitation pressure, and β is the compressibility. In this case, enter the values for the **Density at cavitation pressure**, ρ_c , and the **Compressibility**, β .

FILM FLOW MODEL

Select **Film flow model** — **No-slip walls** or **Slip at walls**. In the **Slip at walls** case, enter the values of **Slip length, journal**, L_{sj} , and **Slip length, bearing**, L_{sb} .

Bearing Orientation

In the **Bearing Orientation** node, you specify the orientation of the bearing with respect to spatial directions.

BEARING ORIENTATION

Select an **Axis** — **x-Axis**, **y-Axis**, **z-Axis**, or **User defined** — to specify the axis of the bearing. Except for the **User defined** case, the axis passes through the origin. In the **User defined** case, also select **Center** — **Automatic** or **User defined**.

- **Automatic:** The centroid of the bearing surface is the base point the bearing axis.
- **User defined:** Enter the coordinates of the **Base point on bearing axis**.

Enter the **Bearing orientation vector defining local y direction**. The direction given will be adjusted so that it is orthogonal to the rotor axis. The default value is the global *y*-axis.

You can further modify the *y*-axis orientation by entering an angle for the **Rotation of orientation vector around bearing axis**. The direction inferred from the previous setting will be rotated counterclockwise around the rotor axis.



This is required input data.

Border

Use the **Border** node to set a pressure condition at the border and the border flow type.

The **Border flow** condition is used to account for the pressure drop caused by the flow converging into the gap, outside the thin layer. The acoustic elongation option does this by adding additional thickness to the thin layer beyond the edge of the geometry (assuming a pressure gradient in this layer equal to that at the boundary). The out-of-plane motion calculates the pressure gradient due to circulation of the fluid caused by motion of the journal or bearing surfaces using a predefined model. Alternatively, the pressure gradient at the boundary can be specified using an arbitrary expression, which allows for more sophisticated, user-defined models.

BORDER SETTINGS

Select a **Border condition** — **Zero pressure**, **Pressure**, or **Border flow**.

When the **Cavitation** check box is selected for the physics interface, **Starvation** is also available.

For **Pressure**, enter a **Pressure** p_{f0} to define $p_f = p_{f0}$ on the edge. If the reference pressure p_{ref} , defined at the physics interface level, is 0, p_{f0} is the absolute pressure. Otherwise, p_{f0} is the relative pressure.

For **Border flow**, select a **Border flow type** — **Acoustic boundary condition-absolute elongation**, **Acoustic boundary condition-relative elongation**, **Out-of-plane motion**, or **User defined**.

- For **Acoustic Boundary condition-absolute elongation**, enter a **Border elongation** ΔL .
- For **Acoustic boundary condition-relative elongation**, enter a **Relative border elongation** ΔL_r .
- For **Out-of-plane motion**, enter the **Model coefficients** η , ζ , and χ with defaults 0, 0, and 1, respectively. Also enter the **Slip length**, L . The default slip length uses an if condition to set the slip length equal to that defined in the **Hydrodynamic Journal Bearing** node if a suitable **Film flow model** is selected. If the Slip length is not defined in the [Hydrodynamic Journal Bearing](#) node, it defaults to 0.1 μm .

Note that the coefficients can be specified according to the results given in the paper by Gallis and Torczynski (M. A. Gallis and J. R. Torczynski, “An Improved Reynolds-Equation Model for Gas Damping of Microbeam Motion”, *Journal of Microelectromechanical Systems*, vol. 13, pp. 653–659, 2004). The following values are recommended:

$$\chi = \frac{1 + 8.834\left(\frac{\Lambda}{h}\right)}{1 + 5.118\left(\frac{\Lambda}{h}\right)}$$

$$\eta = \frac{0.634 + 1.572\left(\frac{\Lambda}{h}\right)}{1 + 0.537\left(\frac{\Lambda}{h}\right)}$$

$$\zeta = \frac{0.445 + 11.20\left(\frac{\Lambda}{h}\right)}{1 + 5.510\left(\frac{\Lambda}{h}\right)}$$

where h is the gap height. The above equations are valid in the range $0 \leq \Lambda/h \leq 1$.

- For **User defined** enter a **Normal pressure gradient**. For **Starvation** enter a value for the **Fluid fraction** θ_0 .

Initial Values

The **Initial Values** node adds an initial value for the pressure that can serve as an initial condition for a transient simulation or as an initial guess for a nonlinear solver. If more than one set of initial values is required, add additional **Initial Values** nodes from the **Physics** toolbar.

INITIAL VALUES

Enter a value or an expression for the initial value of the **Pressure** p_f .

Inlet

Use the **Inlet** node to define an edge or a part of the boundary where fluid enters the gap.

INLET SETTINGS

For the **Inlet** node with edge selection, select an **Inlet condition** — **Zero pressure**, **Pressure**, or **Normal inflow velocity**.

When the **Cavitation** check box is selected for the physics interface (see [Cavitation](#)), **Starvation** is also available.

- For **Zero pressure**, $p_f = 0$ applies on the edge.
- For **Pressure**, enter a **Pressure** p_{f0} to impose $p_f = p_{f0}$ on the edge. If the reference pressure p_{ref} , defined at the physics interface level, is 0, p_{f0} is the absolute pressure. Otherwise, p_{f0} is the relative pressure.
- For **Normal inflow velocity**, enter a **Normal inflow velocity** U_0 .
- For **Starvation**, enter a value for the **Fluid fraction** θ_0 .

For the **Inlet** node with boundary selection, specify the **Pressure** at the inlet.

Outlet

The **Outlet** node defines an edge or a part of boundary where fluid leaves the gap.

OUTLET SETTINGS

For the **Outlet** node with edge selection, select an **Outlet condition** — **Zero pressure**, **Pressure**, or **Normal outflow velocity**.

- When the **Cavitation** check box is selected for the physics interface (see [Cavitation](#)), **Starvation** is also available. For **Zero pressure** $p_f = 0$ applies on the edge.
- For **Pressure**, enter a **Pressure** p_{f0} to impose $p_f = p_{f0}$ on the edge. If the reference pressure p_{ref} , defined at the physics interface level, is 0, p_{f0} is the absolute pressure. Otherwise, p_{f0} is the relative pressure.
- For **Normal outflow velocity**, enter a **Normal outflow velocity** U_0 .
- For **Starvation**, enter a value for the **Fluid fraction** θ_0 .

For the **Outlet** node with boundary selection, **Outlet condition** is set to **Pressure** by default. Enter a **Pressure** p_{f0} to impose $p_f = p_{f0}$ on the boundary.

When the **Cavitation** check box is selected for the physics interface (see [Cavitation](#)), **Starvation** is also available. For **Starvation**, enter a value for the **Fluid fraction** θ_0 .

Wall

The **Wall** node prevents fluid flow in the direction perpendicular to the boundary.

Symmetry

The **Symmetry** node sets the perpendicular component of the average velocity in the gap to zero.

Multiphysics Interfaces and Couplings

The Rotordynamics Module contains predefined multiphysics interfaces to facilitate easy setup of couplings between journals and bearings. The physics interfaces are found under the **Rotordynamics** branch () when adding a physics interface — **Solid Rotor with Hydrodynamic Bearing** and **Beam Rotor with Hydrodynamic Bearing**.

In this chapter:

- [The Solid Rotor with Hydrodynamic Bearing Interface](#)
- [The Beam Rotor with Hydrodynamic Bearing Interface](#)
- [Solid-Bearing Coupling](#)
- [Theory for the Solid Rotor Bearing Coupling](#)
- [Theory for the Beam Rotor Bearing Coupling](#)
- [Theory for Solid-Bearing Coupling](#)

The Solid Rotor with Hydrodynamic Bearing Interface

The **Solid Rotor with Hydrodynamic Bearing** interface () combines a Solid Rotor interface with a Hydrodynamic Bearing interface. The coupling occurs on the boundary level, where the displacement and velocity from the Solid Rotor interface governs the fluid-film thickness in the Hydrodynamic Bearing interface, and the pressure distribution on the journal surface from the Hydrodynamic Bearing interface acts as an external load on the Solid Rotor interface.

When a predefined **Solid Rotor with Hydrodynamic Bearing** interface is added from the **Structural Mechanics>Rotordynamics** branch () of the **Model Wizard** or **Add Physics** windows, **Solid Rotor** and **Hydrodynamic Bearing** interfaces are added to the Model Builder.

In addition, the **Multiphysics** node is added, which automatically includes the multiphysics coupling feature **Solid Rotor Bearing Coupling**.

On the Constituent Physics Interfaces

The Solid Rotor interface is intended for general rotordynamics analysis of rotors modeled using 3D geometries. The Solid Rotor interface is based on solving Navier's equations. The interface also includes the effect of the frame acceleration due to rotation and computes results such as displacements, stresses, and strains.

The Hydrodynamic Bearing interface provides features for modeling the flow in thin fluid films such as Journal Bearings. A Hydrodynamic Journal Bearing model is active by default on all boundaries. You should select only those boundaries that correspond to the bearing. The pressure equation used in the fluid film is the Reynolds equation.

SETTINGS FOR PHYSICS INTERFACES AND COUPLING FEATURES

When physics interfaces are added using the predefined couplings, specific settings are included with the physics interfaces and the coupling features.

However, if physics interfaces are added one at a time, followed by the coupling features, these modified settings are not automatically included.

For example, if single **Solid Rotor** and **Hydrodynamic Bearing** interfaces are added, an empty **Multiphysics** node appears in the model tree. You can choose from the available coupling features, but the settings in the constituent interfaces are not modified.



Coupling features are available from the context menu (right-click the **Multiphysics** node) or from the **Physics** toolbar, **Multiphysics** menu.

PHYSICS INTERFACES AND COUPLING FEATURES

Coupling Features

The **Solid Rotor Bearing Coupling** node is described in this section.

Solid Rotor Bearing Coupling

The **Solid Rotor Bearing Coupling** () transfers the velocity and displacement information from the Solid Rotor interface to the Hydrodynamic Bearing interface and at the same time applies the pressure on the fluid film from the Hydrodynamic Bearing interface as an external load in Solid Rotor interface.

SETTINGS

The **Label** is the default multiphysics coupling feature name.

The **Name** is used primarily as a scope prefix for variables defined by the coupling node. Refer to such variables in expressions using the pattern <name>.<variable_name>. In order to distinguish between variables belonging to different coupling nodes or physics interfaces, the name string must be unique. Only letters, numbers, and underscores (_) are permitted in the **Name** field. The first character must be a letter.

The default **Name** (for the first multiphysics coupling feature in the model) is **srbc**.

BOUNDARY SELECTION

When nodes are added from the context menu, common boundaries between the Solid Rotor and Hydrodynamic Bearing interfaces are selected by default. You can optionally remove any unwanted boundaries from the selection.

COUPLED INTERFACES

This section defines the physics involved in the multiphysics coupling. The **Rotor** and **Bearing** lists include all applicable physics interfaces.

The default values depend on how the coupling node is created.

- If it is added from the **Physics** ribbon (Windows users), **Physics** contextual toolbar (Mac and Linux users), or context menu (all users), then the first physics interface of each type in the component is selected as the default.
- If it is added automatically when a multiphysics interface is selected in the **Model Wizard** or **Add Physics** window, then the two participating physics interfaces are selected.

You can also select **None** from either list to uncouple the Solid Rotor Bearing Coupling node from a physics interface. If one of the participating physics interfaces is removed from the **Model Builder**, the corresponding entry is set to **None** as there is nothing to couple to.



If a physics interface is deleted and then added to the model again, then in order to reestablish the coupling, you need to choose the physics interface again from the **Rotor** or **Bearing** lists. This is applicable to all multiphysics coupling nodes that would normally default to the once-present interface. See [Multiphysics Modeling Workflow](#) in the *COMSOL Multiphysics Reference Manual*.

The Beam Rotor with Hydrodynamic Bearing Interface

The **Beam Rotor with Hydrodynamic Bearing** () interface combines a Beam Rotor interface with a Hydrodynamic Bearing interface. The coupling occurs on the boundary level on the Hydrodynamic Bearing selection. The displacement and velocity from the Beam Rotor interface are mapped to the bearing surface, thus governing the fluid-film thickness in the Hydrodynamic Bearing interface. The pressure distribution on the journal surface from the Hydrodynamic Bearing interface acts as an external load in the Beam Rotor interface.

When a predefined **Beam Rotor with Hydrodynamic Bearing** interface is added from the **Structural Mechanics>Rotordynamics** branch () of the **Model Wizard** or **Add Physics** windows, **Beam Rotor** and **Hydrodynamic Bearing** interfaces are added to the Model Builder.

In addition, the **Multiphysics** node is added, which automatically includes the multiphysics coupling feature **Beam Rotor Bearing Coupling**.

On the Constituent Physics Interfaces

The Beam Rotor interface is intended for general rotordynamics analysis of rotors modeled using line geometries. The Beam Rotor interface is based on the Timoshenko beam theory. The interface also includes the effect of the frame acceleration due to rotation and computes results such as displacements, stresses, and strains.

The Hydrodynamic Bearing interface provides features for modeling the flow in thin fluid-films such as journal bearings. A Hydrodynamic Journal Bearing model is active by default on all boundaries. You should select only those boundaries that correspond to the bearing. The pressure equation defined on the fluid film is the Reynolds equation.

SETTINGS FOR PHYSICS INTERFACES AND COUPLING FEATURES

When physics interfaces are added using the predefined couplings, specific settings are included with the physics interfaces and coupling features.

However, if physics interfaces are added one at a time, followed by the coupling features, these modified settings are not automatically included.

For example, if single **Beam Rotor** and **Hydrodynamic Bearing** interfaces are added, an empty **Multiphysics** node appears in the model tree. You can choose from the available coupling features but the settings in the constituent interfaces are not modified.



Coupling features are available from the context menu (right-click the **Multiphysics** node) or from the **Physics** toolbar, **Multiphysics** menu.

PHYSICS INTERFACES AND COUPLING FEATURES

Coupling Features

The **Beam Rotor Bearing Coupling** feature node is described in this section.

Beam Rotor Bearing Coupling

The **Beam Rotor Bearing Coupling** () transfers the velocity and displacement information of the journal from the Beam Rotor interface to the Hydrodynamic Bearing interface and at the same time applies the pressure on the fluid film from the Hydrodynamic Bearing interface as a external load in the Beam Rotor interface.

SETTINGS

The **Label** is the default multiphysics coupling feature name.

The **Name** is used primarily as a scope prefix for variables defined by the coupling node. Refer to such variables in expressions using the pattern <name>.<variable_name>. In order to distinguish between variables belonging to different coupling nodes or physics interfaces, the **name** string must be unique. Only letters, numbers, and underscores (_) are permitted in the **Name** field. The first character must be a letter.

The default **Name** (for the first multiphysics coupling feature in the model) is **brbc**.

BOUNDARY SELECTION

When nodes are added from the context menu, all the boundaries selected in the Hydrodynamic Bearing interfaces are selected by default. You can optionally remove the unwanted boundaries from the selection.

COUPLED INTERFACES

This section defines the physics involved in the multiphysics coupling. The **Rotor** and **Bearing** lists include all applicable physics interfaces.

The default values depend on how the coupling node is created.

- If the node is added from the **Physics** ribbon (Windows users), **Physics** contextual toolbar (Mac and Linux users), or context menu (all users), then the first physics interface of each type in the component is selected as the default.
- If it the node added automatically when a multiphysics interface is selected in the **Model Wizard** or **Add Physics** window, then the two participating physics interfaces are selected.

You can also select **None** from either list to uncouple the Beam Rotor Bearing Coupling node from a physics interface. If one of the participating physics interfaces is removed from the **Model Builder**, the corresponding entry is set to **None** as there is nothing to couple to.



If a physics interface is deleted and then added to the model again, then in order to reestablish the coupling, you need to choose the physics interface again from the **Rotor** or **Bearing** lists. This is applicable to all multiphysics coupling nodes that would normally default to the once-present interface. See [Multiphysics Modeling Workflow](#) in the *COMSOL Multiphysics Reference Manual*.

Solid-Bearing Coupling

The **Solid-Bearing Coupling** () transfers the velocity and displacement information from the Solid Mechanics or Multibody Dynamics interfaces to the Hydrodynamic Bearing interface and at the same time applies the pressure on the fluid film from the Hydrodynamic Bearing interface as an external load in a Solid Mechanics or Multibody Dynamics interface.

SETTINGS

The **Label** is the default multiphysics coupling feature name.

The **Name** is used primarily as a scope prefix for variables defined by the coupling node. Refer to such variables in expressions using the pattern `<name>.<variable_name>`. In order to distinguish between variables belonging to different coupling nodes or physics interfaces, the name string must be unique. Only letters, numbers, and underscores (`_`) are permitted in the **Name** field. The first character must be a letter.

The default **Name** (for the first multiphysics coupling feature in the model) is `sbco`.

BOUNDARY SELECTION

When nodes are added from the context menu, common boundaries between the Solid Mechanics or Multibody Dynamics interface and the Hydrodynamic Bearing interface are selected by default. You can optionally remove any unwanted boundaries from the selection.

FOUNDATION

Select the **Include foundation** check box to include the effect of the foundation motion. If selected, a selection input **Foundation Selection** appears. Boundaries not common to **Bearing** and **Solid** can be selected in the **Foundation Selection**.

COUPLED INTERFACES

This section defines the physics involved in the multiphysics coupling. The **Solid** and **Bearing** lists include all applicable physics interfaces.

The first physics interface of each type in the component is selected as the default. You can also select **None** from either list to uncouple the **Solid-Bearing Coupling** node from a physics interface. If one of the participating physics interfaces is removed from the **Model Builder**, the corresponding entry is set to **None** as there is nothing to couple to.



If a physics interface is deleted and then added to the model again, then in order to reestablish the coupling, you need to choose the physics interface again from the **Solid** or **Bearing** lists. This is applicable to all multiphysics coupling nodes that would normally default to the once-present interface. See [Multiphysics Modeling Workflow](#) in the *COMSOL Multiphysics Reference Manual*.



See also [Theory for the Solid Rotor Bearing Coupling](#).

Theory for the Solid Rotor Bearing Coupling

The fluid pressure in the bearing depends on the thickness of the lubricant, which strongly depends on the motion of the journal in the bearing. The thickness of the fluid film can be obtained by calculating the gap between the journal and bearing surfaces. In the Hydrodynamic Bearing interface, the initial journal surface is considered as the reference surface for the analysis. Therefore, the height of the journal surface from the reference surface deformation can be determined by considering a material point $\mathbf{X}_{r,j}$ on the journal surface in the direction $\mathbf{e}_{r,r}(x_1, \Theta)$ from the center of the bearing in the corotating frame:

$$\mathbf{X}_{r,j} = \mathbf{X}_C + R_j \mathbf{e}_{r,r}(x_1, \Theta)$$

In general, \mathbf{X}_C is a function of the axial coordinate x_1 and R_j can be a function of both Θ and x_1 . After deformation, the current position of this point in the corotating frame is

$$\mathbf{x}_{r,j} = \mathbf{X}_{r,j} + \mathbf{u}_r(\mathbf{X}_{r,j})$$

Note that the current position is no longer aligned with the radial direction $\mathbf{e}_{r,r}(x_1, \Theta)$. The position of the point on the journal surface that is aligned with the radial direction $\mathbf{e}_{r,r}(x_1, \Theta)$ can be approximated by

$$\mathbf{x}'_{r,j} = \mathbf{x}_{r,j} - (\nabla_t \mathbf{x}_{r,j} \cdot \mathbf{u}_r)$$

The coordinates of this point in the spatial frame are:

$$\mathbf{x}_j = \mathbf{X}_C + R(\mathbf{x}'_{r,j} - \mathbf{X}_C)$$

Similarly, the coordinates of the material point $\mathbf{X}_{r,j}$ without the deformation, in the spatial frame are:

$$\mathbf{X}_j = \mathbf{X}_C + R(\mathbf{X}_{r,j} - \mathbf{X}_C)$$

Then, the height of the journal surface from the reference surface in the radial direction $\mathbf{e}_r(x_1, \Theta)$ in the spatial frame, corresponding to the radial direction $\mathbf{e}_{r,r}(x_1, \Theta)$ in a corotating frame, is

$$h_j = (\mathbf{x}_j - \mathbf{X}_j) \cdot \mathbf{e}_r = (\mathbf{x}'_{r,j} - \mathbf{X}_{r,j}) \cdot \mathbf{e}_{r,r} = (\mathbf{u}_r - (\nabla_t \mathbf{x}_{r,j} \cdot \mathbf{u}_r)) \cdot \mathbf{e}_{r,r}$$

If the reference surface is a cylindrical surface, then R_j is independent of both Θ and x_1 , and $\mathbf{e}_{r,r}$ is only a function of Θ . Then

$$\begin{aligned} \nabla_t \mathbf{x}_{r,j} &= \frac{1}{R_j} \frac{\partial \mathbf{x}_{r,j}}{\partial \Theta} \otimes \mathbf{e}_{r,\Theta} + \frac{\partial \mathbf{x}_{r,j}}{\partial x_1} \otimes \mathbf{e}_{r,1} = \\ \mathbf{e}_{r,\Theta} \otimes \mathbf{e}_{r,\Theta} + \frac{1}{R_j} \frac{\partial \mathbf{u}_r}{\partial \Theta} \otimes \mathbf{e}_{r,\Theta} + \frac{\partial \mathbf{u}_r}{\partial x_1} \otimes \mathbf{e}_{r,1} &= \mathbf{e}_{r,\Theta} \otimes \mathbf{e}_{r,\Theta} + \nabla_t \mathbf{u}_r \end{aligned}$$

Therefore, the height of the journal surface from the reference surface in the radial direction neglecting the higher-order terms in displacement is

$$h_j = \mathbf{u}_r(\mathbf{X}_{r,j}) \cdot \mathbf{e}_{r,r} = R \mathbf{u}_r(\mathbf{X}_{r,j}) \cdot \mathbf{e}_r$$

Now, to determine the height of the bearing surface from the reference surface, consider a radially aligned material point \mathbf{X}_b on the bearing corresponding to the point \mathbf{X}_j in the spatial frame. Then

$$\mathbf{X}_b = \mathbf{X}_j + C(x_1, \Theta) \mathbf{e}_r$$

C is the initial clearance between the journal and bearing. After the deformation, the current position of this point in the spatial frame is

$$\mathbf{x}_b = \mathbf{X}_b + \mathbf{u}(\mathbf{X}_b)$$

Note that the current position is no longer aligned with the radial direction \mathbf{e}_r . The position of the point on the bearing surface that is aligned with the radial direction \mathbf{e}_r can be approximated as

$$\mathbf{x}'_B = \mathbf{x}_b - (\nabla_t \mathbf{x}_b \cdot \mathbf{u})$$

Then, the height of the bearing surface from the reference surface in the radial direction \mathbf{e}_r in the spatial frame is:

$$h_b = (\mathbf{x}'_b - \mathbf{X}_b) \cdot \mathbf{e}_r = (C \mathbf{e}_r + \mathbf{u} - \nabla_t \mathbf{x}_b \cdot \mathbf{u}) \cdot \mathbf{e}_r$$

For a cylindrical reference surface, R_j is independent of both Θ and x_1 , and \mathbf{e}_r is only a function of Θ . Then

$$\begin{aligned}\nabla_t \mathbf{x}_b &= \frac{1}{R_j} \frac{\partial \mathbf{x}_b}{\partial \Theta} \otimes \mathbf{e}_\Theta + \frac{\partial \mathbf{x}_b}{\partial x_1} \otimes \mathbf{e}_1 = \\ &\mathbf{e}_r \otimes \nabla_t C + \frac{C}{R_j} \mathbf{e}_\Theta \otimes \mathbf{e}_\Theta + \nabla_t \mathbf{u}_r\end{aligned}$$

Therefore, the height of the bearing surface from the reference surface in the radial direction, neglecting the higher-order terms in displacement, is:

$$h_b = C + \mathbf{u} \cdot \mathbf{e}_r + \mathbf{u} \cdot \nabla_t C$$

The fluid-film thickness between the journal and the bearing is thus given by:

$$h = h_b - h_j = C + \{\mathbf{u}_b(\mathbf{X}_b) - R \mathbf{u}_{r,j}(\mathbf{X}_{r,j})\} \cdot \mathbf{e}_r + \mathbf{u}_b(\mathbf{X}_b) \cdot \nabla_t C$$

If a point \mathbf{X} on the reference surface corresponds to the point \mathbf{X}_j on the journal surface and \mathbf{X}_b on the bearing surface, then

$$\begin{aligned}\mathbf{u}_b(\mathbf{X}_b) &= \mathbf{u}_b(\mathbf{X}) \\ \mathbf{u}_{r,j}(\mathbf{X}_{r,j}) &= \mathbf{u}_{r,j}(\mathbf{X}_C + R^T (\mathbf{X} - \mathbf{X}_C))\end{aligned}$$

The spatial component of the velocity of the journal at the point \mathbf{X} on the reference surface is given by

$$\begin{aligned}\mathbf{v}_j &= \frac{\partial \mathbf{x}_j}{\partial t} = \frac{\partial R}{\partial t} (\mathbf{X}_{r,j} + \mathbf{u}_{r,j}(\mathbf{X}_{r,j}) - \mathbf{X}_C) + R \frac{\partial \mathbf{u}_{r,j}}{\partial t} = \\ &\Omega \times (\mathbf{x}_j - \mathbf{X}_C) + R \frac{\partial \mathbf{u}_{r,j}}{\partial t}\end{aligned}$$

Similarly, the spatial component of the velocity of the bearing at the point \mathbf{X} on the reference surface is given by

$$\mathbf{v}_b = \frac{\partial \mathbf{u}_b}{\partial t}$$

Therefore, from the Solid Rotor interface, the variables $\mathbf{u}_{r,j}$ and Ω are supplied to the Hydrodynamic Bearing interface to compute the film thickness and average velocity of the fluid, which is then used for determining the distribution of the fluid pressure in the bearing. Distributed forces per unit area \mathbf{f}_{jA} on the journal and \mathbf{f}_{bA} on the bearing as a function of the point \mathbf{X} on the reference surface can be calculated using the

pressure distribution in the bearing. This is implemented in the weak form by writing the contribution to the virtual work due to the pressure loads. The contribution to the virtual work on the journal due to the force applied by the fluid film is:

$$\begin{aligned}\delta W_j &= \int_A \{\mathbf{f}_{jA}(\mathbf{X}) \cdot \delta \mathbf{x}_j\} dA = \int_A \{\mathbf{f}_{jA}(\mathbf{X}) \cdot R \delta \mathbf{u}_{r,j}(\mathbf{X}_{r,j})\} dA = \\ &\int_A \{R^T \mathbf{f}_{jA}(\mathbf{X}_C + R(\mathbf{X}_{r,j} - \mathbf{X}_C)) \cdot \delta \mathbf{u}_{r,j}(\mathbf{X}_{r,j})\} dA\end{aligned}$$

and the contribution to the virtual work on the bearing is

$$\delta W_b = \int_A \{\mathbf{f}_{bA}(\mathbf{X}) \cdot \delta \mathbf{u}_b(\mathbf{X})\} dA$$

Note the use of body-fixed coordinates in the rotating frame in the virtual work expression on the journal.

Theory for the Beam Rotor Bearing Coupling

The fluid pressure in the bearing depends on the thickness of the lubricant, which strongly depends on the motion of the journal in the bearing. The thickness of the fluid film can be obtained by calculating the gap between the journal and bearing surfaces. In the Hydrodynamic Bearing interface, the initial journal surface is considered as the reference surface for the analysis. In the Beam Rotor interface, all the degrees of freedom are defined to have components in the spatial frame. Therefore, the current position of the point on the journal surface corresponding to a point \mathbf{X} on the reference surface is given as:

$$\mathbf{x}_j = \mathbf{X} + \mathbf{u}_{bm} + \theta_{bm} \times (\mathbf{X} - \mathbf{X}_{bm}) = \mathbf{X} + \mathbf{u}_j$$

where \mathbf{X}_{bm} , \mathbf{u}_{bm} , and θ_{bm} are the position, displacement, and rotation of a point on the beam rotor nearest to the point \mathbf{X} on the reference surface. The height of the journal surface from the reference surface is the normal component of the relative position of the point on the journal surface relative to the point \mathbf{X} on the reference surface, and is given by

$$h_j = \mathbf{u}_j \cdot \mathbf{n}_{ref}$$

Similarly, the current position on a point on the bearing surface corresponding to a point \mathbf{X} on the reference surface is

$$\mathbf{x}_b = \mathbf{X}_b + \mathbf{u}_b = \mathbf{X} + h_{b1} \mathbf{n}_{ref} + \mathbf{u}_b$$

Here, h_{b1} is the initial height of the bearing with respect to the reference surface and is called initial clearance. However, this point on the bearing surface is not aligned with the original reference normal \mathbf{n}_{ref} . The position of the point that is aligned with the original reference normal can be obtained approximately by the following:

$$\begin{aligned} \mathbf{x}_b' &= \mathbf{x}_b - (\nabla_t \mathbf{x}_b \cdot \mathbf{u}_b) = \\ &= \mathbf{X} + h_{b1} \mathbf{n}_{ref} + \mathbf{u}_b - (\nabla_t \mathbf{X} + \mathbf{n}_{ref} \otimes \nabla_t h_{b1} + h_{b1} \nabla_t \mathbf{n}_{ref}) \cdot \mathbf{u}_b \end{aligned}$$

Then the height of the bearing surface with respect to reference surface along the reference normal \mathbf{n}_{ref} is given by

$$h_b = (\mathbf{x}_b' - \mathbf{X}) \cdot \mathbf{n}_{\text{ref}} = h_{b1} + \mathbf{u}_b \cdot \mathbf{n}_{\text{ref}} - (\nabla_t h_{b1} \cdot \mathbf{u}_b)$$

Here, the fact that the tangential gradients of \mathbf{X} and \mathbf{n}_{ref} are in the plane of the reference surface and hence are perpendicular to \mathbf{n}_{ref} has been used.

Therefore, the film thickness in the reference normal direction is given by the difference of the height of the bearing surface and the height of the journal surface from the reference surface:

$$h = h_b - h_j = h_{b1} + (\mathbf{u}_b - \mathbf{u}_j) \cdot \mathbf{n}_{\text{ref}} - (\nabla_t h_{b1} \cdot \mathbf{u}_b)$$

The spatial component of the velocity of the journal at the point \mathbf{X} on the reference surface has a component due to journal rotation and is given by

$$\mathbf{v}_j = \frac{\partial \mathbf{x}_j}{\partial t} + \Omega \times (\mathbf{X} - \mathbf{X}_c) = \frac{\partial \mathbf{u}_j}{\partial t} + \Omega \times (\mathbf{X} - \mathbf{X}_c)$$

Similarly, the spatial component of the velocity of the bearing at the point \mathbf{X} on the reference surface is given by

$$\mathbf{v}_b = \frac{\partial \mathbf{u}_b}{\partial t}$$

Therefore, from the Beam Rotor interface, the variables \mathbf{u}_j and Ω are supplied to the Hydrodynamic Bearing interface to compute the film thickness and average velocity of the fluid, which are then used for determining the distribution of the fluid pressure in the bearing. The distributed force per unit area \mathbf{f}_{jA} on the journal and \mathbf{f}_{bA} on the bearing as a function of the point \mathbf{X} on the reference surface can be calculated using the pressure distribution in the bearing. This is implemented in the weak form by writing the contribution to the virtual work from these loads. The contribution to the virtual work on the journal due to the force applied by the fluid film is

$$\delta W_j = \int_A \mathbf{f}_{jA}(\mathbf{X}) \cdot \delta \mathbf{u}_j dA$$

and the contribution to the virtual work on the bearing is

$$\delta W_B = \int_A \mathbf{f}_{bA}(\mathbf{X}) \cdot \delta \mathbf{u}_b(\mathbf{X}) dA$$

Theory for Solid-Bearing Coupling

Coupling of any structural component with the Hydrodynamic Bearing interface requires a correct evaluation of the change in film thickness due to the relative motion of the solid component and bearing surfaces. This relative motion can be split into two components: sliding and squeezing. Sliding motion does not change the film thickness, provided that there is a natural geometrically wedge in which the lubricant is trapped. Squeezing motion, however, directly affects the film thickness. Therefore, the motion of the structural components has to be split into these two components to evaluate the change in the film thickness.

Consider the structure and bearing arrangement shown in [Figure 7-1](#)

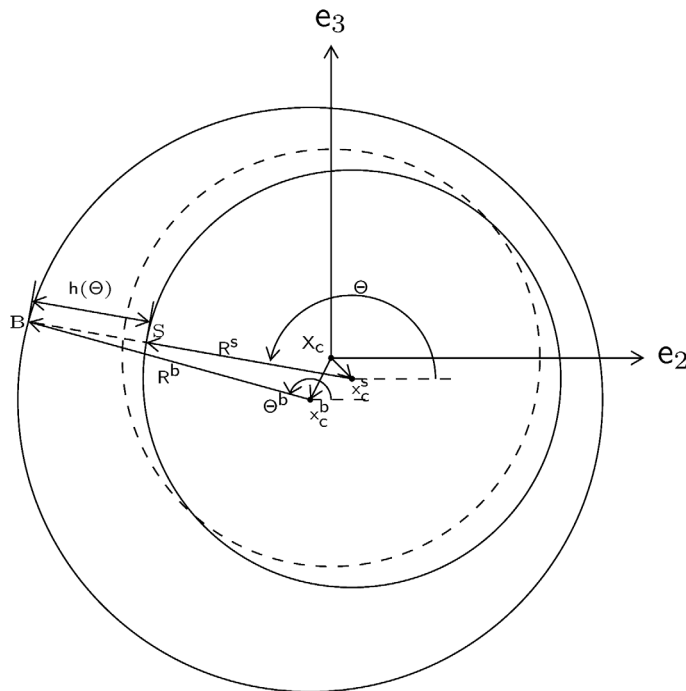

Figure 7-1: Structure moving in bearing. The initial position of the structure is dashed.

Initially, both structure and bearing are concentric to each other with the common center located at \mathbf{X}_c . During operation they move relative to each other. Let the centers of the structure and bearing now be located at \mathbf{x}_c^s and \mathbf{x}_c^b , respectively. The film

thickness is obtained by calculating the height of the bearing surfaces from the structure surface. To evaluate the film thickness, consider a radial line from the current center of the structure \mathbf{x}_c^s at an angle Θ from the local y -axis. This line intersects the bearing and the structural surfaces at points B and S, respectively. The radial line from the new center of the bearing \mathbf{x}_c^b to B makes an angle Θ^b from the local y -axis. Let the normalized radial vectors from structure and bearing surfaces be $\mathbf{e}_r(\Theta)$ and $\mathbf{e}_r(\Theta^b)$, respectively. The position vector of the point B is given by

$$\mathbf{x}^b = \mathbf{x}_c^b + R^b(\Theta^b)\mathbf{e}_r(\Theta^b)$$

Similarly, the position vector of the point S is given by

$$\mathbf{x}^s = \mathbf{x}_c^s + R^s(\Theta)\mathbf{e}_r(\Theta)$$

Here \mathbf{x}^b and \mathbf{x}^s are the position vectors of the points B and S, respectively. $R^b(\Theta^b)$ and $R^s(\Theta)$ are the radial positions of the bearing and structure surfaces from their respective centers. Since the points B and S are located along the radial vector $\mathbf{e}_r(\Theta)$:

$$\begin{aligned} h(\Theta) &= (\mathbf{x}^b - \mathbf{x}^s) \cdot \mathbf{e}_r(\Theta) \\ 0 &= (\mathbf{x}^b - \mathbf{x}^s) \cdot \mathbf{e}_\theta(\Theta) \end{aligned}$$

In the local bearing coordinate system:

$$\begin{aligned} \mathbf{e}_r(\Theta) &= (\cos\Theta)\mathbf{e}_2 + (\sin\Theta)\mathbf{e}_3 \\ \mathbf{e}_r(\Theta^b) &= (\cos\Theta^b)\mathbf{e}_2 + (\sin\Theta^b)\mathbf{e}_3 \\ \mathbf{e}_\theta(\Theta) &= \mathbf{e}_1 \times \mathbf{e}_r(\Theta) = -(\sin\Theta)\mathbf{e}_2 + (\cos\Theta)\mathbf{e}_3 \end{aligned} \tag{7-1}$$

Here, \mathbf{e}_1 is the bearing axis direction, and \mathbf{e}_2 and \mathbf{e}_3 are the two transverse directions.

Substituting the expressions for \mathbf{x}^b , \mathbf{x}^s , $\mathbf{e}_r(\Theta)$, $\mathbf{e}_r(\Theta^b)$, and $\mathbf{e}_\theta(\Theta)$ in Equation 7-1 and simplifying gives

$$\begin{aligned} h(\Theta) &= (\mathbf{x}_c^b - \mathbf{x}_c^s) \cdot \mathbf{e}_r(\Theta) + R^b(\Theta^b)\cos(\Theta^b - \Theta) - R^s(\Theta) \\ 0 &= (\mathbf{x}_c^b - \mathbf{x}_c^s) \cdot \mathbf{e}_\theta(\Theta) + R^b(\Theta^b)\sin(\Theta^b - \Theta) \end{aligned}$$

Since the centers of both the bearing and the structural surfaces were initially at the reference surface center, we have $\mathbf{x}_c^b = \mathbf{X}_c + \mathbf{u}_c^b$ and $\mathbf{x}_c^s = \mathbf{X}_c + \mathbf{u}_c^s$. Therefore,

$$\sin(\Theta^b - \Theta) = -\frac{(\mathbf{u}_c^b - \mathbf{u}_c^s) \cdot \mathbf{e}_\theta(\Theta)}{R^b(\Theta^b)} \quad (7-2)$$

and

$$h(\Theta) = (\mathbf{u}_c^b - \mathbf{u}_c^s) \cdot \mathbf{e}_r(\Theta) + R^b(\Theta^b) \left[1 - \left(\frac{(\mathbf{u}_c^b - \mathbf{u}_c^s) \cdot \mathbf{e}_\theta(\Theta)}{R^b(\Theta^b)} \right)^2 \right]^{1/2} - R^s(\Theta)$$

Given that

$$\frac{(\mathbf{u}_c^b - \mathbf{u}_c^s) \cdot \mathbf{e}_\theta(\Theta)}{R^b(\Theta^b)} \ll 1$$

the film thickness can be approximated as

$$h(\Theta) \approx (\mathbf{u}_c^b - \mathbf{u}_c^s) \cdot \mathbf{e}_r(\Theta) + R^b(\Theta^b) - R^s(\Theta)$$

This requires an evaluation of the radial position of the bearing with angular coordinate Θ^b . If the difference between Θ^b and Θ is assumed to be small, Equation 7-2 gives:

$$\Theta^b \approx \Theta - \frac{(\mathbf{u}_c^b - \mathbf{u}_c^s) \cdot \mathbf{e}_\theta(\Theta)}{R^b(\Theta^b)} = \Theta + \Delta\Theta$$

A Taylor series expansion gives:

$$R^b(\Theta^b) \approx R^b(\Theta) + \Delta\Theta \left. \frac{\partial R^b}{\partial \Theta} \right|_\Theta = R^b(\Theta) - (\mathbf{u}_c^b - \mathbf{u}_c^s) \cdot \mathbf{e}_\theta(\Theta) \frac{1}{R^b} \frac{\partial R^b}{\partial \Theta}$$

This can be generalized to include the change in R^b in the axial direction too in the following way:

$$R^b(\Theta^b, x_{ax}^b) \approx R^b(\Theta, x_{ax}) - (\mathbf{u}_c^b - \mathbf{u}_c^s) \cdot \nabla_t R^b$$

Substituting this in the film thickness expression:

$$h(\Theta) \approx (\mathbf{u}_c^b - \mathbf{u}_c^s) \cdot \mathbf{e}_r(\Theta) + R^b - R^s - (\mathbf{u}_c^b - \mathbf{u}_c^s) \cdot \nabla_t R^b$$

If the surface of the structure is flat or cylindrical, the tangential gradient of the radial position on the structure surface will be zero. Using $C = R^b - R^s$ the film thickness is

$$h(\Theta) \approx C + (\mathbf{u}_c^b - \mathbf{u}_c^s) \cdot (\mathbf{e}_r(\Theta) - \nabla_t C)$$

Effect of Deformation

The thickness expression obtained in the previous section only considered the motion at the center of the structure and bearing surfaces. In addition to this, both structure and bearing can tilt, bend and radially expand. Such motion will also affect the film thickness. Therefore, the film thickness in general is a function of the axial and azimuthal coordinates. The effect of the radial expansion can be accounted for by updating the initial clearance profile including the effect of radial deformation of both the structure and the bearing. However, such radial expansions are going to be small, except for the case of thermal expansion. Here, thickness changes due to radial expansion or contraction is neglected. Also, a rotation of the flat or cylindrical structural surface about the bearing axis will not change the film thickness and should be excluded while calculating the film thickness. These considerations require the motion of the both the structure and the bearing to be split into three components:

- Motion of the centerline of the structure
- Axial rotation
- Radial deformation

The film thickness calculation will only include the effect of the relative motion of the centerline of the structure and the bearing. The motion of the centerline is determined by splitting the total displacement into the following components:

- Displacement at the center: \mathbf{u}_c
- Axial rotation: θ
- Tilting about local y and z axes: α and β
- Bending deformation about local y and z axes: κ_y and κ_z

The total displacement can then be approximated in terms of these quantities as

$$\mathbf{u}_a = \mathbf{u}_c + (R - I)(\mathbf{X} - \mathbf{X}_c) + \mathbf{u}_b$$

The total rotation matrix is the combination of axial rotation followed by tilting rotation $R = R_{\alpha\beta}R_{\theta}$. Axial rotation can be finite but tilting rotations are small. The components of these matrices given in the local bearing direction are:

$$R_{\alpha\beta} = \begin{bmatrix} 1 & -\beta & \alpha \\ \beta & 1 & 0 \\ -\alpha & 0 & 1 \end{bmatrix}$$

and

$$R_{\theta} = \begin{bmatrix} 1 & 0 & 0 \\ 0 & \cos\theta & -\sin\theta \\ 0 & \sin\theta & \cos\theta \end{bmatrix}$$

Bending deformation is assumed to have a quadratic variation in local coordinates:

$$\mathbf{u}_b = \begin{bmatrix} \kappa_z(r_2)^2 - \kappa_y(r_3)^2 \\ -\kappa_z(r_1)^2 \\ \kappa_y(r_1)^2 \end{bmatrix}$$

with

$$r_i = (\mathbf{X} - \mathbf{X}_c) \cdot \mathbf{e}_i$$

Parameters in the approximated expressions are obtained by minimizing the least-squares error between the approximated and actual displacement over the bearing surface.

Once the quantities \mathbf{u}_c , θ , α , β , κ_y , and κ_z are known, the part of the displacement which changes the film thickness can be written by removing the axial rotation:

$$\mathbf{u}' = \mathbf{u}_c + (R_{\alpha\beta} - I)(\mathbf{X} - \mathbf{X}_c) + \mathbf{u}_b$$

Therefore, the film thickness expression should use the approximated displacement instead of the displacement only at the center:

$$h(\Theta) \approx C + (\mathbf{u}'^b - \mathbf{u}'^s) \cdot (\mathbf{e}_r(\Theta) - \nabla_t C)$$

The total velocity field of the structure and foundation is used as an input for the journal or collar velocity in the bearing.

The net force and moment due to the pressure distribution in the film then acts as a load on both the structure and the bearing surfaces.

I n d e x

- A** added mass (node) 156
 - applied torque (node) 156
 - axis (node) 140
- B** backlash (node) 168
 - theory 126
- beam rotor bearing coupling (multiphysics coupling) 274
- beam rotor interface 178
- beam rotor with hydrodynamic bearing
 - interface 273
- bearing orientation (node) 263
- bevel gear (node) 160
 - theory 109
- body load (node)
 - solid rotor 152
- border (node)
 - hydrodynamic bearing 264
- boundary load (node)
 - solid rotor 154
- boundary nodes 134
- C** cavitation, thin film flow 210
- change rotor speed (node) 140
- Couette flow 202
- D** domain nodes 134
- E** edge load (node)
 - beam rotor 192
- edge nodes
 - beam rotor 180
- emailing COMSOL 13
- energy quantities 104
- F** film thickness 220
- fixed axial rotation (node)
 - solid rotor 140
- Fixed Foundation 84
- Flexible Foundation 85
- flexible foundation (node)
 - solid rotor 147
- floating ring bearing (node)
 - hydrodynamic bearing 253
- force linear strains (checkbox) 137
- friction- gear (node)
 - theory 128
- friction-gear (node) 169
- G** gaseous cavitation 210
- gear axis (node) 161
- gear elasticity (node) 165
 - theory 119
- gear pair (node) 163
 - theory 111
- gravity (node) 154
- H** helical gear (node) 160
 - theory 108
- hydrodynamic bearing 263
- hydrodynamic journal bearing (node)
 - hydrodynamic bearing 247
- hydrodynamic thrust bearing (node)
 - hydrodynamic bearing 257
- I** initial film thickness 220
- initial values (node)
 - beam rotor 181
 - hydrodynamic bearing 265
 - rigid domains 162
 - solid rotor 135
- inlet (node)
 - hydrodynamic bearing 266
- inner film properties (node)
 - hydrodynamic bearing 255
- inner-outer film connecti (node)
 - hydrodynamic bearing 256

- internet resources 13
- J** journal 197
 - journal bearing (node)
 - beam rotor 185
 - solid rotor 141
 - journal bearings 57
- K** kinetic energy 104
 - knowledge base, COMSOL 14
- L** linear elastic material (node)
 - solid rotor 136
- M** misalignment (node)
 - solid rotor 149
- modified Reynolds equation, gas flow 208
- modified Reynolds equation, thin-film flow 197
- Moving Foundation 85
- moving foundation (node)
 - solid rotor 148
- multilobe journal bearing 223
- multiphysics coupling
 - beam rotor bearing coupling 273
 - beam rotor bearing coupling (node) 274
 - solid rotor bearing coupling 270
 - solid rotor bearing coupling (node) 271
 - solid-bearing coupling (node) 276
- multi-spool bearing (node)
 - solid rotor 150
- O** outer film properties (node)
 - hydrodynamic bearing 256
- outlet (node)
 - hydrodynamic bearing 266
- P** pair nodes 134, 180, 246
 - point load (node)
 - beam rotor 193
 - point nodes
 - beam rotor 180
- Poiseuille flow 202
- R** radial roller bearing (node)
 - beam rotor 188
 - solid rotor 145
- rarefied, general accommodation 252, 260
- rarefied, total accommodation 251, 260
- refpnt variable 133, 179
- regularization factor 128
- rigid body 51
- rigid domain (node)
 - theory 51
- rotor coupling (node)
 - beam rotor 191
 - solid rotor 151
- rotor cross section (node) 182
- S** slip length 209
 - solid rotor bearing coupling (multiphysics coupling) 271
 - solid rotor interface 132
 - solid rotor with hydrodynamic bearing interface 270
 - solid-bearing coupling (multiphysics coupling) 276
 - spur gear (node) 157
 - theory 106
 - Squeeze Film Damper 86
 - squeeze film damper (node)
 - beam rotor 190
 - hydrodynamic bearing 262
 - solid rotor 148
 - strain energy density 104
 - symmetry (node)
 - hydrodynamic bearing 267
- T** technical support, COMSOL 13

- thin-film gas flows 208
- thrust bearing (node)
 - beam rotor 187
 - solid rotor 143
- transmission error (node) 166
 - theory 125
- V** vapor cavitation 210
- variables
 - refpnt 133, 179
- W** wall (node)
 - hydrodynamic bearing 267
- websites, COMSOL 13

