

AC/DC Module

User's Guide

AC/DC Module User's Guide

© 1998–2019 COMSOL

Protected by patents listed on www.comsol.com/patents, and U.S. Patents 7,519,518; 7,596,474; 7,623,991; 8,457,932; 8,954,302; 9,098,106; 9,146,652; 9,323,503; 9,372,673; 9,454,625; and 10,019,544. Patents pending.

This Documentation and the Programs described herein are furnished under the COMSOL Software License Agreement (www.comsol.com/comsol-license-agreement) and may be used or copied only under the terms of the license agreement.

COMSOL, the COMSOL logo, COMSOL Multiphysics, COMSOL Desktop, COMSOL Compiler, COMSOL Server, and LiveLink are either registered trademarks or trademarks of COMSOL AB. All other trademarks are the property of their respective owners, and COMSOL AB and its subsidiaries and products are not affiliated with, endorsed by, sponsored by, or supported by those trademark owners. For a list of such trademark owners, see www.comsol.com/trademarks.

Version: COMSOL 5.5

Contact Information

Visit the Contact COMSOL page at www.comsol.com/contact to submit general inquiries, contact Technical Support, or search for an address and phone number. You can also visit the Worldwide Sales Offices page at www.comsol.com/contact/offices for address and contact information.

If you need to contact Support, an online request form is located at the COMSOL Access page at www.comsol.com/support/case. Other useful links include:

- Support Center: www.comsol.com/support
- Product Download: www.comsol.com/product-download
- Product Updates: www.comsol.com/support/updates
- COMSOL Blog: www.comsol.com/blogs
- Discussion Forum: www.comsol.com/community
- Events: www.comsol.com/events
- COMSOL Video Gallery: www.comsol.com/video
- Support Knowledge Base: www.comsol.com/support/knowledgebase

Part number: CM020101

C o n t e n t s

Chapter 1: Introduction

About the AC/DC Module	16
What Can the AC/DC Module Do?	16
AC/DC Module Physics Interface Guide	17
AC/DC Module Study Availability	21
Common Physics Interface and Feature Settings and Nodes	22
Where Do I Access the Documentation and Application Libraries?	23
Overview of the User's Guide	27

Chapter 2: Review of Electromagnetics

Fundamentals of Electromagnetics	32
Maxwell's Equations.	32
Constitutive Relations	33
Potentials.	35
Reduced Potential PDE Formulations	35
Electromagnetic Energy	36
The Quasi-Static Approximation and the Lorentz Term	38
Material Properties	39
About the Boundary and Physics Interface Conditions	39
Phasors	40
Nonlinear Permanent Magnet Constitutive Relations	41
Effective Nonlinear Magnetic Constitutive Relations	42
The Jiles-Atherton Hysteresis Model	42
References for Electromagnetic Theory	45
Electromagnetic Forces	46
Overview of Forces in Continuum Mechanics	46
Forces on an Elastic Solid Surrounded by Vacuum or Air.	48
Torque	49

Forces in Stationary Fields	49
Forces in a Moving Body	53
Electromagnetic Energy, Coenergy and Virtual Work	55
Electromagnetic Quantities	59
References for the AC/DC Interfaces	61

Chapter 3: Modeling with the AC/DC Module

Preparing for Modeling	64
What Problems Can You Solve?	65
Selecting the Space Dimension for the Model Geometry	66
Simplifying the Geometry Using Boundary Conditions	68
Applying Electromagnetic Sources	69
Selecting a Study Type	70
2D Field Variables	71
About the AC/DC and Nonlinear Magnetic Material Databases	72
Meshing and Solving.	72
Force and Torque Computations	74
Calculating Electromagnetic Forces and Torques	74
Model Examples — Electromagnetic Forces.	75
Coil Features	77
About the Coil Features	77
About the Coil Name	80
Coil Excitation.	80
Coil Groups.	84
Lumped Parameter Calculations	84
The Single-Turn Coil Feature	86
Using Coils in 3D Models	87
Automatic Coil Geometry Analysis	92
Accurate Coil Voltage Calculation	93

Lumped Parameters	95
Calculating Lumped Parameters with Ohm's Law	95
Calculating Lumped Parameters Using the Energy Method	97
Studying Lumped Parameters	98
Lumped Parameter Conversion	99
Stationary Source Sweep	101
Lumped Ports with Voltage Input	103
About Lumped Ports	103
Lumped Port Parameters.	103
S-Parameters and Ports	106
S-Parameters in Terms of Voltage and Electric Field	106
S-Parameter Calculations.	107
S-Parameter Variables	107
Port Sweeps/Manual Terminal Sweeps and Touchstone Export	107
Connecting to Electrical Circuits	108
About Connecting Electrical Circuits to Physics Interfaces	108
Connecting Electrical Circuits Using Predefined Couplings	109
Connecting Electrical Circuits by User-Defined Couplings	109
Solving.	111
Postprocessing.	111
SPICE Import and Export	112
SPICE Import	112
SPICE Export	113
Reference	113

Chapter 4: Electric Field Interfaces

The Electrostatics Interface	116
Domain, Boundary, Edge, Point, and Pair Nodes for the Electrostatics Interface	119
Charge Conservation	121
Conduction Loss (Time-Harmonic)	122

Initial Values	123
Space Charge Density	123
Force Calculation.	124
Zero Charge	125
Ground	125
Electric Potential	126
Surface Charge Density	126
External Surface Charge Accumulation	127
Electric Displacement Field	128
Periodic Condition	128
Thin Low Permittivity Gap	129
Dielectric Shielding	130
Terminal	131
Floating Potential.	133
Distributed Capacitance	135
Line Charge.	135
Line Charge (on Axis)	136
Line Charge (Out-of-Plane)	136
Point Charge	137
Point Charge (on Axis)	138
Charge Cross Section	138
Charge Thickness (Out-of-Plane).	139
Charge Conservation, Piezoelectric.	139
Electrostatic Point Dipole	140
Archie's Law	141
Effective Medium	141
The Electrostatics, Boundary Elements Interface	143
Domain, Boundary, and Edge Nodes for the Electrostatics, Boundary Elements Interface	147
Initial Values	148
Charge Conservation	148
Electric Potential	149
Floating Potential.	149
Ground	149
Surface Charge Density	150
Terminal	150
Zero Charge	151

Electric Scalar-Scalar Potential Coupling	151
---	-----

The Electric Currents Interface **153**

Domain, Boundary, Edge, Point, and Pair Nodes for the Electric Currents Interface	155
Current Conservation	158
Initial Values	160
External Current Density	160
Current Source	161
Electric Insulation	161
Floating Potential	162
Boundary Current Source	163
Normal Current Density	164
Distributed Impedance	164
Terminal	166
Electric Shielding	168
Contact Impedance	169
Electrical Contact	171
Sector Symmetry	172
Line Current Source	173
Line Current Source (on Axis)	173
Point Current Source	174
Point Current Source (on Axis)	174
Electric Point Dipole	175
Electric Point Dipole (on Axis)	176
Piezoresistive Material	176

The Electric Currents in Shells Interface **178**

Layer and Interface Selection Tools	181
Using the Extra Dimension Coordinates	185
Boundary and Edge Nodes for the Electric Currents in Shells Interface	186
Conductive Shell	187
Insulating Layer	187
Boundary Current Source	187
Interface Current Source	188
Interlayer Connection	188
Dielectric Layer	189

Piezoelectric Layer	189
Continuity (Layered Shell)	189
The Electric Currents in Layered Shells Interface	190
The Electric Currents, Single Layer Shell Interface	191
Boundary, Edge, Point, and Pair Nodes for the Electric Currents, Single Layer Shell Interface	194
Current Conservation	195
Initial Values	197
Current Source	197
Change Shell Thickness	197
Normal Current Density	198
Electric Shielding	198
The Electric Currents, Layered Shell Interface	199
The Layer Selection Section	201
Electrical Continuity in the Electric Currents, Layered Shell Interface	205
Using the Extra Dimension Coordinates	205
Boundary and Edge Nodes for the Electric Currents, Layered Shell Interface	206
Layered Shell	207
Interlayer Connection	208
Homogenized Shell Connection	209
Homogenized Shell	209
Varying Thickness	211
Layer Current Source	211
Interface Current Source	212
Electric Currents Solid to Shell Via Boundary	213
Theory for the Electrostatics Interface	214
Charge Relaxation Theory	214
Electrostatics Equations	218
The Electrostatics Interface in Time Dependent or Frequency Domain Studies	218
Effective Material Properties in Effective Media and Mixtures	219
Effective Conductivity in Effective Media and Mixtures	219
Effective Relative Permittivity in Effective Media and Mixtures	220

Effective Relative Permeability in Effective Media and Mixtures	221
Archie's Law Theory	222
Reference for Archie's Law	223
Theory for the Electric Currents Interface	224
Electric Currents Equations in Steady State	224
Dynamic Electric Currents Equations	225
Theory for Electrical Contact	226
Theory for the Electric Currents, Single Layer Shell Interface	229
Electric Currents, Single Layer Shell Equations in Steady State	229
Dynamic Electric Currents Equations	229

Chapter 5: Magnetic Field Interfaces

The Magnetic Fields Interface	232
Domain, Boundary, Point, and Pair Nodes for the Magnetic Fields	
Interface.	236
Ampère's Law	238
Ampère's Law, Magnetostrictive	242
Initial Values	244
External Current Density	244
Velocity (Lorentz Term)	245
Magnetic Insulation	245
Magnetic Field	247
Surface Current Density	247
Surface Magnetic Current Density	248
Magnetic Potential	248
Perfect Magnetic Conductor	248
Line Current (Out-of-Plane)	249
Line Current (on Axis)	249
Electric Point Dipole	250
Gauge Fixing for A-Field	250
Coil	252
Harmonic Perturbation	259

Coil Geometry	259
User Defined Coil Geometry	260
Input (for User Defined Coil Geometry)	261
Output (for User Defined Coil Geometry)	262
Override Coil Inlet/Outlet	262
Geometry Analysis	262
Input (for Geometry Analysis)	263
Output (for Geometry Analysis)	264
Electric Insulation (for Geometry Analysis)	265
Connected Boundaries	266
Single-Turn Coil	267
Gap Feed	270
Boundary Feed	270
Ground	271
Floating Potential	271
Domain Group/Boundary Group	272
Reversed Current Direction	272
Lumped Port	272
Lumped Element	275
Edge Current	276
External Magnetic Vector Potential	276
Impedance Boundary Condition	276
Transition Boundary Condition	278
Thin Low Permeability Gap	279
Magnetic Point Dipole	279
Magnetic Point Dipole (on Axis)	280
Magnetic Shielding	280
The Magnetic Field Formulation Interface	282
Domain, Boundary, Point, and Pair Nodes for the Magnetic Field	
Formulation Interface	284
Faraday's Law	286
Initial Values	286
Magnetic Gauss' Law	286
Magnetic Insulation	287
Electric Field	287
Surface Magnetic Current Density	288

The Magnetic Fields, No Currents Interface	289
Domain, Boundary, Point, and Pair Nodes for the Magnetic Fields, No Currents Interface	291
Magnetic Flux Conservation.	293
Initial Values	294
Magnetic Insulation	294
Magnetic Scalar Potential	294
Magnetic Flux Density	295
Zero Magnetic Scalar Potential	295
External Magnetic Flux Density	296
Magnetic Shielding	296
Magnetic Scalar Potential Discontinuity	297
Thin Low Permeability Gap	297
Archie's Law	298
The Magnetic Fields, No Currents, Boundary Elements Interface	299
Domain and Boundary Nodes for the Magnetic Fields, No Currents, Boundary Elements Interface	302
Magnetic Flux Conservation.	303
Magnetic Insulation	304
Initial Values	304
Zero Magnetic Scalar Potential	304
Magnetic Scalar Potential	304
Magnetic Flux Density	305
Magnetic Scalar-Scalar Potential Coupling	305
Magnetic Vector-Scalar Potential Coupling	306
The Rotating Machinery, Magnetic Interface	308
Domain, Boundary, Edge, Point, and Pair Nodes for the Rotating Machinery, Magnetic Interface	311
Initial Values	312
Electric Field Transformation	313
Prescribed Rotation.	313
Prescribed Rotational Velocity.	313
Magnetic Insulation	314
Mixed Formulation Boundary	314

The Magnetic and Electric Fields Interface	315
About the Magnetic and Electric Field Interface Boundary Conditions . . .	318
Domain, Boundary, Edge, Point, and Pair Nodes for the Magnetic and Electric Fields Interface	321
Ampère's Law and Current Conservation	324
Initial Values	324
Magnetic Insulation	325
Surface Current	325
Magnetic Shielding	325
Magnetic Continuity.	326
RLC Coil Group	327
Theory for the Magnetic Fields Interface	330
Magnetostatics Equation	330
Frequency Domain Equation	331
Transient Equation	331
Maxwell's Equations.	332
Magnetic and Electric Potentials	332
Gauge Transformations	333
Selecting a Particular Gauge.	333
The Gauge and Equation of Continuity for Dynamic Fields	334
Explicit Gauge Fixing/Divergence Constraint	334
Ungauged Formulations and Current Conservation.	335
Time-Harmonic Magnetic Fields	335
Theory for the Magnetic Field Formulation Interface	337
Equation System	337
Theory for the Magnetic Fields, No Currents Interface	340
Theory for the Magnetic and Electric Fields Interface	341
Magnetostatics Equations.	341
Frequency Domain Equations	342

Chapter 6: The Electrical Circuit Interface

The Electrical Circuit Interface	344
Ground Node	346
Voltmeter	346
Ampère Meter.	347
Resistor	347
Capacitor.	347
Inductor	348
Voltage Source	348
Current Source	349
Voltage-Controlled Voltage Source	350
Voltage-Controlled Current Source.	351
Current-Controlled Voltage Source.	351
Current-Controlled Current Source	352
Subcircuit Definition	352
Subcircuit Instance	353
NPN BJT and PNP BJT.	353
n-Channel MOSFET and p-Channel MOSFET	354
Mutual Inductance	355
Transformer	355
Diode	356
External I vs. U	356
External U vs. I	357
External I-Terminal	358
SPICE Circuit Import	359
SPICE Circuit Export	359
Theory for the Electrical Circuit Interface	361
Electric Circuit Modeling and the Semiconductor Device Models.	361
Bipolar Transistors	362
MOSFET Transistors	365
Diode	368
Reference for the Electrical Circuit Interface	370

Chapter 7: Heat Transfer Interfaces

The Induction Heating Interface	372
Electromagnetic Heating	375

Chapter 8: Glossary

Glossary of Terms	378
--------------------------	------------

Introduction

This guide describes the AC/DC Module, an optional add-on package for COMSOL Multiphysics® designed to assist you to solve and model low-frequency electromagnetics.

This chapter introduces you to the capabilities of the module including an introduction to the modeling stages and some realistic and illustrative models. A summary of the physics interfaces and where you can find documentation and model examples is also included. The last section is a brief overview with links to each chapter in this guide.

In this chapter:

- [About the AC/DC Module](#)
- [Overview of the User's Guide](#)

About the AC/DC Module

In this section:

- [What Can the AC/DC Module Do?](#)
- [AC/DC Module Physics Interface Guide](#)
- [AC/DC Module Study Availability](#)
- [Common Physics Interface and Feature Settings and Nodes](#)
- [Where Do I Access the Documentation and Application Libraries?](#)

What Can the AC/DC Module Do?

The AC/DC Module provides a unique environment for simulation of AC/DC electromagnetics in 2D and 3D. The module is a powerful tool for detailed analysis of s, capacitors, and electrical machinery. With this module you can run static, quasi-static, transient, and time-harmonic simulations in an easy-to-use graphical user interface.

The available physics interfaces cover the following types of electromagnetics field simulations:

- Electrostatics
- Electric currents in conductive media
- Magnetostatics
- Low-frequency electromagnetics

Material properties include inhomogeneous and fully anisotropic materials, media with gains or losses, and complex-valued material properties. Infinite elements makes it possible to model unbounded domains. In addition to the standard results and visualization functionality, the module supports direct computation of lumped parameters such as capacitances and inductances as well as electromagnetic forces.

Selected material data are provided with the module.



For detailed information about [Materials](#) including the [AC/DC Materials Database](#) and [Nonlinear Magnetic Materials Database](#), see the *COMSOL Multiphysics Reference Manual*.

Like all COMSOL modules, there is a library of ready-to-run models that make it quicker and easier to analyze discipline-specific problems. In addition, any model you develop is described in terms of the underlying partial differential equations, offering a unique way to see the underlying physical laws of a simulation.

The AC/DC interfaces are fully multiphysics enabled — couple them to any other physics interface in COMSOL Multiphysics or the other modules. For example, to find the heat distribution in a motor, first find the current in the s using one of the quasi-static interfaces in this module and then couple it to a heat equation in the main COMSOL Multiphysics package or the Heat Transfer Module. This forms a powerful *multiphysics* model that solves all the equations simultaneously.

The AC/DC Module also provides interfaces for modeling electrical circuits.



- [Building a COMSOL Multiphysics Model](#) in the *COMSOL Multiphysics Reference Manual*
- [AC/DC Module Physics Interface Guide](#)
- [AC/DC Module Study Availability](#)
- [Common Physics Interface and Feature Settings and Nodes](#)
- [Where Do I Access the Documentation and Application Libraries?](#)

AC/DC Module Physics Interface Guide

The interfaces in the AC/DC Module form a complete set of simulation tools for electromagnetic field simulations. To select the right physics interface for describing the real-life physics, the geometric properties and the time variations of the fields need to be considered. The interfaces solve for these physical quantities — the *electric scalar potential* V , the *magnetic vector potential* \mathbf{A} , and the *magnetic scalar potential* V_m .

Each physics interface has a *tag* which is of special importance when performing multiphysics simulations. This tag helps distinguish between physics interfaces and the variables defined by the physics interface have an underscore plus the physics interface tag appended to their names.

The *Model Wizard* is an easy way to select the physics interface and study type when creating a model for the first time, and physics interfaces can be added to an existing model at any time. Full instructions for selecting interfaces and setting up a model are in the *COMSOL Multiphysics Reference Manual*.

In 2D, in-plane and out-of-plane variants are available for problems with a planar symmetry as well as axisymmetric interfaces for problems with a cylindrical symmetry.







When using an axisymmetric physics interface it is important that the horizontal axis represents the r direction and the vertical axis the z direction, and that the geometry in the right half plane (that is, for positive r only) must be created.









See [What Problems Can You Solve?](#) and [Table 1-1](#) for information about the available study types and variables. See also [Overview of the User's Guide](#) for links to the chapters in this guide.





In the *COMSOL Multiphysics Reference Manual*:

- [Studies and Solvers](#)
- [The Physics Interfaces](#)
- For a list of all the core physics interfaces included with a COMSOL Multiphysics license, see [Physics Interface Guide](#).

PHYSICS INTERFACE	ICON	TAG	SPACE DIMENSION	AVAILABLE STUDY TYPE
 AC/DC				
Electric Currents ¹		ec	all dimensions	stationary; stationary source sweep; frequency domain; time dependent; small signal analysis, frequency domain
Electric Currents in Shells		ecis	3D	stationary; frequency domain; time dependent
Electric Currents in Layered Shells		ecis	3D	stationary; frequency domain; time dependent
Electrical Circuit		cir	Not space dependent	stationary; frequency domain; time dependent; small signal analysis, frequency domain

PHYSICS INTERFACE	ICON	TAG	SPACE DIMENSION	AVAILABLE STUDY TYPE
Electrostatics ¹		es	all dimensions	stationary; time dependent; stationary source sweep; eigenfrequency; frequency domain; small signal analysis, frequency domain
Electrostatics, Boundary Elements		esbe	3D, 2D	stationary; stationary source sweep; frequency domain; small signal analysis, frequency domain
Magnetic Fields ¹		mf	3D, 2D, 2D axisymmetric	stationary; frequency domain; time dependent; small signal analysis, frequency domain; coil geometry analysis (3D only)
Magnetic Field Formulation		mfh	3D, 2D, 2D axisymmetric	stationary; frequency domain; time dependent; small signal analysis, frequency domain
Magnetic Fields, No Currents		mfnc	3D, 2D, 2D axisymmetric	stationary; frequency domain; time dependent
Magnetic Fields, No Currents, Boundary Elements		mfncbe	3D, 2D	stationary
Magnetic and Electric Fields		mef	3D, 2D, 2D axisymmetric	stationary; frequency domain; small signal analysis, frequency domain; coil geometry analysis (3D only)
Rotating Machinery, Magnetic		rmm	3D, 2D	stationary; time dependent, coil geometry analysis (3D only)
🔥 Heat Transfer				
⚡ Electromagnetic Heating				

PHYSICS INTERFACE	ICON	TAG	SPACE DIMENSION	AVAILABLE STUDY TYPE
Induction Heating ²		—	3D, 2D, 2D axisymmetric	stationary; time dependent; frequency-stationary; frequency-transient; frequency-stationary, one-way coupled, electromagnetic heating; frequency-transient, one-way coupled, electromagnetic heating; small-signal analysis, frequency domain
Joule Heating ^{1,2}		—	all dimensions	stationary; time dependent; frequency-transient; small-signal analysis; frequency domain; frequency-stationary; frequency-stationary, one-way coupled, electromagnetic heating; frequency-transient, one-way coupled, electromagnetic heating
¹ This physics interface is included with the core COMSOL package but has added functionality for this module.				
² This physics interface is a predefined multiphysics coupling that automatically adds all the physics interfaces and coupling features required.				

AC/DC Module Study Availability

TABLE I-1: AC/DC MODULE DEPENDENT VARIABLES, FIELD COMPONENTS, AND PRESET STUDY AVAILABILITY

PHYSICS INTERFACE	TAG	DEPENDENT VARIABLES	FIELD COMPONENTS *				PRESET STUDIES **						
			MAGNETIC FIELD	ELECTRIC FIELD	MAGNETIC POTENTIAL	CURRENT DENSITY	STATIONARY	TIME DEPENDENT	FREQUENCY DOMAIN	SMALL-SIGNAL ANALYSIS, FREQUENCY DOMAIN	FREQUENCY-STATIONARY	FREQUENCY-TRANSIENT	
Electrostatics	es	V		x y z			√	√	√	√			
Electrostatics, Boundary Elements	esbe	V		x y z			√						
Electric Currents	ec	V		x y z		x y z	√	√	√	√			
Electric Currents in Shells	ecis	V		x y z		x y z	√	√	√	√			
Electric Currents in Layered Shells	ecis	V		x y z		x y z	√	√	√	√			
Magnetic Fields	mf	\mathbf{A}	x y z	x y z	x y z	x y z	√	√	√	√			
Magnetic Field Formulation	mfh	\mathbf{H}	x y z				√	√	√	√			
Magnetic and Electric Fields	mef	V, \mathbf{A}	x y z	x y z	x y z	x y z	√		√	√			
Magnetic Fields, No Currents	mfnc	V_m	x y z				√	√					

TABLE I-1: AC/DC MODULE DEPENDENT VARIABLES, FIELD COMPONENTS, AND PRESET STUDY AVAILABILITY

PHYSICS INTERFACE	TAG	DEPENDENT VARIABLES	FIELD COMPONENTS *				PRESET STUDIES **						
			MAGNETIC FIELD	ELECTRIC FIELD	MAGNETIC POTENTIAL	CURRENT DENSITY	STATIONARY	TIME DEPENDENT	FREQUENCY DOMAIN	SMALL-SIGNAL ANALYSIS, FREQUENCY DOMAIN	FREQUENCY-STATIONARY	FREQUENCY-TRANSIENT	
Magnetic Fields, No Currents, Boundary Elements	mfnbcbe	V_m	x y z				√						
Rotating Machinery, Magnetic	rmm	\mathbf{A}, V_m	x y	z	z	z	√	√					
Electrical Circuit	cir	not applicable					√	√	√				
Induction Heating	—	$\mathbf{A}, \mathbf{T}, \mathbf{J}$	x y z	x y z	x y z	x y z	√	√	√			√	√

* These are the nonzero field components. For Cartesian coordinates, these are indexed by x , y , and z ; for cylindrical coordinates, r , ϕ , and z are used.

** Custom studies are also available based on the physics interface, for example, Eigenfrequency and Eigenvalue.



- [Studies and Solvers](#) in the *COMSOL Multiphysics Reference Manual*
- [What Can the AC/DC Module Do?](#)
- [AC/DC Module Physics Interface Guide](#)
- [Where Do I Access the Documentation and Application Libraries?](#)

Common Physics Interface and Feature Settings and Nodes

There are several common settings and sections available for the physics interfaces and feature nodes. Some of these sections also have similar settings or are implemented in the same way no matter the physics interface or feature being used. There are also some physics feature nodes that display in COMSOL Multiphysics.

In each module's documentation, only unique or extra information is included; standard information and procedures are centralized in the *COMSOL Multiphysics Reference Manual*.



In the *COMSOL Multiphysics Reference Manual* see [Table 2-4](#) for links to common sections and [Table 2-5](#) to common feature nodes. You can also search for information: press F1 to open the **Help** window or Ctrl+F1 to open the **Documentation** window.

Where Do I Access the Documentation and Application Libraries?

A number of internet resources have more information about COMSOL, including licensing and technical information. The electronic documentation, topic-based (or context-based) help, and the application libraries are all accessed through the COMSOL Desktop.



If you are reading the documentation as a PDF file on your computer, the [blue links](#) do not work to open an application or content referenced in a different guide. However, if you are using the Help system in COMSOL Multiphysics, these links work to open other modules, application examples, and documentation sets.



THE DOCUMENTATION AND ONLINE HELP

The *COMSOL Multiphysics Reference Manual* describes the core physics interfaces and functionality included with the COMSOL Multiphysics license. This book also has instructions about how to use COMSOL Multiphysics and how to access the electronic Documentation and Help content.

Opening Topic-Based Help

The Help window is useful as it is connected to the features in the COMSOL Desktop. To learn more about a node in the Model Builder, or a window on the Desktop, click to highlight a node or window, then press F1 to open the Help window, which then

displays information about that feature (or click a node in the Model Builder followed by the **Help** button (). This is called *topic-based* (or *context*) *help*.

Win	<p>To open the Help window:</p> <ul style="list-style-type: none">• In the Model Builder, Application Builder, or Physics Builder click a node or window and then press F1.• On any toolbar (for example, Home, Definitions, or Geometry), hover the mouse over a button (for example, Add Physics or Build All) and then press F1.• From the File menu, click Help ().• In the upper-right corner of the COMSOL Desktop, click the Help () button.
-----	--

Mac	<p>To open the Help window:</p> <ul style="list-style-type: none">• In the Model Builder or Physics Builder click a node or window and then press F1.• On the main toolbar, click the Help () button.• From the main menu, select Help>Help.
Linux	

Opening the Documentation Window

Win	<p>To open the Documentation window:</p> <ul style="list-style-type: none">• Press Ctrl+F1.• From the File menu select Help>Documentation ().
-----	---

Mac	<p>To open the Documentation window:</p> <ul style="list-style-type: none">• Press Ctrl+F1.• On the main toolbar, click the Documentation () button.• From the main menu, select Help>Documentation.
Linux	

THE APPLICATION LIBRARIES WINDOW

Each model or application includes documentation with the theoretical background and step-by-step instructions to create a model or application. The models and applications are available in COMSOL Multiphysics as MPH files that you can open for further investigation. You can use the step-by-step instructions and the actual models as templates for your own modeling. In most models, SI units are used to describe the relevant properties, parameters, and dimensions, but other unit systems are available.

Once the Application Libraries window is opened, you can search by name or browse under a module folder name. Click to view a summary of the model or application and its properties, including options to open it or its associated PDF document.





[The Application Libraries Window](#) in the *COMSOL Multiphysics Reference Manual*.

Opening the Application Libraries Window

To open the **Application Libraries** window ():



- From the **Home** toolbar, **Windows** menu, click () **Applications Libraries**.
- From the **File** menu select **Application Libraries**.

To include the latest versions of model examples, from the **File>Help** menu, select () **Update COMSOL Application Library**.



Select **Application Libraries** from the main **File>** or **Windows>** menus.



To include the latest versions of model examples, from the **Help** menu select () **Update COMSOL Application Library**.

CONTACTING COMSOL BY EMAIL

For general product information, contact COMSOL at info@comsol.com.

COMSOL ACCESS AND TECHNICAL SUPPORT

To receive technical support from COMSOL for the COMSOL products, please contact your local COMSOL representative or send your questions to

support@comsol.com. An automatic notification and a case number are sent to you by email. You can also access technical support, software updates, license information, and other resources by registering for a COMSOL Access account.

COMSOL ONLINE RESOURCES

COMSOL website	www.comsol.com
Contact COMSOL	www.comsol.com/contact
COMSOL Access	www.comsol.com/access
Support Center	www.comsol.com/support
Product Download	www.comsol.com/product-download
Product Updates	www.comsol.com/support/updates
COMSOL Blog	www.comsol.com/blogs
Discussion Forum	www.comsol.com/community
Events	www.comsol.com/events
COMSOL Video Gallery	www.comsol.com/video
Support Knowledge Base	www.comsol.com/support/knowledgebase

Overview of the User's Guide

The *AC/DC Module User's Guide* gets you started with modeling using COMSOL Multiphysics. The information in this guide is specific to this module. Instructions how to use COMSOL in general are included with the *COMSOL Multiphysics Reference Manual*.



As detailed in the section [Where Do I Access the Documentation and Application Libraries?](#) this information can also be searched from the COMSOL Multiphysics software **Help** menu.

TABLE OF CONTENTS, GLOSSARY, AND INDEX

To help you navigate through this guide, see the [Contents](#), [Glossary](#), and [Index](#).

THEORY OF ELECTROMAGNETICS

In the [Review of Electromagnetics](#) chapter contains an overview of the theory behind the AC/DC Module. It is intended for readers that want to understand what goes on in the background when using the physics interfaces and discusses the [Fundamentals of Electromagnetics](#), [Electromagnetic Forces](#), and [Electromagnetic Quantities](#).

MODELING WITH THE AC/DC MODULE

In the [Modeling with the AC/DC Module](#) chapter, the goal is to familiarize you with the modeling procedure using this particular module. Topics include [Preparing for Modeling](#), [Force and Torque Computations](#), [Lumped Parameters](#), [Connecting to Electrical Circuits](#).

ELECTRIC FIELDS

[Electric Field Interfaces](#) chapter describes these interfaces and includes the underlying theory for each physics interface at the end of the chapter:

- [The Electrostatics Interface](#), which simulates electric fields in dielectric materials with a fixed or slowly-varying charge present. Preset Stationary, Stationary Source Sweep, Time Dependent, Frequency Domain, and Small-Signal Analysis study types are available.
- [The Electrostatics, Boundary Elements Interface](#), which simulates electric fields in dielectric materials with a fixed charge present. Preset Stationary and Stationary Source Sweep study types are available.

- [The Electric Currents Interface](#), which simulates the current in a conductive and capacitive material under the influence of an electric field. Preset Stationary, Stationary Source Sweep, Time Dependent, Frequency Domain, and Small-Signal Analysis study types are available.
- [The Electric Currents in Shells Interface](#), computes electric fields, currents, and potential distributions in thin conducting layered shells under conditions where inductive effects are negligible; that is, when the skin depth is much larger than the studied device. Preset Stationary, Time Dependent, Frequency Domain, and Small-Signal Analysis study types are available.
- [The Electric Currents in Layered Shells Interface](#), which is very similar to [The Electric Currents in Shells Interface](#).

MAGNETIC FIELDS

[Magnetic Field Interfaces](#) chapter describes these interfaces and includes the underlying theory for each physics interface at the end of the chapter:

- [The Magnetic Fields Interface](#), which handles problems for magnetic fields with source currents, solving for the magnetic vector potential and, for voltage driven s, the scalar electric potential. Preset Stationary, Time Dependent, Frequency Domain, and Small-Signal Analysis study types are available. This is the recommended primary choice for modeling of magnetic fields involving source currents.
- [The Magnetic Field Formulation Interface](#) has the equations, boundary conditions, and currents for modeling magnetic fields, solving for the magnetic field. It is especially suitable for modeling involving nonlinear conductivity effects, for example in superconductors. Preset Stationary, Time Dependent, Frequency Domain, and Small-Signal Analysis study types are available.
- [The Magnetic Fields, No Currents Interface](#), which handles magnetic fields without currents. When no currents are present, the problem is easier to solve using the magnetic scalar potential. Thus it is the primary choice for modeling permanent magnets. Preset Stationary and Time Dependent study types are available.
- [The Magnetic Fields, No Currents, Boundary Elements Interface](#), which handles magnetic fields without currents using the boundary element method. It can be combined with the Magnetic Fields or Magnetic Fields, No Currents interfaces for easy modeling of open boundary conditions. The preset Stationary study type is available.
- [The Rotating Machinery, Magnetic Interface](#) combines a Magnetic Fields formulation (magnetic vector potential) and Magnetic Fields, No Currents

formulation (magnetic scalar potential) with a selection of predefined frames for prescribed rotation or rotational velocity - most of its features are taken either from the Magnetic Fields or the Magnetic Fields, No Currents interfaces. Preset Stationary and Time Dependent study types are available.

- [The Magnetic and Electric Fields Interface](#) computes magnetic field and current distributions when the exciting current is driven by an applied voltage. In most cases, using the Magnetic Fields interface with its dedicated modeling features is the preferred choice over using the Magnetic and Electric Fields interface. Preset Stationary and Frequency Domain study types are available.

ELECTRICAL CIRCUIT

[The Electrical Circuit Interface](#) chapter describes the physics interface, which has the equations for modeling electrical circuits with or without connections to a distributed fields model, solving for the voltages, currents, and charges associated with the circuit elements. The underlying theory for the physics interface is included at the end of the chapter. Preset Stationary, Time Dependent and Frequency Domain study types are available.

HEAT TRANSFER

[Heat Transfer Interfaces](#) chapter describes the physics interface, which combines all physics features from the Magnetic Fields interface in the time harmonic formulation with the Heat Transfer interface for modeling of induction and eddy current heating.

Heat transfer through conduction and convection in solids and free media (fluids) is supported by physics interfaces shipped with the basic COMSOL Multiphysics license.



[The Heat Transfer Interfaces](#), [The Joule Heating Interface](#), and [Theory for Heat Transfer](#) in the *COMSOL Multiphysics Reference Manual*.

Review of Electromagnetics

This chapter contains an overview of the theory behind the AC/DC Module. It is intended for readers that want to understand what goes on in the background when using the physics interfaces.

In this chapter:

- [Fundamentals of Electromagnetics](#)
- [Electromagnetic Forces](#)
- [Electromagnetic Quantities](#)
- [References for the AC/DC Interfaces](#)

Fundamentals of Electromagnetics

In this section:

- Maxwell's Equations
- Constitutive Relations
- Potentials
- Reduced Potential PDE Formulations
- Electromagnetic Energy
- The Quasi-Static Approximation and the Lorentz Term
- Material Properties
- About the Boundary and Physics Interface Conditions
- Phasors
- Nonlinear Permanent Magnet Constitutive Relations
- Effective Nonlinear Magnetic Constitutive Relations
- The Jiles-Atherton Hysteresis Model
- References for Electromagnetic Theory

Maxwell's Equations

The problem of electromagnetic analysis on a macroscopic level is that of solving *Maxwell's equations* subject to certain boundary conditions. Maxwell's equations are a set of equations, written in differential or integral form, stating the relationships between the fundamental electromagnetic quantities. These quantities are:

- Electric field intensity **E**
- Electric displacement or electric flux density **D**
- Magnetic field intensity **H**
- Magnetic flux density **B**
- Current density **J**
- Electric charge density ρ

The equations can be formulated in differential form or integral form. The differential form is presented here because it leads to differential equations that the finite element

method can handle. For general time-varying fields, Maxwell's equations can be written as:

$$\begin{aligned}\nabla \times \mathbf{H} &= \mathbf{J} + \frac{\partial \mathbf{D}}{\partial t} \\ \nabla \times \mathbf{E} &= -\frac{\partial \mathbf{B}}{\partial t} \\ \nabla \cdot \mathbf{D} &= \rho \\ \nabla \cdot \mathbf{B} &= 0\end{aligned}$$

The first two equations are also referred to as *Maxwell-Ampère's law* and *Faraday's law*, respectively. Equation three and four are two forms of *Gauss' law*: the electric and magnetic form, respectively.

Another fundamental equation is the *equation of continuity*

$$\nabla \cdot \mathbf{J} = -\frac{\partial \rho}{\partial t}$$

Out of the five equations mentioned, only three are independent. The first two combined with either the electric form of Gauss' law or the equation of continuity form such an independent system.

Constitutive Relations

To obtain a closed system, the equations include *constitutive relations* that describe the macroscopic properties of the medium. They are given as:

$$\begin{aligned}\mathbf{D} &= \epsilon_0 \mathbf{E} + \mathbf{P} \\ \mathbf{B} &= \mu_0 (\mathbf{H} + \mathbf{M}) \\ \mathbf{J} &= \sigma \mathbf{E}\end{aligned}\tag{2-1}$$

where ϵ_0 is the permittivity of vacuum, μ_0 is the permeability of vacuum, and σ is the electrical conductivity. In the SI units system, the permeability of vacuum is proportional to the dimensionless fine-structure constant and it has an approximate value $4\pi \cdot 10^{-7}$ H/m. The velocity of an electromagnetic wave in a vacuum is given as c_0 and the permittivity of a vacuum is derived from the relation:

$$\epsilon_0 = \frac{1}{c_0^2 \mu_0} \approx 8.854 \cdot 10^{-12} \text{ F/m} \approx \frac{1}{36\pi} \cdot 10^{-9} \text{ F/m}$$

The electromagnetic constants ϵ_0 , μ_0 , and c_0 are available in COMSOL Multiphysics as predefined physical constants.

The *electric polarization vector* \mathbf{P} describes how the material is polarized when an electric field \mathbf{E} is present. It can be interpreted as the volume density of *electric dipole* moments. \mathbf{P} is generally a function of \mathbf{E} . Some materials can have a nonzero \mathbf{P} also when there is no electric field present.

The *magnetization vector* \mathbf{M} similarly describes how the material is magnetized when a magnetic field \mathbf{H} is present. It can be interpreted as the volume density of *magnetic dipole* moments. \mathbf{M} is generally a function of \mathbf{H} . Permanent magnets, for instance, have a nonzero \mathbf{M} also when there is no magnetic field present.

For linear materials, the polarization is directly proportional to the electric field, $\mathbf{P} = \epsilon_0 \chi_e \mathbf{E}$, where χ_e is the electric susceptibility. Similarly in linear materials, the magnetization is directly proportional to the magnetic field, $\mathbf{M} = \chi_m \mathbf{H}$, where χ_m is the magnetic susceptibility. For such materials, the constitutive relations are:

$$\begin{aligned}\mathbf{D} &= \epsilon_0(1 + \chi_e)\mathbf{E} = \epsilon_0\epsilon_r\mathbf{E} = \epsilon\mathbf{E} \\ \mathbf{B} &= \mu_0(1 + \chi_m)\mathbf{H} = \mu_0\mu_r\mathbf{H} = \mu\mathbf{H}\end{aligned}$$

The parameter ϵ_r is the relative permittivity and μ_r is the relative permeability of the material. Usually these are scalar properties but can, in the general case, be 3-by-3 tensors when the material is anisotropic. The properties ϵ and μ (without subscripts) are the permittivity and permeability of the material, respectively.

GENERALIZED CONSTITUTIVE RELATIONS



The [Charge Conservation](#) node describes the macroscopic properties of the medium (relating the electric displacement \mathbf{D} with the electric field \mathbf{E}) and the applicable material properties.

For nonlinear materials, a generalized form of the constitutive relationships is useful. The relationship used for electric fields is $\mathbf{D} = \epsilon_0\epsilon_r\mathbf{E} + \mathbf{D}_r$, where \mathbf{D}_r is the *remanent displacement*, which is the displacement when no electric field is present.

Similarly, a generalized form of the constitutive relation for the magnetic field is

$$\mathbf{B} = \mu_0\mu_r\mathbf{H} + \mathbf{B}_r$$

where \mathbf{B}_r is the *remanent magnetic flux density*, which is the magnetic flux density when no magnetic field is present.

For some materials, there is a nonlinear relationship between \mathbf{B} and \mathbf{H} such that

$$\mathbf{B} = f(|\mathbf{H}|)$$

The relation defining the current density is generalized by introducing an externally generated current \mathbf{J}_e . The resulting constitutive relation is $\mathbf{J} = \sigma\mathbf{E} + \mathbf{J}_e$.

Potentials

Under certain circumstances, it can be helpful to formulate the problems in terms of the electric scalar potential V and the magnetic vector potential \mathbf{A} . They are given by the equalities:

$$\begin{aligned}\mathbf{B} &= \nabla \times \mathbf{A} \\ \mathbf{E} &= -\nabla V - \frac{\partial \mathbf{A}}{\partial t}\end{aligned}$$

The defining equation for the magnetic vector potential is a direct consequence of the magnetic Gauss' law. The electric potential results from Faraday's law. In the magnetostatic case where there are no currents present, Maxwell-Ampère's law reduces to $\nabla \times \mathbf{H} = \mathbf{0}$. When this holds, it is also possible to define a magnetic scalar potential by the relation $\mathbf{H} = -\nabla V_m$.

Reduced Potential PDE Formulations

The *reduced potential* option is useful for models involving a uniform or known external background field, usually originating from distant sources that might be expensive or inconvenient to include in the model geometry. A typical example is when analyzing induced magnetization in ferromagnetic objects such as ships or vehicles due to the Earth's magnetic field. The strategy is then to solve only for the induced fields represented by the reduced vector potential \mathbf{A}_{red} , introducing the substitution $\mathbf{A} = \mathbf{A}_{\text{red}} + \mathbf{A}_{\text{ext}}$, where \mathbf{A}_{ext} represents the known background field, into Maxwell-Ampère's law:

$$\nabla \times (\mu^{-1} \nabla \times \mathbf{A}) = \mathbf{J} + \frac{d\mathbf{D}}{dt}$$

DOMAIN EQUATIONS

Time-Harmonic

For time-harmonic quasi-static systems solving for an A formulation, the reduced potential formulation results in the following PDE:

$$(j\omega\sigma - \omega^2\varepsilon)(\mathbf{A}_{\text{ext}} + \mathbf{A}_{\text{red}}) + \nabla \times (\mu^{-1} \nabla \times (\mathbf{A}_{\text{ext}} + \mathbf{A}_{\text{red}})) = \mathbf{J}_e$$

Here it is possible to interpret the term $\nabla \times \mathbf{A}_{\text{ext}}$ as an additional remanent magnetic flux density and the term $(j\omega\sigma - \omega^2\varepsilon)\mathbf{A}_{\text{ext}}$ as an additional external current source.

Transient

Similarly to the time-harmonic formulation, in the transient formulation, the above substitution results in the reduced equation

$$\sigma \frac{\partial}{\partial t} (\mathbf{A}_{\text{ext}} + \mathbf{A}_{\text{red}}) + \nabla \times (\mu^{-1} \nabla \times (\mathbf{A}_{\text{ext}} + \mathbf{A}_{\text{red}})) = \mathbf{J}_e$$

Static

In static formulations, the induced current is zero. Maxwell-Ampère's law reduces to:

$$\nabla \times (\mu^{-1} \nabla \times (\mathbf{A}_{\text{ext}} + \mathbf{A}_{\text{red}})) = \mathbf{J}_e$$

In this case it is also possible to express the external field through a known external magnetic flux density, \mathbf{B}_{ext} . The domain equation in reduced form then reads:

$$\nabla \times (\mu^{-1} (\nabla \times \mathbf{A}_{\text{red}} + \mathbf{B}_{\text{ext}})) = \mathbf{J}_e$$

Electromagnetic Energy

The electric and magnetic energies are defined as:

$$W_e = \int_V \left(\int_0^D \mathbf{E} \cdot d\mathbf{D} \right) dV = \int_V \left(\int_0^T \mathbf{E} \cdot \frac{\partial \mathbf{D}}{\partial t} dt \right) dV$$
$$W_m = \int_V \left(\int_0^B \mathbf{H} \cdot d\mathbf{B} \right) dV = \int_V \left(\int_0^T \mathbf{H} \cdot \frac{\partial \mathbf{B}}{\partial t} dt \right) dV$$

The time derivatives of these expressions are the electric and magnetic power:

$$P_e = \int_V \mathbf{E} \cdot \frac{\partial \mathbf{D}}{\partial t} dV$$

$$P_m = \int_V \mathbf{H} \cdot \frac{\partial \mathbf{B}}{\partial t} dV$$

These quantities are related to the resistive and radiative energy, or energy loss, through Poynting's theorem (Ref. 1)

$$-\int_V \left(\mathbf{E} \cdot \frac{\partial \mathbf{D}}{\partial t} + \mathbf{H} \cdot \frac{\partial \mathbf{B}}{\partial t} \right) dV = \int_V \mathbf{J} \cdot \mathbf{E} dV + \oint_S (\mathbf{E} \times \mathbf{H}) \cdot \mathbf{n} dS$$

where V is the computation domain and S is the closed boundary of V .

The first term on the right-hand side represents the resistive losses,

$$P_h = \int_V \mathbf{J} \cdot \mathbf{E} dV$$

which result in heat dissipation in the material. (The current density \mathbf{J} in this expression is the one appearing in Maxwell-Ampère's law.)

The second term on the right-hand side of Poynting's theorem represents the radiative losses,

$$P_r = \oint_S (\mathbf{E} \times \mathbf{H}) \cdot \mathbf{n} dS$$

The quantity $\mathbf{S} = \mathbf{E} \times \mathbf{H}$ is called the Poynting vector.

Under the assumption the material is linear and isotropic, it holds that:

$$\mathbf{E} \cdot \frac{\partial \mathbf{D}}{\partial t} = \epsilon \mathbf{E} \cdot \frac{\partial \mathbf{E}}{\partial t} = \frac{\partial}{\partial t} \left(\frac{1}{2} \epsilon \mathbf{E} \cdot \mathbf{E} \right)$$

$$\mathbf{H} \cdot \frac{\partial \mathbf{B}}{\partial t} = \frac{1}{\mu} \mathbf{B} \cdot \frac{\partial \mathbf{B}}{\partial t} = \frac{\partial}{\partial t} \left(\frac{1}{2\mu} \mathbf{B} \cdot \mathbf{B} \right)$$

By interchanging the order of differentiation and integration (justified by the fact that the volume is constant and the assumption that the fields are continuous in time), the result is:

$$-\frac{\partial}{\partial t} \int_V \left(\frac{1}{2} \epsilon \mathbf{E} \cdot \mathbf{E} + \frac{1}{2\mu} \mathbf{B} \cdot \mathbf{B} \right) dV = \int_V \mathbf{J} \cdot \mathbf{E} dV + \oint_S (\mathbf{E} \times \mathbf{H}) \cdot \mathbf{n} dS$$

The integrand of the left-hand side is the total electromagnetic energy density:

$$w = w_e + w_m = \frac{1}{2}\epsilon \mathbf{E} \cdot \mathbf{E} + \frac{1}{2\mu} \mathbf{B} \cdot \mathbf{B}$$

The Quasi-Static Approximation and the Lorentz Term

A consequence of Maxwell's equations is that changes in time of currents and charges are not synchronized with changes of the electromagnetic fields. The changes of the fields are always delayed relative to the changes of the sources, reflecting the finite speed of propagation of electromagnetic waves. Under the assumption that this effect can be ignored, it is possible to obtain the electromagnetic fields by considering stationary currents at every instant. This is called the *quasi-static approximation*. The approximation is valid provided that the variations in time are small and that the studied geometries are considerably smaller than the wavelength (Ref. 5).

The quasi-static approximation implies that the equation of continuity can be written as $\nabla \cdot \mathbf{J} = 0$ and that the time derivative of the electric displacement $\partial \mathbf{D} / \partial t$ can be disregarded in Maxwell-Ampère's law.

There are also effects of the motion of the geometries. Consider a geometry moving with velocity \mathbf{v} relative to the reference system. The force per unit charge, \mathbf{F}/q , is then given by the *Lorentz force equation*:

$$\frac{\mathbf{F}}{q} = \mathbf{E} + \mathbf{v} \times \mathbf{B}$$

This means that to an observer traveling with the geometry, the force on a charged particle can be interpreted as caused by an electric field $\mathbf{E}' = \mathbf{E} + \mathbf{v} \times \mathbf{B}$. In a conductive medium, the observer accordingly sees the current density

$$\mathbf{J} = \sigma(\mathbf{E} + \mathbf{v} \times \mathbf{B}) + \mathbf{J}_e$$

where \mathbf{J}_e is an externally generated current density.

Maxwell-Ampère's law for quasi-static systems is consequently extended to

$$\nabla \times \mathbf{H} = \sigma(\mathbf{E} + \mathbf{v} \times \mathbf{B}) + \mathbf{J}_e$$

whereas Faraday's law remains unchanged.

Material Properties

Until now, there has only been a formal introduction of the constitutive relations. These seemingly simple relations can be quite complicated at times. There are four main groups of materials for which they require some consideration. A given material can belong to one or more of these groups.

Inhomogeneous Materials Inhomogeneous materials are the least complicated. An inhomogeneous medium is one in which the constitutive parameters vary with the space coordinates so that different field properties prevail at different parts of the material structure.

Anisotropic Materials For anisotropic materials, the field relationships at any point differ for different directions of propagation. This means that a 3-by-3 tensor is necessary to properly define the constitutive relationships. If this tensor is symmetric, the material is often referred to as *reciprocal*. In such cases, rotate the coordinate system such that a diagonal matrix results. If two of the diagonal entries are equal, the material is *uniaxially anisotropic*. If none of the elements have the same value, the material is *biaxially anisotropic* (Ref. 2). Anisotropic parameters are needed, for example, to examine permittivity in crystals (Ref. 2) and when working with conductivity in solenoids.

Nonlinear Materials Nonlinearity is the effect of variations in permittivity or permeability with the intensity of the electromagnetic field. Nonlinearity also includes hysteresis effects, where not only the current field intensities influence the physical properties of the material, but also the history of the field distribution.

Dispersive Materials Dispersion describes changes in a wave's velocity with wavelength. In the frequency domain, dispersion is expressed with a frequency dependence of the constitutive laws.

About the Boundary and Physics Interface Conditions

To get a full description of an electromagnetics problem, boundary conditions must be specified at material interfaces and physical boundaries. At interfaces between two media, the boundary conditions can be expressed mathematically as

$$\begin{aligned}
\mathbf{n}_2 \times (\mathbf{E}_1 - \mathbf{E}_2) &= \mathbf{0} \\
\mathbf{n}_2 \cdot (\mathbf{D}_1 - \mathbf{D}_2) &= \rho_s \\
\mathbf{n}_2 \times (\mathbf{H}_1 - \mathbf{H}_2) &= \mathbf{J}_s \\
\mathbf{n}_2 \cdot (\mathbf{B}_1 - \mathbf{B}_2) &= 0
\end{aligned}$$

where ρ_s and \mathbf{J}_s denote surface charge density and surface current density, respectively, and \mathbf{n}_2 is the outward normal from medium two. Of these four conditions, only two are independent. This is an overdetermined system of equations, so it needs to be reduced. First select either equation one or equation four. Then select either equation two or equation three. Together these selections form a set of two independent conditions.

From these relationships, the interface condition is derived for the current density,

$$\mathbf{n}_2 \cdot (\mathbf{J}_1 - \mathbf{J}_2) = -\frac{\partial \rho_s}{\partial t}$$

INTERFACE BETWEEN A DIELECTRIC AND A PERFECT CONDUCTOR

A perfect conductor has infinite electrical conductivity and thus no internal electric field. Otherwise, it would produce an infinite current density according to the third fundamental constitutive relation. At an interface between a dielectric and a perfect conductor, the boundary conditions for the \mathbf{E} and \mathbf{D} fields are simplified. Assume that subscript 1 corresponds to a perfect conductor; then $\mathbf{D}_1 = \mathbf{0}$ and $\mathbf{E}_1 = \mathbf{0}$ in the relationships just given. If it is a time-varying case, then $\mathbf{B}_1 = \mathbf{0}$ and $\mathbf{H}_1 = \mathbf{0}$ as well, as a consequence of Maxwell's equations. The result is the following set of boundary conditions for the fields in the dielectric medium for the time-varying case:

$$\begin{aligned}
-\mathbf{n}_2 \times \mathbf{E}_2 &= 0 \\
-\mathbf{n}_2 \times \mathbf{H}_2 &= \mathbf{J}_s \\
-\mathbf{n}_2 \cdot \mathbf{D}_2 &= \rho_s \\
-\mathbf{n}_2 \cdot \mathbf{B}_2 &= 0
\end{aligned}$$

Phasors

Whenever a problem is time-harmonic the fields can be written in the form:

$$\mathbf{E}(\mathbf{r}, t) = \hat{\mathbf{E}}(\mathbf{r}) \cos(\omega t + \phi)$$

Instead of using a cosine function for the time dependence, it is more convenient to use an exponential function, by writing the field as:

$$\mathbf{E}(\mathbf{r}, t) = \hat{\mathbf{E}}(\mathbf{r}) \cos(\omega t + \phi) = \text{Re}(\hat{\mathbf{E}}(\mathbf{r})e^{j\phi}e^{j\omega t}) = \text{Re}(\tilde{\mathbf{E}}(\mathbf{r})e^{j\omega t})$$

The field $\tilde{\mathbf{E}}(\mathbf{r})$ is a *phasor*, which contains amplitude and phase information of the field but is independent of t . One thing that makes the use of phasors suitable is that a time derivative corresponds to a multiplication by $j\omega$,

$$\frac{\partial \mathbf{E}}{\partial t} = \text{Re}(j\omega \tilde{\mathbf{E}}(\mathbf{r})e^{j\omega t})$$

If the fields satisfy a linear time-dependent equation, then the corresponding phasors must satisfy a similar equation in which the time derivatives are replaced by a factor $j\omega$. All time-harmonic equations in the AC/DC Module are expressed as equations for the phasors. (The tilde is dropped from the variable denoting the phasor.)

The frequency domain formulation is only applicable for equations linear in the fields. In particular, it cannot be used with materials whose properties depend on the fields themselves (nonlinear materials). See [Effective Nonlinear Magnetic Constitutive Relations](#) for a formulation that approximates nonlinear magnetic constitutive relations in time-harmonic problems.



When analyzing the solution of a time-harmonic equation, it is important to remember that the field that has been calculated is a phasor and not a physical field.

For example, all plot functions visualize $\text{Re}(\tilde{\mathbf{E}}(\mathbf{r}))$ by default, which is \mathbf{E} at time $t = 0$. To obtain the solution at a given time, specify a phase factor in all results pages and in the corresponding functions.

Nonlinear Permanent Magnet Constitutive Relations

The BH nonlinear permanent magnet constitutive relation available in the Magnetic Fields and Magnetic Fields, No Currents is intended for easy modeling of self-demagnetization of soft permanent magnets, for example AlNiCo. It uses a nonlinear BH-relation that is isotropic around a point in \mathbf{H} space that is shifted by the coercive field \mathbf{H}_c . The shifted B-H and H-B curves that are specified in the associated material node are thus supplied in the first quadrant, that is shifted by \mathbf{H}_c with respect to the uniaxial curve. The **AC/DC** database in the **Add Material** window contains an

example material, **Nonlinear Permanent Magnet** to be used with this constitutive relation. It is a generic/approximate representation of AlNiCo 5.

Effective Nonlinear Magnetic Constitutive Relations

The effective constitutive relations can be used to approximate the behavior of a nonlinear magnetic material, such as a saturable material, in a (linear) Frequency Domain study.

The approach consists in replacing the nonlinear material with an inhomogeneous linear material — a material described by a magnetic permeability constant in time but which can be space dependent. The local magnetic permeability is chosen using an approximation criterion, such as, for example, that the cycle-average energy stored must be equal to the nonlinear case. As a consequence, the permeability may depend on the amplitude of the magnetic field and the nonlinear solver is invoked during the solution.

The formulation still applies the assumption of harmonic time dependency of the fields (which are still described as phasors): the fields still oscillate at the given frequency; higher-order harmonic effects, or other similar effects due to the nonlinearity, are not accounted for.

Using this constitutive relation provides a better approximation of the behavior of a nonlinear material in the frequency domain than linearizing the material properties, still avoiding the computational cost of a full transient analysis.

The application Effective Nonlinear Magnetic Curves Calculator in the AC/DC Module Application Library can be used to compute the effective B-H or H-B curve for a material, starting from its B-H or H-B curve.



Effective Nonlinear Magnetic Curves Calculator: Application Library
path **ACDC_Module/Applications/effective_nonlinear_magnetic_curves**

The Jiles-Atherton Hysteresis Model

Magnetic hysteresis originates from the alignment of electron spins into magnetic domains and the reorganization of such domains under the influence of an externally applied magnetizing field. In the Jiles-Atherton model, for each domain there is a reversible rotation and an irreversible rotation, which corresponds to a reversible and irreversible magnetization. In a magnetic material without hysteresis losses, there is

only a reversible part of the magnetization, usually modeled with a relative permeability or with a reversible B-H curve. The Jiles-Atherton hysteresis model includes a nonlinear relationship between the change in magnetization \mathbf{M} and the change in the magnetizing field \mathbf{H} . The magnetic flux density \mathbf{B} follows from the relation.

$$\mathbf{B} = \mu_0(\mathbf{H} + \mathbf{M})$$

The Jiles-Atherton model is a phenomenological model based on several parameters. The version available in COMSOL Multiphysics is full vectorial and anisotropic (see [Ref. 4](#) and [Ref. 5](#)), based upon the following five parameters:

- Magnetization reversibility: c_r
- Saturation magnetization: \mathbf{M}_s
- Domain wall density: \mathbf{a}
- Pinning loss: \mathbf{k}_p
- Inter-domain coupling: α

These quantities are second-order tensors, something that is not reflected by the equation notation here and in the graphical user interface.

The inter-domain coupling parameter is used for defining the effective magnetic field \mathbf{H}_e , which is the field that is assumed to affect the magnetic moments on a microscopical level:

$$\mathbf{H}_e = \mathbf{H} + \alpha \cdot \mathbf{M}$$

The saturation magnetization and domain wall density determine the anhysteretic part of the material behavior, which in this implementation follows the Langevin function,

$$L(x) = \coth(x) - 1/x$$

through the formula for anhysteretic magnetization \mathbf{M}_{an} :

$$\mathbf{M}_{an} = \mathbf{M}_s \cdot L(\mathbf{a}^{-1} \cdot \mathbf{H}_e) \frac{\mathbf{H}_e}{|\mathbf{H}_e|}$$

\mathbf{M}_s and \mathbf{a} enter the expression with the nonlinear Langevin function and consistent with [4], they are available as diagonal matrices. The use of the Langevin function should be interpreted as applied component wise.

The magnetization reversibility, c_r , affects the degree of anhysteretic versus hysteretic behavior. If it is set to unity, the model is purely anhysteretic.

The remaining parameter, k_p , controls the pinning and hysteresis of the magnetic moments.

Given the parameters above, the key equation in the Jiles-Atherton model determines the change in the total magnetization \mathbf{M} caused by a change in the effective magnetic field as:

$$d\mathbf{M} = \max(\chi \cdot d\mathbf{H}_e, 0) \frac{\chi}{|\chi|} + c_r d\mathbf{M}_{an}$$

where the auxiliary vector χ is defined as:

$$\chi = k_p^{-1} \cdot (\mathbf{M}_{an} - \mathbf{M})$$

The Jiles-Atherton hysteresis model is mainly suitable for time-dependent studies, but it also supports stationary parametric simulation. The latter is especially useful if the material is starting from a magnetized configuration that is not the solution of a previous transient study. In the graphical user interface, it is possible to select the initial value of magnetization, in which case the initial magnetic field is set accordingly.

It is implemented for the following physics interfaces: Magnetic Fields (based on vector potential); Magnetic Fields, No Currents (based on scalar potential); and Rotating Machinery, Magnetic (mixed vector and scalar potentials).

The internal state variables are discretized directly in the Gauss points, and an auxiliary variable is added to the same domain also for aiding support to simulations with moving domains.

The order of Gauss point discretization can be selected in the **Discretization** section under the **Magnetic Field** section. For the Gauss point discretization order, the default is **Automatic**. This default sets the Gauss points discretization order depending on the order of the parent physics. If the parent physics variable has order n , the Gauss point order is $2*(n-1)$. It is good practice to test that the results do not change significantly when using a Gauss point discretization of order $2*n$ since a good discretization order

depends on the kind of magnetic potential, mesh element shape, and space dimension, rather than the pure mesh size. For an example, see.



Vector Hysteresis Modeling: Application Library path **ACDC_Module/Other_Industrial_Applications/vector_hysteresis_modeling**

References for Electromagnetic Theory

1. D.K. Cheng, *Field and Wave Electromagnetics*, Addison-Wesley, Reading, Massachusetts, 1989.
2. J. Jin, *The Finite Element Method in Electromagnetics*, John Wiley & Sons, New York, 1993.
3. B.D. Popovic, *Introductory Engineering Electromagnetics*, Addison-Wesley, Reading, Massachusetts, 1971.
4. A.J. Bergqvist, “A Simple Vector Generalization of the Jiles-Atherton Model of Hysteresis,” *IEEE Transactions on Magnetics*, vol. 32, no. 5, pp. 4213–4215, 1996.
5. J. P. A. Bastos and N. Sadowski, *Magnetic Materials and 3D Finite Element Modeling*, CRC Press 2014.

Electromagnetic Forces

There are several ways to compute electromagnetic forces in COMSOL Multiphysics®. In the most general case, the calculation of electromagnetic forces involves the computation of volume forces acting on a body, and of surface forces originating from jumps in the electromagnetic fields on the boundaries. The volume and surface forces are derived from a general stress tensor that includes electromagnetic terms.

The derivation of the expressions for the electromagnetic stress tensor utilizes thermodynamic potential (energy) principles (Ref. 1 and Ref. 3). The distribution of electromagnetic forces in a system depends on the material. Accordingly, the techniques and expressions used when calculating electromagnetic forces are different for different types of materials.

Another technique for calculating forces using the method of virtual work is described in the section [Electromagnetic Energy, Coenergy and Virtual Work](#).

In this section:

- [Overview of Forces in Continuum Mechanics](#)
- [Forces on an Elastic Solid Surrounded by Vacuum or Air](#)
- [Torque](#)
- [Forces in Stationary Fields](#)
- [Forces in a Moving Body](#)
- [Electromagnetic Energy, Coenergy and Virtual Work](#)

Overview of Forces in Continuum Mechanics

Cauchy's equation of continuum mechanics reads

$$\rho \frac{d^2 \mathbf{r}}{dt^2} = \nabla \cdot \mathbf{T} + \mathbf{f}_{\text{ext}}$$

where ρ is the density, \mathbf{r} denotes the coordinates of a material point, \mathbf{T} is the stress tensor, and \mathbf{f}_{ext} is an external volume force such as gravity ($\mathbf{f}_{\text{ext}} = \rho \mathbf{g}$). This is the equation solved in the structural mechanics interfaces for the special case of a linear elastic material, neglecting the electromagnetic contributions.

In the stationary case there is no acceleration, and the equation representing the force balance is

$$\mathbf{0} = \nabla \cdot \mathbf{T} + \mathbf{f}_{\text{ext}}$$

The stress tensor must be continuous across a stationary boundary between two materials. This corresponds to the equation

$$\mathbf{n}_1(T_2 - T_1) = \mathbf{0}$$

where T_1 and T_2 represent the stress tensor in Materials 1 and 2, respectively, and \mathbf{n}_1 is the normal pointing out from the domain containing Material 1. This relation gives rise to a surface force acting on the boundary between Material 1 and 2.

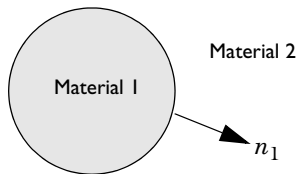

In certain cases, the stress tensor T can be divided into one part that depends on the electromagnetic field quantities and one part that is the mechanical stress tensor,

$$T = T_{\text{EM}} + \sigma_{\text{M}}$$

For the special case of an elastic body, the mechanical stress tensor is proportional only to the strain and the temperature gradient. The exact nature of this split of the stress tensor into an electromagnetic and a mechanical part depends on the material model, if it can be made at all.



For more information on the mechanical stress tensor for elastic materials, see the documentation for the interfaces. For example, [The Solid Mechanics Interface](#) in the *COMSOL Multiphysics Reference Manual*.

It is sometimes convenient to use a volume force instead of the stress tensor. This force is obtained from the relation

$$\mathbf{f}_{\text{em}} = \nabla \cdot T_{\text{EM}}$$

This changes the force balance equation to

$$\mathbf{0} = \nabla \cdot \sigma_{\text{M}} + \mathbf{f}_{\text{em}} + \mathbf{f}_{\text{ext}}$$

or, as stated in the structural mechanics interfaces,

$$-\nabla \cdot \boldsymbol{\sigma}_M = \mathbf{f} \quad \text{where} \quad \mathbf{f} = \mathbf{f}_{\text{em}} + \mathbf{f}_{\text{ext}}$$

Forces on an Elastic Solid Surrounded by Vacuum or Air

Consider a solid (Material 1) surrounded by vacuum (Material 2). It is natural to associate the surface force on the boundary between the materials with the solid. In many applications air can be approximated by vacuum.

In practice, the equation for the force balance also needs to include an external boundary force \mathbf{g}_{ext} . It is nonzero on those parts of the boundary where it is necessary to compensate for the contributions to the stress tensor that you are not interested in or do not have enough information on. These contributions come from the influence of the adjacent domains. By approximating the surroundings by vacuum or air, the influence of these boundaries and their adjacent domains (that are not part of our model) on the electromagnetic fields are neglected.

On the boundary, the following equations apply:

$$\begin{aligned} \mathbf{n}_1(T_2 - T_1) &= \mathbf{0} \\ \mathbf{n}_1 \tilde{T}_2 &= \mathbf{n}_1 T_2 + \mathbf{g}_{\text{ext}} \end{aligned}$$

The external boundary force \mathbf{g}_{ext} can represent the reaction force from another body that the solid is attached to.

The equations for the balance of forces on the solid now become

$$\begin{aligned} \nabla \cdot T_1 + \mathbf{f}_{\text{ext}} &= \mathbf{0} \\ \mathbf{n}_1(T_2 - T_1) + \mathbf{g}_{\text{ext}} &= \mathbf{0} \end{aligned}$$

For calculating the total force \mathbf{F} on the solid these equations need to be integrated over the entire solid and the solid/vacuum boundary

$$\int_{\Omega_1} (\nabla \cdot T_1 + \mathbf{f}_{\text{ext}}) dV + \oint_{\partial\Omega_1} (\mathbf{n}_1(T_2 - T_1) + \mathbf{g}_{\text{ext}}) dS = \mathbf{0}$$

According to the divergence theorem:

$$\int_{\Omega_1} \nabla \cdot T_1 dV - \oint_{\partial\Omega_1} \mathbf{n}_1 T_1 dS = \mathbf{0}$$

this means that the external force

$$\mathbf{F}_{\text{ext}} = \int_{\Omega_1} \mathbf{f}_{\text{ext}} dV + \oint_{\partial\Omega_1} \mathbf{g}_{\text{ext}} dS$$

is needed to balance the term for the boundary integral of the stress tensor in the surrounding vacuum

$$\mathbf{F} = \oint_{\partial\Omega_1} \mathbf{n}_1 T_2 dS$$

to keep the solid stationary. That is $\mathbf{F}_{\text{ext}} + \mathbf{F} = \mathbf{0}$. If the external forces are suddenly removed, the solid is no longer stationary, but \mathbf{F} causes the solid to begin to move with an initial acceleration according to

$$m\mathbf{a} = \int_{\Omega_1} \rho \frac{d^2 \mathbf{r}}{dt^2} dV = \mathbf{F}$$

where m is the total mass and \mathbf{a} is the acceleration of the solid.

To summarize, the total force, \mathbf{F} , is computed as a boundary integral of the stress tensor in vacuum on the outside of the solid. To obtain this result, the contribution from the air pressure gradient has been neglected. This is equivalent of assuming that $\nabla \cdot \mathbf{T}_2 = \mathbf{0}$. A more detailed treatment shows that the pressure gradient contributes with a lifting (buoyancy) force on the solid.

Torque

The torque in the case of [Forces on an Elastic Solid Surrounded by Vacuum or Air](#) is given by

$$\mathbf{M}_O = \oint_{\partial\Omega_1} (\mathbf{r} - \mathbf{r}_O) \times (\mathbf{n}_1 T_2) dS$$

where \mathbf{r}_O is a point on the axis of rotation. This follows from a derivation similar to the one made for forces.

Forces in Stationary Fields

The electromagnetic fields are stationary if

$$\frac{\partial \mathbf{B}}{\partial t} = \mathbf{0}$$

$$\frac{\partial \mathbf{D}}{\partial t} = \mathbf{0}$$

that is, if the fields vary so slowly that the contributions from induced currents and displacement currents can be neglected.

Also assume that the objects modeled are not moving $\mathbf{v} = \mathbf{0}$ so that there is no contributions from Lorentz forces. These are treated later on.

THE ELECTROMAGNETIC STRESS TENSOR



To apply the stress tensor in air to calculate the total force and torque on a magnetizable rod close to a permanent magnet, see *Permanent Magnet*: Application Library path **ACDC_Module/Magnetostatics/permanent_magnet**.

The expressions for the stress tensor in a general electromagnetic context stems from a fusion of material theory, thermodynamics, continuum mechanics, and electromagnetic field theory. With the introduction of thermodynamic potentials for mechanical, thermal, and electromagnetic effects, explicit expressions for the stress tensor can be derived in a convenient way by forming the formal derivatives with respect to the different physical fields (Ref. 1 and Ref. 3). Alternative derivations can be made for a vacuum (Ref. 4) but these cannot easily be generalized to polarized and magnetized materials.

Air and Vacuum

For air, the stress tensor is

$$T_2 = -pI - \left(\frac{\epsilon_0}{2} \mathbf{E} \cdot \mathbf{E} + \frac{1}{2\mu_0} \mathbf{B} \cdot \mathbf{B} \right) I + \epsilon_0 \mathbf{E} \mathbf{E}^T + \frac{1}{\mu_0} \mathbf{B} \mathbf{B}^T$$

where p is the air pressure, I is the identity 3-by-3 tensor (or matrix), and \mathbf{E} and \mathbf{B} are 3-by-1 vectors. In this expression of the stress tensor, air is considered to be nonpolarizable and nonmagnetizable. When air is approximated by vacuum, $p = 0$. This expression, with $p = 0$, of the stress tensor is also known as the Maxwell stress tensor.

Using the fact that, for air, $\mathbf{D} = \epsilon_0 \mathbf{E}$ and $\mathbf{B} = \mu_0 \mathbf{H}$ the expression for the stress tensor can be written as

$$T_2 = -pI - \left(\frac{1}{2}\mathbf{E} \cdot \mathbf{D} + \frac{1}{2}\mathbf{H} \cdot \mathbf{B}\right)I + \mathbf{E}\mathbf{D}^T + \mathbf{H}\mathbf{B}^T$$

The equation for the balance of forces becomes

$$\mathbf{0} = \nabla \cdot \left(-pI - \left(\frac{1}{2}\mathbf{E} \cdot \mathbf{D} + \frac{1}{2}\mathbf{H} \cdot \mathbf{B}\right)I + \mathbf{E}\mathbf{D}^T + \mathbf{H}\mathbf{B}^T\right) + \mathbf{f}_{\text{ext}}$$

Maxwell's equations in free space give that the contribution of the electromagnetic part of the stress tensor is zero, and the resulting expression is

$$\mathbf{0} = -\nabla p + \mathbf{f}_{\text{ext}}$$

Thus, using the same terminology as earlier, $\mathbf{f}_{\text{em}} = \mathbf{0}$ for air, with $\sigma_M = -pI$. In the derivation of the total force on an elastic solid surrounded by vacuum or air, the approximation $\nabla p = 0$ has been used.

When operating with the divergence operator on the stress tensor, the relation

$$\nabla \cdot \left(\mathbf{E}\mathbf{E}^T - \frac{1}{2}\mathbf{E} \cdot \mathbf{E}I\right) = \mathbf{E}(\nabla \cdot \mathbf{E}) - \mathbf{E} \times (\nabla \times \mathbf{E})$$

is useful (and similarly for \mathbf{B}). From the right-hand side it is clear (using Maxwell's equations) that this is zero for stationary fields in free space.

Consider again the case of a solid surrounded by air. To compute the total force, the projection of the stress tensor on the outside of the solid surface is needed,

$$\mathbf{n}_1 T_2 = -p\mathbf{n}_1 - \left(\frac{1}{2}\mathbf{E} \cdot \mathbf{D} + \frac{1}{2}\mathbf{H} \cdot \mathbf{B}\right)\mathbf{n}_1 + (\mathbf{n}_1 \cdot \mathbf{E})\mathbf{D}^T + (\mathbf{n}_1 \cdot \mathbf{H})\mathbf{B}^T$$

where \mathbf{n}_1 is the surface normal, a 1-by-3 vector, pointing out from the solid. This expression can be used directly in the boundary integral of the stress tensor for calculating the total force \mathbf{F} on the solid.

Elastic Pure Conductor



For an example of how to compute the total force on two parallel wires either by integrating the volume force or by integrating the stress tensor on the surrounding surface, see *Electromagnetic Forces on Parallel Current-Carrying Wires*: Application Library path **ACDC_Module/Verification_Examples/parallel_wires**.

A material that is nonpolarizable and nonmagnetizable ($\mathbf{P} = \mathbf{0}$ and $\mathbf{M} = \mathbf{0}$) is called a *pure conductor*. This is not necessarily equivalent to a perfect conductor, for which $\mathbf{E} = \mathbf{0}$, but merely a restriction on the dielectric and magnetic properties of the material. The stress tensor becomes identical to the one for air, except for $-pI$ being replaced by the purely mechanical stress tensor σ_M :

$$T_1 = \sigma_M - \left(\frac{1}{2} \mathbf{E} \cdot \mathbf{D} + \frac{1}{2} \mathbf{H} \cdot \mathbf{B} \right) I + \mathbf{E} \mathbf{D}^T + \mathbf{H} \mathbf{B}^T$$

where $\mathbf{D} = \epsilon_0 \mathbf{E}$ and $\mathbf{B} = \mu_0 \mathbf{H}$.

The situation is slightly different from the case of air because there can be currents and volume charges in the conductor. The current density is

$$\mathbf{J} = \nabla \times \mathbf{H} = \frac{1}{\mu_0} \nabla \times \mathbf{B}$$

and the volume charge density

$$\rho = \nabla \cdot \mathbf{D} = \epsilon_0 \nabla \cdot \mathbf{E}$$

The equation for the balance of forces now becomes

$$\mathbf{0} = \nabla \cdot \sigma_M + \rho \mathbf{E} + \mathbf{J} \times \mathbf{B} + \mathbf{f}_{\text{ext}}$$

and this means that

$$\mathbf{f}_{\text{em}} = \rho \mathbf{E} + \mathbf{J} \times \mathbf{B}$$

General Elastic Material

For an elastic solid, in the general case of a material that is both dielectric and magnetic (nonzero \mathbf{P} and \mathbf{M}), the stress tensor is given by the expression

$$T_1 = \sigma(\mathbf{E}, \mathbf{B}) - \left(\frac{\epsilon_0}{2} \mathbf{E} \cdot \mathbf{E} + \frac{1}{2\mu_0} \mathbf{B} \cdot \mathbf{B} - \mathbf{M} \cdot \mathbf{B} \right) I \\ + \epsilon_0 \mathbf{E} \mathbf{E}^T + \frac{1}{\mu_0} \mathbf{B} \mathbf{B}^T + \mathbf{E} \mathbf{P}^T - \mathbf{M} \mathbf{B}^T$$

where in $\sigma(\mathbf{E}, \mathbf{B})$ the dependence of \mathbf{E} and \mathbf{B} has not been separated out. Thus σ is not a purely mechanical stress tensor in this general case. Different material models give different appearances of $\sigma(\mathbf{E}, \mathbf{B})$. The electromagnetic contributions to $\sigma(\mathbf{E}, \mathbf{B})$ typically represent pyroelectric, pyromagnetic, piezoelectric, piezomagnetic, dielectric,

and magnetization effects. The expression for the stress tensor in vacuum, air, and pure conductors can be derived from this general expression by setting $\mathbf{M} = \mathbf{P} = \mathbf{0}$.

T_1 must be symmetric. The terms $\mathbf{E}\mathbf{P}^T$ and $-\mathbf{M}\mathbf{B}^T$ are symmetric in the case of a linear dielectric and magnetic material because

$$\begin{aligned}\mathbf{P} &= \varepsilon_0\chi_e\mathbf{E} \\ \mathbf{M} &= \chi_B\mathbf{B}\end{aligned}$$

Here, the magnetic susceptibility χ_B differs slightly from the classical χ_m . The other explicit terms are all symmetric, as is $\sigma(\mathbf{E}, \mathbf{B})$. In the general case this imposes constraints on the properties of $\sigma(\mathbf{E}, \mathbf{B})$. For a nonlinear material $\sigma(\mathbf{E}, \mathbf{B})$ might need to include terms such as $-\mathbf{E}\mathbf{P}^T$ or $+\mathbf{M}\mathbf{B}^T$ to compensate for asymmetric $\mathbf{E}\mathbf{P}^T$ or $-\mathbf{M}\mathbf{B}^T$.

To instantiate the stress tensor for the general elastic case, an explicit material model including the magnetization and polarization effects is needed. Such material models can easily be found for piezoelectric materials (Ref. 3).

Forces in a Moving Body

Calculating forces in moving objects is important, especially for electric motors and other moving electromagnetic devices. When performing the computations in a coordinate system that moves with the object, the electromagnetic fields are transformed. The most well-known relation for moving objects is the one for the electric field. The transformed quantity of the electric field is called the *electromotive intensity*.

FIELD TRANSFORMATIONS AND GALILEI INVARIANTS

Assume that the object modeled is moving with a constant velocity, $\mathbf{v} = \mathbf{v}_0$. The equations now take on a slightly different form that includes the Galilei invariant versions of the electromagnetic fields. The term Galilei invariant is used because they remain unchanged after a coordinate transformation of the type

$$\mathbf{r}' = \mathbf{r} + \mathbf{v}_0 t$$

In continuum mechanics, this transformation is commonly referred to as a Galilei transformation.

The Galilei invariant fields of interest are

$$\begin{aligned}
\tilde{\mathbf{E}} &= \mathbf{E} + \mathbf{v} \times \mathbf{B} && \text{(Electromotive intensity)} \\
\tilde{\mathbf{J}} &= \mathbf{J} - \rho \mathbf{v} && \text{(Free conduction current density)} \\
\tilde{\mathbf{P}} &= \frac{\partial \mathbf{P}}{\partial t} + \mathbf{v}(\nabla \cdot \mathbf{P}) - \nabla \times (\mathbf{v} \times \mathbf{P}) && \text{(Polarization flux derivative)} \\
\tilde{\mathbf{M}} &= \mathbf{M} + \mathbf{v} \times \mathbf{P} && \text{(Lorentz magnetization)} \\
\tilde{\mathbf{H}} &= \frac{\mathbf{B}}{\mu_0} - \varepsilon_0 \mathbf{v} \times \mathbf{E} - \tilde{\mathbf{M}} && \text{(Magnetomotive intensity)}
\end{aligned}$$

The electromotive intensity is the most important of these invariants. The Lorentz magnetization is significant only in materials for which neither the magnetization \mathbf{M} nor the polarization \mathbf{P} is negligible. Such materials are rare in practical applications. The same holds for the magnetization term of the magnetomotive intensity. Notice that the term $\varepsilon_0 \mathbf{v} \times \mathbf{E}$ is very small compared to \mathbf{B}/μ_0 except for cases when \mathbf{v} and \mathbf{E} are both very large. Thus in many practical cases this term can be neglected.

Air and Vacuum

The stress tensor in the surrounding air or vacuum on the outside of a moving object is

$$T_2 = -pI - \left(\frac{1}{2} \mathbf{E} \cdot \mathbf{D} + \frac{1}{2} \mathbf{H} \cdot \mathbf{B} \right) I + \mathbf{E} \mathbf{D}^T + \mathbf{H} \mathbf{B}^T + (\mathbf{D} \times \mathbf{B}) \mathbf{v}^T$$

There is an additional term in this expression compared to the stationary case.

Elastic Pure Conductor

The stress tensor in a moving elastic pure conductor is

$$T_1 = \sigma_M - \left(\frac{1}{2} \mathbf{E} \cdot \mathbf{D} + \frac{1}{2} \mathbf{H} \cdot \mathbf{B} \right) I + \mathbf{E} \mathbf{D}^T + \mathbf{H} \mathbf{B}^T + (\mathbf{D} \times \mathbf{B}) \mathbf{v}^T$$

where $\mathbf{D} = \varepsilon_0 \mathbf{E}$ and $\mathbf{B} = \mu_0 \mathbf{H}$.

To get the equation for the balance of forces the divergence of this expression needs to be computed. This requires an introduction of an extra term in Cauchy's equation corresponding to an additional electromagnetic contribution to the linear momentum. Cauchy's equation with this extra term is

$$\rho \frac{d^2 \mathbf{r}}{dt^2} + \mathbf{D} \times \mathbf{B} = \nabla \cdot T + \mathbf{f}_{\text{ext}}$$

The extra term is canceled out by the additional term in the stress tensor, and the final result is

$$\rho \frac{d^2 \mathbf{r}}{dt^2} = \nabla \cdot \boldsymbol{\sigma}_M + \rho \tilde{\mathbf{E}} + \tilde{\mathbf{J}} \times \mathbf{B} + \mathbf{f}_{\text{ext}}$$

For the case of no acceleration, with the explicit appearance of the transformed quantities,

$$\mathbf{0} = \nabla \cdot \boldsymbol{\sigma}_M + \rho(\mathbf{E} + \mathbf{v} \times \mathbf{B}) + (\mathbf{J} - \rho \mathbf{v}) \times \mathbf{B} + \mathbf{f}_{\text{ext}}$$

The terms containing $\mathbf{v} \times \mathbf{B}$ cancel out, which yields the following equation:

$$\mathbf{0} = \nabla \cdot \boldsymbol{\sigma}_M + \rho \mathbf{E} + \mathbf{J} \times \mathbf{B} + \mathbf{f}_{\text{ext}}$$

which is the same expression as for the stationary case.

General Elastic Material

The stress tensor for a moving general elastic material is

$$\begin{aligned} T_1 = & \sigma(\tilde{\mathbf{E}}, \mathbf{B}) - \left(\frac{\epsilon_0}{2} \mathbf{E} \cdot \mathbf{E} + \frac{1}{2\mu_0} \mathbf{B} \cdot \mathbf{B} - \tilde{\mathbf{M}} \cdot \mathbf{B} \right) I + \\ & + \epsilon_0 \mathbf{E} \mathbf{E}^T + \frac{1}{\mu_0} \mathbf{B} \mathbf{B}^T + \tilde{\mathbf{E}} \mathbf{P}^T - \tilde{\mathbf{M}} \mathbf{B}^T + \epsilon_0 (\mathbf{E} \times \mathbf{B}) \mathbf{v}^T \end{aligned}$$

The magnetization \mathbf{M} and the polarization \mathbf{P} occur explicitly in this expression.

To instantiate the stress tensor for the general elastic case a material model explicitly including the magnetization and polarization effects is needed.

Electromagnetic Energy, Coenergy and Virtual Work

Another technique to calculate forces is to derive the electromagnetic energy or coenergy of the system and calculate the force by studying the effect of a small displacement. This is known as the *method of virtual work* or the *principle of virtual displacement*.

The method of virtual work is used for the electric energy and magnetic energy separately for calculating the total electric or magnetic force as follows.

MAGNETIC ENERGY, COENERGY, FORCE, AND TORQUE

For nonlinear magnetic materials without hysteresis, the magnetic energy and coenergy densities are, respectively,

$$dW_m = \int_0^{\mathbf{B}} \mathbf{H} \cdot d\mathbf{B}$$

$$dW'_m = \int_0^{\mathbf{H}} \mathbf{B} \cdot d\mathbf{H}$$

Knowing either of these, the other can be computed through the relation

$$dW_m = \mathbf{H} \cdot \mathbf{B} - dW'_m$$

For the case of linear materials, the magnetic energy and coenergy densities are equal.

The method of virtual work utilizes that, under *constant magnetic flux* conditions (Ref. 5), the total magnetic force on a system is computed as

$$\mathbf{F}_\Phi = -\nabla W_m$$

If the system is constrained to rotate about an axis the torque is computed as

$$T_\Phi = \frac{\partial W_m}{\partial \phi}$$

where ϕ is the rotational angle about the axis.

Under the condition of *constant currents and linear materials*, the total force and torque can be computed in the same way but with opposite signs,

$$\mathbf{F}_I = \nabla W_m$$

$$T_I = \frac{\partial W_m}{\partial \phi}$$

Under the condition of *constant currents and nonlinear materials*, the total force and torque must be computed from the magnetic coenergy and with opposite signs,

$$\mathbf{F}_I = \nabla W'_m$$

$$T_I = \frac{\partial W'_m}{\partial \phi}$$

ELECTRIC ENERGY, COENERGY, FORCE, AND TORQUE

For nonlinear dielectric materials without hysteresis, the electric energy and coenergy densities are, respectively,

$$dW_e = \int_0^{\mathbf{D}} \mathbf{E} \cdot d\mathbf{D}'$$
$$dW_e = \int_0^{\mathbf{E}} \mathbf{D} \cdot d\mathbf{E}'$$

Knowing either of these, the other one can be computed through the relation

$$dW_e = \mathbf{E} \cdot \mathbf{D} - dW_e$$

For the case of linear materials, the electric energy and coenergy densities are equal.

Under the condition of *constant charges*, the total electric force and torque on a system are computed as

$$\mathbf{F}_Q = -\nabla W_e$$
$$T_Q = -\frac{\partial W_e}{\partial \phi}$$

Under the condition of *constant potentials and linear materials*, the total electric force and torque on a system can be computed as

$$\mathbf{F}_V = \nabla W_e$$
$$T_V = \frac{\partial W_e}{\partial \phi}$$

Under the condition of *constant potentials and nonlinear materials*, the total electric force and torque on a system must be computed from the electric coenergy as

$$\mathbf{F}_V = \nabla W_e$$
$$T_V = \frac{\partial W_e}{\partial \phi}$$



The method of virtual work can be employed by using the features for deformed mesh and sensitivity analysis in COMSOL Multiphysics.

See [Deformed Geometry and Moving Mesh](#) and [Sensitivity Analysis](#) in the *COMSOL Multiphysics Reference Manual*.

Electromagnetic Quantities

The table below shows the symbol and SI unit for most of the physical quantities that are included with the AC/DC Module.

TABLE 2-1: ELECTROMAGNETIC QUANTITIES

QUANTITY	SYMBOL	SI UNIT	ABBREVIATION
Angular frequency	ω	radian/second	rad/s
Attenuation constant	α	meter ⁻¹	m ⁻¹
Capacitance	C	farad	F
Charge	q	coulomb	C
Charge density (surface)	ρ_s	coulomb/meter ²	C/m ²
Charge density (volume)	ρ	coulomb/meter ³	C/m ³
Current	I	ampere	A
Current density (surface)	\mathbf{J}_s	ampere/meter	A/m
Current density (volume)	\mathbf{J}	ampere/meter ²	A/m ²
Electric displacement	\mathbf{D}	coulomb/meter ²	C/m ²
Electric field	\mathbf{E}	volt/meter	V/m
Electric potential	V	volt	V
Electric susceptibility	χ_e	(dimensionless)	-
Electrical conductivity	σ	siemens/meter	S/m
Energy density	W	joule/meter ³	J/m ³
Force	\mathbf{F}	newton	N
Frequency	ν	hertz	Hz
Imaginary unit	j, i	(dimensionless)	-
Impedance	Z, η	ohm	Ω
Inductance	L	henry	H
Magnetic current density (surface)	\mathbf{J}_{ms}	volt/meter	-
Magnetic field	\mathbf{H}	ampere/meter	A/m
Magnetic flux	Φ	weber	Wb
Magnetic flux density	\mathbf{B}	tesla	T
Magnetic potential (scalar)	V_m	ampere	A
Magnetic potential (vector)	\mathbf{A}	weber/meter	Wb/m

TABLE 2-1: ELECTROMAGNETIC QUANTITIES

QUANTITY	SYMBOL	SI UNIT	ABBREVIATION
Magnetic susceptibility	χ_m	(dimensionless)	-
Magnetization	M	ampere/meter	A/m
Permeability	μ	henry/meter	H/m
Permittivity	ϵ	farad/meter	F/m
Polarization	P	coulomb/meter ²	C/m ²
Poynting vector	S	watt/meter ²	W/m ²
Propagation constant	β	radian/meter	rad/m
Reactance	X	ohm	Ω
Relative permeability	μ_r	(dimensionless)	-
Relative permittivity	ϵ_r	(dimensionless)	-
Resistance	R	ohm	W
Resistive loss	Q	watt/meter ³	W/m ³
Torque	T	newton-meter	N·m
Velocity	v	meter/second	m/s
Wavelength	λ	meter	m
Wave number	k	radian/meter	rad/m

References for the AC/DC Interfaces

1. A. Kovetz, *The Principles of Electromagnetic Theory*, Cambridge University Press, 1990.
2. Jianming Jin, *The Finite Element Method in Electromagnetics*, 2nd ed., Wiley-IEEE Press, 2002.
3. O. Wilson, *Introduction to Theory and Design of Sonar Transducers*, Peninsula Publishing, 1988.
4. R.K. Wangsness, *Electromagnetic Fields*, 2nd ed., John Wiley & Sons, 1986.
5. D.K. Cheng, *Field and Wave Electromagnetics*, 2nd ed., Addison-Wesley, 1991.
6. O.C. Zienkiewicz, C. Emson, and P. Bettess, "A Novel Boundary Infinite Element," *International Journal for Numerical Methods in Engineering*, vol. 19, no. 3, pp. 393–404, 1983.

Modeling with the AC/DC Module

The goal of this chapter is to familiarize you with the modeling procedure in the AC/DC Module. Because this module is fully integrated with COMSOL Multiphysics[®], the modeling process is similar.

In this chapter:

- [Preparing for Modeling](#)
- [Force and Torque Computations](#)
- [Coil Features](#)
- [Lumped Parameters](#)
- [Lumped Ports with Voltage Input](#)
- [S-Parameters and Ports](#)
- [Connecting to Electrical Circuits](#)
- [SPICE Import and Export](#)

Preparing for Modeling

This section is intended a guide you through the selection process among the interfaces in the AC/DC Module and does not contain detailed physics interface descriptions. Several topics about the art of modeling are covered here that might not be in ordinary textbooks on electromagnetic theory. This section discusses these topics:

- [What Problems Can You Solve?](#) — Can I use the quasi-static physics interfaces or do I need wave propagation?
- [Selecting the Space Dimension for the Model Geometry](#) — Is a 2D, 3D, or axisymmetric geometry best for my model?
- [Simplifying the Geometry Using Boundary Conditions](#) — When do I need to resolve the thickness of thin shells?
- [Applying Electromagnetic Sources](#) — What sources can I use to excite the fields?
- [Selecting a Study Type](#) — Is my problem suited for time-dependent or time-harmonic (frequency domain) formulations?
- [2D Field Variables](#)
- [About the AC/DC and Nonlinear Magnetic Material Databases](#)
- [Meshing and Solving](#) — What issues might arise with respect to meshing and solving?



For general guidelines for effective modeling see [Building a COMSOL Multiphysics Model](#) in the *COMSOL Multiphysics Reference Manual*.

GENERAL TIPS

These general tips about modeling help you to decide what to include in a simulation and what can be done to minimize the size of a problem. Before starting to model, try to answer the following questions first:

- What is the purpose of the model?
- What information do you want to extract from the model?



Models never capture all the details of reality.

Increasing the complexity of a model to make it more accurate usually makes it more expensive to simulate. A complex model is also more difficult to manage and interpret than a simple one.



It can be more accurate and efficient to use several simple models instead of a single, complex one.

What Problems Can You Solve?

The AC/DC Module interfaces handle static, time-dependent, and time-harmonic problems. The time-dependent and time-harmonic formulations use a quasi-static approximation. See [Table 1-1 in Overview of the User's Guide](#) for a list of the preset study types available by physics interface.

One major difference between quasi-static and high-frequency modeling is that the formulations depend on the *electrical size* of the structure. This dimensionless measure is the ratio between the largest distance between two points in the structure divided by the wavelength of the electromagnetic fields.

The quasi-static physics interfaces in this module are suitable for simulations of structures with an electrical size in the range up to 1/10. The physical assumption of these situations is that the currents and charges generating the electromagnetic fields vary so slowly in time that the electromagnetic fields are practically the same at every instant as if they had been generated by stationary sources.

When the variations in time of the sources of the electromagnetic fields are more rapid, it is necessary to solve the full Maxwell equations for high-frequency electromagnetic waves. They are appropriate for structures of electrical size 1/100 and larger. Thus, an

overlapping range exists where both the quasi-static and the full Maxwell formulations can be used.



Physics interfaces for high-frequency electromagnetic waves are available in the RF Module.

Independent of the structure size, the AC/DC Module accommodates any case of nonlinear, inhomogeneous, or anisotropic media. It also handles materials with properties that vary as a function of time as well as frequency-dispersive materials. Examples of applications that successfully simulate with this module include electric motors, generators, permanent magnets, induction heating devices, and dielectric heating. For a more detailed description of some of these applications, refer to the Application Libraries included with the module.

Selecting the Space Dimension for the Model Geometry

Most of the problems solved with COMSOL Multiphysics are three-dimensional (3D) in the real world. In many cases, it is sufficient to solve a two-dimensional (2D) problem that is close, or equivalent, to the real problem.



It is good practice to start a modeling project by building one or several 2D models before going to a 3D model.

This is because 2D models are easier to modify and solve much faster. Thus, modeling mistakes are much easier to find when working in 2D. Once the 2D model is verified, you are in a much better position to build a 3D model.

2D PROBLEMS



The following is a guide through some of the common approximations made for 2D problems. Remember that modeling in 2D usually represents some 3D geometry under the assumption that nothing changes in the third dimension.

Cartesian Coordinates

In this case you view a cross section in the xy -plane of the actual 3D geometry. The geometry is mathematically extended to infinity in both directions along the z -axis,

assuming no variation along that axis. All the total flows in and out of boundaries are per unit length along the z -axis. A simplified way of looking at this is to assume that the geometry is extruded one unit length from the cross section along the z -axis. The total flow out of each boundary is then from the face created by the extruded boundary (a boundary in 2D is a line).

There are usually two approaches that lead to a 2D cross-section view of a problem:

- When it is known that there is no variation of the solution in one particular dimension.
- When there is a problem where the influence of the finite extension in the third dimension can be neglected.



Electromagnetic Forces on Parallel Current-Carrying Wires:

Application Library path **ACDC_Module/Verification_Examples/parallel_wires**

The geometry has a finite width but the model neglects the (end) effects from the faces parallel to the cross section because the strongest forces are between the perpendicular faces (those seen as lines in the cross section).

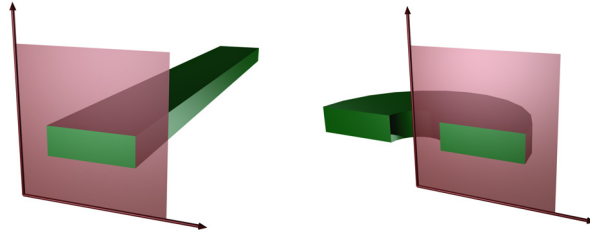

Figure 3-1: The cross sections and their real geometry for Cartesian coordinates and cylindrical coordinates (axial symmetry).

Axial Symmetry (Cylindrical Coordinates)



If the 3D geometry can be constructed by revolving a cross section about an axis, and no variations in any variable occur when going around the axis of revolution, an axisymmetric physics interface can be used.

The spatial coordinates are called r and z , where r is the radius. The flow at the boundaries is given per unit length along the third dimension. Because this dimension

is a revolution, you have to multiply all flows with αr , where α is the revolution angle (for example, 2π for a full turn).

3D PROBLEMS



This section discusses issues that should be addressed before starting to implement a 3D model.

Although COMSOL Multiphysics fully supports arbitrary 3D geometries, it is important to simplify the problem. This is because 3D problems easily get large and require more computer power, memory, and time to solve. The extra time spent on simplifying a problem is probably well spent when solving it.

Is it possible to solve the problem in 2D? Given that the necessary approximations are small, the solution is more accurate in 2D because a much denser mesh can be used. See [2D Problems](#) if this is applicable.

Do you know the dependence in one direction so it can be replaced by an analytical function? You can use this approach either to convert 3D to 2D or to convert a layer to a boundary condition (see [Simplifying the Geometry Using Boundary Conditions](#)).

Are there symmetries in the geometry and model? Many problems have planes where the solution on either side of the plane looks the same. A good way to check this is to flip the geometry around the plane, for example, by turning it upside down around the horizontal plane. You can then remove the geometry below the plane if you do not see any differences between the two cases regarding geometry, materials, and sources. Boundaries created by the cross section between the geometry and this plane need a symmetry boundary condition, which is available in all 3D physics interfaces.



Eddy Currents: Application Library path **ACDC_Module/Inductive_Devices_and_Coils/eddy_currents**

Simplifying the Geometry Using Boundary Conditions

An important technique to minimize the problem of size is to use efficient boundary conditions. Truncating the geometry without introducing large errors is one of the great challenges in modeling. Following are some ideas of how to do this in both 2D and 3D problems.

Does the solution only undergo small changes? When a model extends to infinity, it might have regions where the solution only undergoes small changes. This problem is addressed in two related steps. First, truncate the geometry in a suitable position. Second, apply a suitable boundary condition there. For static and quasi-static models, it is often possible to assume zero fields at the open boundary, provided that this is at a sufficient distance away from the sources.

Can you replace the thin layers with boundary conditions? There are several types of boundary conditions in COMSOL Multiphysics suitable for such replacements. You can, for example, replace materials with high conductivity with the shielding boundary condition, which assumes a constant potential through the thickness of the layer. If you have a magnetic material with a high relative permeability, you can also model it using the shielding boundary condition.



One-Sided Magnet and Plate: Application Library path **ACDC_Module/**
Magnetostatics/one_sided_magnet

Use boundary conditions for known solutions. A body with a high conductivity at high frequency has the current density confined to a thin region beneath the surface of the wire. You can often replace the current in the body by either a surface current boundary condition or an impedance boundary condition.



Eddy Currents: Application Library path **ACDC_Module/**
Inductive_Devices_and_Coils/eddy_currents

Applying Electromagnetic Sources

Electromagnetic sources can be applied in many different ways. The typical options are volume sources, boundary sources, line sources, and point sources, where point sources in 2D formulations are equivalent to line sources in 3D formulations. The way sources are imposed can have an impact on what quantities can be computed from the model. For example, a point source in an electrostatics model represents a singularity, and the electric potential does not have a finite value at the position of the source.

In a COMSOL Multiphysics model, a point source has a finite but mesh-dependent potential value. Thus, it does not make sense to compute a point-to-point capacitance, because this is defined as the ratio of charge to voltage and for a point charge, the potential is not well defined. In general, using volume or boundary sources is more

flexible than using line or point sources but the meshing of the source domains becomes more expensive.

Selecting a Study Type

When variations in time are present there are two main approaches to how to represent the time dependence. The most straightforward is to solve the problem in the time domain by calculating the changes in the solution for each time step. This approach can be time consuming if small time steps are necessary for the desired accuracy. It is necessary to use this approach when the inputs are transients like turn-on and turn-off sequences.

An efficient simplification is to assume that all variations in time occur as sinusoidal signals. Then the problem is time-harmonic and it can be formulated as a stationary problem in the frequency domain with complex-valued solutions. The complex value represents both the amplitude and the phase of the field, while the frequency is specified as a predefined scalar input or for frequency sweeps, provided as a solver parameter. This approach is useful because, combined with Fourier analysis, it applies to all periodic signals with the exception of nonlinear problems. Examples of typical frequency domain simulations are quasi-static problems where the input variables are sinusoidal signals.

For nonlinear problems, use a frequency domain study after a linearization of the problem, which assumes that the distortion of the sinusoidal signal is small.

Specify a Time Dependent study when you think that the nonlinear influence is very strong, or if you are interested in the harmonic distortion of a sinusoidal signal. It might also be more efficient to use a Time Dependent study if there is a periodic input with many harmonics, like a square-shaped signal.

There are some special predefined study types for the Induction Heating interface. This physics interface is based on the assumption that the magnetic cycle time is short compared to the thermal time scale (adiabatic assumption). Thus, it is associated with four predefined study sequences.

- Frequency-Stationary
 - Time-harmonic magnetic fields
 - Stationary heat transfer

- Frequency-Transient
 - Time-harmonic magnetic fields
 - Transient heat transfer
- Frequency-Stationary, One-Way Coupled, Electromagnetic Heating
 - Time-harmonic magnetic fields
 - Stationary heat transfer
- Frequency-Transient, One-Way Coupled, Electromagnetic Heating
 - Time-harmonic magnetic fields
 - Transient heat transfer

The difference between the first two and the last two study sequences is that in the Frequency-Stationary and the Frequency-Transient studies, the coupling between the electromagnetic and the heat transfer problem is bidirectional. The electromagnetic problem defines a heat source for the heat transfer problem and the material properties in the electromagnetic problem are temperature dependent. For the Frequency-Stationary, One-Way Coupled, Electromagnetic Heating and Frequency-Transient, One-Way Coupled, Electromagnetic Heating study sequences, it is assumed that the material properties for the electromagnetic problem is temperature independent, so a Frequency Domain study is added for the electromagnetic problem followed by a Stationary or Time Dependent study for the heat transfer problem.



AC/DC Module Study Availability

2D Field Variables

When solving for a vector field in 2D, the physics interface has three options: to solve for the out-of-plane vector, the in-plane vector, or the three-component vector. Depending on the choice, the available source specification options on the domain, boundary, edge, and point levels change accordingly.



For detailed information about [Materials](#) including the [AC/DC Materials Database](#) and [Nonlinear Magnetic Materials Database](#), see the *COMSOL Multiphysics Reference Manual*.

Nonlinear magnetic materials are generally provided as interpolation functions for the magnetization curve without hysteresis effects. In the main equation nodes, that is in any of the nodes; **Ampère's Law**, **Ampère's Law and Current Conservation**, **Faraday's Law**, or **Magnetic Flux Conservation** and, depending on which of the AC/DC interfaces is being used, one needs to select the magnetic field constitutive relation **B-H curve** or **H-B curve**.



For an example of the AC/DC materials database and of using nonlinear magnetic materials in general, see *Small-Signal Analysis of an Inductor*: Application Library path **ACDC_Module/Inductive_Devices_and_Coils/small_signal_analysis_of_inductor**

Meshing and Solving

MESH RESOLUTION

The finite element method approximates the solution within each element, using some elementary shape function that can be constant, linear, or of higher order. Depending on the element order in the model, a finer or coarser mesh is required to resolve the solution. In general, there are three problem-dependent factors that determine the necessary mesh resolution:

Is the variation in the solution due to geometrical factors? The mesh generator automatically generates a finer mesh where there is a lot of fine geometrical details. Try to remove such details if they do not influence the solution because they produce a lot of unnecessary mesh elements.

Is the skin effect or the field variation due to losses? It is easy to estimate the skin depth from the conductivity, permeability, and frequency. You need at least two linear elements per skin depth to capture the variation of the fields. If you do not study the skin depth, you can replace regions with a small skin depth with a boundary condition, thereby saving elements.

What is the wavelength? To resolve a wave properly, it is necessary to use about 10 linear (or 5 2nd-order) elements per wavelength. Keep in mind that the wavelength might be shorter in a dielectric medium.

SELECTING A SOLVER

In most cases the solver that COMSOL Multiphysics suggests can be used. The choice of solver is optimized for the typical case for each physics interface and study type in the AC/DC Module. However, in special cases the solver settings might need fine tuning. This is especially important for 3D problems because they use a large amount of memory. For large 3D problems, a 64-bit platform might be required.



In the *COMSOL Multiphysics Reference Manual*:

- [Meshing](#)
 - [Studies and Solvers](#)
-

Force and Torque Computations

In this section:

- [Calculating Electromagnetic Forces and Torques](#)
- [Model Examples — Electromagnetic Forces](#)

Calculating Electromagnetic Forces and Torques

Two methods are available to calculate electromagnetic forces and torques:

- The most general method is to use the Maxwell stress tensor.
- Another method that works for the special case of computation of magnetic forces on nonmagnetic, current-carrying domains uses a predefined physics interface variable for the Lorentz force distribution in a magnetic flux density **B**.

MAXWELL STRESS TENSOR

Force and torque calculations using Maxwell's stress tensor are available in the electrostatics, electric currents, magnetic fields, and magnetic and electric fields interfaces. In electrostatics and electric currents, the force is calculated by integrating

$$\mathbf{n}_1 T_2 = -\frac{1}{2} \mathbf{n}_1 (\mathbf{E} \cdot \mathbf{D}) + (\mathbf{n}_1 \cdot \mathbf{E}) \mathbf{D}^T \quad (3-1)$$

on the surface of the object that the force acts on.

In the Magnetic Fields interface, the expression

$$\mathbf{n}_1 T_2 = -\frac{1}{2} \mathbf{n}_1 (\mathbf{H} \cdot \mathbf{B}) + (\mathbf{n}_1 \cdot \mathbf{H}) \mathbf{B}^T$$

is integrated on the surface to obtain the force. In the Magnetic and Electric Fields interface, both expressions are included. **E** is the electric field, **D** the electric displacement, **H** the magnetic field, **B** the magnetic flux density, and **n**₁ the outward normal from the object. For a theoretical discussion about the stress tensor, see [Electromagnetic Forces](#).

LORENTZ FORCES

The *Lorentz force* is defined as $\mathbf{F} = \mathbf{J} \times \mathbf{B}$. The Lorentz force is very accurate for electromagnetic force calculations in electrically conducting domains. The Lorentz

force variables are available both in domains and on boundaries (in the case of surface currents).

CYCLE-AVERAGED QUANTITIES

In Frequency Domain studies, the formulas presented above can be used to compute the instantaneous force and torque by taking the real part of all the variables involved. It is often more interesting to compute the average of these quantities over a cycle to, for example, couple the electromagnetic forces to another physics. The cycle-averaged Maxwell's stress tensor (including both electric and magnetic forces) is computed as:

$$\mathbf{n}_1 T_{\text{av},2} = \frac{1}{2} \text{Re} \left(-\frac{1}{2} \mathbf{n}_1 (\mathbf{E}^* \cdot \mathbf{D}) + (\mathbf{n}_1 \cdot \mathbf{E}^*) \mathbf{D}^T - \frac{1}{2} \mathbf{n}_1 (\mathbf{H}^* \cdot \mathbf{B}) + (\mathbf{n}_1 \cdot \mathbf{H}^*) \mathbf{B}^T \right)$$

Model Examples — Electromagnetic Forces

There are a number of examples in the AC/DC Module Applications Libraries showing how to calculate electromagnetic forces in different situations.

The *Electromagnetic Forces on Parallel Current-Carrying Wires* model uses both Maxwell's stress tensor and the Lorentz force method to compute magnetic forces. It shows how to compute the total force on a device by integrating the volume force $\mathbf{J} \times \mathbf{B}$ —the most important method for calculating forces in current-carrying devices. For materials that can be described as pure conductors (see later on in this section) this method gives the exact distribution of forces inside a device. The quantity $\mathbf{J} \times \mathbf{B}$ is the Lorentz force and is available as a predefined variable on domains and boundaries. The model also illustrates how to compute the force by integrating the Maxwell stress tensor on boundaries.

The *Permanent Magnet* model demonstrates how to compute the total force on a magnetizable rod close to a permanent magnet by integrating the Maxwell stress tensor in the air on the outside of the rod. This is the most important method for accurately calculating the total force on magnetic devices for which the exact distribution of volume forces is not known. To retrieve the exact distribution of volume forces requires a material that describes the interactions of the magnetizations and strains. Such materials are not always available. Therefore you are often limited to compute the total force by integrating the stress tensor or using the method of virtual work.



None of these methods can be used to compute and visualize the force distribution inside a domain, only to compute the total force and torque in situations where the device is surrounded by a nonsolid medium (or when this is a good approximation).



- *Electromagnetic Forces on Parallel Current-Carrying Wires:* Application Library path **ACDC_Module/Verification_Examples/parallel_wires**
 - *Permanent Magnet:* Application Library path **ACDC_Module/Magnetostatics/permanent_magnet**
-

Coil Features

In this section:

- [About the Coil Features](#)
- [About the Coil Name](#)
- [Coil Excitation](#)
- [Coil Groups](#)
- [Lumped Parameter Calculations](#)
- [Using Coils in 3D Models](#)
- [Automatic Coil Geometry Analysis](#)
- [Accurate Coil Voltage Calculation](#)



- [The Magnetic Fields Interface](#)
 - [The Rotating Machinery, Magnetic Interface](#)
 - [The Magnetic and Electric Fields Interface](#)
-

About the Coil Features

The coil features can be used to simplify the set up of magnetostatics and low-frequency electromagnetic models. In many such applications, the magnetic field is generated by electric currents flowing in conductive materials (for example, cables, wires, coils, or solenoids). The coil features can be used to easily model these structures and to translate lumped quantities (currents and voltages) into distributed quantities (current densities and electric fields). This section describes the main [Coil](#) feature, which is available in [The Magnetic Fields Interface](#), [The Rotating Machinery, Magnetic Interface](#), and [The Magnetic and Electric Fields Interface](#).

The Coil is available both as a domain and as a boundary feature. The latter can be used to model flat coils for which the thickness is negligible compared to the other two dimensions.

The **Coil** feature supports two different **Conductor model** options, which differ by the physical system represented and the modeling details.

- The **Single conductor** option models a single, solid region of a conducting material (for example, metal) in which the current flows. The lumped voltage and current of the coil correspond, respectively, to the integral of the electric field along the coil length and to the integral of the current density on a cross section. Use this option in a domain feature to model a single wire with a nonnegligible cross section; in a boundary feature it can be used for a thin conductive layer whose thickness is negligible (for example, in frequency domain, it is small with respect to the skin depth).
- The **Homogenized multi-turn** option implements a homogenized model of a coil consisting of numerous tightly-wound conducting wires, separated by an electrical insulator. The computation of the voltage and current of the coil is performed in a similar way as for the **Single conductor** model, but it also takes into account parameters such as the number of wires and the cross-section area. Use this feature to model a coil containing a large number of wires without the need to model each wire individually. The boundary feature can be used when the wires are arranged in a thin region whose thickness is negligible. Note that capacitive coupling and skin effect are neglected in the homogenized model.



For 2D and 2D axisymmetric geometries, the current applied by a Coil is always in the out-of-plane direction. Thus capacitive (in-plane) coupling is neglected.

For 3D model geometries, the direction of the current flow is not easily determined. The coil domains have settings and subnodes to solve this problem. See [Using Coils in 3D Models](#) for more information.



Selecting unconnected geometrical entities with a Coil connects them in parallel.



For examples of a **Single conductor** Coil, see:

- *Inductive Heating of a Copper Cylinder*: Application Library path **ACDC_Module/Electromagnetic_Heating/inductive_heating**
- *Tutorial Example: Modeling a 3D Inductor* (described in detail in the *Intruction to the AC/DC Module* manual): Application Library path **ACDC_Module/Inductive_Devices_and_Coils/inductor_3d**.

For examples of a **Homogenized multi-turn** Coil see:

- *Magnetic Field of a Helmholtz Coil*: Application Library path **ACDC_Module/Inductive_Devices_and_Coils/helmholtz_coil**
- Inductor in an Amplifier Circuit*: Application Library path **ACDC_Module/Inductive_Devices_and_Coils/inductor_in_circuit**
-

WHAT MATERIAL TO USE FOR THE COIL?

The Coil domain feature is based on [Ampère's Law](#) and it requires material properties to set up the appropriate constitutive relations. The boundary feature also requires the electrical conductivity when the Single conductor model is used. What is the correct choice of materials for the Coil domains or boundaries?

- When using the **Single conductor** option, the coil models a solid conductive domain (typically a metal). The material properties of the metal (electric permitting, magnetic permeability, and electrical conductivity) should be used in this case.
- When using the **Homogenized multi-turn** option, the conduction current (induced current) is assumed to flow only in the wires. To prevent induced current density from flowing in the domain, the region's electrical conductivity σ is set to zero. The material used in the domain, only specifies the constitutive relations for the electric displacement field and the magnetic flux density. Therefore, choose or create a material that provides constitutive relations representative of the entire coil domain, not just of the material making up the metallic wires.

OTHER COIL FEATURES

Two coil features designed for special applications are available in the **Magnetic and Electric Fields** interface in 2D and 2D axisymmetric components:

- The **RLC Coil Group** feature, that models coils for which capacitive effects between coil turns and with other parts of the models are comparable with the inductive effects.
- The **Single-Turn Coil** feature, to introduce an externally applied current or voltage on domains where the **Ampère’s Law and Current Conservation** feature is active. This feature is contributing, that is, it simply adds an external current density to the domain model represented by **Ampère’s Law and Current Conservation**.

About the Coil Name

For all types of coil physics nodes, a coil name is entered to allow the identification of the feature and the variables it creates. By default, this is set to a unique number, but can be changed as long as it is unique between all the coil nodes in a model.

Coil Excitation

The current density flowing in the coil domain is computed from a lumped quantity that constitutes the coil excitation. The choice of this quantity can be done by setting the coil excitation parameter, while the value is specified in the associated text box. All the coil features can be excited either with *current excitation*, *voltage excitation* or, in certain cases, *power excitation*. The supplied value or expression is translated to a current density or electric field applied to the domain according to the coil model used. Coil features can also retrieve the value of the current or the voltage from a circuit connection, if the parameter coil excitation is set to *Circuit (current)* or *Circuit (voltage)*, respectively.



Circuit (current) excitation works similarly to the **Current** excitation, but in this case the inputs are provided by a circuit connection.

Circuit (voltage) excitation works similarly to the **Voltage** excitation, but in this case the inputs are provided by a circuit connection.

CURRENT EXCITATION

Coil with Single Conductor model

When specifying a total current I_{coil} , the coil applies an external electric field in the direction of the current flow, computed as:

$$E_e = \frac{V}{L} \quad (3-2)$$

where L is equal to the physics interface thickness d for 2D models, $2\pi r$ for 2D axially symmetric models, and the coil length in 3D models. V is an unknown applied potential. The potential V is solved for using an additional equation, which constrains the total integrated current to be equal to the current value I_{coil} specified, acting as a controller.

Coil with Homogenized Multi-Turn Model

When specifying a total current I_{coil} , the coil applies an external current density in the direction of the wires as in Equation 3-3 where N is the number of turns which are specified and A is the total cross section area of the coil domain.

$$J_e = \frac{NI_{\text{coil}}}{A} \quad (3-3)$$

Coil Group Mode

When the Coil Group mode is activated, additional equations are added to the model to enforce the equality of the current flowing in each domain or domain group.

Single-Turn Coil (in Magnetic and Electric Fields)

When specifying a total current I_{coil} , the out-of-plane component of the current density is defined as:

$$J_e = \frac{\sigma V}{L} \quad (3-4)$$

where L is equal to the physics interface thickness d for 2D models and $2\pi r$ for 2D axially symmetric models, and V is an unknown applied potential. The potential V is solved for using an additional algebraic equation, which constrains the total integrated current to be equal to the current value I_{coil} specified.

VOLTAGE EXCITATION

Coil with Single Conductor model

When specifying a total voltage V_{coil} , the externally applied electric field is computed as:

$$E_e = \frac{V_{\text{coil}}}{L} \quad (3-5)$$

where V_{coil} is the applied voltage specified, and L is equal to the physics interface's thickness d for 2D models, to $2\pi r$ for 2D axially symmetric models, and the coil length in 3D models.

Coil with Homogenized Multi-Turn model

When specifying a voltage V_{coil} , the component of the current density in the direction of the wires is defined as in Equation 3-6 and Equation 3-7.

$$J_e = \frac{N(V_{\text{coil}} + V_{\text{ind}})}{AR_{\text{coil}}} \quad (3-6)$$

where V_{coil} is the applied voltage which is specified, A is the total cross-sectional area of the coil domain, N is the number of turns specified, R_{coil} is the total resistance of the coil calculated as

$$R_{\text{coil}} = \int_A \frac{NL}{\sigma_{\text{coil}} a_{\text{coil}} A} \quad (3-7)$$

where L is equal to the physics interface's thickness d for 2D models, $2\pi r$ for 2D axially symmetric models, and the coil length in 3D models. The expression $\sigma_{\text{coil}} a_{\text{coil}}$ is the product of the wire bulk conductivity and wire cross-section area. V_{ind} is the induced voltage calculated by integrating the electric field along the coil.

Coil Group Mode

When Coil Group mode is activated, additional conditions are added to the model to constrain the sum of all the voltages in the domains or domains groups to be equal to the specified voltage:

$$V_{\text{coil}} = \sum_{i=1}^N V_i$$

where V_{coil} is the user-defined voltage drop across the coil, V_i is the individual applied potentials, and N is the number of turns in the coil group.

Single-Turn Coil (in Magnetic and Electric Fields)

When specifying a total voltage V_{coil} , the coil applies an out-of-plane external current density computed as:

$$J_e = \frac{\sigma V_{\text{coil}}}{L} \quad (3-8)$$

where V_{coil} is the applied voltage specified, and L is equal to the physics interface's thickness d for 2D models and equal to $2\pi r$ for 2D axially symmetric models.

POWER EXCITATION

In 2D and 2D axisymmetric models, **Power** is an option available for the coil excitation parameter. When Power is selected, the physics interface sets up the equation as specified in the Current Excitation section, plus a constraint between the coil current and voltage:

$$V_{coil}I_{coil} = P_{coil}$$

in stationary and time-dependent study steps, and

$$\frac{1}{2}\text{real}(V_{coil}I_{coil}^*) = P_{coil}$$

in frequency domain (cycle average). Select this option to specify the input power for the coils. The problem becomes nonlinear with these settings.



The **Power** option is not available for 3D models due to the increased complexity of the problem compared to 2D models.



This nonlinear system of equations requires special solver settings in order to converge. COMSOL Multiphysics automatically adds these solver settings when Power is selected.

Be aware that, in general, the values of the voltage and the current might not uniquely be determined by this constraint. Particularly in the frequency domain, the absolute phase of the quantities can be arbitrary. This indeterminacy can have an impact on the solution process. See [Compile Equations](#) in the *COMSOL Multiphysics Reference Manual* for a possible solution to this problem.



- [Coil](#)
 - [Single-Turn Coil](#)
 - [Studies and Solvers](#) in the *COMSOL Multiphysics Reference Manual*
-

Coil Groups

The Coil nodes, in 2D and 2D axisymmetry, present an additional **Coil Group** check box that allows to easily model one or more coil features connected in series. Each domain in the coil feature selection is considered a separate turn of the coil. Use this feature in 2D and 2D axisymmetric models for coils that cross the modeling plane more than once.

The Coil Group mode automatically sets up the relations between the variables associated to each domain. Current and voltage variables for each domain (or turn) are computed the same as for the base coil feature, while the total variables for the coil are computed using the rules for series-connection — the total voltage is the sum of the voltages, while the total current is equal to the current flowing in each domain.

Special subnodes can be added to the Coil nodes once the Coil Group check box has been selected in order to better control the setup of the connections:

Domain Group

When the Coil Group mode is active, each domain in the selection will be considered individually as a series-connected entity. The Domain Group subnode can be used to mark a group of domains which should be treated as one domain for the purpose of the coil set up. Multiple instances of this subnodes can be added to mark different groups. Domains that do not belong to a group are connected individually in series.

Reversed Current Direction

Use this subnode to mark a geometrical entity where the current flows in the opposite direction, that is antiparallel to the out-of-plane direction (z or azimuthal direction). This feature can be applied to any entity in the coil's selection, regardless of the group (if any) it belongs to.



In COMSOL Multiphysics version 4.3a and earlier, a separate **Coil Group Domain** node was available. This is replaced in the current version by a **Single-Turn Coil** domain node with the **Coil Group** check box selected.

Lumped Parameter Calculations

All the types of coil domains define lumped variables during the solution. These variables are defined in the global scope and have the template

`<variable>Coil_<name>`, where `<variable>` is the basic variable name (V for voltage, Z for impedance, and so forth) and `<name>` is the string specified in the **Coil**

name field. These variables can be evaluated during the analysis phase or used in expressions; in this case, the scope of the physics interface (for example, `mf` for the Magnetic Fields interface) must be added to the beginning of the variable name — for example, `mf.ICoil_1` is the total coil current flowing in the coil 1 in the physics interface identified by the name `mf`. A brief description of each of the variables follows.

THE VOLTAGE, CURRENT, AND POWER VARIABLES

The coil nodes define the variables V_{coil} , I_{coil} and P_{coil} . The variable corresponding to the quantity used for the coil excitation contains the input value, while the others have values computed from the solution according to the coil model.

STATIONARY AND TIME DEPENDENT STUDIES

In Stationary and Time Dependent studies, the coil feature defines the coil resistance variable, R_{coil} , with the formula:

$$R_{\text{coil}} = \frac{V_{\text{coil}}}{I_{\text{coil}}}$$

FREQUENCY DOMAIN STUDIES

In frequency domain studies, the following lumped variables are defined.

TABLE 3-1: LUMPED VARIABLES FOR THE FREQUENCY DOMAIN STUDIES

VARIABLE	EQUATION
Impedance	$Z_{\text{coil}} = \frac{V_{\text{coil}}}{I_{\text{coil}}}$
Resistance	$R_{\text{coil}} = \text{real}(Z_{\text{coil}})$
Inductance	$L_{\text{coil}} = \frac{\text{imag}(Z_{\text{coil}})}{\omega}$
Reactance	$X_{\text{coil}} = \text{imag}(Z_{\text{coil}})$
Admittance	$Y_{\text{coil}} = Z_{\text{coil}}^{-1}$

FREQUENCY DOMAIN, PERTURBATION STUDIES

In frequency domain perturbation studies (small-signal analysis), the parameters defined are the same as in the frequency domain study, but the impedance is computed using the harmonic voltage and current around the linearization point:

$$Z_{\text{coil}} = \frac{\text{lindev}(V_{\text{coil}})}{\text{lindev}(I_{\text{coil}})}$$



- [lindev](#) in the *COMSOL Multiphysics Reference Manual*
- [Coil](#)
- [Single-Turn Coil](#)
- [RLC Coil Group](#)

The Single-Turn Coil Feature

The [Single-Turn Coil](#) feature models a single, solid region of a conducting material (for example, metal) in which the current flows. The lumped voltage and current of the coil correspond, respectively, to the integral of the electric field along the coil length and to the integral of the current density on a cross section. Use the Single-Turn Coil domain node to model a single wire with a nonnegligible cross section; the Single-Turn Coil boundary node can be used for a thin conductive layer whose thickness is negligible (for example, in frequency domain, it is small with respect to the skin depth).



In COMSOL Multiphysics version 5.2 and earlier, the **Single-Turn Coil** was available in [The Magnetic Fields Interface](#) and [The Rotating Machinery, Magnetic Interface](#). The functionality provided by this feature has been incorporated in the [Coil](#) feature in the form of the **Single conductor** option.

To preserve backward compatibility, the Single-Turn Coil features present in models created in version 5.2 and earlier will still be available when opening the models in the current version, but it is recommended to replace them with the new [Coil](#) feature.



Selecting unconnected geometrical entities with a Single-Turn Coil connects them in parallel.



For a examples of a Single-Turn Coil, see:

- *Inductive Heating of a Copper Cylinder*: Application Library path **ACDC_Module/Electromagnetic_Heating/inductive_heating**
 - *Tutorial Example: Modeling a 3D Inductor* (described in detail in the *Intruction to the AC/DC Module* manual): Application Library path **ACDC_Module/Inductive_Devices_and_Coils/inductor_3d**.
-

Using Coils in 3D Models

The Coil feature applies an external electric field or current density along the direction of the coil. The nodes require additional settings in 3D models to determine the geometry and the direction of the current flow.

COIL FEATURE

The options available in a **Coil** feature depend on the chosen **Conductor model**:

- When **Single conductor** is used, the coil direction is computed in the dedicated preprocessing study step **Coil Geometry Analysis**.
- When **Homogenized multi-turn** is used, the **Coil type** input determines how the direction of the current flow is specified. The available alternatives are: **Linear**, **Circular**, **Numeric** and **User defined**. The Numeric option computes the current flow in the dedicated preprocessing study step **Coil Geometry Analysis**. The other three options do not require any preprocessing.



The **Single conductor Conductor model** can be used in **Stationary**, **Frequency Domain** and **Time Dependent** studies. However it only supports homogeneous/constant conductivity in the entire coil. If you need to use inhomogeneous or temperature dependent coil conductivity, use the **Magnetic and Electric Fields** physics instead.

The **Homogenized multi-turn Conductor model** supports the **Stationary**, **Frequency Domain** and **Time Dependent** studies.

In the **Homogenized multi-turn** case, the coil type determines how the direction of the wires constituting the coil is specified, as well as the method used to compute the average length and the average cross-section area of the domain or boundary. The coil length and coil area are used to compute lumped variables, such as the induced voltage or the total resistance.

For models representing only a part of the geometry (due to symmetry), the total length and cross-section area of the coil (referred to as coil length and coil area) are computed by multiplying the domain or boundary length and area by the appropriate multiplication factors specified under **Symmetry specification** in the subfeatures.

The following sections detail the possible options available for the Coil feature.

Homogenized Multi-Turn Model — Linear Coil Type

In a *linear coil*, the wires are straight and parallel. To specify the direction of the wires, use the default **Coil Geometry** subnode to select a straight edge or a group of collinear straight edges along the entire length of the coil. The coil direction is taken to be the tangential vector to the edges (shown in the Graphics window with a red arrow), while the length of the wires in the domain is the total length of the edges. If the length of the edges does not correspond to the length of the domain, select the **Override length of the edges** check box and specify the correct length. For domain features, the average domain cross-section area is computed from the domain volume and the length. To specify another cross-section area, select the **Override domain area** check box and specify the correct area.

Homogenized Multi-Turn Model — Circular Coil Type

In a *circular coil*, the wires are wound in circles around a common axis. To specify the direction of the wires, use the default **Coil Geometry** subnode to select a circular edge or group of edges. The feature will compute the coil axis and the wire directions by analyzing the curvature of the selected edges. The total length of the edges is taken to be the average wire length in the domain, so it is appropriate to select a group of edges close to the average radius of the coil. If the length of the edges does not correspond to the length of the domain, select the **Override length of the edges** check box and specify the correct length. For domain features, the average domain cross-section area is computed from the domain volume and the length. To specify another cross-section area, select the **Override domain area** check box and specify the correct area.

The geometry analysis algorithm can determine the axis and direction only if there is a geometry in the model. If the model does not have a geometry, for example when using imported meshes, use the alternative analysis method by selecting the **Use robust geometry analysis method** check box. This method can be used even without a geometry, but it requires that the selected edges form a complete circle to work correctly. If neither the default method nor the alternative method work, an alternative is to set the **Coil type** to **User defined** and manually specify the direction of the wires using a **Cylindrical System**.

Homogenized Multi-Turn Model — Numeric Coil Type

In a *numeric coil*, the path of the wires in the coil is computed numerically in an additional study step during the solution. This allows the modeling of coils with complex shapes. To set up the numerical analysis computation of the current flow in a coil, additional information on the coil geometry must be provided by means of the default **Geometry Analysis** subnode and the boundary conditions under it.

By default, the [Input \(for Geometry Analysis\)](#) boundary condition is available under the **Geometry Analysis** subnode. For open coils (whose ends are on exterior boundaries), apply this condition on the input boundary, that is, the boundary at which the wires enter the coil domain. Right-click the Geometry Analysis node, add an [Output \(for Geometry Analysis\)](#) subnode, and apply it on the exterior boundary where the wires exit the domain.

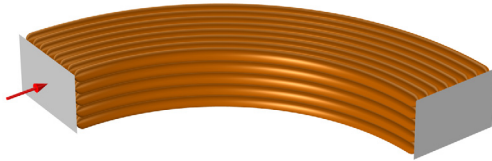

For closed-loop coils, apply the Input boundary condition on an interior boundary orthogonal to the direction of the wires.

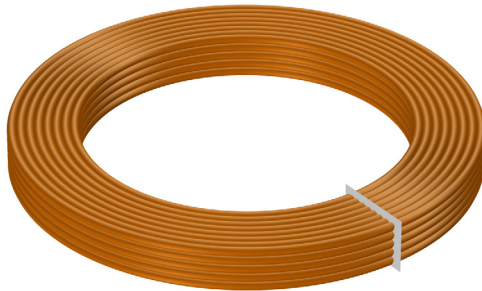

To complete the set up, add a **Coil Geometry Analysis** study step to the study, before the main study step.



The Coil Geometry Analysis can process multiple coils in the same step. In order to analyze only certain coils, select the **Solve only specific coils** check box and enter the coil names as a comma-separated list.



- [Automatic Coil Geometry Analysis](#)
- [Coil Geometry Analysis](#) in the *COMSOL Multiphysics Reference Manual*

Homogenized Multi-Turn Model — User-Defined Coil Type

In a *user-defined* coil, the current flow (the direction of the wires) can be entered as an arbitrary vector field in the **User-Defined Coil Geometry** subnode. The vector field entered can be an analytical expression or the solution of another physics (for instance, the vector field computed by a **Curvilinear Coordinates** interface). In order for the magnetic problem to have a solution, the vector field must be as much as possible divergence-free, meaning that the current flow cannot have sources or sinks within the simulation domain nor can it originate from interior boundaries. In practice, this means that the current flow must either be terminated on exterior boundaries, or it must be closed in a loop.

Since the coil feature does not have any information on the geometry, additional settings are required:

- Enter the **Domain length** (for domain features) or the **Boundary length** (for boundary feature), which should be the average length of the coil from the input to the output — the average length of a wire, not accounting for symmetry nor the number of turns.
- For domain features, use the subnodes to **User Defined Coil Geometry — Input** and **Output** — to select the coil input and output boundaries, where the current flow enters or leaves the simulation domain. If the coil is closed in a loop, no selection is required.

Single Conductor Model

The setup of the Coil when using the Single conductor model is similar to the setup required for the [Homogenized Multi-Turn Model — Numeric Coil Type](#) case, the only difference being that the Coil Geometry Analysis study step will compute the

physical current flow, instead of the direction of the wires. Refer to that section for more information.

SINGLE-TURN COIL

The 3D [Single-Turn Coil](#) feature was available in [The Magnetic Fields Interface](#) in previous versions of COMSOL Multiphysics. This feature is obsolete — the recommended approach to model the same physical system is to use a **Coil** feature with the **Single conductor** model, or [The Magnetic and Electric Fields Interface](#).

The feature is still available for backward compatibility when opening models created in previous versions of the software.

This node represents a solid conducting domain, typically a wire or a coil, with a nonnegligible cross section. The boundary node represents a conducting thin layer whose thickness is small (also compared to the skin depth). To enforce the current conservation in the domain, an additional dependent variable with the dimension of an electric potential (SI unit: V) is added to the problem and the continuity equation for the current is introduced in the system of equations. This variable is referred to as the *coil potential*, but it is only loosely related to the electrostatic potential and it should be considered a help variable rather than representing a tangible physical quantity. In the Single-Turn Coil node, it is possible to specify the material properties that are used in the continuity equation.

The excitation is applied by means of specialized subnodes: a [Boundary Feed](#) subnode applies constraints on the coil potential to an external boundary, while a [Ground](#) subnode enforces the coil potential to be zero on the selected boundaries.



To ensure that the current continuity equation has a physical solution, terminate a coil domain on external boundaries only, or close it into a loop.

A [Gap Feed](#) subnode models a thin gap in the conductive domain across which a difference of potential or a current is applied. This feature should be applied on interior boundaries to the conductive domain and is useful for modeling closed loops.



For the Single-Turn Coil feature, only one active feed feature can be used at a time. That is, either a Boundary Feed or Gap Feed feature can be used, not both.



The Gap Feed should be used with care in high frequency modeling as there is a mesh dependent displacement current density flowing in the elements just outside the bounding edges of the Gap Feed boundary. If these elements have nonzero conductivity, this problem can appear even at lower frequencies.

Automatic Coil Geometry Analysis

In 3D models, it is possible to perform an automatic analysis of the geometry of a **Coil** to determine the local direction of the current flow in the domain given the input and output boundaries of the coil (or an interior boundary in the case of closed-loop coils). The analysis is performed in a dedicated study step, **Coil Geometry Analysis**, which is typically solved before the main study step.

The study step can be used to compute both the current flow when using the **Single conductor** model and the direction of the wires when using the **Homogenized multi-turn** model.

In the case of a **Single conductor** coil, the study step solves a simple current conservation problem to determine the flow of a current applied to the metallic domain.

In the case of a **Homogenized multi-turn** coil, the feature computes a vector field **e** which represents the local wire density in the coil, as well as the length and average cross-section of the wires. The vector variable **eCoil** can be plotted (for example, in a **Streamline** or **Arrow Volume** plot) to visualize the computed direction of the wires.



The **Coil Geometry Analysis** study step must precede the main study step (for example, a Stationary study step) in which the Coil is used.



The **Coil Geometry Analysis** study step analyzes simultaneously the geometry of all coils in the physics that are active in the study — even if they use different Conductor models. To analyze only specific coils, select the **Solve only specific coils** check box in the study step and enter the names of the desired coils in the **Coil names** input field as a comma-separated list.

The coil geometry analysis method tries to construct a coil wires density that is plausible for an actual bundle of thin wires. The computed wire density is constant over arbitrary cross section, without violating current conservation for the current flowing

in the wires. The density will depend on the local cross-section area of the coil (for example, it will increase in choke points), and will remain approximately constant in bends and curved regions as long as the cross-section area does not change. The analysis method will compute a solution even in presence of sharp bends, but the resultant wire density may not be constant. For best results, try to avoid sharp bends in the coil geometry.

BACKWARD COMPATIBILITY WITH COIL CURRENT CALCULATION

The **Coil Geometry Analysis** replaces the **Coil Current Calculation** functionality available in previous versions of COMSOL Multiphysics. The new formulation is more robust and has a larger applicability than the previous one, as well as a number of improvements, such as support for solving multiple coils at once or for coils with nonconstant cross section. When opening a model saved in an older version of COMSOL Multiphysics, the Coil Current Calculation study steps are transparently updated to use the new formulation. It may however be necessary to regenerate the default solvers before proceeding with the solution.

ADVANCED SOLVER SETTINGS

Depending on the type of coils used in the model, the Coil Geometry Analysis may use a Stationary solver with a Segregated node to perform the analysis. The default solver settings should suffice in most cases, but they can be adjusted if the analysis fails to provide a satisfying solution. The Number of iterations in the Segregated solver can be used to tune the robustness of the method. Lower values improve the stability of the solution, but the condition that the wire density must be constant is weakened.

The Segregated solver uses Geometric Multigrid to solve the linear system associated with the analysis. If the Geometric Multigrid causes problems during the solution (for example, in presence of very coarse meshes), the direct solver can be used instead. Change the **Linear solver** in all Segregated Steps nodes to **Direct**.



- [About the Coil Features](#)
- [Studies and Solvers](#) in the *COMSOL Multiphysics Reference Manual*

Accurate Coil Voltage Calculation

This functionality improves the accuracy of the computation of the lumped coil voltage in time dependent and frequency domain studies, in 3D, when using the **Homogenized multi-turn** conductor model. Other lumped parameters computed from the voltage

using Ohm's Law, such as the coil impedance, inductance, and power, also benefit from the improved accuracy. The functionality is enabled by default in time dependent and frequency domain studies, and can be manually controlled using the corresponding check box in the Coil **Settings** window, **Stabilization** section. The **Stabilization** section can be shown by clicking the **Show More Options** button () and selecting **Stabilization** in the **Show More Options** dialog box. It is only available when the **Conductor model** is set to **Homogenized multi-turn**.

For domain coils¹, the Accurate coil voltage calculation functionality performs a filtering of the external current density applied by the coil to obtain a current density vector field that is numerically divergence free. The filtering is performed by introducing an additional scalar degree of freedom V_f (the filtering variable) and solving the equation

$$\nabla \cdot (\nabla V_f - \mathbf{J}_u) = 0$$

in the coil domain, where \mathbf{J}_u is the unfiltered external current density applied by the Coil feature. The filtered current density

$$\mathbf{J}_e = \nabla V_f - \mathbf{J}_u$$

is then applied as right-hand side in the magnetic equations. This filtering reduces the spurious electric fields in the solution, in turn improving the accuracy of the induced voltage (which is computed by integrating the electric field in the coil domain).

The filtering equation requires appropriate boundary conditions for the filtering variable, in particular, on the inlet and outlet boundaries of the coil, where the external current density is orthogonal. The approach used to set up these boundary conditions vary according to the coil geometry:

- For **Linear** and **Circular** coils, the geometry analysis algorithm automatically detects the inlet/outlet boundaries from the geometry. If this detection fails, use the [Override Coil Inlet/Outlet](#) subnode to manually select the inlet/outlet boundaries. Right-click the Coil node to add this subnode.
- For **Numeric** coils, the subnodes of the [Geometry Analysis](#) node are used to identify the inlet/outlet boundaries.
- For **User defined** coils, use the subfeatures of the [User Defined Coil Geometry](#) subnode — **Input** and **Output** — to select the coil inlet/outlet boundaries.

1. For boundary coils, the filtering turns into a local in-plane 2D formulation. Apart from that, it is mathematically equivalent to the domain coil case.

Lumped Parameters

Lumped parameters are matrices describing electromagnetic properties such as resistance, capacitance, and inductance. In the time-harmonic case the lumped parameter matrix is either an impedance matrix or an admittance matrix depending on how the model is excited (current or voltage). In a static calculation only the resistive, capacitive, or inductive part of the lumped parameter matrix is obtained.

In this section:

- [Calculating Lumped Parameters with Ohm's Law](#)
- [Calculating Lumped Parameters Using the Energy Method](#)
- [Studying Lumped Parameters](#)
- [Lumped Parameter Conversion](#)

Calculating Lumped Parameters with Ohm's Law

To calculate the lumped parameters, there must be at least two electrodes in the system, one of which must be grounded. Either a voltage or a current can be forced on the electrodes. After the simulation, extract the other property or the energy and use it when calculating the lumped parameter.

There are several available techniques to extract the lumped parameters. Which one to use depends on the physics interface, the parameter of interest, and how the model is solved. The overview of the techniques in this section use a 4-by-4 matrix example for the lumped parameter matrix. This represents a system of at least five electrodes, where four are used as terminals and the rest are grounded, as illustrated in [Figure 3-2](#).

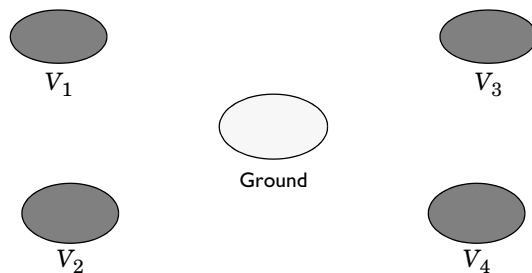

Figure 3-2: A five-electrode system with 4 terminals and one ground electrode.

If a system specifies that all electrodes are terminals, the results are redundant matrix elements. This is better understood by considering a two-electrode system. If both electrodes are declared as terminals, a 2-by-2 matrix is obtained for the system. This is clearly too many elements because there is only one unique lumped parameter between the terminals. If in addition one or more ground electrodes are declared, the system has three unique electrodes and the lumped parameter matrix becomes a 2-by-2 matrix.

FORCED VOLTAGE

If voltages are applied to the terminals, the extracted currents represent elements in the admittance matrix, \mathbf{Y} . This matrix determines the relation between the applied voltages and the corresponding currents with the formula

$$\begin{bmatrix} I_1 \\ I_2 \\ I_4 \\ I_4 \end{bmatrix} = \begin{bmatrix} Y_{11} & Y_{12} & Y_{13} & Y_{14} \\ Y_{21} & Y_{22} & Y_{23} & Y_{24} \\ Y_{31} & Y_{32} & Y_{33} & Y_{34} \\ Y_{41} & Y_{42} & Y_{43} & Y_{44} \end{bmatrix} \begin{bmatrix} V_1 \\ V_2 \\ V_3 \\ V_4 \end{bmatrix}$$

so when V_1 is nonzero and all other voltages are zero, the vector I is proportional to the first column of \mathbf{Y} .

In electrostatics the current is replaced with charge and the admittance matrix is replaced with the capacitance matrix

$$\begin{bmatrix} Q_1 \\ Q_2 \\ Q_4 \\ Q_4 \end{bmatrix} = \begin{bmatrix} C_{11} & C_{12} & C_{13} & C_{14} \\ C_{21} & C_{22} & C_{23} & C_{24} \\ C_{31} & C_{32} & C_{33} & C_{34} \\ C_{41} & C_{42} & C_{43} & C_{44} \end{bmatrix} \begin{bmatrix} V_1 \\ V_2 \\ V_3 \\ V_4 \end{bmatrix}$$

FIXED CURRENT

It might be necessary to calculate the \mathbf{Z} -matrix in a more direct way. Similar to the \mathbf{Y} calculation, the \mathbf{Z} calculation can be done by forcing the current through one terminal at the time to a nonzero value while the others are set to zero. Then, the columns of the impedance matrix are proportional to the voltage values on all terminals:

$$\begin{bmatrix} V_1 \\ V_2 \\ V_3 \\ V_4 \end{bmatrix} = \begin{bmatrix} Z_{11} & Z_{12} & Z_{13} & Z_{14} \\ Z_{21} & Z_{22} & Z_{23} & Z_{24} \\ Z_{31} & Z_{32} & Z_{33} & Z_{34} \\ Z_{41} & Z_{42} & Z_{43} & Z_{44} \end{bmatrix} \begin{bmatrix} I_1 \\ I_2 \\ I_3 \\ I_4 \end{bmatrix}$$

In magnetostatics this option means that the energy method is used; see [Calculating Lumped Parameters Using the Energy Method](#) below.

FIXED CHARGE

The Electrostatics interface can use total charge instead of total current. This gives the inverted capacitance matrix in a similar manner as the \mathbf{Z} and \mathbf{Y} matrices.

$$\begin{bmatrix} V_1 \\ V_2 \\ V_3 \\ V_4 \end{bmatrix} = \begin{bmatrix} C_{11} & C_{12} & C_{13} & C_{14} \\ C_{21} & C_{22} & C_{23} & C_{24} \\ C_{31} & C_{32} & C_{33} & C_{34} \\ C_{41} & C_{42} & C_{43} & C_{44} \end{bmatrix}^{-1} \begin{bmatrix} Q_1 \\ Q_2 \\ Q_4 \\ Q_4 \end{bmatrix}$$

Calculating Lumped Parameters Using the Energy Method

When using this method the potential or the current is nonzero on one or two terminals at a time and the energy density is extracted and integrated over the whole geometry. The following formulas show how to calculate the capacitance matrix from the integral of the electric energy density.

$$C_{ii} = \frac{2}{V_i^2} \int_{\Omega} W_e d\Omega \quad V_j = \begin{cases} 0 & j \neq i \\ V_i & j = i \end{cases}$$

$$C_{ij} = \frac{1}{V_i V_j} \int_{\Omega} W_e d\Omega - \frac{1}{2} \left(\frac{V_i}{V_j} C_{ii} + \frac{V_j}{V_i} C_{jj} \right) \quad V_k = \begin{cases} 0 & k \neq i, j \\ V_i & k = i \\ V_j & k = j \end{cases}$$

Calculate the inductance matrix in the same way from the magnetic energy density:

$$L_{ii} = \frac{2}{I_i^2} \int_{\Omega} W_m d\Omega \quad I_j = \begin{cases} 0 & j \neq i \\ I_i & j = i \end{cases}$$

$$L_{ij} = \frac{1}{I_i I_j} \int_{\Omega} W_m d\Omega - \frac{1}{2} \left(\frac{I_i}{I_j} L_{ii} + \frac{I_j}{I_i} L_{jj} \right) \quad I_k = \begin{cases} 0 & k \neq i, j \\ I_i & k = i \\ I_j & k = j \end{cases}$$

This is the technique used when **Fixed current** is selected.

Studying Lumped Parameters

To study lumped parameters, use the terminal boundary or domain condition for each electrode. This condition is available in the following interfaces and the methods described in the previous section are used to calculate the lumped parameters:

- Electrostatics. Uses a stationary study and the energy method.
- Electric Currents. Uses a stationary or frequency domain study type using the method based on Ohm's law.
- Magnetic and Electric Fields (only available as boundary condition and only when the electric potential is one of the dependent variables). For the stationary study the energy method is used. For the Frequency Domain study type, the method based on Ohm's law is used.

The lumped parameters are defined as global variables. Evaluate these from the **Derived Values** node under **Results** in the Model Builder or define 1D plot groups.

SWEEP SETTINGS AND TOUCHSTONE EXPORT

In the main node of the physics interface, activate a sweep to loop the excitation over the terminals in the model and calculate a lumped parameter matrix. For frequency domain models there is also an inner loop with a frequency sweep for each terminal and the lumped parameters are exported to a Touchstone file. The generated lumped parameters are in the form of an impedance or admittance matrix depending on the terminal settings. They must consistently be of either fixed voltage (for an admittance matrix) or fixed current type (for an impedance matrix).

ACCURACY

Use reaction terms to be accurate when calculating the total current over the boundary. This is necessary for the forced voltage input property. The reaction terms (representing current or charge density) come from default information stored in the

solution, which gives an exact calculation of the total fluxes on boundaries with constraints. They do not change the system of equations in any way — no special solver settings are required. The reaction terms are also stored by default. It is recommended to use forced voltage input property with reaction terms in the extraction of the lumped parameters. Lumped parameter variables based on voltage excitation are only available when reaction fluxes are included in the output. The optional current excitation performs a coupling that guarantees that the total current is equal to the specified value, although one cannot verify this without using reaction terms.

Lumped Parameter Conversion

When the impedance matrix, \mathbf{Z} , or the admittance matrix, \mathbf{Y} , is available it is possible to calculate all other types of lumped parameter matrices from the relations below.

$$\mathbf{S} = \mathbf{G}_{\text{ref}} \cdot (\mathbf{E} - (\mathbf{Z}_{\text{ref}}^* \cdot \mathbf{Y})) \cdot (\mathbf{E} + \mathbf{Z}_{\text{ref}} \cdot \mathbf{Y})^{-1} \cdot \mathbf{G}_{\text{ref}}^{-1},$$

$$\mathbf{Z} = \mathbf{Y}^{-1}, \quad \mathbf{L} = \frac{\text{Im}(\mathbf{Z})}{\omega}, \quad \mathbf{C} = \frac{\text{Im}(\mathbf{Y})}{\omega},$$

$$\mathbf{R} = \text{Re}(\mathbf{Z}), \quad \mathbf{G} = \text{Re}(\mathbf{Y})$$

where \mathbf{L} is the inductance, \mathbf{C} is the capacitance, \mathbf{R} is the resistance, and \mathbf{G} is the conductance. \mathbf{S} is the S-parameter. The relations also include the following matrices

$$\mathbf{E} = \begin{bmatrix} 1 & 0 & 0 & 0 \\ 0 & 1 & 0 & 0 \\ 0 & 0 & 1 & 0 \\ 0 & 0 & 0 & 1 \end{bmatrix}$$

$$\mathbf{Z}_{\text{ref}} = \mathbf{E} \cdot Z_0$$

$$\mathbf{G}_{\text{ref}} = \mathbf{E} \cdot \frac{1}{2\sqrt{\text{Re}(Z_0)}}$$

where Z_0 is the characteristic impedance.

For capacitance matrix calculations special transformations are available to obtain the mutual or SPICE capacitance matrix from the basic output from the solver. The latter is, for voltage excitation the so called Maxwell capacitance matrix and, for charge excitation the inverse Maxwell capacitance matrix. The Maxwell capacitance values, terminal charges, and terminal voltages are linked by the following matrix relation:

$$\begin{bmatrix} Q_1 \\ Q_2 \\ Q_3 \end{bmatrix} = \begin{bmatrix} C_{11} & C_{12} & C_{13} \\ C_{21} & C_{22} & C_{23} \\ C_{31} & C_{32} & C_{33} \end{bmatrix} \begin{bmatrix} V_1 \\ V_2 \\ V_3 \end{bmatrix} \quad (3-9)$$

where Q is charge, V is voltage, and C is the Maxwell capacitance matrix.

In order to analyze the response of a device, it is more common to use the form of a mutual capacitance matrix. The mutual capacitance matrix can be converted from the Maxwell capacitance matrix:

$$\begin{bmatrix} C_{m11} & C_{m12} & C_{m13} \\ C_{m21} & C_{m22} & C_{m23} \\ C_{m31} & C_{m32} & C_{m33} \end{bmatrix} = \begin{bmatrix} C_{M11} + C_{M12} + C_{M13} & -C_{M12} & -C_{M13} \\ -C_{M21} & C_{M21} + C_{M22} + C_{M23} & -C_{M23} \\ -C_{M31} & -C_{M32} & C_{M31} + C_{M32} + C_{M33} \end{bmatrix} \quad (3-10)$$

where C_{Mij} are elements of the Maxwell capacitance matrix and C_{mij} are elements of the mutual capacitance matrix.

The basic steps of this conversion are:

- 1 Set each diagonal element of the mutual capacitance matrix to the sum of the corresponding row elements of the Maxwell capacitance matrix (that is, to get C_{m11} , sum C_{M1j} for all j).
- 2 Reverse the sign of all of the off-diagonal elements in the Maxwell capacitance matrix to get the corresponding mutual capacitance matrix elements.

This conversion can also be used to transform resistance and conductance matrices obtained from the **Electric Currents** physics. In that context the output resistance matrix corresponds to the inverse Maxwell capacitance matrix, electrode currents correspond to charges and the mutual or SPICE conductance matrix corresponds to the mutual or SPICE capacitance matrix.

You can compute conversions between the various matrices (\mathbf{Z} , \mathbf{Y} , \mathbf{S} , \mathbf{C}_{Max} , \mathbf{C}_{mut}) in a results table using the **Settings** window for the **Global Matrix Evaluation** node, which you can add under **Results>Derived Values**.



Global Matrix Evaluation in the *COMSOL Multiphysics Reference Manual*

Stationary Source Sweep

For the Electrostatics, the Electrostatics, Boundary Elements and the Electric Currents interfaces there is a special study step for efficient calculation of capacitance and resistance matrices respectively. The **Stationary Source Sweep** () identifies all terminals (domain or boundary) in the model and excites them one at a time using a fixed charge or current (overriding the settings on the **Terminal** features). While one Terminal is excited, the others will be floating with zero net charge/current.



To get a proper matrix definition, at least one **Ground** node should be specified in the model. This is particularly important as the Stationary Source Sweep does not add any constraint on the electric potential.

Matrix Output

The resulting potential values at the terminals are used to extract one of the lumped matrices according to the following table.

PHYSICS	BASE LUMPED PARAMETER MATRIX
Electrostatics & Electrostatics, Boundary Elements	Inverse Maxwell capacitance matrix
Electric Currents	Resistance matrix

During postprocessing, other matrices can be produced via the **Global Matrix Evaluation**. The settings for Global Matrix Evaluation has a **Transformation** section that allows for the output of the Maxwell capacitance matrix or the mutual capacitance matrix.



If the **Generate default plots** check box on the Study node is enabled, default **Global Matrix Evaluation** nodes for matrix output are generated.

Solver Selection

The Stationary Source Sweep is optimized for solution speed. It works best with a direct solver as the LU decomposition has to be performed only once, followed by back substitution for the multiple source excitations (multiple right-hand sides). For 3D models, the Stationary Source Sweep generates both an iterative and a direct solver. The former will be selected if the model is having a large number of elements; that is, a number that is above a built-in threshold. For hardware with sufficiently large RAM, it is recommended to manually switch to the direct solver.



For 3D models involving the **Electrostatics, Boundary Elements** physics, direct solvers scale poorly with problem size so some caution is recommended.

Voltage Output

With unit charge feeding the absolute value of the electric potential is difficult to predict. For this reason there is an auxiliary global variable — for example, `es.VexcTerm` — that represents the value of potential of the excited terminal. The default potential plots will typically show the electric potential scaled by this value.

Compatibility with Other Study Types

Combining the Stationary Source Sweep with the **Parametric Sweep** study node should only be done after careful consideration. If you need to perform more general parameter sweeps, it is often more appropriate to activate the manual terminal sweep in the settings of the main physics node and set up Parametric Sweeps manually. Other study nodes will work with Stationary Source Sweep as it was a standard Stationary (parametric) study. In particular, this is valid also for Optimization and Sensitivity studies.

Lumped Ports with Voltage Input

In this section:

- [About Lumped Ports](#)
- [Lumped Port Parameters](#)

About Lumped Ports

Lumped ports are used to model a connecting transmission line or as a voltage or current source applied between electrodes. For example, apply a lumped port directly to a printed circuit board or to the transmission line feed of a device. The lumped port must be applied between two metallic objects separated by a distance much smaller than the wavelength, that is a local *quasi-static approximation* must be justified. This is because the concept of port or gap voltage breaks down unless the gap is much smaller than the local wavelength.

A lumped port specified as an input port calculates the impedance, Z_{port} , and S_{11} S-parameter for that port. The parameters are directly given by the relations

$$Z_{\text{port}} = \frac{V_{\text{port}}}{I_{\text{port}}}$$
$$S_{11} = \frac{V_{\text{port}} - V_{\text{in}}}{V_{\text{in}}}$$

where V_{port} is the extracted voltage for the port given by the electric field line integral between the terminals averaged over the entire port. The current I_{port} is the averaged total current over all cross sections parallel to the terminals. Ports not specified as input ports only return the extracted voltage and current.



[Lumped Port Parameters](#)

Lumped Port Parameters

In transmission line theory voltages and currents are dealt with rather than electric and magnetic fields, so the lumped port provides an interface between them. The

requirement on a lumped port is that the feed point must be similar to a transmission line feed, so its gap must be much less than the wavelength. It is then possible to define the electric field from the voltage as

$$V = \int_h \mathbf{E} \cdot d\mathbf{l} = \int_h (\mathbf{E} \cdot \mathbf{a}_h) dl$$

where h is a line between the terminals at the beginning of the transmission line, and the integration is going from positive (phase) V to ground. The current is positive going into the terminal at positive V .

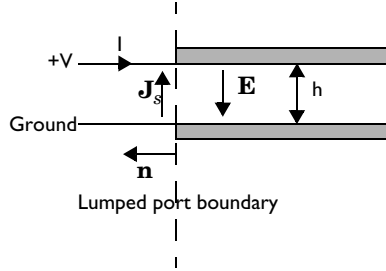

The transmission line current can be represented with a surface current at the lumped port boundary directed opposite to the electric field.

The impedance of a transmission line is defined as

$$Z = \frac{V}{I}$$

and in analogy to this an equivalent surface impedance is defined at the lumped port boundary

$$\eta = \frac{\mathbf{E} \cdot \mathbf{a}_h}{\mathbf{J}_s \cdot (-\mathbf{a}_h)}$$

To calculate the surface current density from the current, integrate along the width, w , of the transmission line

$$I = \int_w (\mathbf{n} \times \mathbf{J}_s) \cdot d\mathbf{l} = -\int_w (\mathbf{J}_s \cdot \mathbf{a}_h) dl$$

where the integration is taken in the direction of $\mathbf{a}_h \times \mathbf{n}$. This gives the following relation between the transmission line impedance and the surface impedance

$$Z = \frac{V}{I} = \frac{\int (\mathbf{E} \cdot \mathbf{a}_h) dl}{-\int_w (\mathbf{J}_s \cdot \mathbf{a}_h) dl} = \eta \frac{\int (\mathbf{E} \cdot \mathbf{a}_h) dl}{\int_w (\mathbf{E} \cdot \mathbf{a}_h) dl} \approx \eta \frac{h}{w} \Rightarrow$$

$$\eta = Z \frac{w}{h}$$

where the last approximation assumed that the electric field is constant over the integrations. A similar relationship can be derived for coaxial cables

$$\eta = Z \frac{2\pi}{\ln \frac{b}{a}}$$

The transfer equations above are used in an impedance type boundary condition, relating surface current density to tangential electric field via the surface impedance.

$$\mathbf{n} \times (\mathbf{H}_1 - \mathbf{H}_2) + \frac{1}{\eta} \mathbf{n} \times (\mathbf{E} \times \mathbf{n}) = 2 \frac{1}{\eta} \mathbf{n} \times (\mathbf{E}_0 \times \mathbf{n})$$

where \mathbf{E} is the total field and \mathbf{E}_0 the incident field, corresponding to the total voltage, V , and incident voltage, V_0 , at the port.



When using the lumped port as a circuit port, the port voltage is fed as input to the circuit and the current computed by the circuit is applied as a uniform current density, that is as a surface current condition. Thus, an open (unconnected) circuit port is just a continuity condition.

S-Parameters and Ports

In this section:

- [S-Parameters in Terms of Voltage and Electric Field](#)
- [S-Parameter Calculations](#)
- [S-Parameter Variables](#)
- [Port Sweeps/Manual Terminal Sweeps and Touchstone Export](#)

S-Parameters in Terms of Voltage and Electric Field

Scattering parameters (or S-parameters) are complex-valued, frequency dependent matrices describing the transmission and reflection of electromagnetic waves at different ports of devices like filters, antennas, waveguide transitions, and transmission lines. S-parameters originate from transmission-line theory and are defined in terms of transmitted and reflected voltage waves. All ports are assumed to be connected to matched loads/feeds, that is, there is no reflection directly at a port.

For a device with n ports, the S-parameters are

$$S = \begin{bmatrix} S_{11} & S_{12} & \cdots & S_{1n} \\ S_{21} & S_{22} & \cdots & \cdot \\ \cdot & \cdot & \cdots & \cdot \\ \cdot & \cdot & \cdots & \cdot \\ S_{n1} & \cdot & \cdots & S_{nn} \end{bmatrix}$$

where S_{11} is the voltage reflection coefficient at port 1, S_{21} is the voltage transmission coefficient from port 1 to port 2, and so on. The time average power reflection/transmission coefficients are obtained as $|S_{ij}|^2$.

Now, for high-frequency problems, voltage is not a well-defined entity, and it is necessary to define the scattering parameters in terms of the electric field.



For details on how COMSOL Multiphysics calculates the S-parameters, see [S-Parameter Calculations](#).

S-Parameter Calculations

The AC/DC interfaces have built-in support for S-parameter calculations. For connecting transmission lines and other lumped feeds, use a *lumped port* that approximates a connecting transmission lines or a voltage source with a known internal impedance. The lumped port should only be used when the port width is much smaller than the wavelength. In the Electric Currents and Electrostatics interfaces, use the *terminal* feature with the *terminated* setting to approximate a connecting transmission line or a voltage source with a known internal impedance. For a terminal the voltage measurement is always with respect to ground so at least one *ground* feature is also required in the model.



- For more details about lumped ports, see [Lumped Ports with Voltage Input](#).
- See [Lumped Port](#) for instructions to set up a model.

S-Parameter Variables

This module automatically generates variables for the S-parameters. The port names (use numbers for sweeps to work correctly) determine the variable names. If, for example, there are two lumped ports with the numbers 1 and 2 and Lumped Port 1 is the inport, the software generates the variables S11 and S21. S11 is the S-parameter for the reflected wave and S21 is the S-parameter for the transmitted wave. For convenience, two variables for the S-parameters on a dB scale, S11dB and S21dB, are also defined using the following relation:

$$S_{11\text{dB}} = 20\log_{10}(|S_{11}|)$$

The model and physics interface names also appear in front of the variable names so they can vary. The S-parameter variables are added to the predefined quantities in appropriate plot lists.

Port Sweeps/Manual Terminal Sweeps and Touchstone Export

The [Port Sweep Settings](#) in the Magnetic Fields interface, [Input Sweep Settings](#) in the Magnetic and Electric Fields interface, [Manual Terminal Sweep Settings](#) section in the Electrostatics interface and the [Manual Terminal Sweep Settings](#) section in the Electric Currents interface describe how to cycle through the ports and terminals, compute the entire S-matrix and export it to a Touchstone file.

Connecting to Electrical Circuits

In this section:

- [About Connecting Electrical Circuits to Physics Interfaces](#)
- [Connecting Electrical Circuits Using Predefined Couplings](#)
- [Connecting Electrical Circuits by User-Defined Couplings](#)
- [Solving](#)
- [Postprocessing](#)



Inductor in an Amplifier Circuit: Application Library path
ACDC_Module/Inductive_Devices_and_Coils/inductor_in_circuit

About Connecting Electrical Circuits to Physics Interfaces

This section describes the various ways electrical circuits can be connected to other physics interfaces in COMSOL Multiphysics. If you are not familiar with circuit modeling, it is recommended that you review the [Theory for the Electrical Circuit Interface](#).

In general electrical circuits connect to other physics interfaces via one or more of three special circuit features:

- [External I vs. U](#)
- [External U vs. I](#)
- [External I-Terminal](#)

These features either accept a voltage measurement from the connecting noncircuit physics interface and return a current from a or the Electrical Circuit interface or the other way around.



The “External” features are considered “ideal” current or voltage sources by the Electrical Circuit interface. Hence, you cannot connect them directly in parallel (voltage sources) or in series (current sources) with other ideal sources. This results in the error message *The DAE is structurally inconsistent*. A workaround is to provide a suitable parallel or series resistor, which can be tuned to minimize its influence on the results.

Connecting Electrical Circuits Using Predefined Couplings

In addition to these circuit features, interfaces in the AC/DC Module, RF Module, MEMS Module, Plasma Module, and Semiconductor Module (the modules that include the Electrical Circuit interface) also contain features that provide couplings to the Electrical Circuit interface by accepting a voltage or a current from one of the specific circuit features ([External I vs. U](#), [External U vs. I](#), and [External I-Terminal](#)).

This coupling is typically activated when:

- A choice is made in the **Settings** window for the noncircuit physics interface feature, which then announces (that is, includes) the coupling to the Electrical Circuit interface. Its voltage or current is then included to make it visible to the connecting circuit feature.
- A voltage or current that has been announced (that is, included) is selected in a feature node’s **Settings** window.

These circuit connections are supported in Terminals and Coils.

Connecting Electrical Circuits by User-Defined Couplings

A more general way to connect a physics interface to the Electrical Circuit interface is to:

- Apply the voltage or current from the connecting “External” circuit feature as an excitation in the noncircuit physics interface.

- Define your own voltage or current measurement in the noncircuit physics interface using variables, coupling operators and so forth.
- In the **Settings** window for the Electrical Circuit interface feature, selecting the User-defined option and entering the name of the variable or expression using coupling operators defined in the previous step.

DETERMINING A CURRENT OR VOLTAGE VARIABLE NAME

To determine a current or voltage variable name, look at the **Dependent Variables** node under the **Study** node. To do this:

- 1 In the **Model Builder**, right-click the **Study** node and select **Show Default Solver**.
- 2 Expand the **Solver>Dependent Variables** node and click the state node, in this example, **Current through device R1 (comp1.currents)**. The variable name is shown in the **Settings** window for **State**.

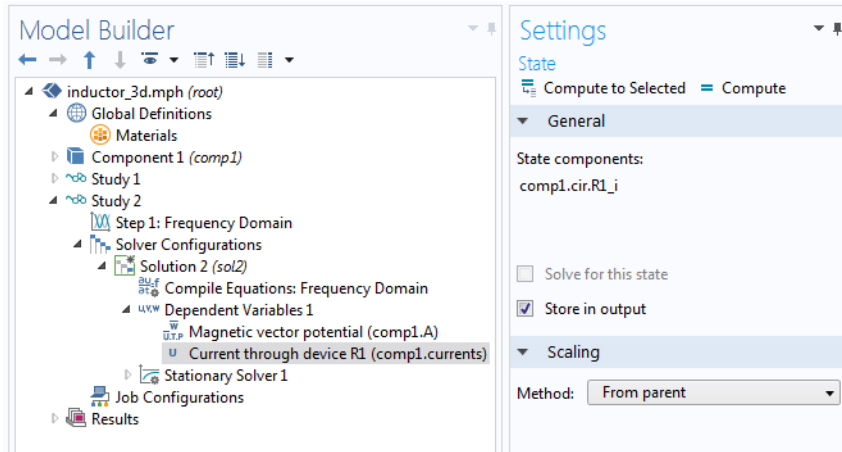

Typically, voltage variables are named `cir.Xn_v` and current variables `cir.Xn_i`, where n is the “External” device number — 1, 2, and so on.

Solving



Some modeling errors lead to the error message *The DAE is structurally inconsistent* being displayed when solving. This error typically occurs from having an open current loop, from connecting voltage sources in parallel, or connecting current sources in series.

In this respect, the predefined coupling features are also treated as (ideal) voltage or current sources. The remedy is to close current loops and to connect resistors in series with voltage sources or in parallel with current sources.

Postprocessing

The Electrical Circuits interface, unlike most of the other physics interfaces, solves for a relatively large number of global dependent variables (such as voltages and currents), instead of solving for a few space-varying fields (such as temperature or displacement). For this reason, the Electrical Circuit interface does not provide default plots when computing a study.

The physics interface defines a number of variables that can be used in postprocessing. All variables defined by the Electrical Circuit interface are of a global scope, and can be evaluated in a **Global Evaluation** node (under **Derived Values**). In addition, the time evolution or dependency on a parameter can be plotted in a **Global** plot (under a **ID Plot Group** node).

The physics interface defines a Node voltage variable for each electrical node in the circuit, with name `cir.v_name`, where `cir` is the physics interface Label and `<name>` is the node Name. For each two-pin component, the physics interface also defines variables containing the voltage across it and the current flowing through it.



In the *COMSOL Multiphysics Reference Manual*:

- [Derived Values, Evaluation Groups, and Tables and Global Evaluation](#)
 - [Plot Groups and Plots and Global](#)
-

SPICE Import and Export

SPICE Import

The circuit definition in COMSOL Multiphysics adheres to the SPICE format developed at the University of California, Berkeley (Ref. 1). SPICE netlists can be imported and the corresponding circuit nodes are generated in the COMSOL Multiphysics model. Most circuit simulators can export to this format or some version of it.

The Electrical Circuit interface supports the following device models:

TABLE 3-2: SUPPORTED SPICE DEVICE MODELS

STATEMENT	DEVICE MODEL
R	Resistor
C	Capacitor
L	Inductor
V	Voltage Source
I	Current Source
E	Voltage-Controlled Voltage Source
F	Current-Controlled Current Source
G	Voltage-Controlled Current Source
H	Current-Controlled Voltage Source
D	Diode
Q	NPN BJT and PNP BJT
M	n-Channel MOSFET and p-Channel MOSFET
X	Subcircuit Instance

Statements corresponding to multiple devices are resolved by parsing the associated `.model` statement. The physics interface also supports the `.subckt` statement, which is represented in COMSOL by a [Subcircuit Definition](#) node, and the `.include` statement. SPICE commands are interpreted case-insensitively. The statement defining each device is also interpreted as the **Device name**.

According to SPICE specification, the first line in the netlist file is assumed to be the title of the netlist and it is ignored by the parser.

SPICE Export

The **SPICE Export** functionality creates a SPICE netlist file containing a description of the circuit represented by the physics interface. This functionality can be accessed from the physics interface context menu (right-click the physics interface node and select **Export SPICE Netlist**). After specifying a file name, the circuit is exported and messages from the export process display in the **Messages** window. During the export process, a series of operations are performed:

- In order to avoid conflicts, each component must be identified by a unique **Device name**. If one or more components have the same device name, the export operation fails and an error message is displayed. All characters in a **Device name** that are not letters, digits or underscores are replaced by underscores.
- According to the SPICE specification, each circuit must have a node with name 0, which is assumed to be the only ground node. When exporting a circuit, any node with name 0 that is not connected to a **Ground** component is exported with a different node name. All nodes that are connected to a Ground components are exported as a merged node with name 0. The Messages window shows a log message if these operations are performed, showing the name of the renamed or merged nodes.
- All characters in node names that are not letters, digits or underscores are replaced by underscores.
- Some components (most notably, the **External** components used to couple to other physics interfaces) cannot be exported to a SPICE netlist. These components are ignored during the export process, and a message is shown in the Messages window. Note that this can change the exported circuit, since some components are then missing.
- Subcircuit definitions are added as `.subckt` statements in the netlist. Semiconductor devices (such as MOSFETs, BJTs, and diodes) are exported as a SPICE device with a corresponding `.model` statement.

The title of the exported netlist file is the model's filename, and the time, date, and version of COMSOL Multiphysics is added as a comment in the netlist file.

Reference

1. <http://bwrc.eecs.berkeley.edu/Classes/IcBook/SPICE/>

Electric Field Interfaces

This chapter summarizes the functionality of the electric field interfaces found under the **Electric Fields and Currents** folder under the **AC/DC** branch (). The AC/DC Module enhances the Electrostatics and Electric Currents interfaces included with the basic COMSOL Multiphysics® license.

In this chapter:

- [The Electrostatics Interface](#)
- [The Electrostatics, Boundary Elements Interface](#)
- [The Electric Currents Interface](#)
- [The Electric Currents in Shells Interface](#)
- [The Electric Currents in Layered Shells Interface](#)
- [The Electric Currents, Single Layer Shell Interface](#)
- [The Electric Currents, Layered Shell Interface](#)
- [Theory for the Electrostatics Interface](#)
- [Theory for the Electric Currents Interface](#)
- [Theory for the Electric Currents, Single Layer Shell Interface](#)

The Electrostatics Interface

The **Electrostatics (es)** interface (), found under the **AC/DC>Electric Fields and Currents** branch when adding a physics interface, is used to compute the electric field, electric displacement field, and potential distributions in dielectrics under conditions where the electric charge distribution is explicitly prescribed. The formulation is stationary except for use together with other physics interfaces. Eigenfrequency, frequency-domain, small-signal analysis, and time-domain modeling are supported in all space dimensions.

The physics interface solves Gauss' Law for the electric field using the scalar electric potential as the dependent variable.

Charge Conservation is the main node, which adds the equation for the electric potential and has a Settings window for defining the constitutive relation for the electric displacement field and its associated properties such as the relative permittivity.

When this physics interface is added, these default nodes are also added to the **Model Builder — Charge Conservation, Zero Charge** (the default boundary condition), and **Initial Values**. Then, from the **Physics** toolbar, add other nodes that implement, for example, boundary conditions and space charges. You can also right-click **Electrostatics** to select physics features from the context menu.

Physics-Controlled Mesh

The physics-controlled mesh is controlled from the **Mesh** node's **Settings** window (if the **Sequence type** is **Physics-controlled mesh**). There, in the table in the **Physics-Controlled Mesh** section, find the physics interface in the **Contributor** column and select or clear the check box in the **Use** column on the same table row for enabling (the default) or disabling contributions from the physics interface to the physics-controlled mesh.

Information from the physics, such as the presence of an infinite elements domain or periodic condition, will be used to automatically set up an appropriate mesh sequence.



In the *COMSOL Multiphysics Reference Manual* see the **Physics-Controlled Mesh** section for more information about how to define the physics-controlled mesh.

SETTINGS

The **Label** is the default physics interface name.

The **Name** is used primarily as a scope prefix for variables defined by the physics interface. Refer to such physics interface variables in expressions using the pattern <name>.<variable_name>. In order to distinguish between variables belonging to different physics interfaces, the name string must be unique. Only letters, numbers, and underscores (_) are permitted in the **Name** field. The first character must be a letter.

The default **Name** (for the first physics interface in the model) is **es**.

CROSS-SECTION AREA (1D COMPONENTS)

For 1D components, enter a default value for the **Cross-section area** A (SI unit: m^2). The default value of 1 is typically not representative for a thin domain. Instead it describes a unit thickness that makes the 1D equation identical to the equation used for 3D components. See also [Change Cross Section](#).

THICKNESS (2D COMPONENTS)

For 2D components, enter a default value for the **Out-of-plane thickness** d (SI unit: m). The default value of 1 is typically not representative for a thin dielectric medium, for example. Instead it describes a unit thickness that makes the 2D equation identical to the equation used for 3D components. See also [Change Thickness \(Out-of-Plane\)](#).

MANUAL TERMINAL SWEEP SETTINGS

Enter a **Reference impedance** Z_{ref} (SI unit: Ω). The default is 50 Ω .

Select the **Activate manual terminal sweep** check box to switch on the sweep and invoke a parametric sweep over the terminals. Enter a **Sweep parameter name** to assign a specific name to the variable that controls the terminal number solved for during the sweep. The **Sweep parameter name** must also be declared as a model parameter. The default is PortName.

The generated lumped parameters are in the form of capacitance matrix elements. The terminal settings must consistently be of either fixed voltage or fixed charge type.

The lumped parameters are subject to **Touchstone file export**. Enter a file path or **Browse** for a file. Select a **Parameter format (value pairs)** for the Touchstone export — **Magnitude and angle (MA)** (the default), **Magnitude in dB and angle (DB)**, or **Real and imaginary parts (RI)**. Select an option from the **If file exists** list — **Overwrite** or **Create new**. Create new is useful when the model is solved multiple times with different settings. Select a **Parameter to export: Z** (the default), **Y**, or **S**.

From the **Home** toolbar add a **Parameters** node and enter the chosen name and assign to it a temporary **Expression** of unity into the **Parameters** table. You can also right-click **Global Definitions** to add the node.



Only a temporary expression needs to be entered at this stage. During the analysis process, the solver assigns a proper value to this parameter. The generated lumped parameters are in the form of capacitance matrix elements. The terminal settings must consistently be of either fixed voltage or fixed charge type.



For most applications it is simpler to sweep over terminals using the Stationary Source Sweep study step. See [Stationary Source Sweep](#) in the *COMSOL Multiphysics Reference Manual* and (for more details) [Stationary Source Sweep](#) in the *AC/DC Module User's Guide*.

DEPENDENT VARIABLES

The dependent variable is the **Electric potential** V . You can change its name, which changes both the field name and the variable name. If the new name coincides with the name of another electric potential field in the model, the physics interfaces shares degrees of freedom. The new name must not coincide with the name of a field of another type or with a component name belonging to some other field.

DISCRETIZATION



In the *COMSOL Multiphysics Reference Manual*, see [Table 2-4](#) for links to common sections and [Table 2-5](#) to common feature nodes. You can also search for information: press F1 to open the **Help** window or Ctrl+F1 to open the **Documentation** window.



- [Domain, Boundary, Edge, Point, and Pair Nodes for the Electrostatics Interface](#)
- [Theory for the Electrostatics Interface](#)



Electric Sensor: Application Library path
COMSOL_Multiphysics/Electromagnetics/electric_sensor

Domain, Boundary, Edge, Point, and Pair Nodes for the Electrostatics Interface

The Electrostatics interface has these domain, boundary, edge, point, and pair nodes available.

ABOUT THE BOUNDARY CONDITIONS

The relevant physics interface condition at interfaces between different media is

$$\mathbf{n}_2 \cdot (\mathbf{D}_1 - \mathbf{D}_2) = \rho_s$$

In the absence of surface charges, this condition is fulfilled by the natural boundary condition

$$\mathbf{n} \cdot [(\epsilon_0 \nabla V - \mathbf{P})_1 - (\epsilon_0 \nabla V - \mathbf{P})_2] = -\mathbf{n} \cdot (\mathbf{D}_1 - \mathbf{D}_2) = 0$$

AVAILABLE NODES

These nodes, listed in alphabetical order, are available from the **Physics** ribbon toolbar (Windows users), **Physics** context menu (Mac or Linux users), or right-click to access the context menu (all users). Also see [Table 4-1](#) for a list of interior and exterior boundary conditions, including edge, point, and pair availability.



In general, to add a node, go to the **Physics** toolbar no matter what operating system you are using. Subnodes are available by clicking the parent node and selecting it from the **Attributes** menu.

- Archie’s Law
- Change Cross Section
- Change Thickness (Out-of-Plane)
- Charge Conservation
- Charge Conservation, Piezoelectric¹
- Dielectric Shielding
- Distributed Capacitance
- Effective Medium
- Electric Displacement Field
- Electric Potential
- Electrostatic Point Dipole
- External Surface Charge Accumulation
- Floating Potential
- Force Calculation
- Ground
- Initial Values
- Line Charge
- Line Charge (on Axis)
- Line Charge (Out-of-Plane)
- Periodic Condition
- Point Charge
- Point Charge (on Axis)
- Space Charge Density
- Surface Charge Density
- Terminal
- Thin Low Permittivity Gap
- Zero Charge (the default boundary condition)

¹ This feature is available with the Piezoelectricity interface, which requires the Acoustics Module, MEMS Module, or the Structural Mechanics Module.

Table 4-1 lists the interior and exterior boundary conditions available with this physics interface. It also includes edge, point, and pair availability.

TABLE 4-1: INTERIOR AND EXTERIOR BOUNDARY CONDITIONS (INCLUDING EDGE, POINT, AND PAIR AVAILABILITY) FOR THE ELECTROSTATICS INTERFACE

NODE	INTERIOR	EXTERIOR	ALSO AVAILABLE FOR
Change Cross Section	x	x	pairs
Change Thickness (Out-of-Plane)	x	x	pairs
Dielectric Shielding	x	x	pairs
Distributed Capacitance	x	x	pairs
Electric Displacement Field	x	x	pairs
Electric Potential	x	x	edges, points, and pairs
External Surface Charge Accumulation		x	pairs
Floating Potential	x	x	pairs
Ground	x	x	edges, points, and pairs

TABLE 4-1: INTERIOR AND EXTERIOR BOUNDARY CONDITIONS (INCLUDING EDGE, POINT, AND PAIR AVAILABILITY) FOR THE ELECTROSTATICS INTERFACE

NODE	INTERIOR	EXTERIOR	ALSO AVAILABLE FOR
Periodic Condition		x	not applicable
Surface Charge Density	x	x	pairs
Terminal	x	x	domains
Thin Low Permittivity Gap	x		not applicable
Zero Charge (the default)	x	x	pairs



For axisymmetric components, COMSOL Multiphysics takes the axial symmetry boundaries (at $r = 0$) into account and automatically adds an **Axial Symmetry** node to the model that is valid on the axial symmetry boundaries only. There are also **Line Charge (on Axis)** and **Point Charge (on Axis)** available.



In the *COMSOL Multiphysics Reference Manual*, see [Table 2-4](#) for links to common sections and [Table 2-5](#) to common feature nodes. You can also search for information: press F1 to open the **Help** window or Ctrl+F1 to open the **Documentation** window.

Charge Conservation

The **Charge Conservation** node adds the equations for charge conservation according to Gauss' law for the electric displacement field. It provides an interface for defining the constitutive relation and its associated properties such as the relative permittivity.

MATERIAL TYPE

The **Material type** setting decides how materials behave and how material properties are interpreted when the mesh is deformed. Select **Solid** for materials whose properties change as functions of material strain, material orientation, and other variables evaluated in a material reference configuration (material frame). Select **Nonsolid** for materials whose properties are defined only as functions of the current local state at each point in the spatial frame, and for which no unique material reference configuration can be defined. Select **From material** to pick up the corresponding setting from the domain material on each domain.

CONSTITUTIVE RELATION D-E

Select a **Dielectric model** to describe the macroscopic properties of the medium (relating the electric displacement \mathbf{D} with the electric field \mathbf{E}) and the applicable material properties, such as the relative permittivity. Select:

- **Relative permittivity** (the default) to use the constitutive relation $\mathbf{D} = \epsilon_0 \epsilon_r \mathbf{E}$. Then the default is to take the **Relative permittivity** ϵ_r (dimensionless) values **From material**. For **User defined**, select **Isotropic**, **Diagonal**, **Symmetric**, or **Full** and enter values or expressions in the field or matrix. The default is 1. If **Effective medium** is selected, the [Effective Medium](#) subnode is available from the context menu (right-click the parent node) as well as from the **Physics** toolbar, **Attributes** menu.
- **Polarization** to use the constitutive relation $\mathbf{D} = \epsilon_0 \mathbf{E} + \mathbf{P}$. Then enter the components based on space dimension for the **Polarization** vector \mathbf{P} (SI unit: C/m²). The defaults are 0 C/m².
- **Remanent electric displacement** to use constitutive relation $\mathbf{D} = \epsilon_0 \epsilon_r \mathbf{E} + \mathbf{D}_r$, where \mathbf{D}_r is the remanent displacement (the displacement when no electric field is present). Then the default is to take the **Relative permittivity** ϵ_r (dimensionless) values **From material**. For **User defined**, select **Isotropic**, **Diagonal**, **Symmetric**, or **Full** and enter values or expressions in the field or matrix. Then enter the components based on space dimension for the **Remanent electric displacement** \mathbf{D}_r (SI unit: C/m²). The defaults are 0 C/m².

Conduction Loss (Time-Harmonic)



This feature requires the Acoustics Module, MEMS Module, or the Structural Mechanics Module. See the individual documentation for information.

The **Conduction Loss (Time-Harmonic)** subnode allows you to model possible conductive losses in a dielectric material. The effect is only active in a Eigenfrequency or Frequency response study.

CONDUCTION CURRENT

By default, the **Electrical conductivity** σ for the media is defined **From material**. You can also select **User defined** or **Linearized resistivity**.

- For **User defined** select **Isotropic**, **Diagonal**, **Symmetric**, or **Full** depending on the characteristics of the electrical conductivity, and then enter values or expressions for the **Electrical conductivity** σ in the field or matrix.
- For **Linearized resistivity** the default **Reference temperature** T_{ref} and **Resistivity temperature coefficient** α , and **Reference resistivity** ρ_0 are taken **From material**, which means that the values are taken from the domain (or boundary) material. T is the current temperature, which can be a value that is specified as a model input or the temperature from a heat transfer interface. The definition of the temperature field appears in the **Model Inputs** section.

LOCATION IN USER INTERFACE

Context Menus

Electrostatics>Charge Conservation>Conduction Loss (Time-Harmonic)

Ribbon

Physics tab with **Charge Conservation** node selected in the model tree:

Attributes>Conduction Loss (Time-Harmonic)

Initial Values

The **Initial Values** node adds an initial value for the electric potential V that can serve as an initial condition for a transient simulation or as an initial guess for a nonlinear solver.

INITIAL VALUES

Enter a value or expression for the initial value of the **Electric potential** V (SI unit: V). The default value is 0 V.

Space Charge Density

The **Space Charge Density** node adds a space charge density ρ , which appears on the right-hand side of the equation that the physics interface defines.

SPACE CHARGE DENSITY

Enter a value or expression for the **Space charge density** ρ_v (SI unit: C/m³). The default is 0 C/m³.

Force Calculation

Use the **Force Calculation** node to define globally available force and torque variables for the selected domains. **Force Calculation** is also available and defined here for the Magnetic Fields, Magnetic and Electric Fields, and Magnetic Field Formulation interfaces.

FORCE CALCULATION

Enter a **Force name**, which is then appended to global variables. The method used to compute forces and torques is integration of the Maxwell's stress tensor over the exterior surfaces of the set of domains. This feature also gives access to the normal component of the Maxwell stress tensor on the external surfaces. For the Magnetic and Electric Fields and Magnetic Fields interfaces, the force calculation includes both electric and magnetic forces. The computed force is made available as a global vector variable with name `es.Force<component>_<force name>`.

Enter a direction vector for the **Torque axis** \mathbf{r}_{ax} and coordinates for the **Torque rotation point** \mathbf{r}_0 . A torque calculation about a given point (**Torque rotation point**) is made and defined as a global vector variable, `es.T<component>_<force name>`. The resulting torque component parallel to the given **Torque axis** is given as a global scalar variable, typically `es.Tax_<force name>`.

In frequency domain studies, the cycle-averaged force and torque variables are also defined, with names `es.Forceav<component>_<force name>`, `es.Tav<component>_<force name>` and `es.Taxav_<force name>`. The variables described are still defined and represent the instantaneous force and torque.



In small-signal analysis studies, no cycle-average variables are defined. Use the additional plot settings for the Harmonic Perturbation on the instantaneous variables to compute the quantities of interest. See [Harmonic Perturbation, Prestressed Analysis, and Small-Signal Analysis](#) in the *COMSOL Multiphysics Reference Manual*.



For more information on calculation of forces and torques, see [Force and Torque Computations](#).

ADVANCED SETTINGS

To display this section, click the **Show More Options** button () and select **Advanced Physics Options** in the **Show More Options** dialog box.

The **Compute both instantaneous and cycle-averaged variables in frequency domain** check box is selected by default. The check box controls which variables are defined by the Force Calculation feature in frequency-domain studies. When selected (the default setting in new models), the variables are defined as described above. This check box selected by default for backward compatibility. If the check box is cleared, only the cycle-averaged variables are computed, replicating the behavior of the Force Calculation feature in version 4.3 and earlier. The check box is cleared in existing Force Calculation features when opening models created in version 4.3 and earlier.

Zero Charge

The **Zero Charge** node adds the condition that there is zero charge on the boundary so that $\mathbf{n} \cdot \mathbf{D} = 0$. This boundary condition is also applicable at symmetry boundaries where the potential is known to be symmetric with respect to the boundary. This is the default boundary condition at exterior boundaries. At interior boundaries, it means that no displacement field can penetrate the boundary and that the electric potential is discontinuous across the boundary.

Ground

The **Ground** node implements ground (zero potential) as the boundary condition $V = 0$.

Ground means that there is a zero potential on the boundary. This boundary condition is also applicable at symmetry boundaries where the potential is known to be antisymmetric with respect to the boundary.

For some physics interfaces, also select additional **Ground** nodes from the **Edges** (3D components) or **Points** (2D and 3D components) submenus. For 2D axisymmetric components, it can be applied on the Symmetry axis.

BOUNDARY, EDGE, OR POINT SELECTION



Beware that constraining the potential on edges or points in 3D or on points in 2D usually yields a current outflow that is mesh dependent.

CONSTRAINT SETTINGS

To display this section, click the **Show More Options** button () and select **Advanced Physics Options** in the **Show More Options** dialog box.

Electric Potential

The **Electric Potential** node provides an electric potential V_0 as the boundary condition $V = V_0$.

Because the electric potential is being solved for in the physics interface, the value of the potential is typically defined at some part of the geometry. For some physics interfaces, also select additional **Electric Potential** nodes from the **Edges** (3D components) or **Points** (2D and 3D components) submenus. For 2D axisymmetric components, it can be applied on the symmetry axis.

BOUNDARY, EDGE, OR POINT SELECTION



Beware that constraining the potential on edges or points in 3D or on points in 2D usually yields a current outflow that is mesh dependent.

ELECTRIC POTENTIAL

Enter the value or expression for the **Electric potential** V_0 (SI unit: V). The default is 0 V.

CONSTRAINT SETTINGS

To display this section, click the **Show More Options** button () and select **Advanced Physics Options** in the **Show More Options** dialog box.

Surface Charge Density

The **Surface Charge Density** node provides the following surface-charge boundary condition for exterior boundaries (left) and interior boundaries (right):

$$-\mathbf{n} \cdot \mathbf{D} = \rho_s, \quad \mathbf{n} \cdot (\mathbf{D}_1 - \mathbf{D}_2) = \rho_s$$

Specify the surface charge density ρ_s at an outer boundary or at an interior boundary between two nonconducting media.

Add a contribution as a **Harmonic Perturbation** by right-clicking the parent node or click **Harmonic Perturbation** on the **Physics** toolbar. For more information, see [Harmonic Perturbation — Exclusive and Contributing Nodes](#) in the *COMSOL Multiphysics Reference Manual*.

SURFACE CHARGE DENSITY

Enter the value or expression for the **Surface charge density** ρ_s (SI unit: C/m²).

External Surface Charge Accumulation

The **External Surface Charge Accumulation** node implements the boundary condition

$$-\mathbf{n} \cdot \mathbf{D} = \rho_s$$

where ρ_s is the solution of the following distributed ODE on the boundary:

$$\frac{d\rho_s}{dt} = \mathbf{n} \cdot \mathbf{J}_i + \mathbf{n} \cdot \mathbf{J}_e$$

where $\mathbf{n} \cdot \mathbf{J}_i$ is the normal component of the total ion current density on the wall and $\mathbf{n} \cdot \mathbf{J}_e$ is the normal component of the total electron current density on the wall, which are feature inputs.

MATERIAL TYPE

The **Material type** setting decides how materials behave and how material properties are interpreted when the mesh is deformed. Select **Solid** for materials whose properties change as functions of material strain, material orientation, and other variables evaluated in a material reference configuration (material frame). Select **Nonsolid** for materials whose properties are defined only as functions of the current local state at each point in the spatial frame, and for which no unique material reference configuration can be defined. Select **From material** to pick up the corresponding setting from the domain material on each domain.

EXTERNAL SURFACE CHARGE ACCUMULATION

Enter values or expressions for the **Normal ion current density** $\mathbf{n} \cdot \mathbf{J}_i$ (SI unit: A/m²) and the **Normal electron current density** $\mathbf{n} \cdot \mathbf{J}_e$ (SI unit: A/m²).

Electric Displacement Field

The **Electric Displacement Field** node adds the following electric-displacement boundary condition:

$$\mathbf{n} \cdot \mathbf{D} = \mathbf{n} \cdot \mathbf{D}_0$$

It specifies the normal component of the electric displacement field at a boundary.

ELECTRIC DISPLACEMENT FIELD

Enter the coordinates of the **Boundary electric displacement field \mathbf{D}_0** (SI unit: C/m²).

Periodic Condition

The **Periodic Condition** node defines periodicity or antiperiodicity between two boundaries. If required, activate periodic conditions on more than two boundaries, in which case the Periodic Condition tries to identify two separate surfaces that can each consist of several connected boundaries. For more complex geometries, it might be necessary to use the **Destination Selection** subnode. With this subnode the boundaries which constitute the source and destination surfaces can be manually specified. The **Destination Selection** subnode is available from the context menu (right-click the parent node) as well as from the **Physics** toolbar, **Attributes** menu.



When this feature is used in conjunction with a [Sector Symmetry](#) feature on connected boundaries, wherever the sector symmetry boundaries connect with the periodic boundaries, the same periodic condition feature cannot be used on both sides. At least two periodic condition features are required for the model to compute correctly.

BOUNDARY SELECTION

When using nonconforming meshes on the source and destination of a periodic boundary pair, for numerical stability, a finer mesh should be applied on the destination side. Use conforming meshes if possible.

PERIODIC CONDITION

Select a **Type of periodicity** — **Continuity** (the default), **Antiperiodicity**, or **Floquet periodicity**. Select:

- **Continuity** to make the electric potential periodic (equal on the source and destination).
- **Antiperiodicity** to make it antiperiodic.
- **Floquet periodicity** (only available with products supporting piezoelectric modeling). Specify the components of the **k-vector for Floquet periodicity** \mathbf{k}_F (SI unit: rad/m).

CONSTRAINT SETTINGS

To display this section, click the **Show More Options** button () and select **Advanced Physics Options** in the **Show More Options** dialog box.

For information about the Orientation of Source section, see [Orientation of Source and Destination](#) in the *COMSOL Multiphysics Reference Manual*.

Thin Low Permittivity Gap

Use the **Thin Low Permittivity Gap** node

$$\mathbf{n} \cdot \mathbf{D}_1 = \frac{\epsilon_0 \epsilon_r}{d} (V_1 - V_2)$$

$$\mathbf{n} \cdot \mathbf{D}_2 = \frac{\epsilon_0 \epsilon_r}{d} (V_2 - V_1)$$

to model a thin gap of a material with a small permittivity compared to the adjacent domains. The layer has the thickness d and the relative permittivity ϵ_r . The indices 1 and 2 refer to the two sides of the boundary.

THIN LOW PERMITTIVITY GAP

The default is to take the **Relative permittivity** ϵ_r (dimensionless) values **From material**. For **User defined**, enter a different value or expression. Enter a **Thickness** d (SI unit: m). The default is 5 mm.



Thin Low Permittivity Gap Comparison: Application Library path
ACDC_Module/Capacitive_Devices/thin_low_permittivity_gap_comparison

Dielectric Shielding

The **Dielectric Shielding** node adds dielectric shielding as a boundary condition. It describes a thin layer with thickness d_s and a bulk relative permittivity ϵ_r that shields the electric field:

$$\mathbf{n} \cdot \mathbf{D} = -\nabla_t \cdot \epsilon_0 \epsilon_{rs} d_s \nabla_t V$$

Use this boundary condition when approximating a thin domain with a boundary to reduce the number of mesh elements.

MATERIAL TYPE

The **Material type** setting decides how materials behave and how material properties are interpreted when the mesh is deformed. Select **Solid** for materials whose properties change as functions of material strain, material orientation and other variables evaluated in a material reference configuration (material frame). Select **Nonsolid** for materials whose properties are defined only as functions of the current local state at each point in the spatial frame, and for which no unique material reference configuration can be defined. Select **From material** to pick up the corresponding setting from the domain material on each domain.

ELECTRIC SHIELDING

The default is to take the **Relative permittivity** ϵ_r (dimensionless) values **From material**. It takes it from the adjacent domains if not explicitly defined. For **User defined** select **Isotropic**, **Diagonal**, **Symmetric**, or **Full** and enter values or expressions in the field or matrix. Enter a **Surface thickness** d_s (SI unit: m) of the shielding. The default is 1 m.



For a dielectric shielding example, see *Dielectric Shielding Comparison*:
Application Library path
ACDC_Module/Capacitive_Devices/dielectric_shielding_comparison.

Terminal

The **Terminal** node provides a boundary or domain condition for connection to external circuits, to transmission lines, or with a specified voltage or charge. By specifying zero charge, a floating potential condition is obtained.



In most cases, it is not recommended to include the interior of good conductors in the simulation. When using the **Terminal** on the domain level, the interior unknowns for the electric potential are automatically replaced by a single constant, thus avoiding numerical problems arising from a very high material contrast. If one instead uses the **Terminal** on the boundary level, it is recommended to exclude the interior of the associated conductor from the domain selection for the main Electrostatics node.

The **Terminal** node also enables the computation of the lumped parameters of the system, such as capacitance. See [Lumped Parameters](#).

TERMINAL

Specify the terminal properties. Enter a unique **Terminal name** that will be used to identify the global variables (such as the terminal voltage or current) that are defined by the terminal. The **Terminal name** can contain alphanumeric characters, but it should be numeric when performing terminal sweeps.

Select a **Terminal type** — **Charge** (the default), **Voltage**, **Circuit**, or **Terminated**. Select:

- **Charge** to prescribe the total charge deposited on the terminal boundaries. Enter the total charge Q_0 . The default is 0 C, which corresponds to a uncharged floating electrode.

- **Voltage** to specify a fixed electric potential at the terminal. Enter an electric potential V_0 . The default is 1 V.



To correctly calculate the terminal charge and the corresponding capacitances, if **Voltage** Terminal is used on boundaries between [The Electrostatics Interface](#) and [The Electrostatics, Boundary Elements Interface](#), let the dependent variable for [The Electrostatics, Boundary Elements Interface](#) be the same as the dependent variable for [The Electrostatics Interface](#) and disable [Electric Scalar-Scalar Potential Coupling](#). How to set the name for the dependent variable is described in the [Dependent Variables](#) section. Since the [Electric Scalar-Scalar Potential Coupling](#) is disabled, add manually a Fully Coupled node to the Stationary Solver below the Solution node in the Solver Configurations.

- **Circuit** to specify a terminal connected to an Electrical Circuit physics interface that models an external circuit. The Terminal node provides a current-voltage characteristic to the circuit.



[The Electrical Circuit Interface](#) requires a current from the Terminal, so the **Circuit** terminal type can only be used in Time Dependent or Frequency Domain studies, in which the current can be computed as the time derivative of the charge.

The **Circuit** type cannot be used together with a terminal sweep.

- **Terminated** to connect the terminal to an impedance that might represent a load or a transmission line. When **Terminated** is selected, the scattering parameters (S-parameters) are computed. The **Terminated** setting can only be used in frequency-domain studies.
 - Enter a **Terminal power** P_0 to specify the input power at this terminal from the transmission line. This excitation can be toggled using a port sweep.
 - Select an option from the **Characteristic impedance from** list to define the value of the impedance — **Physics interface** or **User defined**. For **Physics interface** the **Reference impedance** Z_{ref} defined on the **Settings** window for the physics under Sweep Settings is used. For **User defined** enter a specific impedance Z_{ref} for this terminal. The default is 50 Ω .

Initial values

The initial values subsection is used to provide initial values for the internal state variables in the Terminal. These settings can be useful to provide an initial guess to the nonlinear solver or the initial value in a time-dependent study.

The **Initial value for voltage** is available for all Terminal types except Voltage. Enter an **Initial value for voltage** V_{init} .

The **Initial value for charge** is available for the Circuit excitation. It specifies the initial charge on the terminal when the circuit is connected. Enter an **Initial value for charge** Q_{init} .

CONSTRAINT SETTINGS

To display this section, click the **Show More Options** button () and select **Advanced Physics Options** in the **Show More Options** dialog box.



[Studies and Solvers](#) in the *COMSOL Multiphysics Reference Manual*



For a voltage terminal type example, see *Dielectric Shielding Comparison*: Application Library path
ACDC_Module/Capacitive_Devices/dielectric_shielding_comparison.

Floating Potential

The **Floating Potential** node is used when modeling a metallic electrode at floating potential. It applies a constant voltage V_0 on the boundary (for domain features, this is the boundary enclosing the selected domain), such that the total normal electric displacement field \mathbf{D} equals a specific charge Q_0 :

$$V = V_0$$
$$\int_{\partial\Omega} (\mathbf{D} \cdot \mathbf{n}) dS = Q_0,$$

where Ω represents the boundary and \mathbf{n} refers to the surface normal. The constant boundary voltage implies the tangential electric field equals zero; the electric field will be perpendicular to the boundary:

$$-\nabla_t V = \mathbf{E}_t = 0$$

$$\mathbf{n} \times \mathbf{E} = 0.$$

In case of $Q_0 = 0$ (the default case), the boundary will behave as an unconnected, neutrally charged, good conductor under electrostatic conditions (a floating equipotential). Although locally the displacement field may vary, the total electric displacement field entering or leaving the boundary equals zero.

If the floating potential touches a point, boundary or domain feature that is not floating (a **Terminal** or **Ground** feature), the floating potential will acquire that feature's potential. If the floating potential is set to a certain charge, or connected to a circuit, it behaves like a terminal.

FLOATING POTENTIAL

The **Floating potential identifier** text area shows the unique identifier for the floating potential feature. It is used to identify the global variables created by the node, such as the voltage. The **Floating potential group** check box on the **Settings** window for **Floating Potential** controls how potentials are assigned to boundary segments in the feature's boundary selection. If this check box is not selected, a single potential is applied to all boundaries in the selection. If the check box is selected, each group of contiguous boundaries in the selection is given a unique potential. This simplifies the setup of models with many floating electrodes. The values of the potential at each group of boundaries are then made available in postprocessing, collected in a vector variable.

The following options are not available if the **Floating potential group** check box is selected. Select a specification for the **Electric charge** — choose **User defined** to specify a total **Charge** Q_0 deposited on the surface. Select **Circuit** to connect the floating potential to an Electrical Circuit.



The **Electrical Circuit Interface** requires a current from the Floating Potential, so the **Circuit** terminal type can only be used in Time Dependent or Frequency Domain studies, in which the current can be computed as the time derivative of the charge.

Initial Values

The initial values subsection is used to provide initial values for the internal state variables in the Floating potential. These settings can be useful to provide an initial guess to the nonlinear solver or the initial value in a time-dependent study.

Enter an **Initial value for voltage** V_{init} .

The **Initial value for charge** is available for the Circuit excitation. It specifies the initial charge on the floating potential when the circuit is connected. Enter an **Initial value for charge** Q_{init} .

CONSTRAINT SETTINGS

To display this section, click the **Show More Options** button () and select **Advanced Physics Options** in the **Show More Options** dialog box.



Settings and Properties Windows for Feature Nodes in the *COMSOL Multiphysics Reference Manual*

Distributed Capacitance

The **Distributed Capacitance** node adds a distributed capacitance boundary condition according to the following equations for exterior boundaries (left) and interior boundaries (right):

$$-\mathbf{n} \cdot \mathbf{D} = \epsilon_0 \epsilon_r \frac{V_{\text{ref}} - V}{d_s} \quad \mathbf{n} \cdot (\mathbf{D}_1 - \mathbf{D}_2) = \epsilon_0 \epsilon_r \frac{V_{\text{ref}} - V}{d_s}$$

Use this boundary condition to model a thin sheet or film of a dielectric material. The sheet has the relative permittivity ϵ_r and the surface thickness d_s , and it is connected to the reference potential V_{ref} .

DISTRIBUTED CAPACITANCE

Enter the values or expressions for **Relative permittivity** ϵ_r (dimensionless), **Surface thickness** d_s (SI unit: m), and **Reference potential** V_{ref} . The default value for the surface thickness is 10^{-3} m (1 mm) and 0 V for the reference potential.

Line Charge

For 3D components, use the **Line Charge** node to specify line charges along the edges of a geometry. Add a contribution as a **Harmonic Perturbation** by right-clicking the parent node or clicking **Harmonic Perturbation** on the **Physics** toolbar. For more information see [Harmonic Perturbation — Exclusive and Contributing Nodes](#) in the *COMSOL Multiphysics Reference Manual*.

EDGE SELECTION



Beware that constraining the potential on edges usually yields a current outflow that is mesh dependent.

LINE CHARGE

Enter a value or expression to apply a **Line charge** Q_L (SI unit: C/m). This source represents electric charge per unit length and the default is 0 C/m.



[Line Charge \(on Axis\)](#) and [Line Charge \(Out-of-Plane\)](#)

Line Charge (on Axis)

For 2D axisymmetric components, use the **Line Charge (on Axis)** node to specify line charges along the symmetry axis.

Add a contribution as a **Harmonic Perturbation** by right-clicking the parent node or click **Harmonic Perturbation** on the **Physics** toolbar. For more information see [Harmonic Perturbation — Exclusive and Contributing Nodes](#) in the *COMSOL Multiphysics Reference Manual*.

LINE CHARGE (ON AXIS)

Enter a value or expression to apply a **Line charge** Q_L (SI unit: C/m). This source represents electric charge per unit length and the default is 0 C/m.



[Line Charge](#) and [Line Charge \(Out-of-Plane\)](#)

Line Charge (Out-of-Plane)

For 2D and 2D axisymmetric components, points are selected and this is the same as a line out-of-plane.

Add a contribution as a **Harmonic Perturbation** by right-clicking the parent node or clicking **Harmonic Perturbation** on the **Physics** toolbar. For more information see

[Harmonic Perturbation — Exclusive and Contributing Nodes](#) in the *COMSOL Multiphysics Reference Manual*.

Use the **Line Charge (Out-of-Plane)** node to specify line charges along the points of a geometry for 2D and 2D axisymmetric components.

POINT SELECTION



Beware that constraining the potential on points usually yields a current outflow that is mesh dependent.

LINE CHARGE (OUT-OF-PLANE)

Enter a value or expression to apply a **Line charge** Q_L (SI unit: C/m). This source represents electric charge per unit length and the default is 0 C/m.



[Line Charge](#) and [Line Charge \(on Axis\)](#)

Point Charge

The **Point Charge** node adds a point source to 3D components. The point charge represents an electric displacement field flowing out of the point.

Add a contribution as a **Harmonic Perturbation** by right-clicking the parent node or clicking **Harmonic Perturbation** on the **Physics** toolbar. For more information see [Harmonic Perturbation — Exclusive and Contributing Nodes](#) in the *COMSOL Multiphysics Reference Manual*.

POINT SELECTION



Beware that constraining the potential on points usually yields a current outflow that is mesh dependent.

POINT CHARGE

Enter a value or expression to apply a **Point charge** Q_P (SI unit: C) to points. This source represents an electric displacement field flowing out of the point. The default is 0 C.



Point Charge (on Axis) and Line Charge (Out-of-Plane)

Point Charge (on Axis)

The **Point Charge (on Axis)** node adds a point source to 2D axisymmetric components. The point charge represents an electric displacement field flowing out of the point.

Add a contribution as a **Harmonic Perturbation** by right-clicking the parent node or clicking **Harmonic Perturbation** on the **Physics** toolbar. For more information see [Harmonic Perturbation — Exclusive and Contributing Nodes](#) in the *COMSOL Multiphysics Reference Manual*.

POINT SELECTION



Beware that constraining the potential on points usually yields a current outflow that is mesh dependent.

POINT CHARGE (ON AXIS)

Enter a value or expression to apply a **Point charge** Q_P (SI unit: C) to points on an axis. This source represents an electric displacement field flowing out of the point. The default is 0 C.



Point Charge and Line Charge (Out-of-Plane)

Change Cross Section

This node is available with 1D components. This setting overrides the global **Cross-Section Area** setting made in any physics interface that uses this feature. For 2D components, see [Change Thickness \(Out-of-Plane\)](#).

Use the **Change Cross Section** node to set the cross-section area for specific geometric entities.

CHANGE CROSS SECTION

Enter a value or expression for the **Cross-section area** A . The default value of 1 unit length is typically not representative for a thin domain. Instead it describes a unit thickness that makes the 1D equation identical to the equation used for 3D components.

Change Thickness (Out-of-Plane)

This node is available for 2D components. This setting overrides the global **Thickness** setting made in any physics interface that uses this node. For 1D components, see [Change Cross Section](#).

Use the **Change Thickness (Out-of-Plane)** node to set the out-of-plane thickness for specific geometric entities.

CHANGE THICKNESS (OUT-OF-PLANE)

Enter a value or expression for the **Out-of-plane thickness** d (SI unit: m). The default value is, in most cases, 1 unit length, which is typically not representative for a thin domain. Instead it describes a unit thickness that makes the 2D equation identical to the equation used for 3D components.

Charge Conservation, Piezoelectric



This feature is available with the Piezoelectricity interface, which requires the Acoustics Module, MEMS Module, or the Structural Mechanics Module. See the individual documentation for information.

The **Charge Conservation, Piezoelectric** node is normally used together with a **Piezoelectric Effect** multiphysics coupling node and a corresponding **Piezoelectric Material** node in the **Solid Mechanics** interface. The node is added by default to the **Electrostatics** interface when adding a Piezoelectricity interface. It is also available from

the context menu (right-click the **Electrostatics** interface parent node) or from the **Physics** toolbar.



When the **Charge Conservation, Piezoelectric** node is added to the electrostatics interface in the absence of an active **Piezoelectric Effect** multiphysics coupling node, the material behaves similarly to a **Charge Conservation** node, with electric properties corresponding to the relative permittivity entered (see below). The piezoelectric effect is *not* included in the corresponding equation system.

ELECTRIC DISPLACEMENT

If the node is used together with an active **Piezoelectric Effect** multiphysics coupling node, then these settings are locked. Note that if they are unlocked, then the material behaves like a dielectric and *not* a piezoelectric. In this case, the default is to take the **Relative permittivity** ϵ_{rs} (dimensionless) values **From material**. For **User defined**, select **Isotropic, Diagonal, Symmetric, or Full** and enter values or expressions in the field or matrix.

Electrostatic Point Dipole

Add an **Electrostatic Point Dipole** node to 3D and 2D components. Add a contribution as a **Harmonic Perturbation** by right-clicking the parent node or click **Harmonic Perturbation** on the **Physics** toolbar. For more information see [Harmonic Perturbation — Exclusive and Contributing Nodes](#) in the *COMSOL Multiphysics Reference Manual*.

The **Electrostatic Point Dipole** represents the limiting case of zero separation distance between two equally strong point sources of opposing signs while maintaining the product between separation distance and source strength at a fixed value (p). The dipole moment is a vector entity with positive direction from the negative charge to the positive one.

ELECTROSTATIC POINT DIPOLE

Select a **Dipole specification** — **Magnitude and direction** (the default) or **Electric dipole moment**.

- For **Magnitude and direction** enter coordinates for the **Electric dipole moment direction** \mathbf{n}_p (dimensionless) and the **Electric dipole moment, magnitude** p .
- For **Electric dipole moment** enter coordinates for the **Electric dipole moment** \mathbf{p} .

Archie's Law

This subfeature is available only when **Archie's law** is selected as the **Electrical conductivity** material parameter in the parent feature (for example, the **Current Conservation** node). Then the subnodes are made available from the context menu (right-click the parent node) as well as from the **Physics** toolbar, **Attributes** menu.

Use the **Archie's Law** subnode to provide an electrical conductivity computed using Archie's Law. This subnode can be used to model nonconductive effective medium saturated (or variably saturated) by conductive liquids, using the relation:

$$\sigma = s_L^n \varepsilon_p^m \sigma_L$$



Archie's Law Theory

CONDUCTION CURRENTS

By default, the **Electrical conductivity** σ_L (SI unit: S/m) for the fluid is defined **From material**. This uses the value of the conductivity of the material domain.

For **User defined** enter a value or expression. If another type of temperature dependence is used other than a linear temperature relation, enter any expression for the conductivity as a function of temperature.

Enter these dimensionless parameters as needed:

- **Cementation exponent** m
- **Saturation exponent** n
- **Fluid saturation** S_L
- **Porosity** ε_p to set up the volume fraction of the fluid.

Effective Medium

This subfeature is available only when **Effective medium** is selected as the material parameter (for example, **Relative permeability** or **Relative permittivity**) in the parent feature node when it is available with the physics interface (for example, the **Charge**

Conservation, **Current Conservation**, or **Ampere's Law** nodes). Then the subnodes are made available from the context menu (right-click the parent node) as well as from the **Physics** toolbar, **Attributes** menu.

Use the **Effective Medium** subfeature to specify the material properties of a domain consisting of a porous medium using a mixture model. Depending on the specific physics interface being used, the subfeature can be used to provide a mixture model for the electric conductivity σ , the relative dielectric permittivity ϵ_r , or the relative magnetic permeability μ_r .

EFFECTIVE MEDIUM

This section is always available and is used to define the mixture model for the domain.

Select the **Number of materials** (up to 5) to be included in the mixture model.

For each material (**Material 1**, **Material 2**, and so on), select either **Domain material**, to use the material specified for the domain, or one of the other materials specified in the **Materials** node. For each material, enter a **Volume fraction** θ_1 , θ_2 , and so on.

The Volume fractions specified for the materials should be fractional (between 0 and 1) and should add to 1 in normal cases.



The availability of the **Effective Electrical Conductivity**, **Effective Relative Permittivity**, and **Effective Relative Permeability** sections depend on the material properties used in the physics interface. In addition, these sections are only active if **Effective medium** is selected in the corresponding material property for the parent feature node.

EFFECTIVE ELECTRICAL CONDUCTIVITY, EFFECTIVE RELATIVE PERMITTIVITY, OR EFFECTIVE RELATIVE PERMEABILITY

Select the averaging method to use in the mixture model between the **Volume average** of the material property (for example, **conductivity** or **permittivity**), the volume average of its inverse (for example, the **resistivity**), or the **Power law**. For each material, specify either **From material**, to take the value from the corresponding material specified in the **Effective Medium** section, or **User defined** to manually input a value.



[Effective Material Properties in Effective Media and Mixtures](#)

The Electrostatics, Boundary Elements Interface

The **Electrostatics, Boundary Elements (esbe)** interface () found under the **AC/DC>Electric Fields and Currents** branch when adding a physics interface, is used for computing the potential distribution in dielectrics under conditions where the electric potential distribution on the boundaries is explicitly prescribed. The formulation is based on the boundary element method and the interface is available in 2D and 3D.

The physics interface solves Laplace's equation for the electric potential using the scalar electric potential as the dependent variable

$$-\nabla \cdot (\epsilon_0 \epsilon_r \nabla V) = 0.$$



For a discussion about the boundary element method, see [Theory for the Boundary Elements PDE](#) in the *COMSOL Multiphysics Reference Manual*.

When this physics interface is added, these default nodes are also added to the **Model Builder** — **Charge Conservation, Zero Charge** (on exterior boundaries and in 3D also on interior edges) and **Initial Values**. Then, from the **Physics** toolbar, add other nodes that implement, for example, electric potential and surface charge density conditions. You can also right-click **Electrostatics, Boundary Elements** to select physics features from the context menu.



If both [The Electrostatics Interface](#) and [The Electrostatics, Boundary Elements Interface](#) are available, the [Electric Scalar-Scalar Potential Coupling](#) node is available from the **Multiphysics** menu in the **Physics** toolbar or by right-clicking the **Multiphysics Couplings** node in **Model Builder**.



[The Electrostatics Interface](#) and [The Electrostatics, Boundary Elements Interface](#) can also be coupled by using the same name for the dependent variable for both interfaces. Then [Electric Scalar-Scalar Potential Coupling](#) is not needed. How to set the name for the dependent variable is described in the [Dependent Variables](#) section.

Physics-Controlled Mesh

The physics-controlled mesh is controlled from the **Mesh** node's **Settings** window (if the **Sequence type** is **Physics-controlled mesh**). There, in the table in the **Physics-Controlled Mesh** section, find the physics interface in the **Contributor** column and select or clear the check box in the **Use** column on the same table row for enabling (the default) or disabling contributions from the physics interface to the physics-controlled mesh.

Information from the physics will be used to automatically set up an appropriate mesh sequence.



In the *COMSOL Multiphysics Reference Manual* see the [Physics-Controlled Mesh](#) section for more information about how to define the physics-controlled mesh.

DOMAIN SELECTION

From the **Selection** list, select any of the options — **Manual**, **All domains**, **All voids**, or **All domains and voids** (the default). The geometric entity list displays the selected domain entity numbers. Edit the list of selected domain entity numbers using the selection toolbar buttons to the right of the list or by selecting the geometric entities in the **Graphics** window. Entity numbers for voids can be entered by clicking the Paste () button in the selection toolbar and supplying the entity numbers in the in the dialog box. The entity number for the infinite void is 0, and finite voids have negative entity numbers.

Selections can also be entered using the **Selection List** window, available from the **Windows** menu on the **Home** toolbar.



For more information about making selections, see [Working with Geometric Entities](#) in the *COMSOL Multiphysics Reference Manual*.

PHYSICS SYMBOLS

Select the **Enable physics symbols** check box to display symmetry planes (in 3D) and lines (in 2D) in the **Graphics** window, as specified in the [Symmetry](#) settings.

THICKNESS (2D COMPONENTS)

For 2D components, enter a default value for the **Out-of-plane thickness** d (SI unit: m). The default value of 1 is typically not representative for a thin dielectric medium.

Instead it describes a unit thickness that makes the 2D equation identical to the equation used for 3D components.

MANUAL TERMINAL SWEEP SETTINGS

Select the **Activate manual terminal sweep** check box to invoke a parametric sweep over terminals. Enter a **Sweep parameter name** to assign a specific name to the variable that controls the terminal number solved for during the sweep. The **Sweep parameter name** must also be declared as a model parameter. The default is PortName.



For most applications it is simpler to sweep over terminals using the Stationary Source Sweep study step. See [Stationary Source Sweep](#) in the *COMSOL Multiphysics Reference Manual* and (for more details) [Stationary Source Sweep](#) in the [Modeling with the AC/DC Module](#) chapter of this manual.



To correctly calculate the terminal charge and the corresponding capacitances, if voltage [Terminal](#) is used on boundaries between [The Electrostatics Interface](#) and [The Electrostatics, Boundary Elements Interface](#), let the dependent variable for [The Electrostatics, Boundary Elements Interface](#) be the same as the dependent variable for [The Electrostatics Interface](#) and disable [Electric Scalar-Scalar Potential Coupling](#). How to set the name for the dependent variable is described in the [Dependent Variables](#) section. Since the [Electric Scalar-Scalar Potential Coupling](#) is disabled, add manually a Fully Coupled node to the Stationary Solver below the Solution node in the Solver Configurations.

SYMMETRY



For 3D components, from the **Symmetry in the yz plane**, **Symmetry in the xz plane**, **Symmetry in the xy plane** lists, choose **Off** (the default), **Symmetric**, or **Antisymmetric**. Then enter a **Plane position** (SI unit: m) as required.



For 2D components, from the **Symmetry in the line perpendicular to x** and **Symmetry in the line perpendicular to y** lists, choose **Off** (the default), **Symmetric**, or **Antisymmetric**. Then enter a **Line position** (SI unit: m) as required.

FAR-FIELD APPROXIMATION

To display this section, click the **Show More Options** button () and select **Advanced Physics Options** in the **Show More Options** dialog box.



For more information about the **Far Field Approximation** settings, see [Far-Field Approximation Settings](#) in the *COMSOL Multiphysics Reference Manual*.

INFINITY CONDITION



For 3D components, select the **Infinity condition — Total charge** (the default) or **Asymptotic value at infinity**. Specify the **Total charge** Q_{tot} (SI unit: C; the default value is 0 C) or **Electric potential at infinity** V_{∞} (SI unit: V; the default value is 0 V). If there is an antisymmetric symmetry in the potential field, it acts as an added infinite ground plane with a fixed value of the electric potential. The value at infinity is fixed to 0 by the presence of the infinite ground plane, so for this case there is a fixed **Zero potential at infinity** condition.



For 2D components, select the **Infinity condition — Total charge** (the default) or **Value at reference distance**. Specify the **Total charge** Q_{tot} (SI unit: C; the default value is 0 C) or **Electric potential at reference distance** V_{ref} (SI unit: V; the default value is 0 V). If there is an antisymmetric symmetry in the potential field, it acts as an added ground line with a fixed value of the electric potential. The value at a reference distance is fixed to 0 by the presence of the ground line, so for this case there is a fixed **Zero potential at reference distance** condition.

QUADRATURE

To display this section, click the **Show More Options** button () and select **Advanced Physics Options** in the **Show More Options** dialog box.



For more information about the **Quadrature** settings, see [Quadrature](#) in the *COMSOL Multiphysics Reference Manual*.

DISCRETIZATION

From the **Electric potential/Surface charge density** list, choose from predefined options for the boundary element discretization order for the electric potential variable and the surface charge density variable, respectively. The predefined options represent the suitable combinations of element orders such as **Quadratic/Linear** (the default).



For 3D components, the Line charge variable will have the same discretization order as the Electric potential variable.

The settings under **Value types when using splitting of complex variables** are important for sensitivity and optimization computations. See the description of the built-in operators `fsens` and `fsensimag`.

DEPENDENT VARIABLES

The dependent variable (field variable) is for the **Electric potential** V . The name can be changed but the names of fields and dependent variables must be unique within a model.

Domain, Boundary, and Edge Nodes for the Electrostatics, Boundary Elements Interface

The [Electrostatics, Boundary Elements Interface](#) has these domain, boundary, and edge nodes available from the **Physics** ribbon (Windows users), **Physics** context menu (Mac or Linux users), or by right-clicking the physics interface in **Model Builder** to access the context menu (all users).



In general, to add a node, go to the **Physics** toolbar, no matter what operating system you are using. Subnodes are available by clicking the parent node and selecting it from the **Attributes** menu.

AVAILABLE NODES

These nodes and subnodes are described in this section:

- [Initial Values](#)
- [Charge Conservation](#)
- [Electric Potential](#)
- [Floating Potential](#)
- [Force Calculation](#)
- [Ground](#)
- [Surface Charge Density](#)
- [Terminal](#)
- [Zero Charge](#)

The [Zero Charge](#) node is the default boundary and edge condition available for this physics interface and described for the Electrostatics interface.

Initial Values

Initial Values adds an initial value for the electric potential that can serve as an initial condition for a transient simulation or as an initial guess for a nonlinear solver. Add more **Initial Values** nodes from the **Physics** toolbar, **Global** menu.

INITIAL VALUES

Enter a value or expression for the initial value of the **Electric potential** V (SI unit: V).

Charge Conservation

The **Charge Conservation** node adds the equations for charge conservation according to Gauss' law for the electric displacement field. It provides an interface for defining the constitutive relation defined by the relative permittivity.

CONSTITUTIVE RELATION D-E

Enter the **Relative permittivity** ϵ_r (dimensionless) to describe the macroscopic properties of the medium. The default is to take the **Relative permittivity** values **From material**. For **User defined**, enter a value or expression in the field.



Notice that the boundary element method is based on the availability of an analytic Green's function for the domain. Thus, the **Relative permittivity** must evaluate to a constant value for each **Charge Conservation** node.

Electric Potential

The **Electric Potential** node provides an electric potential V_0 as the boundary condition $V = V_0$.



For more information about the Electric Potential condition, see [Electric Potential](#) in the documentation for the Electrostatics interface.



For 3D components, enter the **Edge radius** (SI unit: m) for the virtual tube surrounding the edge. The default value is 0.1 m. It is generally assumed that the edge radius is small in comparison to other geometrical measures of the model, such as the edge length and the distances between different edges in the geometry.

Floating Potential

The **Floating Potential** node is used when modeling a metallic electrode at floating potential.



For more information about the Floating Potential condition, see [Floating Potential](#) in the documentation for the Electrostatics interface.



For 3D components, enter the **Edge radius** (SI unit: m) for the virtual tube surrounding the edge. The default value is 0.1 m. It is generally assumed that the edge radius is small in comparison to other geometrical measures of the model, such as the edge length and the distances between different edges in the geometry.

Ground

The **Ground** node implements ground (zero potential) as the boundary condition $V = 0$.



For more information about the Ground condition, see [Ground](#) in the documentation for the Electrostatics interface.



For 3D components, enter the **Edge radius** (SI unit: m) for the virtual tube surrounding the edge. The default value is 0.1 m. It is generally assumed that the edge radius is small in comparison to other geometrical measures of the model, such as the edge length and the distances between different edges in the geometry.

Surface Charge Density

The **Surface Charge Density** node provides the following surface-charge boundary condition for exterior boundaries (left) and interior boundaries (right):

$$-\mathbf{n} \cdot \mathbf{D} = \rho_s, \quad \mathbf{n} \cdot (\mathbf{D}_1 - \mathbf{D}_2) = \rho_s$$

Specify the surface charge density ρ_s at an outer boundary or at an interior boundary between two nonconducting media.



For more information about the Surface Charge Density condition, see [Surface Charge Density](#) in the documentation for the Electrostatics interface.



For 3D components, enter the **Edge radius** (SI unit: m) for the virtual tube surrounding the edge. The default value is 0.1 m. It is generally assumed that the edge radius is small in comparison to other geometrical measures of the model, such as the edge length and the distances between different edges in the geometry. Enable **Compensate for tube volume** to allow for a potential gradient across the cross section of the virtual tube. This can be useful for establishing a zero surface charge density condition on the virtual tube periphery.

Terminal

The **Terminal** node provides a boundary or domain condition for connection to external circuits, to transmission lines, or with a specified voltage or charge.



For more information about the Terminal condition, see [Terminal](#) in the documentation for the Electrostatics interface.



For 3D components, enter the **Edge radius** (SI unit: m) for the virtual tube surrounding the edge. The default value is 0.1 m. It is generally assumed that the edge radius is small in comparison to other geometrical measures of the model, such as the edge length and the distances between different edges in the geometry.



To correctly calculate the terminal charge and the corresponding capacitances, if voltage [Terminal](#) is used on boundaries between [The Electrostatics Interface](#) and [The Electrostatics, Boundary Elements Interface](#), let the dependent variable for [The Electrostatics, Boundary Elements Interface](#) be the same as the dependent variable for [The Electrostatics Interface](#) and disable [Electric Scalar-Scalar Potential Coupling](#). How to set the name for the dependent variable is described in the [Dependent Variables](#) section. Since the [Electric Scalar-Scalar Potential Coupling](#) is disabled, add manually a Fully Coupled node to the Stationary Solver below the Solution node in the Solver Configurations.

Zero Charge

The **Zero Charge** node adds the condition that there is zero charge on the boundary so that $\mathbf{n} \cdot \mathbf{D} = 0$. This is the default boundary condition on exterior boundaries and on edges embedded within a [Charge Conservation](#) feature.

Electric Scalar-Scalar Potential Coupling

The **Electric Scalar-Scalar Potential Coupling** multiphysics node assures continuity of the electric potential across boundaries between [The Electrostatics Interface](#) and [The Electrostatics, Boundary Elements Interface](#). The **Electric Scalar-Scalar Potential Coupling** node is available from the **Multiphysics** menu in the **Physics** toolbar or by right-clicking the **Multiphysics Couplings** node in **Model Builder**, if both [The](#)

[Electrostatics Interface](#) and [The Electrostatics, Boundary Elements Interface](#) are available.



[The Electrostatics Interface](#) and [The Electrostatics, Boundary Elements Interface](#) can also be coupled by using the same name for the dependent variable for both interfaces. Then **Electric Scalar-Scalar Potential Coupling** is not needed. How to set the name for the dependent variable is described in the [Dependent Variables](#) section.



When using [The Electrostatics, Boundary Elements Interface](#) with iterative solvers, **Right Preconditioning** is preferred. Thus, it is advised to check that **Right Preconditioning** is used when combining the **Electric Scalar-Scalar Potential Coupling** with [The Electrostatics, Boundary Elements Interface](#) and other physics interfaces. How to define **Right Preconditioning** is described in [Iterative](#) in the *COMSOL Multiphysics Reference Manual*.

BOUNDARY SELECTION

Select **Manual** or **All boundaries** from the **Selection** list. Make additional edits to the list of boundary entity numbers using the Selection toolbar buttons. When **All boundaries** is selected from the **Selection** list, the boundaries exterior to the Electrostatics interface that intersect the exterior boundaries to the Electrostatics, Boundary Elements interface are available in the boundary entity number list.

COUPLED INTERFACES

- Select **Electrostatics, Boundary Elements** as **Primary interface** and **Electrostatics** and **Secondary interface**.

The Electric Currents Interface

The **Electric Currents (ec)** interface () , under the **AC/DC>Electric Fields and Currents** branch when adding a physics interface, is used to compute electric field, current, and potential distributions in conducting media under conditions where inductive effects are negligible; that is, when the skin depth is much larger than the studied device.

Depending on the licensed products, stationary, frequency-domain, small-signal analysis, and time-domain modeling are supported in all space dimensions. In the time and frequency domains, capacitive effects are also accounted for.

The physics interface solves a current conservation equation based on Ohm's law using the scalar electric potential as the dependent variable.

Current Conservation is the main node, which adds the equation for the electric potential and provides a Settings window for defining the electrical conductivity as well as the constitutive relation for the electric displacement field and its associated material properties, such as the relative permittivity.

When this physics interface is added, these default nodes are also added to the **Model Builder** — **Current Conservation**, **Electric Insulation** (the default boundary condition), and **Initial Values**. Then, from the **Physics** toolbar, add other nodes that implement, for example, boundary conditions and current sources. You can also right-click **Electric Currents** to select physics features from the context menu.

Physics-Controlled Mesh

The physics-controlled mesh is controlled from the **Mesh** node's **Settings** window (if the **Sequence type** is **Physics-controlled mesh**). There, in the table in the **Physics-Controlled Mesh** section, find the physics interface in the **Contributor** column and select or clear the check box in the **Use** column on the same table row for enabling (the default) or disabling contributions from the physics interface to the physics-controlled mesh.

Information from the physics, such as the presence of an infinite elements domain or periodic condition, will be used to automatically set up an appropriate mesh sequence.



In the *COMSOL Multiphysics Reference Manual* see the [Physics-Controlled Mesh](#) section for more information about how to define the physics-controlled mesh.

SETTINGS

The **Label** is the default physics interface name.

The **Name** is used primarily as a scope prefix for variables defined by the physics interface. Refer to such physics interface variables in expressions using the pattern `<name>.<variable_name>`. In order to distinguish between variables belonging to different physics interfaces, the `name` string must be unique. Only letters, numbers, and underscores (`_`) are permitted in the **Name** field. The first character must be a letter.

The default **Name** (for the first physics interface in the model) is `ec`.

CROSS-SECTION AREA (1D)

Enter a default value for the **Cross-section area** A (SI unit: m^2). The default value of 1 is typically not representative for a thin domain. Instead it describes a unit thickness that makes the 1D equation identical to the equation used for 3D components. See also [Change Cross Section](#) (described for the Electrostatics interface).

THICKNESS (2D)

Enter a default value for the **Out-of-plane thickness** d (SI unit: m) (see [Equation 4-1](#)). The default value of 1 m is typically not representative for a thin dielectric medium, for example. Instead it describes a unit thickness that makes the 2D equation identical to the equation used for 3D components. See also [Change Thickness \(Out-of-Plane\)](#) (described for the Electrostatics interface).

MANUAL TERMINAL SWEEP SETTINGS

Enter a **Reference impedance** Z_{ref} (SI unit: Ω). The default is 50 Ω .

Select the **Activate manual terminal sweep** check box to switch on the sweep and invoke a parametric sweep over the terminals. Enter a **Sweep parameter name** to assign a specific name to the variable that controls the terminal number solved for during the sweep. The default is `PortName`. The generated lumped parameters are in the form of capacitance matrix elements. The terminal settings must consistently be of either fixed voltage or fixed charge type.

The lumped parameters are subject to **Touchstone file export**. Enter a file path or **Browse** for a file. Select a **Parameter format (value pairs)** for the Touchstone export — **Magnitude and angle (MA)** (the default), **Magnitude in dB and angle (DB)**, or **Real and imaginary parts (RI)**. Select an option from the **If file exists** list — **Overwrite** or **Create**

new. Create new is useful when the model is solved multiple times with different settings. Select a **Parameter to export** — **Z** (the default), **Y**, or **S**.



For most applications it is simpler to sweep over terminals using the Stationary Source Sweep study step. See [Stationary Source Sweep](#) in the *COMSOL Multiphysics Reference Manual* and (for more details) [Stationary Source Sweep](#) in the *AC/DC Module User's Guide*.

DEPENDENT VARIABLES

The dependent variable is the **Electric potential** V . You can change its name, which changes both the field name and the variable name. If the new name coincides with the name of another electric potential field in the model, the physics interfaces share degrees of freedom. The new name must not coincide with the name of a field of another type or with a component name belonging to some other field.

DISCRETIZATION



- [Lumped Parameters](#)
- [Domain, Boundary, Edge, Point, and Pair Nodes for the Electric Currents Interface](#)
- [Theory for the Electric Currents Interface](#)



Pacemaker Electrode: Application Library path
COMSOL_Multiphysics/Electromagnetics/pacemaker_electrode

Domain, Boundary, Edge, Point, and Pair Nodes for the Electric Currents Interface

The Electric Currents interface has these domain, boundary, edge, point, and pair nodes available from the **Physics** ribbon toolbar (Windows users) or **Physics** context

menu (Mac or Linux users). You can also right-click to access the context menu (all users).



In general, to add a node, go to the **Physics** toolbar, no matter what operating system you are using. Subnodes are available by clicking the parent node and selecting it from the **Attributes** menu.

ABOUT THE BOUNDARY CONDITIONS

The exterior and interior boundary conditions listed in [Table 4-1](#) are available. The relevant physics interface condition at interfaces between different media and interior boundaries is continuity; that is,

$$\mathbf{n}_2 \cdot (\mathbf{J}_1 - \mathbf{J}_2) = 0$$

which is the natural boundary condition.

AVAILABLE NODES

These nodes are available for this physics interface, listed in alphabetical order. Also see [Table 4-1](#) for a list of interior and exterior boundary conditions, including edge, point, and pair availability.

- [Boundary Current Source](#)
- [Contact Impedance](#)
- [Current Conservation](#)
- [Current Source](#)
- [Distributed Impedance](#)
- [Electric Insulation](#)
- [Electric Point Dipole](#)
- [Electric Point Dipole \(on Axis\)](#)
- [Electric Shielding](#)
- [Electrical Contact](#)
- [External Current Density](#)
- [Floating Potential](#)
- [Initial Values](#)
- [Line Current Source](#)
- [Line Current Source \(on Axis\)](#)
- [Normal Current Density](#)
- [Piezoresistive Material¹](#)
- [Point Current Source](#)
- [Sector Symmetry](#)
- [Terminal](#)

¹This feature is available with the Piezoresistivity, Domain Currents interface, which requires the MEMS Module.

These nodes are described for the Electrostatics interface:

- [Archie's Law](#)
- [Change Cross Section](#)
- [Change Thickness \(Out-of-Plane\)](#)
- [Effective Medium](#)
- [Electric Potential](#)
- [Force Calculation](#)
- [Ground](#)
- [Periodic Condition](#)



In the *COMSOL Multiphysics Reference Manual*, see [Table 2-4](#) for links to common sections and [Table 2-5](#) for common feature nodes. You can also search for information: press F1 to open the **Help** window or Ctrl+F1 to open the **Documentation** window.



For axisymmetric components, COMSOL Multiphysics takes the axial symmetry boundaries (at $r = 0$) into account and automatically adds an **Axial Symmetry** node to the model that is valid on the axial symmetry boundaries only.

[Table 4-1](#) lists the interior and exterior boundary conditions available with this physics interface. It also includes edge, point, and pair availability.

TABLE 4-2: INTERIOR AND EXTERIOR BOUNDARY CONDITIONS (INCLUDING EDGE, POINT, AND PAIR AVAILABILITY) FOR THE ELECTRIC CURRENTS INTERFACE

NODE	INTERIOR	EXTERIOR	ALSO AVAILABLE FOR
Boundary Current Source	x		pairs
Contact Impedance	x		pairs
Distributed Impedance	x	x	not applicable
Electric Insulation	x	x	pairs
Electric Potential	x	x	edges, points, and pairs
Electric Shielding	x	x	pairs
Floating Potential	x	x	pairs
Ground	x	x	edges, points, and pairs
Normal Current Density		x	not applicable

TABLE 4-2: INTERIOR AND EXTERIOR BOUNDARY CONDITIONS (INCLUDING EDGE, POINT, AND PAIR AVAILABILITY) FOR THE ELECTRIC CURRENTS INTERFACE

NODE	INTERIOR	EXTERIOR	ALSO AVAILABLE FOR
Periodic Condition		x	not applicable
Terminal	x	x	pairs, domains

Current Conservation

The **Current Conservation** node adds the continuity equation for the electrical potential and provides an interface for defining the electric conductivity as well as the constitutive relation and the relative permittivity for the displacement current.

MATERIAL TYPE

The **Material type** setting decides how materials behave and how material properties are interpreted when the mesh is deformed. Select **Solid** for materials whose properties change as functions of material strain, material orientation, and other variables evaluated in a material reference configuration (material frame). Select **Non-solid** for materials whose properties are defined only as functions of the current local state at each point in the spatial frame, and for which no unique material reference configuration can be defined. Select **From material** to pick up the corresponding setting from the domain material on each domain.

CONSTITUTIVE RELATION JC-E

By default, the **Electrical conductivity** σ (SI unit: S/m) for the media is defined **From material**. Or select **User defined**, **Effective medium**, **Archie's Law**, or **Linearized resistivity**.

User Defined

For **User defined** select **Isotropic**, **Diagonal**, **Symmetric**, or **Full** depending on the characteristics of the electrical conductivity, and then enter values or expressions for the electrical conductivity σ in the field or matrix. The default is 0 S/m. If type of temperature dependence is used other than a linear temperature relation, enter any expression for the conductivity as a function of temperature.

Linearized Resistivity

Select **Linearized resistivity** for a temperature-dependent conductivity (this occurs in, for example, Joule heating, and is also called resistive heating). The equation describing the conductivity:

$$\sigma = \frac{1}{\rho_0(1 + \alpha(T - T_{\text{ref}}))}$$

where ρ_0 is the resistivity at the reference temperature T_{ref} , and α is the temperature coefficient of resistance, which describes how the resistivity varies with temperature.

The default **Reference resistivity** ρ_0 (SI unit: $\Omega\cdot\text{m}$), **Reference temperature** T_{ref} (SI unit: K), and **Resistivity temperature coefficient** α (SI unit: 1/K) are taken **From material**, which means that the values are taken from the domain (or boundary) material. T is the current temperature, which can be a value that is specified as a model input or the temperature from a heat transfer interface. The definition of the temperature field is in the **Model Inputs** section.



Only certain material models support the **Linearized resistivity**. See [AC/DC Materials Database](#) in the *COMSOL Multiphysics Reference Manual*.

To specify other values for any of these properties, select **User defined** from the list and then enter a value or expression for each. The default values are:

- 1 $\Omega\cdot\text{m}$ for the Reference resistivity
- 273.15 K for the Reference temperature, and
- 0 1/K for the Resistivity temperature coefficient

When **Effective medium** is selected, either right-click Current Conservation or on the **Physics** toolbar, **Attributes** menu click to add a [Effective Medium](#) subnode. When **Archie's law** is selected, do the same to add an [Archie's Law](#) subnode.

CONSTITUTIVE RELATION D-E

Select a **Dielectric model** to describe the macroscopic properties of the medium (relating the electric displacement \mathbf{D} with the electric field \mathbf{E}) and the applicable material properties, such as the relative permittivity. For a description of the constitutive relations **Relative permittivity**, **Polarization**, and **Remanent electric displacement**, see **Electric Field** as described for the [Charge Conservation](#) node for the Electrostatics interface. The constitutive relations specific to Electric Currents are:

- **Dielectric losses**: uses the constitutive relation $\mathbf{D} = \epsilon_0(\epsilon' + \epsilon''\mathbf{j})\mathbf{E}$. Specify that the **Relative permittivity (real part)** ϵ' (dimensionless) and the **Relative permittivity (imaginary part)** ϵ'' (dimensionless) must be taken **From material** or be **User defined**. For **User defined**, select **Isotropic**, **Diagonal**, **Symmetric**, or **Full** and enter values or expressions in the field or matrix. The default is 1.

- **Loss tangent, loss angle:** uses the constitutive relation $\mathbf{D} = \epsilon_0 \epsilon' (1 + j \tan \delta) \mathbf{E}$. Specify the **Relative permittivity (real part)** ϵ' (dimensionless) and **Loss angle** δ (SI unit: rad).
- **Loss tangent, dissipation factor:** uses the constitutive relation $\mathbf{D} = \epsilon_0 \epsilon' (1 + j \tan \delta) \mathbf{E}$. Specify the **Relative permittivity (real part)** ϵ' (dimensionless) and the **Dissipation factor** $\tan \delta$ (dimensionless).

Initial Values

The **Initial Values** node adds an initial value for the electric potential that can serve as an initial condition for a transient simulation or as an initial guess for a nonlinear solver. If more than one set of initial values is required, from the **Physics** toolbar, add other nodes that implement, for example, boundary conditions and current sources. Add more **Initial Values** nodes from the **Physics** toolbar.

INITIAL VALUES

Enter a value or expression for the initial value of the **Electric potential** V (SI unit: V). The default value is 0 V.

External Current Density

The **External Current Density** node adds an externally generated current density \mathbf{J}_e , which appears in Ohm's law

$$\mathbf{J} = \sigma \mathbf{E} + \mathbf{J}_e$$

and in the equation that the physics interface defines.

The external current density does not contribute to the losses (due to Joule heating), since there is no electric field associated with it. To include the contribution to the losses from the external current density, select the **Add contribution of the external current density to the losses** check box. Then select an option from the **External losses** list — **From domain conductivity** (the default) or **User defined**. If **From domain conductivity** is selected, the heat source is computed using the conductivity specified in the material model feature (such as **Current Conservation**) that is applied in the domain. For **User defined**, enter a value for Q_e (SI unit: W/m^3) to specify a user-defined heat source.

Add a contribution as a **Harmonic Perturbation** by right-clicking the parent node or clicking **Harmonic Perturbation** on the **Physics** toolbar. For more information see

[Harmonic Perturbation — Exclusive and Contributing Nodes](#) in the *COMSOL Multiphysics Reference Manual*.

EXTERNAL CURRENT DENSITY

Based on space dimension, enter the coordinates (\mathbf{x} , \mathbf{y} , and \mathbf{z} for 3D components, for example) of the **External current density** \mathbf{J}_e (SI unit: A/m²). The defaults are 0 A/m².

Current Source

The **Current Source** node adds a distributed current source Q_j in the equation that the physics interface defines. Use this node with caution as it can violate the current conservation law that is inherent in Maxwell-Ampère's law.

Add a contribution as a **Harmonic Perturbation** by right-clicking the parent node or clicking **Harmonic Perturbation** on the **Physics** toolbar. For more information see [Harmonic Perturbation — Exclusive and Contributing Nodes](#) in the *COMSOL Multiphysics Reference Manual*.

CURRENT SOURCE

Enter a value or expression for the **Current source** Q_j (SI unit: A/m³). The default is 0 A/m³.

Electric Insulation

The **Electric Insulation** node, which is the default boundary condition, adds electric insulation as the boundary condition:

$$\mathbf{n} \cdot \mathbf{J} = 0$$

This boundary condition means that no electric current flows into the boundary. At interior boundaries, it means that no current can flow through the boundary and that the electric potential is discontinuous across the boundary. It is also applicable at symmetric boundaries where the potential is known to be symmetric with respect to the boundary.

Electric insulation as the default boundary condition is not applicable to interior boundaries. To add electric insulation to an interior boundary, add an **Electric Insulation** node in addition to the one that represents the default boundary condition.

Floating Potential

The **Floating Potential** node is used when modeling a metallic electrode at floating potential. It applies a constant voltage V_0 on the boundary (for domain features, this is the boundary enclosing the selected domain), such that the total normal electric current density \mathbf{J} equals a specific current I_0 :

$$V = V_0$$
$$\int_{\partial\Omega} (-\mathbf{n} \cdot \mathbf{J}) dS = I_0,$$

where Ω represents the boundary and \mathbf{n} refers to the surface normal. The constant boundary voltage implies the tangential electric field equals zero; the electric field will be perpendicular to the boundary:

$$-\nabla_t V = \mathbf{E}_t = 0$$
$$\mathbf{n} \times \mathbf{E} = 0.$$

In case of $I_0 = 0$ (the default case), the boundary will behave as an unconnected perfect conductor (a floating equipotential). This is a good approximation when the conductivity of the electrode is many orders of magnitude larger than that of the surrounding medium. Although locally the current density may vary, the total current entering or leaving the boundary equals zero.

If the floating potential touches a point, boundary or domain feature that is not floating (a **Terminal** or **Ground** feature), the floating potential will acquire that feature's potential. If the floating potential is set to a certain current, or connected to a circuit, it behaves like a terminal.

The **Harmonic Perturbation** subnode (it is of the exclusive type) is available from the context menu (right-click the parent node) or on the **Physics** toolbar, click the **Attributes** menu and select **Harmonic Perturbation**. For more information see [Harmonic Perturbation — Exclusive and Contributing Nodes](#) in the *COMSOL Multiphysics Reference Manual*.

FLOATING POTENTIAL

The Floating potential identifier text area shows the unique identifier for the floating potential feature. It is used to identify the global variables created by the node, such as the voltage. The **Floating potential group** check box on the **Settings** window for **Floating Potential** controls how potentials are assigned to boundary segments in the feature's boundary selection. If this check box is not selected, a single potential is applied to all

boundaries in the selection. If the check box is selected, each group of contiguous boundaries in the selection is given a unique potential. This simplifies the setup of models with many floating electrodes. The values of the potential at each group of boundaries are then made available in postprocessing, collected in a vector variable.

The following options are not available if the **Floating potential group** check box is selected. Select a specification for the **Floating potential current** — choose **User defined** (the default) to specify a total **Current** I_0 (SI unit: A) that flows from the electrode. The default is 0 A, corresponding to an unconnected electrode. Select **Circuit** to connect the floating potential to an Electrical Circuit interface.

Initial values

The initial values subsection is used to provide initial values for the internal state variables in the Floating Potential. These settings can be useful to provide an initial guess to the nonlinear solver or the initial value in a time-dependent study when the initial values of the other dependent variables (such as the electric potential) are computed from a separate physics or study. In most cases, the default values are appropriate.

Enter an **Initial value for voltage** V_{init} (SI unit: V). The default is 0 V.

CONSTRAINT SETTINGS

To display this section, click the **Show More Options** button () and select **Advanced Physics Options** in the **Show More Options** dialog box.



Settings and Properties Windows for Feature Nodes in the *COMSOL Multiphysics Reference Manual*

Boundary Current Source

The **Boundary Current Source** node adds a current source Q_j on the boundary.

$$\mathbf{n} \cdot (\mathbf{J}_1 - \mathbf{J}_2) = Q_j$$

It is applicable to interior boundaries that represent either a source or a sink of current. Add a contribution as a **Harmonic Perturbation** by right-clicking the parent node or click **Harmonic Perturbation** on the **Physics** toolbar. For more information see [Harmonic Perturbation — Exclusive and Contributing Nodes](#) in the *COMSOL Multiphysics Reference Manual*.

BOUNDARY CURRENT SOURCE

Enter a value or expression for the **Boundary current source** Q_j (SI unit: A/m^2). The default is $0 A/m^2$.

Normal Current Density

The **Normal Current Density** node is applicable to exterior boundaries that represent either a source or a sink of current. It provides a condition for specifying the normal current density as an inward or outward current flow:

$$-\mathbf{n} \cdot \mathbf{J} = J_n$$

Or alternatively, as a current density \mathbf{J}_0 :

$$\mathbf{n} \cdot \mathbf{J} = \mathbf{n} \cdot \mathbf{J}_0$$

The normal current density is positive when the current flows inward in the domain. Add a contribution as a **Harmonic Perturbation** by right-clicking the parent node or clicking **Harmonic Perturbation** on the **Physics** toolbar. For more information see [Harmonic Perturbation — Exclusive and Contributing Nodes](#) in the *COMSOL Multiphysics Reference Manual*.

NORMAL CURRENT DENSITY

Select a **Type** — **Inward current density** (the default) or **Current density**.

- For **Inward current density** enter a value or expression for the **Normal current density** J_n (SI unit: A/m^2). Use a positive value for an inward current flow or a negative value for an outward current flow. The default is $0 A/m^2$.
- For **Current density** enter values or expressions for the components of the **Current density** \mathbf{J}_0 (SI unit: A/m^2). The defaults are $0 A/m^2$.

Distributed Impedance

The **Distributed Impedance** node adds a distributed impedance boundary condition to a model.

The **Harmonic Perturbation** subnode (it is of the exclusive type) is available from the context menu (right-click the parent node) or on the **Physics** toolbar, click the **Attributes** menu and select **Harmonic Perturbation**. For more information see [Harmonic Perturbation — Exclusive and Contributing Nodes](#) in the *COMSOL Multiphysics Reference Manual*.

Use this boundary condition to model a thin sheet of a resistive material connected to a reference potential V_{ref} .

The layer impedance can be specified either with the bulk material conductivity σ_s , the relative permittivity ϵ_r and layer thickness d_s , or directly with the surface resistance ρ_s and capacitance C_s . Assuming DC currents, the equation is:

$$\mathbf{n} \cdot (\mathbf{J}_1 - \mathbf{J}_2) = \frac{\sigma_s}{d_s} (V - V_{\text{ref}})$$

$$\mathbf{n} \cdot (\mathbf{J}_1 - \mathbf{J}_2) = \frac{1}{\rho_s} (V - V_{\text{ref}})$$

For the Frequency Domain and Time Dependent study types, this boundary condition is slightly more sophisticated and accounts also for capacitive coupling. The equations are:

$$\mathbf{n} \cdot (\mathbf{J}_1 - \mathbf{J}_2) = \frac{(\sigma + j\omega\epsilon_0\epsilon_r)}{d_s} (V - V_{\text{ref}})$$

$$\mathbf{n} \cdot (\mathbf{J}_1 - \mathbf{J}_2) = \left(\frac{1}{\rho_s} + j\omega C_s \right) (V - V_{\text{ref}})$$

$$\mathbf{n} \cdot (\mathbf{J}_1 - \mathbf{J}_2) = \frac{1}{d_L} \left(\sigma (V - V_{\text{ref}}) + \epsilon_0 \epsilon_r \frac{\partial}{\partial t} (V - V_{\text{ref}}) \right)$$

$$\mathbf{n} \cdot (\mathbf{J}_1 - \mathbf{J}_2) = \left(\frac{1}{\rho_s} (V - V_{\text{ref}}) + C_s \frac{\partial}{\partial t} (V - V_{\text{ref}}) \right)$$

DISTRIBUTED IMPEDANCE

Enter the reference potential V_{ref} (SI unit: V). The default is 0 V.

Select a potentially complex-valued **Layer specification** — **Thin layer** (the default) or **Surface impedance**.

- For **Thin layer**, enter values or expressions for the:
 - **Surface thickness** d_s (SI unit: m). The default is $5 \cdot 10^{-3}$ m (5 mm).
 - **Electrical conductivity** σ (SI unit: S/m) and **Relative permittivity** ϵ_r (dimensionless). The defaults take values **From material**. For **User defined**, enter different values or expressions. The default electrical conductivity is $1 \cdot 10^{-2}$ S/m and the default relative permittivity is 1.
- For **Surface impedance**, enter values or expressions for the **Surface resistance** ρ_s (SI unit: $\Omega \cdot \text{m}^2$) and the **Surface capacitance** C_s (SI unit: F/m²). The default surface impedance is $1 \cdot 10^{-8}$ $\Omega \cdot \text{m}^2$ and the default surface capacitance is 0 F/m².

Terminal

The **Terminal** node provides a boundary or domain condition for connection to external circuits, to transmission lines, or with a specified voltage or current. By specifying zero current, a floating potential condition is obtained.



In most cases, it is not recommended to include the interior of good conductors in the simulation. When using the **Terminal** on the domain level, the interior unknowns for the electric potential are replaced by a single constant, thus avoiding numerical problems arising from a very high material contrast. If one instead uses the **Terminal** on the boundary level, it is recommended to exclude the interior of the associated conductor from the domain selection for the main Electric Currents node.

The **Terminal** node also enables the computation of the lumped parameter of the system, such as the impedance.

The **Harmonic Perturbation** subnode (it is of the exclusive type) is available from the context menu (right-click the parent node) or on the **Physics** toolbar, click the **Attributes** menu and select **Harmonic Perturbation**. The **Harmonic Perturbation** subnode only has effect if **Current** or **Voltage** are selected as terminal type. For more information see [Harmonic Perturbation — Exclusive and Contributing Nodes](#) in the *COMSOL Multiphysics Reference Manual*.

TERMINAL

Specify the terminal's properties. The **Terminal name** identifies the terminal and the variables it creates. The name should be numeric for sweeps to work properly.

Select a **Terminal type** — **Current** (the default), **Voltage**, **Circuit**, **Terminated**, or **Power**.



The **Circuit** and **Power** types cannot be used together with a terminal sweep.

Select:

- **Current** to specify a total current flowing from the terminal. Enter the current I_0 (SI unit: A). The default is 0 A for an open circuit.

- **Voltage** to specify a fixed electric potential at the terminal. Enter the value of the electric potential V_0 (SI unit: V). The default is 1 V.
- **Circuit** to specify a terminal connected to an Electrical Circuit interface that models an external circuit.
- **Terminated** to connect the terminal to an impedance that might represent a load or a transmission line. When **Terminated** is selected, the scattering parameters (S-parameters) are computed.
 - Enter a **Terminal power** P_0 (SI unit: W) to specify the input power at this terminal from the transmission line. This excitation can be toggled using a terminal sweep. The default is 1 W.
 - Select an option from the **Characteristic impedance from** list to define the value of the impedance — **Physics interface** (the default) or **User defined**. For **Physics interface** the **Reference impedance** Z_{ref} defined on the **Settings** window for the physics interface under Sweep Settings is used. For **User defined** enter a specific impedance Z_{ref} (SI unit: Ω) for this terminal. The default is 50 Ω .
- **Power** to specify a fixed electrical power for the terminal. The power is computed as the product of the terminal current and voltage and, in frequency domain, is the cycle-averaged power. When **Power** is selected:
 - Enter a **Terminal power** P_0 (SI unit: W) to specify the input power at this terminal. The default is 1 W.

Using Power excitation causes the equation system to become nonlinear. COMSOL Multiphysics automatically adjusts the solver settings when Power is selected.



Be aware that, in general, the values of the voltage and the current might not uniquely be determined by this constraint and may depend on the initial value provided for the current and voltage variables. Particularly in the frequency domain, the absolute phase of the quantities can be arbitrary. This indeterminacy can have an impact on the solution process. See [Compile Equations](#) in the *COMSOL Multiphysics Reference Manual* for a possible solution to this problem.

Initial Values

The initial values subsection is used to provide initial values for the internal state variables in the Terminal. These settings can be useful to provide an initial guess to the nonlinear solver or the initial value in a time-dependent study when the initial values

of the other dependent variables (such as the electric potential) are computed from a separate physics or study. In most cases, the default values are appropriate.

The **Initial value for voltage** is available for all Terminal types except Voltage. Enter an **Initial value for voltage** V_{init} (SI unit: V). The default is 0 V.

The **Initial value for current** is available for Power only. In this case, it provides an initial guess for the nonlinear solver, and should not be set to zero. The initial value provided may affect the solution. Enter an **Initial value for current** I_{init} (SI unit: A). The default is 1 mA.

CONSTRAINT SETTINGS

To display this section, click the **Show More Options** button () and select **Advanced Physics Options** in the **Show More Options** dialog box.



Lumped Parameters

Electric Shielding

The **Electric Shielding** node provides an electric shielding boundary condition. Use this node to model a thin layer of a highly conductive medium that shields the electric field. The sheet has the electrical conductivity σ_s and the surface thickness d .

The condition is represented by the following equation for interior boundaries and (setting $\mathbf{J}_2 = 0$) exterior boundaries assuming DC currents

$$\mathbf{n} \cdot (\mathbf{J}_1 - \mathbf{J}_2) = -\nabla_t \cdot d(\sigma_s \nabla_t V)$$

For the frequency domain and Time Dependent study types, also displacement currents are accounted for via the bulk relative permittivity of the sheet; ϵ_{rs} and the conservation laws change to:

$$\begin{aligned} \mathbf{n} \cdot (\mathbf{J}_1 - \mathbf{J}_2) &= -\nabla_t \cdot d((\sigma_s + j\omega\epsilon_0\epsilon_{rs})\nabla_t V) \\ \mathbf{n} \cdot (\mathbf{J}_1 - \mathbf{J}_2) &= -\nabla_t \cdot d\left(\sigma_s \nabla_t V + \epsilon_0\epsilon_{rs} \frac{\partial}{\partial t} \nabla_t V\right) \end{aligned}$$

Use this boundary condition when approximating a thin domain with a boundary to reduce the number of mesh elements. The **Electric Field** and **Conduction Current** sections are the same as for [Current Conservation](#).

THICKNESS

Enter a value or expression for the **Surface thickness** d_s (SI unit: m). The default is 1 cm.



Electric Shielding: Application Library path
ACDC_Module/Resistive_Devices/electric_shielding

Contact Impedance

Use the **Contact Impedance** node on interior boundaries to model a thin layer of resistive material. It can also be added as a pair using a **Pair Contact Impedance** node. The feature allows specifying the contact impedance either by entering the properties of the material together with the layer thickness, or by entering the impedance properties of the thin layer directly.

The feature, in stationary studies, applies the following conditions that relate the normal electric current density with the jump in the electric potential:

$$\mathbf{n} \cdot \mathbf{J}_1 = \frac{\sigma}{d_s}(V_1 - V_2)$$

$$\mathbf{n} \cdot \mathbf{J}_2 = \frac{\sigma}{d_s}(V_2 - V_1)$$

$$\mathbf{n} \cdot \mathbf{J}_1 = \frac{1}{\rho_s}(V_1 - V_2)$$

$$\mathbf{n} \cdot \mathbf{J}_2 = \frac{1}{\rho_s}(V_2 - V_1)$$

The first two equations refer to a layer impedance specified using the bulk material conductivity σ_s and the layer thickness d_s , while the last two equations refer to the case in which the surface resistance ρ_s is specified. The indices 1 and 2 refer to the two sides of the boundary. These parameters work the same as with [Distributed Impedance](#).

For the frequency domain and Time Dependent study types, this boundary condition is slightly more sophisticated and accounts also for capacitive coupling. The bulk material relative permittivity ϵ_r or the layer capacitance C_s can be specified.

The equations used in Frequency Domain studies are:

$$\mathbf{n} \cdot \mathbf{J}_1 = \frac{(\sigma + j\omega\epsilon_0\epsilon_r)}{d_s}(V_1 - V_2)$$

$$\mathbf{n} \cdot \mathbf{J}_2 = \frac{(\sigma + j\omega\epsilon_0\epsilon_r)}{d_s}(V_2 - V_1)$$

$$\mathbf{n} \cdot \mathbf{J}_1 = \left(\frac{1}{\rho_s} + j\omega C_s\right)(V_1 - V_2)$$

$$\mathbf{n} \cdot \mathbf{J}_2 = \left(\frac{1}{\rho_s} + j\omega C_s\right)(V_2 - V_1)$$

In Time Dependent studies:

$$\mathbf{n} \cdot \mathbf{J}_1 = \frac{1}{d_s} \left(\sigma(V_1 - V_2) + \epsilon_0\epsilon_r \frac{\partial}{\partial t}(V_1 - V_2) \right)$$

$$\mathbf{n} \cdot \mathbf{J}_2 = \frac{1}{d_s} \left(\sigma(V_2 - V_1) + \epsilon_0\epsilon_r \frac{\partial}{\partial t}(V_2 - V_1) \right)$$

$$\mathbf{n} \cdot \mathbf{J}_1 = \left(\frac{1}{\rho_s}(V_1 - V_2) + C_s \frac{\partial}{\partial t}(V_1 - V_2) \right)$$

$$\mathbf{n} \cdot \mathbf{J}_2 = \left(\frac{1}{\rho_s}(V_2 - V_1) + C_s \frac{\partial}{\partial t}(V_2 - V_1) \right)$$

CONTACT IMPEDANCE

Select a potentially complex-valued **Layer specification** — **Thin layer** (the default) or **Surface impedance**.

- For **Thin layer**, enter values or expressions for the:
 - **Surface thickness** d_s (SI unit: m). The default is $5 \cdot 10^{-3}$ m (5 mm).
 - **Electrical conductivity** σ (SI unit: S/m) and **Relative permittivity** ϵ_r (dimensionless). The defaults take values **From material**. For **User defined**, enter different values or expressions. The default electrical conductivity is $1 \cdot 10^{-2}$ S/m and the default relative permittivity is 1.
- For **Surface impedance**, enter values or expressions for the **Surface resistance** ρ_s (SI unit: $\Omega \cdot \text{m}^2$) and the **Surface capacitance** C_s (SI unit: F/m^2). The default surface impedance is $1 \cdot 10^{-8}$ $\Omega \cdot \text{m}^2$ and the default surface capacitance is 0 F/m^2 .



Thin-Film Resistance: Application Library path

COMSOL_Multiphysics/Electromagnetics/thin_film_resistance

Electrical Contact

The **Electrical Contact** node defines correlations for the conductance h at the interface of two bodies in an imperfect contact due to the surface roughness. It can be added to pairs by selecting **Pair Electrical Contact** from the **Pairs** menu.

The conductance h is involved in the current flow across the surfaces in contact according to:

$$\mathbf{n} \cdot \mathbf{J}_1 = -h_c(V_1 - V_2)$$

$$\mathbf{n} \cdot \mathbf{J}_2 = -h_c(V_2 - V_1)$$

where indices 1 and 2 refer to the two sides of the boundary.

ELECTRICAL CONTACT

Select the **Constriction conductance** — **Cooper-Mikic-Yovanovich correlation** (the default), **Mikic elastic correlation**, or **User defined**. For **User defined** enter a value or expression for h_c (SI unit: S/m²). The default is 0 S/m².

CONTACT SURFACE PROPERTIES

This section displays if **Cooper-Mikic-Yovanovich correlation** or **Mikic elastic correlation** are chosen under **Contact**.

Enter values for the:

- **Surface roughness, asperities average height** σ_{asp} (SI unit: m). The default is 1 μm .
- **Surface roughness, asperities average slope** m_{asp} (dimensionless). The default is 0.4.
- **Contact pressure** p (SI unit: Pa). The default is 0 Pa.

For **Cooper-Mikic-Yovanovich correlation** select a **Hardness definition** — **Microhardness** (the default), **Vickers hardness**, or **Brinell hardness**.

- For **Microhardness** enter a value for H_c (SI unit: Pa). The default is 3 GPa.
- For **Vickers hardness** enter a value for the **Vickers correlation coefficient** c_1 (SI unit: Pa) and **Vickers size index** c_2 (dimensionless). The defaults are 5 GPa and -0.1 , respectively.
- For **Brinell hardness** enter a value for H_B (SI unit: Pa). The default is 3 GPa. H_B should be between 1.30 and 7.60 GPa.

For **Mikic elastic correlation** select the **Contact interface Young's modulus** E_{contact} — **Weighted harmonic mean** (the default) or **User defined**.

- For **Weighted harmonic mean**, enter values or expressions for the **Young's modulus, upside**, E_u (SI unit Pa), the **Young's modulus, downside**, E_d (SI unit Pa), the **Poisson's ratio, upside**, ν_u (dimensionless), and the **Poisson's ratio, downside**, ν_d (dimensionless). If this node is selected from the **Pairs** menu, enter instead values or expressions for the **Young's modulus, source**, E_{src} (SI unit Pa), the **Young's modulus, destination**, E_{dst} (SI unit Pa), the **Poisson's ratio, source**, ν_{src} (dimensionless), and the **Poisson's ratio, destination**, ν_{dst} (dimensionless). The defaults are 0.
- For **User defined** enter another value or expression for the **Contact interface Young's modulus** E_{contact} (SI unit: Pa). The default is 1 GPa.



Theory for Electrical Contact

Sector Symmetry

Select **Sector Symmetry** at interfaces between rotating objects where sector symmetry is used. It is only available for pairs. A default subnode is added. Right-click to select additional features from the **Fallback Features** submenu. In 2D, this feature assumes rotation around the origin.



This feature is always used in conjunction with a [Periodic Condition](#) on adjacent radial sector boundaries. Note that the same periodic condition feature cannot be used on both sides of where the sector symmetry boundaries connect with the periodic boundaries. At least two periodic condition features are required for the model to compute correctly.

PAIR SELECTION

When using nonconforming meshes on the source and destination of a pair, for numerical stability, a finer mesh should be applied on the destination side for any pair with a condition that imposes a coupling or a constraint across the pair. The sector symmetry feature falls into this category.

SECTOR SETTINGS

Enter the **Number of sectors (<50)** n_{sect} . The default is 2.

Select a **Type of periodicity** — **Continuity** (the default) or **Antiperiodicity**.

Based on space dimension, enter values or expressions in the table for the **Axis of rotation** \mathbf{a}_{rot} .

CONSTRAINT SETTINGS

To display this section, click the **Show More Options** button () and select **Advanced Physics Options** in the **Show More Options** dialog box.

Line Current Source

The **Line Current Source** node adds a line source to edges in 3D components and to points in 2D and 2D axisymmetric components. The line source represents electric current per unit length.

EDGE OR POINT SELECTION



Beware that constraining the potential on edges or points usually yields a current outflow that is mesh dependent.

LINE CURRENT SOURCE

Enter a value or expression to apply a **Line current source** Q_j (SI unit: A/m). This source represents electric current per unit length. The default is 0 A/m.



[Line Current Source \(on Axis\)](#) for 2D axisymmetric components.

Line Current Source (on Axis)

The **Line Current Source (on Axis)** node adds a line source to boundaries in 2D axisymmetric components. The line source represents electric current per unit length.

LINE CURRENT SOURCE (ON AXIS)

Enter a value or expression to apply a **Line current source** Q_j (SI unit: A/m) to boundaries. This source represents electric current per unit length.



Line Current Source

Point Current Source

The **Point Current Source** node adds a point source and represents an electric current flowing out of the point. Add point sources to 3D components from the **Points** menu. Add a contribution as a **Harmonic Perturbation** by right-clicking the parent node or clicking **Harmonic Perturbation** on the **Physics** toolbar. For more information see [Harmonic Perturbation — Exclusive and Contributing Nodes](#) in the *COMSOL Multiphysics Reference Manual*.

POINT SELECTION



Beware that constraining the potential on points usually yields a current outflow that is mesh dependent.

POINT CURRENT SOURCE

Enter a value or expression to apply a **Point current source** Q_j (SI unit: A) to points. This source represents an electric current flowing out of the point.



- [Line Current Source](#) for 2D components
 - [Point Current Source \(on Axis\)](#) for 2D axisymmetric components
-

Point Current Source (on Axis)

The **Point Current Source (on Axis)** node adds a point source and represents an electric current flowing out of the point in 2D axisymmetric components.

POINT SELECTION



Beware that constraining the potential on points usually yields a current outflow that is mesh dependent.

POINT CURRENT SOURCE

Enter a value or expression to apply a **Point current source** Q_j (SI unit: A) to points. This source represents an electric current flowing out of the point.



- [Point Current Source](#) for 3D components
- [Line Current Source](#) for 2D components

Electric Point Dipole

The **Electric Point Dipole** node, available for 2D and 3D components, represents the limiting case of zero separation distance between two equally strong point current sources and current sinks of opposing signs while maintaining the product between separation distance and source strength at a fixed value (P). The positive direction is from the current sink to the current source.

DIPOLE SPECIFICATION

Select a **Dipole specification** — **Magnitude and direction** (the default) or **Dipole moment**.

DIPOLE PARAMETERS

Under **Dipole Specification**:

- For **Magnitude and direction** enter coordinates for the **Electric current dipole moment direction** \mathbf{n}_p and the **Electric current dipole moment, magnitude** p (SI unit: A·m).
- For **Dipole moment** enter the components of the **Electric current dipole moment** \mathbf{p} (SI unit: A·m).



[Electric Point Dipole \(on Axis\)](#)

Electric Point Dipole (on Axis)

The **Electric Point Dipole (on Axis)**, available for 2D axisymmetric components, represents the limiting case of zero separation distance between two equally strong point current sources and current sinks of opposing signs while maintaining the product between separation distance and source strength at a fixed value (P). The positive direction is from the current sink to the current source.

ELECTRIC POINT DIPOLE (ON AXIS)

Enter the **Electric current dipole moment in z direction** p_z (SI unit: A·m).



Electric Point Dipole

Piezoresistive Material

The **Piezoresistive Material** is normally used together with a **Piezoresistive Effect, Domain Currents** multiphysics coupling node. The node is added by default to the **Electric Currents** interface when adding a **Piezoresistivity, Domain Currents** predefined multiphysics coupling interface. It is also available from the context menu (right-click the **Electric Currents** interface parent node) or from the **Physics** toolbar.



When the **Piezoresistive Material** node is added to the Electric Currents interface in the absence of an active **Piezoelectric Effect, Domain Currents** multiphysics coupling node, the material behaves similarly to a **Current Conservation** node, with electric properties corresponding to the relative permittivity and electrical conductivity entered. The piezoresistive effect is *not* included in the corresponding equation system.

PIEZORESISTIVE MATERIAL PROPERTY

This node should be used together with an active **Piezoresistive Effect, Domain Currents** multiphysics coupling node. Select a **Constitutive model** — **Piezoresistance form** or **Elastoresistance form**. For each of the following, the default uses values **From material**. For **User defined** enter other values in the matrix or field.

- Specify a **Electrical conductivity, zero stress** (SI unit: S/m). This typically comes from the material added under the Materials node.

- For **Piezoresistance form**, select a **Piezoresistance coupling matrix Π_l**
(SI unit: $\text{m}^4/(\text{s}\cdot\text{A}^2)$); note that this is equivalent to $\Omega\cdot\text{m}/\text{Pa}$).
- For a **Elastoresistance form**, select an **Elastoresistance coupling matrix M_l**
(SI unit: $\Omega\cdot\text{m}$).

The Electric Currents in Shells Interface

The **Electric Currents in Shells (ecis)** interface () , found under the **AC/DC>Electric Fields and Currents** branch when adding a physics interface, is used to compute electric fields, currents, and potential distributions in thin conducting layered shells under conditions where inductive effects are negligible; that is, when the skin depth is much larger than the studied device. It supports stationary, time-dependent and frequency domain modeling on faces in 3D.

The electric potential can be located either on the selected surface or in a product space spanned by the surface and the physical thickness of the shell (using an extra dimension). For conductive shells, the physics interface solves a current conservation equation based on Ohm's law using the scalar electric potential as the dependent variable. For dielectric layers the interface solves Gauss' law (it effectively turns into a local Electrostatics interface).

The Electric Currents in Shells interface is very similar to [The Electric Currents in Layered Shells Interface](#). The main difference is the default mode. [The Electric Currents in Layered Shells Interface](#) is set to be *layered* by default, while the Electric Currents in Shells interface is set to be *nonlayered* by default.



This interface supports layered shell features, which means each boundary in the 3D geometry may represent a number of thin layers with different electrical properties. Potential variations in the normal direction (in between and inside layers) are supported. For a general description of layer and interface selections, see [Layer and Interface Selection Tools](#). For more information, see the section on how to set up a [Layered Material](#) node in the *COMSOL Multiphysics Reference Manual*.



For a more extensive introduction to the physics and equations implemented by this physics interface, see [The Electric Currents Interface](#), and the [Theory for the Electric Currents Interface](#). Additional information is available in [Theory for the Electrostatics Interface](#) chapter and [The Electric Currents, Single Layer Shell Interface](#) chapter.

SETTINGS

The **Label** is the default physics interface name.

The **Name** is used primarily as a scope prefix for variables defined by the physics interface. Refer to such physics interface variables in expressions using the pattern `<name>.<variable_name>`. In order to distinguish between variables belonging to different physics interfaces, the `name` string must be unique. Only letters, numbers and underscores (`_`) are permitted in the **Name** field. The first character must be a letter.

The default **Name** (for the first physics interface in the model) is `ecis`.

BOUNDARY SELECTION

By default, all boundaries are available for the application of [The Electric Currents in Shells Interface](#). Select the **Restrict to layered boundaries** check box to make the interface applicable only if a layered material is defined on the boundary. If a layered material (**Material** with **Layer thickness** specified, **Single Layer Material**, **Layered Material Link**, or **Layered Material Stack**) is available, its name is then displayed beside the boundary index (for example, `s1mat1`), otherwise the boundary is marked as not applicable.

SHELL PROPERTIES

The default setting of the combo box **Shell type** is the main difference between [The Electric Currents in Shells Interface](#) and [The Electric Currents in Layered Shells Interface](#), where the former is set to be **Nonlayered shell** by default and the later is set to be **Layered shell** by default.

When the **Nonlayered shell** option is selected, the interface treats the thickness as a multiplicative factor which enters the conservation of surface currents.

- If the **Restrict to layered boundaries** check box is not selected in the **Boundary Selection** section, a nonlayered material may be defined on the selected boundaries, and the **Thickness** L_{th} can be set as a user defined value or expression. This value overrides the values set in the material nodes.
- You can visualize the selected layered materials and layers in each layered material by clicking the **Layer cross section preview** and **Layer 3D preview** buttons.

When the **Layered shell** option is selected, the Extra Dimension tool is used to solve the equations through the thickness of a layered material. Depending on other settings, it can describe the physics of objects where electric potential vary both tangentially and perpendicularly (through the thickness).

The thickness of the layered material should be set as follows, depending on the type of material:

- In a **Material** node, the **Layer thickness** can be in the table found under the **Material Contents** section of the material **Settings** window. This automatically adds a **Shell** subnode under the **Material** node, transforming it as a layered material.
- When the layered material is a **Single Layer Material**, the **Thickness** is set in the **Layer Definition** section of the **Shell Property Group** window.
- For a general **Layered Material**, added through a **Layered Material Link** or a **Layered Material Stack**, the **Thickness** is set in the **Layer Definition** section of the **Settings** window. Several layers may be defined in the table, and the **Thickness** should be defined for each of them. The total thickness of the layered material is the sum of all the layers thicknesses.

Note that the **Layered shell** option should be used whenever a layered material is applied on the boundaries, because the thickness is part of the material settings.

Clear the **Use all layers** check box to apply [The Electric Currents in Shells Interface](#) on some layers only. Select a **Layered material** from the list (the interface is then applicable only on the boundaries where this latter material is defined), and clear the check boxes corresponding to layers where the interface should not be applied in the **Selection** table.



- The layer thickness variable, `ecis.ds`, used in the weak equations, is the product of the thickness set in the **Shell Properties** section, `ecis.lth`, and the scale factor `ecis.lsc`, which is equal to 1 by default, and can be overridden by a user defined value in a single layer material.
- The layer thickness variable, `ecis.ds`, is defined in all dimensions, and is unrelated to the **Out-of-plane thickness** of the layered material, `htlsh.d`, which is only available in 2D.



- See [Layer and Interface Selection Tools](#).
- You can provide material parameters with a through-thickness variation by explicitly or implicitly using expressions containing the extra dimension coordinate as described in [Using the Extra Dimension Coordinates](#).



The desired selection for the physics interface may correspond to boundaries with different layered materials. This means that a single physics interface can accommodate several different stacking sequences.

See [Layered Material](#), [Layered Material Link](#), [Layered Material Stack](#), [Layered Material Link \(Subnode\)](#), and [Single-Layer Materials](#) in the *COMSOL Multiphysics Reference Manual* for details on the definition of layered materials.

DISCRETIZATION

The discretization order is set to **Quadratic** by default.

DEPENDENT VARIABLES

The dependent variable is for the **Electric potential** V . The name can be changed but the names of fields and dependent variables must be unique within a model.

Layer and Interface Selection Tools

Almost all physics nodes that you add in [The Electric Currents in Shells Interface](#) have either a section named **Shell Properties**, or **Layer Selection** or **Interface Selection**. Selections there interact with the standard selections of geometrical objects (boundaries and edges) in order to provide a complete specification of where a material property or boundary condition is to be applied within a layered material.

The physics features can be of two, fundamentally different, types: those who act on the layers themselves, and those who act on the interfaces between layers. The settings for these two types of features are slightly different.

LAYER SELECTIONS

When a physics feature acts on layers, the interpretations of layer selections are:

- A boundary selection in the geometry corresponds to a domain contribution in the selected layers.
- An edge selection in the geometry corresponds to boundary contributions on the faces of the layers exposed to that edge.

This is illustrated by [Figure 4-1](#) and [Figure 4-2](#), where the patch at the lower left is the actual shell, and the 3D sketch shows an expanded view of what it would represent in the physical world.

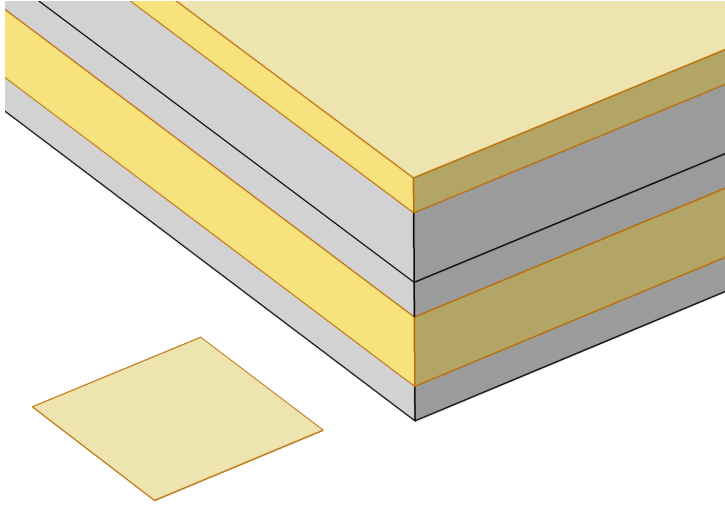

Figure 4-1: Boundary selection with layers 2 and 5 selected.

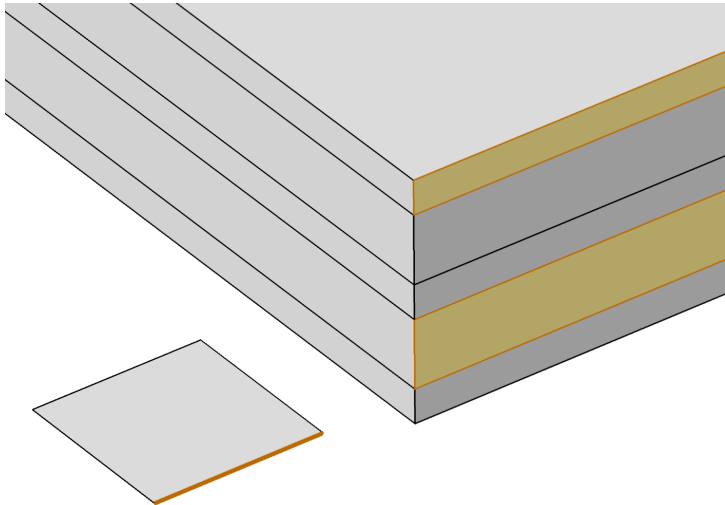

Figure 4-2: Edge selection with layers 2 and 5 selected.

In the **Shell Properties** section, it is possible to limit the contributions to individually selected layers of the selections made in the **Boundary Selection** section. For a given **Layered Material Link**, **Layered Material Stack**, or **Single Layer Material**, you get access to a list of check boxes for the selection of the individual layers.

INTERFACE SELECTIONS

When a physics feature acts on interfaces, the interpretation of interface selections are:

- A boundary selection in the geometry corresponds to boundary contributions on the selected interfaces.
- An edge selection in the geometry corresponds to edge contributions on the interface edges parallel to the selected edge.

This is illustrated by [Figure 4-3](#) and [Figure 4-4](#), where the patch at the lower left is the actual shell, and the 3D sketch shows an expanded view of what it would represent in the physical world.

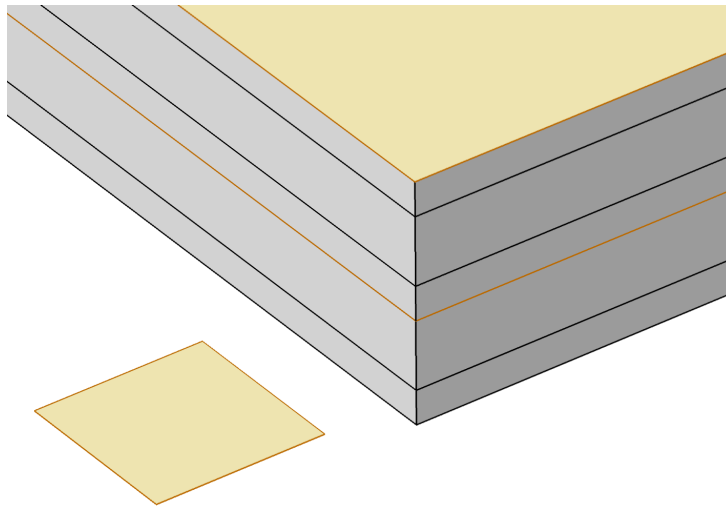

Figure 4-3: Boundary selection with interfaces 'layer 2 - layer 3' and 'layer 5 up' selected.

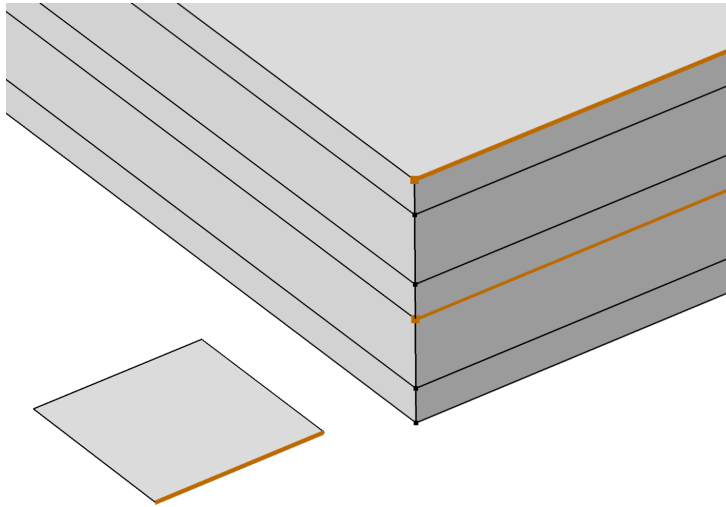

Figure 4-4: Edge selection with interfaces 'layer 2 - layer 3' and 'layer 5 up' selected.

In the **Interface Selection** section, it is possible to select the interfaces between layers where the contribution should be added, including the top and bottom interfaces (see [Figure 4-5](#) for the interfaces description). For a given **Layered Material Link**, **Layered**

Material Stack, or **Single Layer Material**, you get access to a list of predefined interfaces subsets.

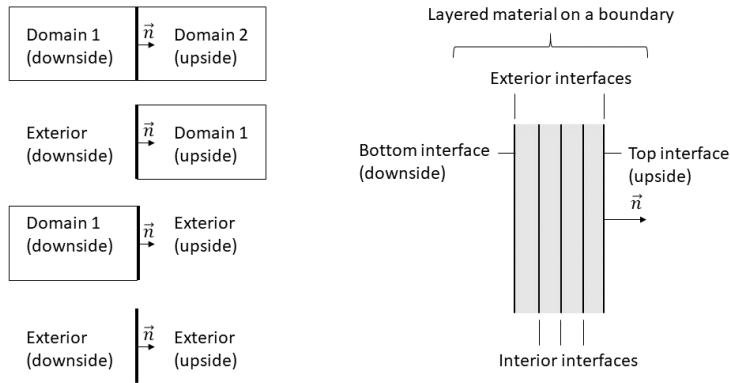

Figure 4-5: Definition of upside and downside settings for a boundary for different configurations, and corresponding interfaces for a layered material.



See [Layered Material](#), [Layered Material Link](#), [Layered Material Stack](#), [Layered Material Link \(Subnode\)](#), and [Single-Layer Materials](#) in the *COMSOL Multiphysics Reference Manual*.

Using the Extra Dimension Coordinates

It is possible to write expressions that are functions of the coordinates in the thickness direction of the shell. Expressions based on the usual coordinates, like x , y , and z , are evaluated on the reference surface (the meshed boundaries). In addition to this, the locations in the through-thickness direction can be accessed by making explicit or implicit use of the coordinates in the extra dimension.

The extra dimension coordinate has a name like `x_11mat1_xdim`. The middle part of the coordinate name is derived from the tag of the layered material definition where it is created; in this example a **Layered Material Link**.

Boundary and Edge Nodes for the Electric Currents in Shells Interface

The [Electric Currents in Shells Interface](#) has these boundary and edge nodes available from the **Physics** ribbon toolbar (Windows users), **Physics** context menu (Mac or Linux users), or right-click to access the context menu (all users).



In general, to add a node, go to the **Physics** toolbar, no matter what operating system you are using. Subnodes are available by clicking the parent node and selecting it from the **Attributes** menu.

ABOUT THE EDGE CONDITION SELECTIONS

The edge conditions available in [The Electric Currents in Shells Interface](#) are applicable to exterior edges only. For shell interfaces, *exterior* means exterior to the boundary selection. In other words; an edge that is connected to adjacent boundaries, only on one side. Consequently, an edge can be regarded as interior (and therefore, not applicable), even though it is *exterior* to the domain that is enclosed by the shell boundary selection. See [Layer and Interface Selection Tools](#) for more information.

AVAILABLE NODES

These nodes and subnodes are described in this section:

- [Conductive Shell](#)
- [Insulating Layer](#)
- [Boundary Current Source](#)
- [Interface Current Source](#)
- [Interlayer Connection](#)
- [Dielectric Layer](#)
- [Piezoelectric Layer](#)
- [Continuity \(Layered Shell\)](#)

These nodes are available for this physics interface and described for the Electric Currents and Electrostatics interfaces (listed in alphabetical order):

- [Current Source](#)
- [Electric Insulation](#)
- [Electric Potential](#)
- [External Current Density](#)
- [Ground](#)
- [Normal Current Density](#)
- [Terminal](#)

Conductive Shell

The **Conductive Shell** node is the default feature [The Electric Currents in Shells Interface](#). Its property depends on if the **Shell type** in the physics interface is set to **Nonlayered shell** or **Layered shell**. See the description of **Shell Properties** at the beginning of [The Electric Currents in Shells Interface](#) chapter for more information. Generally, the node adds the continuity equation for the electric potential and allows for defining the electric conductivity of the layers. This feature closely relates to [Current Conservation](#) under [The Electric Currents Interface](#).

LAYER MODEL

When the **Shell Type** is set to **Layered shell**, by default the **Layer Model** is set to **General** which considers a full equivalent 3D representation of the model. For this case, the **Layer Model** section provides an extra option **Highly conductive layer**. By selecting the **Highly conductive layer**, the feature enforces the potential to be constant through the thickness of the selected layers. For conducting layers where very small electric potential gradients exist in the perpendicular direction, such a setting could increase numerical stability.

Insulating Layer

The **Insulating Layer** offers the option to not have any current through the selected layer, which is equivalent to removing the physics from the selected layer from the 3D point of view. See [Layer and Interface Selection Tools](#) for more information about how to select a layer.

Boundary Current Source

The **Boundary Current Source** node adds a current source Q_j on the boundary.

$$\mathbf{t} \cdot (\mathbf{J}_1 - \mathbf{J}_2) = Q_{j,s}$$

It is applicable to interior boundaries that represent either a source or a sink of current.

BOUNDARY CURRENT SOURCE

Enter a value or expression for the **Boundary current source** $Q_{j,s}$ (SI unit: A/m²). The default is 0 A/m².

Interface Current Source

The **Interface Current Source** is available for boundaries only. Instead of representing a source interior to the layer, or a source on the layer's outer perimeter, it represents a net current density flowing from the adjacent domain into the shell ($Q_{j,s}$, SI unit: A/m^2). It can be used to model, for example, a boundary acting as an electrode. Alternatively, for interior interface selections it may represent a source of current on an interface in-between layers.

In the 3D representation of the layer stack, you could consider it a **Boundary Current Source** applied to either the top or bottom of the layer stack, or on an interface in-between layers. For more information on the 3D representation of the layer stack, see [Layer and Interface Selection Tools](#).



Use this node with caution as it might violate the current conservation law that is inherent in Maxwell-Ampère's law.

INTERFACE SELECTION

Select the interfaces for which the source contribution should be added.



For a general description of layer and interface selections, see [Layer and Interface Selection Tools](#).

INTERFACE CURRENT SOURCE

Enter a value or expression for the **Current source** $Q_{j,s}$ (SI unit: A/m^2). The default is $0 A/m^2$.

Interlayer Connection

The **Interlayer Connection** is available only on edges, where it removes for the selected layers, the potential gradient in the perpendicular direction (in the direction of the *extra dimension*). The layers will become electrically connected, and the top and bottom of all involved layers will have the same potential. Multiple **Interlayer Connection** features can be applied to create groups of connected layers.

An **Interlayer Connection** on a single layer can be used to locally convert the full 3D formulation into an in-plane conservation problem. For thin highly conductive layers, this is numerically more stable.

SHELL PROPERTIES

For a general description of layer and interface selections, see [Layer and Interface Selection Tools](#).

CONSTRAINT SETTINGS

To display this section, click the **Show More Options** button () and select **Advanced Physics Options**.

Dielectric Layer

The **Dielectric Layer** feature is only available for **Layered Shell**. The node adds the Poisson's equation for the electric potential and allows for defining the electric permittivity of the layers. This feature closely relates to [Charge Conservation](#) under [The Electrostatics Interface](#).

Piezoelectric Layer

The **Piezoelectric Layer** feature is an extension of the [Dielectric Layer](#). It offers the option to have multiphysics coupling with the corresponding **Layered Shell** physics interface node to model piezoelectric devices.

Continuity (Layered Shell)

The **Continuity** feature is only available for the interface where the **Layer Type** sets to **Layered Shell**. Use this node to specify the side-by-side continuity conditions on the electric potential at an edge between two layered materials. By default, the electric potential is discontinuous at the interface between two layered materials.

LAYER SELECTION

Select **Source** and **Destination** layered materials from the drop-down lists. This makes the node applicable on the edges adjacent to both selected layered materials. Click the **Layer Cross Section Preview** button to visualize the settings.

CONSTRAINT SETTINGS

To display this section, click the **Show More Options** button () and select **Advanced Physics Options**.

The Electric Currents in Layered Shells Interface

The **Electric Currents in Layered Shells (ecis)** interface () , found under the **AC/DC>Electric Fields and Currents** branch when adding a physics interface, is used to compute electric field, current, and potential distributions in thin and thick conductive shells and dielectrics, optionally with an internal layered structure. Inductive effects are assumed to be negligible; that is, the skin depth should be much larger than the studied device. It supports stationary, time-dependent and frequency domain modeling on faces in 3D.

The Electric Currents in Layered Shells interface is very similar to [The Electric Currents in Shells Interface](#). The main difference is the default mode. [The Electric Currents in Shells Interface](#) is set to be nonlayered by default, while the Electric Currents in Layered Shells interface is set to be layered by default.



For a more extensive introduction to the physics interface, see [The Electric Currents in Shells Interface](#) chapter.

The Electric Currents, Single Layer Shell Interface

The **Electric Currents, Single Layer Shell (ecs)** interface () is found under the **AC/DC>Electromagnetics and Mechanics>Piezoresistivity** branch when adding a physics interface, is a legacy interface used to compute electric field, current, and potential distributions in thin conducting shells under conditions where inductive effects are negligible; that is, when the skin depth is much larger than the studied device. It supports stationary, frequency-domain, small-signal analysis, and time-domain modeling on edges in 2D and faces in 3D



In earlier version this interface was called **Electric Currents, Shell**. It has been replaced by [The Electric Currents in Shells Interface](#), which is found under the **AC/DC** branch ()

The physics interface solves a current conservation equation based on Ohm's law using the scalar electric potential as the dependent variable.

[Current Conservation](#) is the main node, which adds the equation for the electric potential and provides a Settings window for defining the electrical conductivity as well as the constitutive relation for the electric displacement field and its associated material properties such as the relative permittivity.

When this physics interface is added, these default nodes are also added to the **Model Builder**— **Current Conservation**, **Electric Insulation** (the default edge or point condition), and **Initial Values**. Then, from the **Physics** toolbar, add other nodes that implement, for

example, edge or point conditions and current sources. You can also right-click **Electric Currents, Single Layer Shell** to select physics features from the context menu.



Except where described here, the majority of the **Settings** windows are the same as for the Electrostatics and Electric Currents interfaces as referenced. The only difference are:

- For 3D components, boundaries are selected instead of domains, and edges instead of boundaries.
- For 2D and 2D axisymmetric components, boundaries are selected instead of domains, and points instead of edges and boundaries.



For a more extensive introduction to the physics and equations implemented by this physics interface, see the [Theory for the Electric Currents, Single Layer Shell Interface](#).

SETTINGS

The **Label** is the default physics interface name.

The **Name** is used primarily as a scope prefix for variables defined by the physics interface. Refer to such physics interface variables in expressions using the pattern `<name>.<variable_name>`. In order to distinguish between variables belonging to different physics interfaces, the `name` string must be unique. Only letters, numbers and underscores (`_`) are permitted in the **Name** field. The first character must be a letter.

The default **Name** (for the first physics interface in the model) is `ecs`.

OUT-OF-PLANE THICKNESS



For 2D components, enter a value or expression for the **Thickness** d . The default value is 1 unit length.

Use the [Change Thickness \(Out-of-Plane\)](#) node to define specific boundaries or points instead of a global setting for the thickness.

SHELL THICKNESS

Enter a value or expression for the **Shell thickness** d_s (SI unit: m). The default value is 1 cm.



When modeling with shells, the **Shell Thickness** section defines a parameter that enters the equations everywhere. It is available in all dimensions.

This is unrelated to the **Change Thickness (Out-of-Plane)** node, which is only available in 2D and represents the out-of-plane length of the shell, which is being modeled as a cross-section.

When modeling in 2D, this means that on the physics interface **Settings** window, there are two sections — the **Shell Thickness** and **Out-of-Plane Thickness** — available, as well as two feature nodes — **Change Shell Thickness** and **Change Thickness (Out-of-Plane)**.

MANUAL TERMINAL SWEEP SETTINGS

Enter a **Reference impedance** Z_{ref} (SI unit: Ω). The default is 50 Ω .

Select the **Activate manual terminal sweep** check box to switch on the sweep and invoke a parametric sweep over the terminals. Enter a **Sweep parameter name** to assign a specific name to the variable that controls the terminal number solved for during the sweep. The default is PortName. The generated lumped parameters are in the form of capacitance matrix elements. The terminal settings must consistently be of either fixed voltage or fixed charge type.

The lumped parameters are subject to **Touchstone file export**. Enter a file path or **Browse** for a file. Select a **Parameter format (value pairs)** for the Touchstone export — **Magnitude and angle (MA)** (the default), **Magnitude in dB and angle (DB)**, or **Real and imaginary parts (RI)**. Select an option from the **If file exists** list — **Overwrite** or **Create new**. Select a **Parameter to export** — **Z** (the default), **Y**, or **S**.

DEPENDENT VARIABLES

The dependent variable (field variable) is for the **Electric potential** V . The name can be changed but the names of fields and dependent variables must be unique within a model.

DISCRETIZATION



- [Lumped Parameters](#)
- [Boundary, Edge, Point, and Pair Nodes for the Electric Currents, Single Layer Shell Interface](#)

Boundary, Edge, Point, and Pair Nodes for the Electric Currents, Single Layer Shell Interface

The [Electric Currents, Single Layer Shell Interface](#) has these boundary, edge, point, and pair nodes available from the **Physics** ribbon toolbar (Windows users), **Physics** context menu (Mac or Linux users), or right-click to access the context menu (all users).



In general, to add a node, go to the **Physics** toolbar, no matter what operating system you are using. Subnodes are available by clicking the parent node and selecting it from the **Attributes** menu.

ABOUT THE EDGE AND POINT CONDITIONS

The nodes in [Table 4-1](#) are available at interfaces between different media and interior edges (in 3D components) and point conditions (in 2D and 2D axisymmetric components) in continuity; that is,

$$\mathbf{n}_2 \cdot (\mathbf{J}_1 - \mathbf{J}_2) = 0$$

which is the natural edge/point condition.

AVAILABLE NODES

These nodes and subnodes are described in this section:

- [Change Shell Thickness](#)
- [Current Conservation](#)
- [Current Source](#)
- [Electric Shielding](#)
- [Initial Values](#)
- [Normal Current Density](#)

These nodes are available for this physics interface and described for the Electric Currents and Electrostatics interfaces (listed in alphabetical order):

- Archie's Law
- Boundary Current Source
- Change Thickness (Out-of-Plane)
- Current Source
- Distributed Impedance
- Effective Medium
- Electric Insulation
- Electric Point Dipole
- Electric Potential
- External Current Density
- Ground
- Initial Values
- Line Current Source
- Point Current Source
- Terminal

Current Conservation

The **Current Conservation** node adds the continuity equation for the electrical potential and provides an interface for defining the electric conductivity as well as the constitutive relation and the relative permittivity for the displacement current.

MATERIAL TYPE

The **Material type** setting decides how materials behave and how material properties are interpreted when the mesh is deformed. Select **Solid** for materials whose properties change as functions of material strain, material orientation and other variables evaluated in a material reference configuration (material frame). Select **Nonsolid** for materials whose properties are defined only as functions of the current local state at each point in the spatial frame, and for which no unique material reference configuration can be defined. Select **From material** to pick up the corresponding setting from the domain material on each domain.

ELECTRIC FIELD

See **Electric Field** as described for the [Charge Conservation](#) node for the Electrostatics interface.

CONDUCTION CURRENT

By default, the **Electrical conductivity** σ (SI unit: S/m) for the media is defined **From material**. Or select **User defined**, **Linearized resistivity**, **Effective medium**, or **Archie's law**.



Note that general anisotropy is not supported. The boundary orientation has to be normal to one of the principal directions of the material tensor, that is parallel to a plane spanned by the two other principal directions. Violating this condition will result in incorrect results without any warning or error message.

User Defined

For **User defined** select **Isotropic**, **Diagonal**, **Symmetric**, or **Full** depending on the characteristics of the electrical conductivity, and then enter values or expressions in the field or matrix.



If another type of temperature dependence is used other than a linear temperature relation, enter any expression for the conductivity as a function of temperature.

Linearized Resistivity

Select **Linearized resistivity** for a temperature-dependent conductivity (this occurs in, for example, Joule heating, and is also called resistive heating). The equation describing the conductivity:

$$\sigma = \frac{1}{\rho_0(1 + \alpha(T - T_{\text{ref}}))}$$

where ρ_0 is the resistivity at the reference temperature T_0 , and α is the temperature coefficient of resistance, which describes how the resistivity varies with temperature.

The default **Reference temperature** T_{ref} (SI unit: K), **Resistivity temperature coefficient** α (SI unit: 1/K), and **Reference resistivity** ρ_0 (SI unit: $\Omega \cdot \text{m}$) are taken **From material**, which means that the values are taken from the domain material.



Only certain material models support the **Linearized resistivity**. See [AC/DC Materials Database](#) in the *COMSOL Multiphysics Reference Manual*.

To specify other values for any of these properties, select **User defined** from the list and then enter a value or expression. T is the current temperature, which can be a value that is specified as a model input or the temperature from a Heat Transfer interface. The definition of the temperature field appears in the **Model Inputs** section.

When **Effective medium** is selected, the [Effective Medium](#) subnode is available from the context menu (right-click the parent node) or from the **Physics** toolbar, **Attributes** menu. When **Archie's law** is selected, an [Archie's Law](#) subnode is available.

Initial Values

Initial Values adds an initial value for the electric potential that can serve as an initial condition for a transient simulation or as an initial guess for a nonlinear solver. Add more **Initial Values** nodes from the **Physics** toolbar.

INITIAL VALUES

Enter a value or expression for the initial value of the **Electric potential** V (SI unit: V). The default is 0 V.

Current Source

The **Current Source** node adds a distributed current source Q_j in the equation that the physics interface defines. Use this node with caution as it might violate the current conservation law that is inherent in Maxwell-Ampère's law.

Add a contribution as a **Harmonic Perturbation** by right-clicking the parent node or click **Harmonic Perturbation** on the **Physics** toolbar. For more information see [Harmonic Perturbation — Exclusive and Contributing Nodes](#) in the *COMSOL Multiphysics Reference Manual*.

ELECTRODE CURRENT SOURCE

Enter a value or expression for the **Current source** Q_j (SI unit: A/m³). The default is 0 A/m³.

Change Shell Thickness

Add a **Change Shell Thickness** node to specify a different shell thickness for a subset of the boundaries or edges where the **Electric Currents, Single Layer Shell** interface is defined.

CHANGE SHELL THICKNESS

Enter a **Shell thickness** d_s (SI unit: m). The default is 1 cm.

Normal Current Density

The **Normal Current Density** node represents a current density flowing normally from the domain into the shell boundary. This condition is different from the [Current Source](#) node since it represents a net current density flowing from the adjacent domain into the shell, and can be used to model, for example, a boundary acting as an electrode.

Add a contribution as a **Harmonic Perturbation** by right-clicking the parent node or click **Harmonic Perturbation** on the **Physics** toolbar. For more information see [Harmonic Perturbation — Exclusive and Contributing Nodes](#) in the *COMSOL Multiphysics Reference Manual*.

NORMAL CURRENT DENSITY

Enter a value or expression for the **Normal current density** J_n (SI unit: A/m²). The default is 0 A/m².

Electric Shielding

The **Electric Shielding** node, available for 3D components, can be used to model a geometrically thin section of shell made of a highly conductive medium. The layer thickness parameter d_1 specifies the thickness in the direction tangential to the shell, while the thickness in the direction normal to the shell is taken from the physics interface or, if present, from a [Change Shell Thickness](#) node.

The layer has an electrical conductivity of σ and a relative permittivity of ϵ_r .

ELECTRIC SHIELDING

The default **Relative permittivity** ϵ_r (dimensionless) and **Electrical conductivity** σ (SI unit: S/m) take values **From material**. For **User defined** enter different values or expressions.

Enter a value or expression for the **Layer thickness** d_1 (SI unit: m). The default is 1 cm.

The Electric Currents, Layered Shell Interface

The **Electric Currents, Layered Shell (ecls)** interface () is a legacy interface used to compute electric fields, currents, and potential distributions in thin conducting layered shells under conditions where inductive effects are negligible; that is, when the skin depth is much larger than the studied device. It supports stationary modeling on faces in 3D.



The model with this interface can still be opened and solved. The interface cannot be added as a new interface and it has been replaced by [The Electric Currents in Layered Shells Interface](#), which is found under the **Electric Fields and Currents** folder under the **AC/DC** branch ().

The physics interface solves a current conservation equation based on Ohm's law using the scalar electric potential as the dependent variable. The electric potential is added either by the [Layered Shell](#) feature or the [Homogenized Shell](#) feature. Both features have advantages and disadvantages, particularly considering shell thickness and electrical connections between the shells.

For (moderately) thick shells, the *layered shell* implementation is superior as it provides a full 3D representation (perpendicular potential gradients and -currents are included by means of an *extra dimension*). The *homogenized shell* implementation instead only solves for in-plane potential gradients. It requires less degrees of freedom, and is numerically more stable. It is especially useful for very thin layers, for which the layered shell implementation may fail. Moreover, it naturally preserves electrical continuity across edges interior to the shell. Both the **Layered Shell** feature and the **Homogenized Shell** feature are equipped with a number of subfeatures, allowing you to take advantage of the strength of each, in different parts of the model.

When the physics interface is added, the following default nodes are added to the **Model Builder**— **Layered Shell** and **Electric Insulation** (the default edge condition). Then, from the **Physics** toolbar, other nodes can be added that implement, for example, boundary

or edge conditions and interlayer connections. You can also right-click **Electric Currents**, **Layered Shell** to select physics features from the context menu.



- This interface supports the [Layered Shell](#) feature, which means each boundary may represent a number of thin layers with different electrical properties. Potential variations in the normal direction (in between and inside layers) are supported. For a general description of layer and interface selections, see [The Layer Selection Section](#). See also the section on how to set up a [Layered Material](#) node in the *COMSOL Multiphysics Reference Manual*.



For a more extensive introduction to the physics and equations implemented by this physics interface, see [The Electric Currents Interface](#), and the [Theory for the Electric Currents Interface](#). Additional information is available in [The Electric Currents, Single Layer Shell Interface](#) chapter.

SETTINGS

The **Label** is the default physics interface name.

The **Name** is used primarily as a scope prefix for variables defined by the physics interface. Refer to such physics interface variables in expressions using the pattern `<name>.<variable_name>`. In order to distinguish between variables belonging to different physics interfaces, the `name` string must be unique. Only letters, numbers and underscores (`_`) are permitted in the **Name** field. The first character must be a letter.

The default **Name** (for the first physics interface in the model) is `ec1s`.

LAYER SELECTION

Select the applicable layers (the default setting is **All layered materials**). If no layered materials have been included yet, there is a shorthand available for creating a **Single Layer Material** (the plus, next to the **Layer Selection** setting).



- For a general description of layer and interface selections, see [The Layer Selection Section](#).
- You can provide material parameters with a through-thickness variation by explicitly or implicitly using expressions containing the extra dimension coordinate as described in [Using the Extra Dimension Coordinates](#).

DEPENDENT VARIABLES

The dependent variable (field variable) is for the **Electric potential** V . The name can be changed but the names of fields and dependent variables must be unique within a model. This variable is explicitly used only by **Homogenized Shell** features. The **Layered Shell** features have their own variable name (for the degrees of freedom in the extra dimension).

DISCRETIZATION

The setting for the discretization order is shared by the **Homogenized Shell** degrees of freedom and the **Layered Shell** degrees of freedom.

The Layer Selection Section

Almost all physics nodes that you add in the Electric Currents, Layered Shell interface have a section named **Layer Selection**. Selections there interact with the standard selections of geometrical objects (boundaries and edges) in order to provide a complete specification of where a material property or boundary condition is to be applied.

The physics features can be of two, fundamentally different, types: Those which act on the layers themselves, and those which act on the interfaces between layers. The settings for these two types of features are slightly different.

The default selections in the **Layer Selection** section differ between different physics features. This reflects the fact that some physics features (such as the [Layered Shell](#) feature) are more likely to be applied to all layers, whereas other features (such as the

[Homogenized Shell Connection](#)) are more likely to be used for a single layer or interface.

In the **Layer** drop-down list, you can select

- **All layered materials.** This option is not available for all features.
- Any **Layered Material Link** defined under **Materials** in the current component.
- Any **Layered Material Stack** defined under **Materials** in the current component.
- Any **Single Layer Material** defined under **Materials** in the current component.

If you select **All layered materials**, you cannot control individual layers; the contribution is given to all layers. All information is taken from the definitions made in the layered material features (**Layered Material Link**, **Layered Material Stack**, or **Single Layer Material**) under **Materials** in the current component. This means that a single physics node can accommodate several different stacking sequences. As geometrical selection, you can use any object selected in any of the layered material features.

If you select an individual **Layered Material Link**, **Layered Material Stack**, or **Single Layer Material**, then you can only select geometrical objects which are part of the selections of that feature. In most cases, you will get access to a list of check boxes where you can further limit the contributions to individually selected layers or interfaces to which this contribution is to be added.

LAYER SELECTIONS

When a physics feature acts on layers, the interpretation of layer selections are:

- A boundary selection in the geometry corresponds to a domain contribution in the selected layers.
- An edge selection in the geometry corresponds to boundary contributions on the faces of the layers exposed to that edge.

This is illustrated by [Figure 4-6](#) and [Figure 4-7](#), where the patch at the lower left is the actual shell, and the 3D sketch shows an expanded view of what it would represent in the physical world.

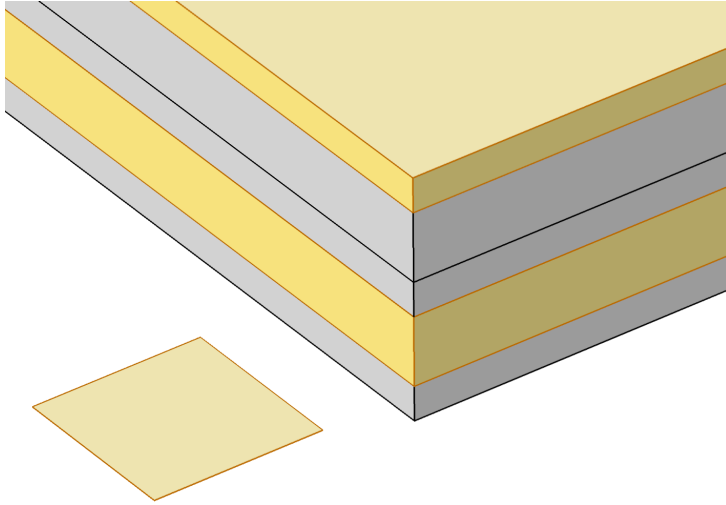

Figure 4-6: Boundary selection with layers 2 and 5 selected.

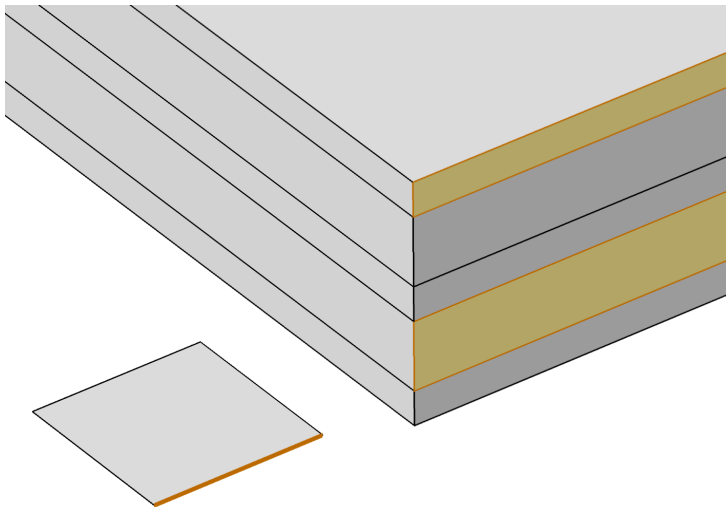

Figure 4-7: Edge selection with layers 2 and 5 selected.

INTERFACE SELECTIONS

When a physics feature acts on interfaces, the interpretation of interface selections are:

- A boundary selection in the geometry corresponds to boundary contributions on the selected interfaces.
- An edge selection in the geometry corresponds to edge contributions on the interface edges parallel to the selected edge.

This is illustrated by [Figure 4-8](#) and [Figure 4-9](#), where the patch at the lower left is the actual shell, and the 3D sketch shows an expanded view of what it would represent in the physical world.

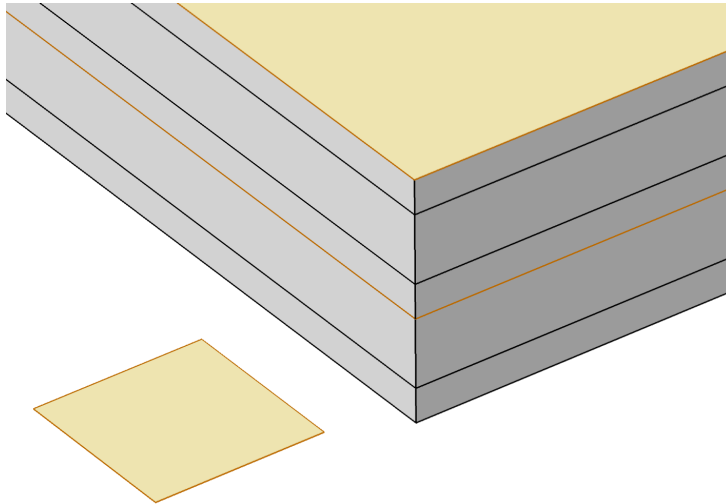

Figure 4-8: Boundary selection with interfaces 'layer 2 - layer 3' and 'layer 5 up' selected.

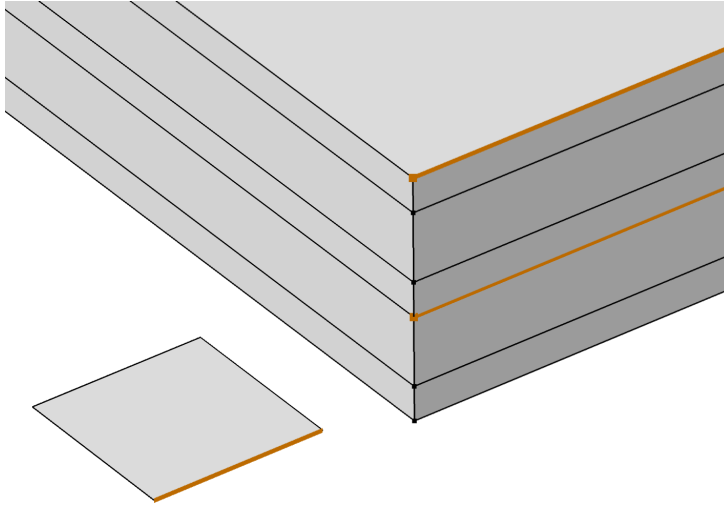

Figure 4-9: Edge selection with interfaces 'layer 2 - layer 3' and 'layer 5 up' selected.

Electrical Continuity in the Electric Currents, Layered Shell Interface

Electric potential in Electric Currents, Layered Shell Interface can be described either by the [Homogenized Shell](#), or [Layered Shell](#) feature.

- The **Homogenized Shell** feature imposes electrical continuity among all adjacent homogenized shells, regardless whether they belong to the same **Layered Material**.
- The **Layered Shell** feature exclusively imposes electrical continuity within layered shells sharing the same **Layered Material**.
- The **Layered Shell** feature and the **Homogenized Shell** feature are electrically insulated by default (even when sharing the same **Layered Material**). To override this insulation you can use the [Homogenized Shell Connection](#) feature.

For more information; these cases are demonstrated in the *Solid to Multilayered Shell Comparison* model available in the Application Library.

Using the Extra Dimension Coordinates

Sometimes, you want to write expressions that are functions of the coordinates in the thickness direction of the shell. If you write expressions based on the usual coordinates,

like x , y , and z , such an expression will be evaluated on the reference surface (the meshed boundaries). In addition to this, you can access locations in the through-thickness direction by making explicit or implicit use of the coordinates in the extra dimension.

The extra dimension coordinate has a name like `x_llmat1_xdim`. The middle part of the coordinate name is derived from the tag of the layered material definition where it is created; in this example a **Layered Material Link**.

Boundary and Edge Nodes for the Electric Currents, Layered Shell Interface

The **Electric Currents, Layered Shell Interface** has these boundary and edge nodes available from the **Physics** ribbon toolbar (Windows users), **Physics** context menu (Mac or Linux users), or right-click to access the context menu (all users).



In general, to add a node, go to the **Physics** toolbar, no matter what operating system you are using. Subnodes are available by clicking the parent node and selecting it from the **Attributes** menu.

ABOUT THE EDGE CONDITION SELECTIONS

The edge conditions available in the Electric Currents, Layered Shell Interface are applicable to exterior edges only. For shell interfaces, *exterior* means exterior to the boundary selection. In other words; an edge that is connected to adjacent boundaries, only on one side. Consequently, an edge can be regarded as interior (and therefore, not applicable), even though it is *exterior* to the domain that is enclosed by the shell boundary selection.

AVAILABLE NODES

These nodes and subnodes are described in this section:

- [Layered Shell](#)
- [Interlayer Connection](#)
- [Homogenized Shell Connection](#)
- [Homogenized Shell](#)
- [Varying Thickness](#)
- [Layer Current Source](#)
- [Interface Current Source](#)

These nodes are available for this physics interface and described for the Electric Currents and Electrostatics interfaces (listed in alphabetical order):

- [Electric Insulation](#)
- [Electric Potential](#)
- [External Current Density](#)
- [Ground](#)
- [Terminal](#)

Layered Shell

The **Layered Shell** node adds the continuity equation for the electric potential and allows for defining the electric conductivity of the layers. This interface closely relates to **Current Conservation** under [The Electric Currents Interface](#). Even though the interface works on the boundary level, the resulting equations correspond directly to a volumetric model. The **Layered Shell** includes an extra dimension to describe perpendicular gradients.

Notice that the **Layered Shell** requires a **Layered Material**. This has consequences for the continuity equation. For more information about continuity handling, see [Electrical Continuity in the Electric Currents, Layered Shell Interface](#).

LAYER SELECTION

Select the applicable layers (the default setting is **All layered materials**). Additionally, there is a shorthand available for creating a **Single Layer Material** (the plus, next to the **Layer Selection** setting).



- For a general description of layer and interface selections, see [The Layer Selection Section](#).
- The default **Layered Shell** feature will be locked to the physics interface selection. You can add additional **Layered Shell** features for specific layers, overriding the default properties.
- You can provide material parameters with a through-thickness variation by explicitly or implicitly using expressions containing the extra dimension coordinate as described in [Using the Extra Dimension Coordinates](#).

CONDUCTION CURRENT

By default, the **Electrical conductivity** σ (SI unit: S/m) of the layers is defined as **From material**. If you select **User defined**, the same user defined value will be applied to all selected layers.



Note that, as opposed to the [Current Conservation](#) feature in the Electric Currents, Single Layer Shell Interface, and the [Homogenized Shell](#) feature in the Electric Currents, Layered Shell Interface, the Layered Shell feature does support general anisotropy.

User Defined

For **User defined** select **Isotropic**, **Diagonal**, **Symmetric**, or **Full** depending on the characteristics of the electrical conductivity, and then enter values or expressions in the field or matrix.

Interlayer Connection

The **Interlayer Connection** is available both for boundaries, and edges. In both cases it removes for the selected layers, the potential gradient in the perpendicular direction (in the direction of the *extra dimension*). The layers will become electrically connected, and the top and bottom of all involved layers will have the same potential. Multiple **Interlayer Connection** features can be applied to create groups of connected layers.

An **Interlayer Connection** on a single layer can be used to locally convert the full 3D formulation into an in-plane conservation problem. For thin highly conductive layers, this is numerically more stable.

LAYER SELECTION

Select the applicable layers. The layered material is given by the **Layered Shell** parent feature.



- For a general description of layer and interface selections, see [The Layer Selection Section](#).

CONSTRAINT SETTINGS

To display this section, click the **Show More Options** button () and select **Advanced Physics Options**.

Homogenized Shell Connection

The **Homogenized Shell Connection** is available for edges. It can be used to override the natural default electric insulation between **Layered Shell** and **Homogenized Shell** features. For more information about continuity of electric potential in Electric Currents, Layered Shell interface, go to [Electrical Continuity in the Electric Currents, Layered Shell Interface](#).

The **Homogenized Shell Connection** removes for the selected layers, the potential gradient in the direction normal to the shell (in the direction of the *extra dimension*), by setting the potential equal to the one in the *base selection*. The base selection potential is the one used by the [Homogenized Shell](#) feature. Setting the potential equal to the base potential creates an electrical connection between the selected layers, and **Homogenized Shell** boundaries adjacent to the selected edge.

LAYER SELECTION

Select the applicable layers. The layered material is given by the **Layered Shell** parent feature.



- For a general description of layer and interface selections, see [The Layer Selection Section](#).
-

CONSTRAINT SETTINGS

To display this section, click the **Show More Options** button () and select **Advanced Physics Options**.

Homogenized Shell

The **Homogenized Shell** feature takes the material properties from one or more selected layers, and determines their effective material properties. It integrates the conductivity in the direction normal to the shell (in the direction of the *extra dimension*), taking the local layer thickness into account:

$$\sigma_{\text{eff}} = \frac{1}{d} \int_{\text{XD}} \sigma dx,$$

where d refers to the total thickness of all layers involved. For a discrete set of layers having their own uniform material properties, this integral effectively translates to a sum of conductivities, multiplied by their corresponding local layer thickness:

$$\sigma_{\text{eff}} = \frac{1}{d} \sum_{i=1}^n d_{1,i} \sigma_i.$$

This represents a parallel connection of resistors. The **Varying Thickness** subfeature can be used to locally affect the degree to which a particular layer contributes to the sum.



- If composite, layered materials and general anisotropy are not of interest to you and you want to solve an in-shell current conservation problem (as with [The Electric Currents, Single Layer Shell Interface](#)), use a **Homogenized Shell** feature with a **Single Layer Material**.
- The **Varying Thickness** subfeature will allow you to set a spatially or temporally varying thickness (to model material deposition and such).
- The electric potential is automatically continuous among adjacent **Homogenized Shells**. More information about continuity in Electric Currents, Layered Shell interface can be found in the chapter [Electrical Continuity in the Electric Currents, Layered Shell Interface](#).

The resulting material properties are then used in a current conservation problem, that only considers the potential gradients tangential to the shell (in-plane conservation law):

$$\nabla_{\text{T}} \cdot (d\sigma_{\text{eff}} \mathbf{E}_{\text{T}}) = \nabla_{\text{T}} \cdot \mathbf{J}_{\text{s}} = \int_{\text{XD}} Q_{\text{s}} dx,$$

where the product $d\sigma_{\text{eff}} \mathbf{E}_{\text{T}}$ is effectively the surface current density \mathbf{J}_{s} in A/m. \mathbf{E}_{T} is the tangential electric field, and Q_{s} represents a volumetric source of current. Without sources, the right-hand side becomes zero, and in-plane current should be conserved.

When applied to a single layer, the **Homogenized Shell** is virtually identical to the traditional, nonlayered [Current Conservation](#) feature in the Electric Currents, Single Layer Shell Interface.

LAYER SELECTION

Select the layers to be included in the integral for the effective material properties.



- For a general description of layer and interface selections, see [The Layer Selection Section](#).

CONDUCTION CURRENT

By default, the **Electrical conductivity** σ (SI unit: S/m) of the layers is defined as **From material**. If you select **User defined**, the same user defined value will be applied to all selected layers.

Varying Thickness

The **Varying Thickness** feature is a subfeature to the **Homogenized Shell** feature. It allows to set a spatially or temporally varying thickness. This is typically used for modeling material deposition and such. For more information on varying thickness and the homogenized shell, see the [Homogenized Shell](#) feature.

LAYER SELECTION

Select the layers for which the thickness should be varied.



- For a general description of layer and interface selections, see [The Layer Selection Section](#).
-

VARYING THICKNESS

Enter a value or expression for the **Selected layers thickness** d_1 (SI unit: m). May depend on location, time, temperature, or other quantities. The default value is 0.1 mm.

Layer Current Source

The **Layer Current Source** is available both for boundaries, and edges. In case of a boundary, it represents a volumetric source of current $Q_{j,v}$ inside the selected layers (SI unit: A/m³).

In case of an edge, it represents an influx of current $Q_{j,s}$ from the edge into the neighboring layers (SI unit: A/m²). In the 3D representation of the layer stack, you could consider it a “boundary current source” applied to one of the boundaries on the outer perimeter of the layer. For more information on the 3D representation of the layer stack, see [The Layer Selection Section](#).



Use this node with caution as it might violate the current conservation law that is inherent in Maxwell-Ampère’s law.

LAYER SELECTION

Select the layers for which the source contribution should be added.



- For a general description of layer and interface selections, see [The Layer Selection Section](#).

LAYER CURRENT SOURCE

Enter a value or expression for the **Current source** $Q_{j,v}$ or $Q_{j,s}$ (SI unit: A/m^3 or A/m^2 , respectively). For the boundary feature, the default is $0 A/m^3$, for an edge feature, the default is $0 A/m^2$.

Interface Current Source

The **Interface Current Source** is available for boundaries only. It is similar to the [Layer Current Source](#), but instead of representing a source interior to the layer, or a source on the layer's outer perimeter, it represents a net current density flowing from the adjacent domain into the shell ($Q_{j,s}$, SI unit: A/m^2). It can be used to model, for example, a boundary acting as an electrode. Alternatively, for interior interface selections it may represent a source of current on an interface in-between layers.

In the 3D representation of the layer stack, you could consider it a “boundary current source” applied to either the top or bottom of the layer stack, or on an interface in-between layers. For more information on the 3D representation of the layer stack, see [The Layer Selection Section](#).



Use this node with caution as it might violate the current conservation law that is inherent in Maxwell-Ampère's law.

INTERFACE SELECTION

Select the interfaces for which the source contribution should be added.



- For a general description of layer and interface selections, see [The Layer Selection Section](#).

INTERFACE CURRENT SOURCE

Enter a value or expression for the **Current source** $Q_{j,s}$ (SI unit: A/m²). The default is 0 A/m².

Electric Currents Solid to Shell Via Boundary

The **Electric Currents Solid to Shell Via Boundary** multiphysics coupling assures continuity of the electric potential between [The Electric Currents, Layered Shell Interface](#) and [The Electric Currents Interface](#). The **Electric Currents Solid to Shell Via Boundary** node is available from the **Multiphysics** menu in the **Physics** toolbar or by right-clicking the **Multiphysics Couplings** node in **Model Builder**, if both [The Electric Currents, Layered Shell Interface](#) and [The Electric Currents Interface](#) are available.

Theory for the Electrostatics Interface

The [Electrostatics Interface](#) is available for 3D, 2D in-plane, and 2D axisymmetric components. Applications with electrostatic equations include high-voltage apparatus, electronic devices, and capacitors. The term “statics” is not to be interpreted literally — it is the observation time, or time scale at which the applied excitation changes, that is short compared to the charge relaxation time; also, the electromagnetic wavelength and skin depth are very large compared to the size of the domain of interest.

If you do not know whether to use the Electric Currents or the Electrostatics interface, which both solve for the scalar electric potential V , consider using an explicit charge transport model. See [Charge Relaxation Theory](#).

In this section:

- [Electrostatics Equations](#)
- [The Electrostatics Interface in Time Dependent or Frequency Domain Studies](#).
- [Effective Material Properties in Effective Media and Mixtures](#)
- [Effective Conductivity in Effective Media and Mixtures](#)
- [Effective Relative Permittivity in Effective Media and Mixtures](#)
- [Effective Relative Permeability in Effective Media and Mixtures](#)
- [Archie’s Law Theory](#)



For a discussion about the boundary element method used with [The Electrostatics, Boundary Elements Interface](#), see [Theory for the Boundary Elements PDE](#) in the *COMSOL Multiphysics Reference Manual*.

Charge Relaxation Theory

COMSOL Multiphysics includes physics interfaces for the modeling of static electric fields and currents. Deciding what specific physics interface and study type to select for a particular modeling situation requires a basic understanding of the charge dynamics in conductors.

The different physics interfaces involving only the scalar electric potential can be interpreted in terms of the charge relaxation process. The fundamental equations involved are *Ohm's law* for the conduction current density

$$\mathbf{J}_c = \sigma \mathbf{E}$$

the *equation of continuity*

$$\frac{\partial \rho}{\partial t} + \nabla \cdot \mathbf{J}_c = 0$$

and *Gauss' law*

$$\nabla \cdot (\epsilon \mathbf{E}) = \rho$$

By combining these, one can deduce the following differential equation for the space charge density in a homogeneous medium

$$\frac{\partial \rho}{\partial t} + \frac{\sigma}{\epsilon} \rho = 0$$

This equation has the solution

$$\rho(t) = \rho_0 e^{-t/\tau}$$

where

$$\tau = \frac{\epsilon}{\sigma}$$

is called the charge relaxation time. For a good conductor like copper, τ is of the order of 10^{-19} s, whereas for a good insulator like silica glass, it is of the order of 10^3 s. For a pure insulator, it becomes infinite.

When modeling real-world devices, there is not only the *intrinsic time scale* of the charge relaxation time but also an *external time scale* t at which a device is energized or the observation time. It is the relation between the external time scale and the charge relaxation time that determines what physics interface and study type to use. The results are summarized in [Table 4-3](#) below,

TABLE 4-3: SUITABLE PHYSICS INTERFACE AND STUDY TYPE FOR DIFFERENT TIME-SCALE REGIMES.

CASE	PHYSICS INTERFACE	STUDY TYPE
$\tau \gg t$	Electrostatics	Stationary

TABLE 4-3: SUITABLE PHYSICS INTERFACE AND STUDY TYPE FOR DIFFERENT TIME-SCALE REGIMES.

CASE	PHYSICS INTERFACE	STUDY TYPE
$\tau \ll t$	Electric Currents	Stationary
$\tau \sim t$	Electric Currents	Time Dependent or Frequency Domain

FIRST CASE: $\tau \gg T$

If the external time scale is short compared to the charge relaxation time, the charges do not have time to redistribute to any significant degree. Thus the charge distribution can be considered as a given model input. The best approach is to solve the Electrostatics formulation using the electric potential V .

By combining the definition of the potential with Gauss' law, you can derive the classical Poisson's equation. Under static conditions, the electric potential V is defined by the equivalence $\mathbf{E} = -\nabla V$. Using this together with the constitutive relation $\mathbf{D} = \epsilon_0 \mathbf{E} + \mathbf{P}$ between \mathbf{D} and \mathbf{E} , you can rewrite Gauss' law as a variant of Poisson's equation

$$-\nabla \cdot (\epsilon_0 \nabla V - \mathbf{P}) = \rho$$

This equation is used in the Electrostatics interface. It is worth noting that Gauss' law does not require the charge distribution to be static. Thus, provided dynamics are slow enough that induced electric fields can be neglected and hence a scalar electric potential is justified, the formulation can be used also in the Time Dependent study type. That typically involves either prescribing the charge dynamics or coupling a separate formulation for this.



Such separate charge transport formulations can be found in the Plasma Module, the Semiconductor Module, and the Chemical Reaction Engineering Module.

SECOND CASE: $\tau \ll T$

If the external time scale is long compared to the charge relaxation time, the stationary solution to the equation of continuity has been reached. In a stationary coordinate system, a slightly more general form of Ohm's law than above states that

$$\mathbf{J}_c = \sigma \mathbf{E} + \mathbf{J}_e$$

where \mathbf{J}_e is an externally generated current density. The static form of the equation of continuity then reads

$$\nabla \cdot \mathbf{J}_c = -\nabla \cdot (\sigma \nabla V - \mathbf{J}_e) = 0$$

To handle current sources, the equation can be generalized to

$$-\nabla \cdot (\sigma \nabla V - \mathbf{J}_e) = Q_j$$

This equation is used in the static study type for the Electric Currents interface.

GENERAL CASE: CHARGE DYNAMICS

If the charge relaxation time is comparable to the external time scale, the Time Dependent or Frequency Domain study types for the Electric Currents interface must be used.

Combining the time-harmonic equation of continuity

$$\nabla \cdot \mathbf{J}_c = \nabla \cdot (\sigma \mathbf{E} + \mathbf{J}_e) = -j\omega\rho$$

with the equation ($\nabla \cdot \mathbf{D} = \rho$) yields the following equation for the frequency domain study type:

$$-\nabla \cdot ((\sigma + j\omega\epsilon_0)\nabla V - (\mathbf{J}_e + j\omega\mathbf{P})) = 0$$

For the Time Dependent study type, use the transient equation of continuity

$$\nabla \cdot \mathbf{J}_c = \nabla \cdot (\sigma \mathbf{E} + \mathbf{J}_e) = \frac{\partial \rho}{\partial t}$$

and the resulting equation becomes

$$-\nabla \cdot \frac{\partial}{\partial t}(\epsilon_0 \nabla V + \mathbf{P}) - \nabla \cdot (\sigma \nabla V - \mathbf{J}_e) = 0$$

These dynamic formulations are valid as long as induced electric fields can be ignored and hence the electric field is essentially curl free. This condition is fulfilled provided that skin effect and wave propagation effects can be ignored. The skin depth must be much larger than the geometrical dimensions of the modeled device and so must the wavelength. Note also that these formulations can be used to model dielectric regions of capacitive/resistive devices even though the interior of electrodes sometimes does not meet the large skin depth condition. In that case, the electrodes must only be represented as boundary conditions (fixed or floating potential). The interior, metallic domains are not included in the analysis. Obviously, this is only a valid approach for devices where metallic electrodes do not entirely bypass (short circuit) the capacitive/resistive layers. If metallic electrodes short circuit the capacitive/resistive layers, the time evolution of the current is determined by inductive and resistive effects

with very little influence from the capacitive layers. Then the Magnetic Fields interface is the appropriate modeling tool.

Electrostatics Equations

Under static conditions, the electric potential, V , is defined by the relationship:

$$\mathbf{E} = -\nabla V$$

Combining this equation with the constitutive relationship $\mathbf{D} = \epsilon_0 \mathbf{E} + \mathbf{P}$ between the electric displacement \mathbf{D} and the electric field \mathbf{E} , it is possible to represent Gauss' law as the following equation:

$$-\nabla \cdot (\epsilon_0 \nabla V - \mathbf{P}) = \rho$$

In this equation, the physical constant, ϵ_0 (SI unit: F/m) is the permittivity of vacuum, \mathbf{P} (SI unit: C/m²) is the electric polarization vector, and ρ (SI unit: C/m³) is a space charge density. This equation describes the electrostatic field in dielectric materials.

For in-plane 2D modeling, the Electrostatics interface assumes a symmetry where the electric potential varies only in the x and y directions and is constant in the z direction. This implies that the electric field, \mathbf{E} , is tangential to the xy -plane. With this symmetry, the same equation is solved as in the 3D case. The physics interface solves the following equation where d is the thickness in the z direction:

$$-\nabla \cdot d(\epsilon_0 \nabla V - \mathbf{P}) = \rho$$

The axisymmetric version of the physics interface considers the situation where the fields and geometry are axially symmetric. In this case, the electric potential is constant in the φ direction, which implies that the electric field is tangential to the rz -plane.

The Electrostatics Interface in Time Dependent or Frequency Domain Studies

[The Electrostatics Interface](#) can also be solved in a dynamic study (Time Dependent or Frequency Domain). The equation system solved, however, is typically always the one presented in the previous section for the stationary case, in which no transient electromagnetic effects are taken into account. The difference is that the sources of the

problem (charge densities, electric potential) are assumed to be time-varying (in a Time Dependent study) or time-harmonic (in a Frequency Domain study).



Users that have a license supporting the piezoelectric material model can also include conduction losses in the frequency domain.

The support for dynamic studies simplifies the coupling of the Electrostatics interface with other physics interfaces. Using the physics interface in a dynamic study is a valid approximation only if the time-scale (or the frequency) of the study is so slow that transient electromagnetic effects can be neglected; for example, in acoustic or structural problems.

Most of the features in the Electrostatics interface have the same behavior in all study types, with the important exception of the Terminal node.

The Electrostatics interface also supports the small-signal analysis study sequence, which can be used when a time-harmonic perturbation is superposed on a static bias charge or voltage.

Effective Material Properties in Effective Media and Mixtures

One way of dealing with effective media or mixtures of solids in electromagnetic models is to replace them with an homogenized medium. The electric and magnetic properties of this medium are computed from the properties of each phase by means of an averaging formula.

There are several possible approaches to compute an average material property starting from the material properties and the volume fraction of each material.

The following sections illustrate the different formulas available to compute the *effective electrical conductivity*, the *effective relative permittivity* and the *effective relative permeability* of a homogenized medium. In the following, volume fractions of the materials are indicated with θ_i , where i is the material index, and they are assumed to be fractional (between 0 and 1). Up to five different materials can be specified as phases of the mixture. Typically, their volume fractions should add up to 1.

Effective Conductivity in Effective Media and Mixtures

Three methods are available to compute the averaged electrical conductivity of the mixture.

VOLUME AVERAGE, CONDUCTIVITY

If the electric conductivities of the two materials are not so different from each other, a simple form of averaging can be used, such as a volume average:

$$\sigma = \sum_{i=1}^n \theta_i \sigma_i = \theta_1 \sigma_1 + \theta_2 \sigma_2 + \dots$$

where σ_i is the conductivity of the material i . This is equivalent to a “parallel” system of resistivities.

If the conductivities are defined by second order tensors (such as for anisotropic materials), the volume average is applied element by element.

VOLUME AVERAGE, RESISTIVITY

A similar expression for the effective conductivity can be used, which mimics a “series” connection of resistivities. Equivalently, the effective conductivity is obtained from

$$\frac{1}{\sigma} = \sum_{i=0}^n \frac{\theta_i}{\sigma_i} = \frac{\theta_1}{\sigma_1} + \frac{\theta_2}{\sigma_2} + \dots$$

If the conductivities are defined by second order tensors, the inverse of the tensors are used.

POWER LAW

A power law gives the following expression for the equivalent conductivity:

$$\sigma = \prod_{i=0}^n \sigma_i^{\theta_i} = \sigma_1^{\theta_1} \sigma_2^{\theta_2} \dots$$

The effective conductivity calculated by [Volume Average, Conductivity](#) is the upper bound, the effective conductivity calculated by [Volume Average, Resistivity](#) is the lower bound, and the [Power Law](#) average is somewhere in between these two.

Effective Relative Permittivity in Effective Media and Mixtures

Three methods are available to compute the averaged electrical conductivity of the mixture.

VOLUME AVERAGE, PERMITTIVITY

If the relative permittivity of the two materials is not so different from each other, the effective relative permittivity ϵ_r is calculated by simple volume average:

$$\epsilon = \sum_{i=1}^n \theta_i \epsilon_i = \theta_1 \epsilon_1 + \theta_2 \epsilon_2 + \dots$$

where ϵ_i is the relative permeability of the material i .

If the permittivity is defined by second-order tensors (such as for anisotropic materials), the volume average is applied element by element.

VOLUME AVERAGE, RECIPROCAL PERMITTIVITY

The second method is the volume average of the inverse of the permittivities:

$$\frac{1}{\epsilon} = \sum_{i=0}^n \frac{\theta_i}{\epsilon_i} = \frac{\theta_1}{\epsilon_1} + \frac{\theta_2}{\epsilon_2} + \dots$$

If the permittivity is defined by a second-order tensor, the inverse of the tensor is used.

POWER LAW

A power law gives the following expression for the equivalent permittivity:

$$\epsilon = \prod_{i=0}^n \epsilon_i^{\theta_i} = \epsilon_1^{\theta_1} \epsilon_2^{\theta_2} \dots$$

The effective permeability calculated by [Volume Average, Permittivity](#) is the upper bound, the effective permeability calculated by [Volume Average, Reciprocal Permittivity](#) is the lower bound, and the [Power Law](#) average gives a value somewhere in between these two.

Effective Relative Permeability in Effective Media and Mixtures

Three methods are available to compute the averaged electrical conductivity of the mixture.

VOLUME AVERAGE, PERMEABILITY

If the relative permeability of the two materials is not so different from each other, the effective relative permeability μ_r is calculated by simple volume average:

$$\mu = \sum_{i=1}^n \theta_i \mu_i = \theta_1 \mu_1 + \theta_2 \mu_2 + \dots$$

where μ_i is the relative permeability of the material i .

If the permeability is defined by second-order tensors (such as for anisotropic materials), the volume average is applied element by element.

VOLUME AVERAGE, RECIPROCAL PERMEABILITY

The second method is the volume average of the inverse of the permeabilities:

$$\frac{1}{\mu} = \sum_{i=0}^n \frac{\theta_i}{\mu_i} = \frac{\theta_1}{\mu_1} + \frac{\theta_2}{\mu_2} + \dots$$

If the permeability is defined by a second-order tensor, the inverse of the tensor is used.

POWER LAW

A power law gives the following expression for the equivalent permeability:

$$\mu = \prod_{i=0}^n \mu_i^{\theta_i} = \mu_1^{\theta_1} \mu_2^{\theta_2} \dots$$

The effective permeability calculated by [Volume Average, Permeability](#) is the upper bound, the effective permeability calculated by [Volume Average, Reciprocal Permeability](#) is the lower bound, and the [Power Law](#) average gives a value somewhere in between these two.

Archie's Law Theory

The electrical conductivity of the materials composing saturated rocks and soils can vary over many orders of magnitude. For instance, in the petroleum reservoirs, normal sea water (or brine) has a typical conductivity of around 3 S/m, whereas hydrocarbons are typically much more resistive and have conductivities in the range 0.1–0.01 S/m.

The porous rocks and sediments can have even lower conductivities. In variably saturated soils, the conductivity of air is roughly ten orders of magnitude lower than the ground water. A simple volume average (of either conductivity or resistivity) in rocks or soils might give different results compared to experimental data.

Since most crustal rocks, sedimentary rocks, and soils are formed by nonconducting materials, Archie (Ref. 1) assumed that electric current are mainly caused by ion fluxes through the pore network. Originally, Archie's law is an empirical law for the effective conductivity of a fully saturated rock or soil, but it can be extended to variably saturated porous media.

Archie's law relates the effective conductivity to the fluid conductivity σ_L , fluid saturation s_L , and porosity ϵ_p :

$$\sigma = s_L^n \epsilon_p^m \sigma_L$$

here, m is the cementation exponent, a parameter that describes the connectivity of the pores. The cementation exponent normally varies between 1.3 and 2.5 for most sedimentary rocks and is close to 2 for sandstones. The lower limit $m = 1$ represents a volume average of the conductivities of a fully saturated, insulating (zero conductivity) porous matrix, and a conducting fluid. The saturation coefficient n is normally close to 2. The ratio $F = \sigma_L/\sigma$ is called the *formation factor*.

Archie's law does not take care of the relative permittivity of either fluids or solids, so the effective relative permittivity of the porous medium is normally consider as $\epsilon_r = 1$.

Reference for Archie's Law

1. G.E. Archie, "The Electric Resistivity as an Aid in Determining Some Reservoir Characteristics," *Trans. Am. Inst. Metal. Eng.*, vol. 146, pp. 54–62, 1942.

Theory for the Electric Currents Interface

The [Electric Currents Interface](#) solves a current conservation problem for the scalar electric potential V and is available for 3D, 2D in-plane, and 2D axisymmetric components. Electrolysis and the computation of resistances of grounding plates are examples that involve conductive media with electrical conductivities and electric currents. If you are uncertain of whether to use the Electric Currents or the Electrostatics interface, which both solve for the scalar electric potential V , refer to the section on [Charge Relaxation Theory](#).

In this section:

- [Electric Currents Equations in Steady State](#)
- [Dynamic Electric Currents Equations](#)
- [Theory for Electrical Contact](#)

Electric Currents Equations in Steady State

When handling stationary electric currents in conductive media you must consider the stationary equation of continuity. In a stationary coordinate system, the point form of *Ohm's law* states that:

$$\mathbf{J} = \sigma \mathbf{E} + \mathbf{J}_e$$

where σ is the electrical conductivity (SI unit: S/m), and \mathbf{J}_e is an externally generated current density (SI unit: A/m²). The static form of the equation of continuity then states:

$$\nabla \cdot \mathbf{J} = -\nabla \cdot (\sigma \nabla V - \mathbf{J}_e) = 0$$

To handle current sources, you can generalize the equation to:

$$-\nabla \cdot (\sigma \nabla V - \mathbf{J}_e) = Q_j$$

In planar 2D the Electric Currents interface assumes that the model has a symmetry where the electric potential varies only in the x and y directions and is constant in the z direction. This implies that the electric field, \mathbf{E} , is tangential to the xy -plane. The

Electric Currents interface then solves the following equation, where d is the thickness in the z direction:

$$-\nabla \cdot d(\sigma \nabla V - \mathbf{J}_e) = dQ_j \quad (4-1)$$

In 2D axisymmetry, the Electric Currents interface considers the situation where the fields and geometry are axially symmetric. In this case, the electric potential is constant in the φ direction, which implies that the electric field is tangential to the rz -plane.

Dynamic Electric Currents Equations

In the Frequency Domain and Time Dependent study types dynamic formulations accounting for both conduction currents and displacement currents are used.

Combining the time-harmonic equation of continuity

$$\nabla \cdot (\sigma \mathbf{E} + \mathbf{J}_e) + j\omega\rho = 0$$

with the equation

$$\nabla \cdot \mathbf{D} = \rho$$

and generalized to handle current sources yields the following equation:

$$-\nabla \cdot ((\sigma + j\omega\epsilon_0)\nabla V - (\mathbf{J}_e + j\omega\mathbf{P})) = Q_j$$

For the transient case, using the transient equation of continuity

$$\nabla \cdot (\sigma \mathbf{E} + \mathbf{J}_e) + \frac{\partial \rho}{\partial t} = 0$$

and generalized to handle current sources the resulting equation becomes:

$$-\nabla \cdot \frac{\partial}{\partial t}(\epsilon_0 \nabla V - \mathbf{P}) - \nabla \cdot (\sigma \nabla V - \mathbf{J}_e) = Q_j \quad (4-2)$$

In planar 2D the dynamic formulations also involves the thickness d in the z direction:

$$\begin{aligned} -\nabla \cdot d((\sigma + j\omega\epsilon_0)\nabla V - (\mathbf{J}_e + j\omega\mathbf{P})) &= dQ_j \\ -\nabla \cdot d\frac{\partial}{\partial t}((\epsilon_0 \nabla V - \mathbf{P}) - \nabla \cdot d(\sigma \nabla V - \mathbf{J}_e)) &= dQ_j \end{aligned}$$

The **Electrical Contact** feature node has correlations to evaluate the joint conductance at two contacting surfaces.

The current densities at the upside and downside boundaries depend on the potential difference according to the relations:

$$\mathbf{n} \cdot \mathbf{J}_1 = -h_c(V_1 - V_2)$$

$$\mathbf{n} \cdot \mathbf{J}_2 = -h_c(V_2 - V_1)$$

At a microscopic level, contact is made at a finite number of spots as in **Figure 4-10**.

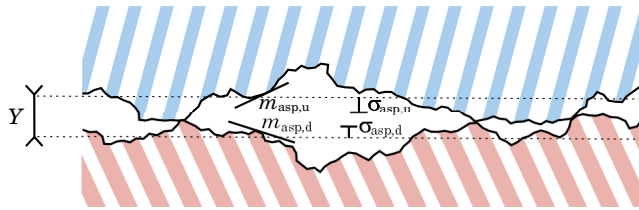

Figure 4-10: Contacting surfaces at the microscopic level.

SURFACE ASPERITIES

The microscopic surface asperities are characterized by the average height $\sigma_{u, asp}$ and $\sigma_{d, asp}$ and the average slope $m_{u, asp}$ and $m_{d, asp}$. The RMS values σ_{asp} and m_{asp} are (4.16 in Ref. 1):

$$\sigma_{asp} = \sqrt{\sigma_{u, asp}^2 + \sigma_{d, asp}^2} \quad m_{asp} = \sqrt{m_{u, asp}^2 + m_{d, asp}^2}$$

CONstriction CONDUCTANCE

Cooper-Mikic-Yovanovich (CMY) Correlation

The Cooper-Mikic-Yovanovich (CMY) correlation is valid for isotropic rough surfaces and has been formulated using a model assuming plastic deformation of the surface asperities. However, this model does not compute nor store the plastic deformations of the asperities. It means that, despite that a plastic deformation of the asperities is assumed, this contact model has no memory. For example, if a load is applied twice the electrical contact is identical in both cases. The Cooper-Mikic-Yovanovich (CMY) correlation relates h_c to the asperities and pressure load at the contact interface:

$$h_c = 1.25\sigma_{\text{contact}} \frac{m_{\text{asp}}}{\sigma_{\text{asp}}} \left(\frac{p}{H_c} \right)^{0.95}$$

Here, H_c is the microhardness of the softer material, p is the contact pressure, and σ_{contact} is the harmonic mean of the contacting surface conductivities:

$$\sigma_{\text{contact}} = \frac{2\sigma_u\sigma_d}{\sigma_u + \sigma_d}$$



When σ_u (resp. σ_d) is not isotropic, it is replaced by its normal conductivity $\mathbf{n}^T \sigma_u \mathbf{n}$ (resp. $\mathbf{n}^T \sigma_d \mathbf{n}$).

The relative pressure p/H_c can be evaluated by specifying H_c directly or using the following relation (4.16.1 in Ref. 1) for the relative pressure using c_1 and c_2 , the Vickers correlation coefficient and size index:

$$\frac{p}{H_c} = \left(\frac{p}{c_1 \left(1.62 \frac{\sigma_{\text{asp}}}{\sigma_0} m_{\text{asp}} \right)^{c_2}} \right)^{\frac{1}{(1 + 0.071c_2)}}$$

The coefficients c_1 and c_2 are the Vickers correlation coefficient and size index, respectively, and σ_0 is equal to 1 μm . For materials with Brinell hardness between 1.30 and 7.60 GPa, c_1 and c_2 are given by the correlation below (4.16.1 in Ref. 1):

$$\frac{c_1}{H_0} = 4.0 - 5.77 \frac{H_B}{H_0} + 4.0 \left(\frac{H_B}{H_0} \right)^2 - 0.61 \left(\frac{H_B}{H_0} \right)^3$$

$$c_2 = -0.37 + 0.442 \frac{H_B}{c_1}$$

The Brinell hardness is denoted by H_B , and H_0 is equal to 3.178 GPa.

Mikic Elastic Correlation

The Mikic correlation is valid for isotropic rough surfaces and assumes elastic deformations of surface asperities. It gives h_c by the following relation:

$$h_c = 1.54\sigma_{\text{contact}} \frac{m_{\text{asp}}}{\sigma_{\text{asp}}} \left(\frac{\sqrt{2}p}{mE_{\text{contact}}} \right)^{0.94}$$

Here, E_{contact} is an effective Young's modulus for the contact interface, satisfying (4.16.3 in Ref. 1):

$$\frac{1}{E_{\text{contact}}} = \frac{1 - \nu_u^2}{E_u} + \frac{1 - \nu_d^2}{E_d}$$

where E_u and E_d are the Young's moduli of the two contacting surfaces and ν_u and ν_d are the Poisson's ratios.



Electrical Contact

REFERENCE

1. M.M. Yovanovich and E.E. Marotta, "Thermal Spreading and Contact Resistance," *Heat Transfer Handbook*, A. Bejan and A.D. Kraus, John Wiley & Sons, 2003.

Theory for the Electric Currents, Single Layer Shell Interface

The [Electric Currents, Single Layer Shell Interface](#) in 3D to model thin shells of conductive media. This physics interface is similar to the 2D Electric Currents interface, solving for the electric potential on 2D surfaces in a 3D geometry. The difference is that the shell does not have to be flat as they obviously are when using the 2D Electric Currents interface. The Electric Currents, Single Layer Shell interface is also available on boundaries in 2D geometries.

In this section:

- [Electric Currents, Single Layer Shell Equations in Steady State](#)
- [Dynamic Electric Currents Equations](#)

Electric Currents, Single Layer Shell Equations in Steady State

In the static study type, the physics interface solves the following equation where d is the thickness (SI unit: m) of the shell:

$$-\nabla_t \cdot d(\sigma \nabla_t V - \mathbf{J}_e) = d\mathbf{Q}_j$$

σ is the electrical conductivity (SI unit: S/m), \mathbf{J}_e is an *externally generated current density* (SI unit: A/m²), and \mathbf{Q}_j is an external current source (SI unit: A/m³). The operator ∇_t represents the tangential derivative along the shell.

Dynamic Electric Currents Equations

In the Frequency Domain and Time Dependent study types dynamic formulations accounting for both conduction currents and displacement currents are used:

$$-\nabla_t \cdot d((\sigma + j\omega\epsilon_0)\nabla_t V - (\mathbf{J}_e + j\omega\mathbf{P})) = d\mathbf{Q}_j$$

For the transient case, the resulting equation becomes

$$-\nabla_t \cdot d\frac{\partial}{\partial t}((\epsilon_0\nabla_t V - \mathbf{P}) - \nabla_t \cdot d(\sigma \nabla_t V - \mathbf{J}_e)) = d\mathbf{Q}_j$$

Magnetic Field Interfaces

This chapter summarizes the functionality of the magnetic field interfaces found under the **Magnetic Fields, No Currents**, **Electromagnetic Fields** and **Electromagnetics and Mechanics** folders under the **AC/DC** branch ().

In this chapter:

- [The Magnetic Fields Interface](#)
- [The Magnetic Field Formulation Interface](#)
- [The Magnetic Fields, No Currents Interface](#)
- [The Magnetic Fields, No Currents, Boundary Elements Interface](#)
- [The Rotating Machinery, Magnetic Interface](#)
- [The Magnetic and Electric Fields Interface](#)
- [Theory for the Magnetic Fields Interface](#)
- [Theory for the Magnetic Field Formulation Interface](#)
- [Theory for the Magnetic Fields, No Currents Interface](#)
- [Theory for the Magnetic and Electric Fields Interface](#)

The Magnetic Fields Interface

The **Magnetic Fields (mf)** interface (), found under the **AC/DC>Electromagnetic Fields** branch when adding a physics interface, is used to compute magnetic field and induced current distributions in and around coils, conductors, and magnets. Depending on the licensed products, stationary, frequency-domain, small-signal analysis, and time-domain modeling are supported in 2D and 3D. Note that the frequency and time-domain formulations become ill-posed when approaching the static limit. You can extend the useful frequency range downward by adding a low conductivity.

The physics interface solves Maxwell's equations, which are formulated using the magnetic vector potential and, optionally for coils, the scalar electric potential as the dependent variables.

The main node is Ampère's Law, which adds the equation for the magnetic vector potential and provides an interface for defining the constitutive relations and its associated properties, such as the relative permeability.

When this physics interface is added, these default nodes are also added to the **Model Builder** — **Magnetic Fields**, **Ampère's Law**, **Magnetic Insulation** (the default boundary condition), and **Initial Values**. Then, from the **Physics** toolbar, add other nodes that implement boundary conditions and external currents. You can also right-click **Magnetic Fields** to select physics features from the context menu.

Physics-Controlled Mesh

The physics-controlled mesh is controlled from the **Mesh** node's **Settings** window (if the **Sequence type** is **Physics-controlled mesh**). There, in the table in the **Physics-Controlled Mesh** section, find the physics interface in the **Contributor** column and select or clear the check box in the **Use** column on the same table row for enabling (the default) or disabling contributions from the physics interface to the physics-controlled mesh.

Information from the physics, such as the presence of an infinite elements domain or periodic condition, will be used to automatically set up an appropriate mesh sequence.



In the *COMSOL Multiphysics Reference Manual* see the [Physics-Controlled Mesh](#) section for more information about how to define the physics-controlled mesh.

SETTINGS

The **Label** is the default physics interface name.

The **Name** is used primarily as a scope prefix for variables defined by the physics interface. Refer to such physics interface variables in expressions using the pattern `<name>.<variable_name>`. In order to distinguish between variables belonging to different physics interfaces, the `name` string must be unique. Only letters, numbers, and underscores (`_`) are permitted in the **Name** field. The first character must be a letter.

The default **Name** (for the first physics interface in the model) is `mf`.

BACKGROUND FIELD

This section allows the specification of a background magnetic vector potential (that generates a background magnetic flux density).

Select an option to **Solve for** — **Full field** (the default) or **Reduced field**. When **Reduced field** is selected, choose the Background field specification — **Magnetic vector potential** (the default) or **Uniform magnetic flux density**. Mathematically, the background field is always specified as a background magnetic vector potential. The **Uniform magnetic flux density** option will apply an appropriate magnetic vector potential generating the specified magnetic flux density. In axisymmetric geometries, the uniform background field is applied in the axial direction.

For **Magnetic vector potential**, enter values or expressions for the **Background magnetic vector potential** \mathbf{A}_b (SI unit: Wb/m). The defaults are 0 Wb/m. For **Uniform magnetic flux density**, in 2D or 3D components, enter the values or expressions of the components of the **Uniform magnetic flux density** \mathbf{B}_b (SI unit: T); in 2D axisymmetric components, enter the value or expression of the **Uniform axial magnetic flux density** $B_{b,z}$ (SI unit: T). The defaults are 0 T. The specified background magnetic flux densities must be uniform (space-independent), but they can be a function of time.

When a background field is active, this solves for the relative (perturbed) field only. This setting, together with the [External Magnetic Vector Potential](#) feature, is useful to introduce an external field generated by systems not included in the model.

COMPONENTS

This section is only available in 2D and 2D axially symmetric components.

The current vector has the same direction as the magnetic vector potential. This setting also controls the direction in which applied and induced currents can flow in the model. The default option is to solve for the out-of-plane component only for 2D and 2D axisymmetric components.

Select **Components** — **Out-of-plane vector potential** (the default), **In-plane vector potential**, or **Three-component vector potential** for the magnetic vector potential.

From the practical viewpoint this choice is equivalent to deciding in what directions the electric current is allowed to flow (out-of-plane currents, in-plane currents, or currents flowing in all three coordinate directions) and affects other settings in the model, for example, the **Port Properties>Type of port** section for the [Lumped Port](#) node.

When **In-plane vector potential** or **Three-component vector potential** is selected, the [Gauge Fixing for A-Field](#) node becomes available.

THICKNESS

For 2D components, enter a value or expression for the global **Out-of-plane thickness** d (SI unit: m). The default of 1 m is typically not representative for a thin domain. Instead it describes a unit thickness that makes the 2D equation identical to the equation used for 3D components.

Use the [Change Thickness \(Out-of-Plane\)](#) node (described for the Electrostatics interface) to define specific geometric entities (for example, domains) instead of a global setting for the thickness.

PORT SWEEP SETTINGS

Select the **Activate port sweep** check box to switch on the sweep and invoke a parametric sweep over the Lumped Port features. Enter a **Sweep parameter name** to indicate the name of the model parameter that controls the port activated in each step of the sweep. The default is `PortName`. The name given must match the model parameter, defined under **Global Definitions**, that is object of a **Parametric Sweep** node in the current **Study**.

The lumped parameters computed can be subject to a **Touchstone file export**. To activate this functionality, enter a file path or click **Browse** to navigate to a file. Select a **Parameter format (value pairs)** for the Touchstone export — **Magnitude and angle (MA)** (the default), **Magnitude in dB and angle (DB)**, or **Real and imaginary parts (RI)**. Select the desired operation to perform from the **If file exists** list — **Overwrite** (the default) or **Create new**. The latter is useful when the model is solved multiple times with different settings. Enter a **Reference impedance, Touchstone file export** Z_{ref} (SI unit: Ω). The default is 50 Ω .

ERROR CHECK



To display this section, click the **Show More Options** button () and select **Advanced Physics Options** in the **Show More Options** dialog box.

When the **Check applicability of features in study** check box is selected, any features that are incompatible with the study will generate an error message when trying to solve or show the default solver. No solver will be generated. Deselect it and you will be able to run the model, possibly with runtime errors instead. It is available to allow the advanced user to tweak any feature and use it outside of its intended study scope.

DEPENDENT VARIABLES

The dependent variable is the **Magnetic vector potential A** . You can change both its field name and the individual component variable names. If the new field name coincides with the name of another magnetic vector potential field in the model, the physics interfaces share degrees of freedom and component names. The new field name must not coincide with the name of a field of another type, or with a component name belonging to some other field. Component names must be unique within a model, except for fields of the same type sharing a common field name.

DISCRETIZATION

	<ul style="list-style-type: none">• Domain, Boundary, Point, and Pair Nodes for the Magnetic Fields Interface• Lumped Parameters• Theory for the Magnetic Fields Interface
	<p><i>Quadrupole Lens</i>: Application Library path COMSOL_Multiphysics/Electromagnetics/quadrupole</p>
	<p><i>Eddy Currents</i>: Application Library path ACDC_Module/Inductive_Devices_and_Coils/eddy_currents</p>

Domain, Boundary, Point, and Pair Nodes for the Magnetic Fields Interface

The Magnetic Fields interface has these domain, boundary, point, and pair nodes available, which are listed in alphabetical order.

About the Boundary Conditions

With no surface currents present, the physics interface conditions

$$\mathbf{n}_2 \times (\mathbf{A}_1 - \mathbf{A}_2) = \mathbf{0}$$

$$\mathbf{n}_2 \times (\mathbf{H}_1 - \mathbf{H}_2) = \mathbf{0}$$

need to be fulfilled. Because \mathbf{A} is being solved for, the tangential component of the magnetic potential is always continuous, and thus the first condition is automatically fulfilled. The second condition is equivalent to the natural boundary condition and is hence also fulfilled unless surface currents are explicitly introduced.

Table 5-1 lists the interior and exterior boundary conditions available with this physics interface.

TABLE 5-1: INTERIOR AND EXTERIOR BOUNDARY CONDITIONS FOR THE MAGNETIC FIELDS INTERFACE

NODE	INTERIOR	EXTERIOR
External Magnetic Vector Potential	x	x
Impedance Boundary Condition		x
Lumped Port	x	x
Magnetic Field		x
Magnetic Insulation	x	x
Magnetic Potential	x	x
Magnetic Shielding	x	
Perfect Magnetic Conductor	x	x
Periodic Condition		x
Surface Current Density	x	x
Surface Magnetic Current Density	x	x
Thin Low Permeability Gap	x	
Transition Boundary Condition	x	

Available Nodes

These nodes, listed in alphabetical order, are available from the **Physics** ribbon toolbar (Windows users), **Physics** context menu (Mac or Linux users), or by right-clicking to access the context menu (all users).



In general, to add a node, go to the **Physics** toolbar no matter what operating system you are using. Subnodes are available by clicking the parent node and selecting it from the **Attributes** menu.

Also see [Table 5-1](#) for a list of interior and exterior boundary conditions.

- [Ampère's Law](#)
- [Ampère's Law, Magnetostrictive](#)
- [Boundary Feed](#)
- [Coil Geometry](#)
- [Edge Current](#)
- [Electric Point Dipole](#)
- [External Current Density](#)
- [External Magnetic Vector Potential](#)
- [Force Calculation](#) (described for the Electrostatics interface)
- [Gap Feed](#)
- [Harmonic Perturbation](#)
- [Impedance Boundary Condition](#)
- [Initial Values](#)
- [Line Current \(Out-of-Plane\)](#)
- [Lumped Port](#)
- [Magnetic Field](#)
- [Magnetic Insulation](#) (the default boundary condition)
- [Magnetic Point Dipole](#)
- [Magnetic Point Dipole \(on Axis\)](#)
- [Magnetic Potential](#)
- [Magnetic Shielding](#)
- [Coil](#)
- [Perfect Magnetic Conductor](#)
- [Lumped Port](#)
- [Sector Symmetry](#)
- [Single-Turn Coil](#)
- [Surface Current Density](#)
- [Surface Magnetic Current Density](#)
- [Thin Low Permeability Gap](#)
- [Transition Boundary Condition](#)
- [Velocity \(Lorentz Term\)](#)



For 2D axisymmetric components, the COMSOL software takes the axial symmetry boundaries (at $r = 0$) into account and adds an **Axial Symmetry** node to the component that is valid on the axial symmetry boundaries only.



Infinite Elements, Perfectly Matched Layers, and Absorbing Layers in the *COMSOL Multiphysics Reference Manual*



In the *COMSOL Multiphysics Reference Manual*, see [Table 2-4](#) for links to common sections and [Table 2-5](#) for common feature nodes. You can also search for information: press F1 to open the **Help** window or Ctrl+F1 to open the **Documentation** window.

Ampère's Law

The **Ampère's Law** node adds Ampère's law for the magnetic field and provides an interface for defining the constitutive relation and its associated properties as well as electric properties.

MATERIAL TYPE

The **Material type** setting decides how materials behave and how material properties are interpreted when the mesh is deformed. Select **Solid** for materials whose properties change as functions of material strain, material orientation, and other variables evaluated in a material reference configuration (material frame). Select **Non-solid** for materials whose properties are defined only as functions of the current local state at each point in the spatial frame, and for which no unique material reference configuration can be defined. Select **From material** to pick up the corresponding setting from the domain material on each domain.

CONSTITUTIVE RELATION JC-E

This section is described for the [Current Conservation](#) feature.

The options **Effective medium** and **Archie's law** require additional subnodes. If **Effective medium** is selected, a [Effective Medium](#) subnode is available from the context menu (right-click the parent node) as well as from the **Physics** toolbar, **Attributes** menu. If **Archie's law** is selected, add an [Archie's Law](#) subnode in the same way. These subnodes contain additional settings to specify how the material properties are computed. **Effective medium** models a mixture of materials whose properties are computed by averaging the properties of the components. **Archie's law** models a conductive liquid in a nonconductive matrix.

CONSTITUTIVE RELATION D-E

The default **Relative permittivity** ϵ_r (dimensionless) for the media is used **From material** and defined on the shell domain. For **User defined**, select **Isotropic**, **Diagonal**, **Symmetric**, or **Full** based on the characteristics of the permittivity and then enter values or expressions in the field or matrix. If **Effective medium** is selected, a **Effective Medium** subnode is available from the context menu (right-click the parent node) as well as from the **Physics** toolbar, **Attributes** menu, which can specify the relative permittivity of the mixture.

CONSTITUTIVE RELATION B-H

Specify the constitutive relation that describes the macroscopic properties of the medium (relating the magnetic flux density **B** and the magnetic field **H**) and the applicable material properties, such as the relative permeability.

The equation for the selected constitutive relation displays under the list. For all options, the default uses values **From material**, or select **User defined** to enter a different value or expression.

Select a **Magnetization model**— **Relative permeability** (the default), **B-H curve**, **Magnetic losses**, **Remanent flux density**, **Magnetization**, **Effective B-H curve**, **Hysteresis Jiles-Atherton model**, **Nonlinear permanent magnet**, or **External material**.

Relative Permeability

Select **Relative permeability** μ_r (dimensionless) to use the constitutive relation $\mathbf{B} = \mu_0 \mu_r \mathbf{H}$. For **User defined** select **Isotropic**, **Diagonal**, **Symmetric**, or **Full** and enter values or expressions in the field or matrix. If **Effective medium** is selected, a **Effective Medium** subnode is available from the context menu (right-click the parent node) as well as from the **Physics** toolbar, **Attributes** menu, which can specify the relative permeability of the mixture.

B-H Curve

Select **B-H curve** $|\mathbf{H}|$ (SI unit: A/m) to use a curve that relates magnetic flux density **B** and the magnetic field **H** as $|\mathbf{H}| = f(|\mathbf{B}|)$.

The **Magnetic field norm** and **Magnetic coenergy density** settings can take the values **From material** or **User defined**.

When **User defined** is selected, specify a user-defined expression for the magnetic field norm. The direction of the magnetic field is taken to be the same as the direction of the magnetic flux density at each point.



Do not select this option in a Frequency Domain study, such as when using [The Induction Heating Interface](#). This option is not relevant for time harmonic modeling, which assumes linear material properties.

Magnetic Losses

This option introduces a complex relative permeability and it is intended for time-harmonic (frequency domain) studies. Therefore, it is not available for [The Magnetic Fields, No Currents Interface](#).

Select **Magnetic losses** μ' and μ'' (dimensionless) to describe the relative permeability as a complex-valued quantity: $\mu_r = \mu' + i\mu''$, where μ' and μ'' are the real and imaginary parts, respectively.

Remanent Flux Density

Select **Remanent flux density** \mathbf{B}_r (SI unit: T) to use the constitutive relation $\mathbf{B} = \mu_0\mu_{\text{rec}}\mathbf{H} + \mathbf{B}_r$, where μ_{rec} and \mathbf{B}_r are the recoil permeability and the remanent flux density respectively (the flux density when no magnetic field is present). The recoil permeability μ_{rec} is very similar to the relative permeability, and is valid as long as the magnet is subjected to normal operating conditions (it is only valid within the linear region close to the vertical axis $\mathbf{H} = 0$). \mathbf{B}_r is given by taking the remanent flux density norm (typically, provided by the material) and multiplying it with a normalized direction field specified in the physics: $\mathbf{B}_r = \|\mathbf{B}_r\| \mathbf{e}/\|\mathbf{e}\|$.

- The default recoil permeability μ_{rec} (dimensionless) uses values **From material**. For **User defined**, select **Isotropic**, **Diagonal**, **Symmetric**, or **Full** based on the characteristics of the recoil permeability and enter another value or expression in the field or matrix.
- The remanent flux density norm $\|\mathbf{B}_r\|$ is taken **From material** by default. *The AC/DC branch in the material library contains a number of hard magnetic materials specifically for this purpose.* Alternatively, chose **User defined**, and specify your own expression.
- Enter **x** and **y** components for the **Remanent flux direction** \mathbf{e} . For 3D components, enter **x**, **y**, and **z** components.

Magnetization

Select **Magnetization \mathbf{M}** (SI unit: A/m) to use the constitutive relation $\mathbf{B} = \mu_0\mathbf{H} + \mu_0\mathbf{M}$. Enter **x** and **y** components. For 3D components, enter **x**, **y**, and **z** components.

Effective B-H Curve

Select **Effective B-H curve $|\mathbf{H}|_{\text{eff}}$** (SI unit: A/m) to use an effective curve that provides the local linearized relation between the magnetic flux density \mathbf{B} and the magnetic field \mathbf{H} in time-harmonic problems.



This option is designed for time-harmonic (Frequency domain) problems and implements an effective saturation model for nonlinear materials. See [Effective Nonlinear Magnetic Constitutive Relations](#) for more information.

Nonlinear Permanent Magnet

Select **Nonlinear permanent magnet** to use a nonlinear BH-relation that is isotropic around a point in \mathbf{H} space that is shifted by the coercive field \mathbf{H}_c . This constitutive relation is intended for easy modeling of self-demagnetization of soft permanent magnets. It is recommended to keep all input settings at the default **From material** and use the example material, **Nonlinear Permanent Magnet** in the **AC/DC** material database either as is or as a template for defining customized materials. The latter is done by changing the interpolation functions defined in the material. That material is a generic/approximate representation of AlNiCo 5.

The **Direction of magnetization** is the only input that normally should be entered in the physics.



Do not select this option in a Frequency Domain study, such as when using [The Induction Heating Interface](#). This option is not relevant for time harmonic modeling, which assumes linear material properties.



See also [Effective Nonlinear Magnetic Constitutive Relations](#) in the theory section.

Hysteresis Jiles-Atherton model

Select the **Hysteresis Jiles-Atherton model** to use in the constitutive relation $\mathbf{B} = \mu_0\mathbf{H} + \mu_0\mathbf{M}$ with the magnetization \mathbf{M} (SI unit: A/m) computed from the solution of the 5 parameters Jiles-Atherton model. Specify the five parameters \mathbf{M}_s , \mathbf{a} , \mathbf{k} ,

\mathbf{c} , and α either from the material (default) or as user defined. The example material **Jiles-Atherton Hysteretic Material** is available in the AC/DC material library. The parameters may be tensor quantities resulting in the modeling of an anisotropic hysteretic material as shown in the application library entry:



Vector Hysteresis Modeling: Application Library path
ACDC_Module/Other_Industrial_Applications/vector_hysteresis_modeling

An entry **Initial Magnetization** is present to set the initial values of Jiles-Atherton variables.

The **Discretization** section is used to choose the discretization order of Jiles-Atherton variables.



For a more thorough description of the model, its parameters and literature references, see [The Jiles-Atherton Hysteresis Model](#) in the theory section.

External Material

Select **External material** to use a curve that relates magnetic flux density \mathbf{B} and the magnetic field \mathbf{H} as $|\mathbf{H}| = f(|\mathbf{B}|)$ according to an externally coded function.

Specify the **External material** to use (from the **Materials** node under **Global Definitions**). This setting allows using material models or constitutive relations defined in an external library. See [Working with External Materials](#) for more information.

Ampère's Law, Magnetostrictive

The **Ampère's Law, Magnetostrictive** node adds Ampère's law for the magnetic field in a magnetostrictive material and provides an interface for defining the electric properties. It is normally used as part of [Magnetostriction](#) multiphysics interface together with a **Magnetostriction** multiphysics coupling node and **Magnetostrictive Material** node in the corresponding **Solid Mechanics** interface. **Ampère's Law, Magnetostrictive** node is added by default to the **Magnetic Fields** interface when adding

a Magnetostriction multiphysics interface. The interface requires the AC/DC Module and at least one of the following modules: Structural Mechanics, MEMS, Acoustics.



When the **Ampère's Law, Magnetostrictive** node is added to the Magnetic Fields interface in the absence of an active **Magnetostriction** multiphysics coupling node, the material behaves similarly to an **Ampère's Law** node with some limitations. Thus, the magnetic permittivity of free space will be assumed. The magnetostrictive effect is then *not* included in the corresponding equation system.

CONDUCTION CURRENT

This section is described for the [Current Conservation](#) feature.

ELECTRIC FIELD

The default **Relative permittivity** ϵ_r (dimensionless) for the media is used **From material** and defined on the shell domain. For **User defined**, select **Isotropic, Diagonal, Symmetric**, or **Full** based on the characteristics of the permittivity and then enter values or expressions in the field or matrix.

MAGNETIC FIELD

Specify the constitutive relation that describes the macroscopic properties of the medium (relating the magnetic flux density **B** and the magnetic field **H**) for a magnetostrictive material:

$$\mathbf{B} = \mu_0[\mathbf{H} + \mathbf{M}(\mathbf{H}, S_{\text{mech}}) + \mathbf{M}_r]$$

where $\mathbf{M}(\mathbf{H}, S_{\text{mech}})$ is material magnetization which depends on the magnetic field and mechanical stress; a particular form of this dependency can be specified under the corresponding **Magnetostrictive Material** node in the **Solid Mechanics** interface.

\mathbf{M}_r is the remanent magnetization (SI unit: A/m). Enter **X** and **Y** components. For 3D components, enter **X**, **Y**, and **Z** components.



- [Magnetostriction](#)
- [Modeling Magnetostrictive Materials](#)
- [Magnetostrictive Material](#)

Initial Values

The **Initial Values** node adds an initial value for the magnetic vector potential A that can serve as an initial value for a transient simulation or as an initial guess for a nonlinear solver.

INITIAL VALUES

Enter values or expressions for the **Magnetic vector potential A** (SI unit: Wb/m). The defaults are 0 Wb/m.

External Current Density

The **External Current Density** node adds an externally generated current density \mathbf{J}_e , which appears on the right-hand side of the equation that the Magnetic Fields interface defines.

Add a contribution as a **Harmonic Perturbation** by right-clicking the parent node or clicking **Harmonic Perturbation** on the **Physics** toolbar. For more information see [Harmonic Perturbation — Exclusive and Contributing Nodes](#) in the *COMSOL Multiphysics Reference Manual*.

EXTERNAL CURRENT DENSITY

Enter a value or expression for each component of the **External current density \mathbf{J}_e** (SI unit: A/m²). The defaults are 0 A/m².

The external current density does not contribute to the losses (due to Joule heating), since there is no electric field associated with it. To include the contribution to the losses from the external current density, select the **Add contribution of the external current density to the losses** check box. Then select an option from the **External losses** list — **From domain conductivity** (the default) or **User defined**. If **From domain conductivity** is selected, the heat source is computed using the conductivity specified in the material model feature (such as **Ampère's Law**) that is applied in the domain. For **User defined**, enter a value for Q_e (SI unit: W/m³) to specify a user-defined heat source.

Velocity (Lorentz Term)

This node is only valid in 2D and 2D axisymmetry when only solving for the out-of-plane component of the magnetic vector potential.



Correct use of the velocity feature requires deep physical insight. In situations when the moving domain is of bounded extent in the direction of the motion, material properties vary in this direction, or the domains contains magnetic sources that also move, the Lorentz term must not be used.

The **Velocity (Lorentz term)** node adds velocity \mathbf{v} . The external current is equal to $\sigma\mathbf{v} \times \mathbf{B}$. It also only valid when solving for both the electric potential and the magnetic vector potential using [The Magnetic and Electric Fields Interface](#).

An operational definition of when it can be used is that the moving domain should only contain an induced magnetic source (magnetization plus eddy currents) that has to be stationary with respect to the motion. Thus, it cannot be used for modeling projectiles of finite length or projectiles containing magnets. It can be used to model conductive, homogeneous spinning disks (magnetic brakes); magnets over a moving infinite homogeneous plane (maglev trains); and flow of homogeneous conducting fluid past a magnet (liquid metal pumps or Hall generators/thrusters, for example).



If you are not sure how to proceed, contact the COMSOL Support Center: <http://www.comsol.com/support>.

VELOCITY (LORENTZ TERM)

User defined is selected by default. Enter the components for the **Velocity** vector \mathbf{v} (SI unit: m/s) or, if present, select any velocity field defined in the model. For example, using the velocity field is useful when coupling to the velocity field of a fluid for a magnetohydrodynamic model.

Magnetic Insulation

The **Magnetic Insulation** node is the default boundary condition for the Magnetic Fields interface and adds a boundary condition that sets the tangential components of the magnetic potential to zero at the boundary $\mathbf{n} \times \mathbf{A} = 0$.

Magnetic insulation is a special case of the magnetic potential boundary condition that sets the tangential component of the magnetic potential to zero.

This node is used for the modeling of a lossless metallic surface, for example, a ground plane or as a symmetry type boundary condition. The node imposes symmetry for magnetic fields and “magnetic currents.” In the transient and time harmonic formulations, it also imposes antisymmetry for electric fields and electric currents. The node supports induced electric surface currents and thus any prescribed or induced electric currents (volume, surface, or edge currents) flowing into a perfect electric conductor boundary are automatically balanced by induced surface currents.

The Magnetic Insulation node can also be applied on interior boundaries. The boundary will then support two surface current densities on the two sides, denoted by J_{su} (upside) and J_{sd} (downside).

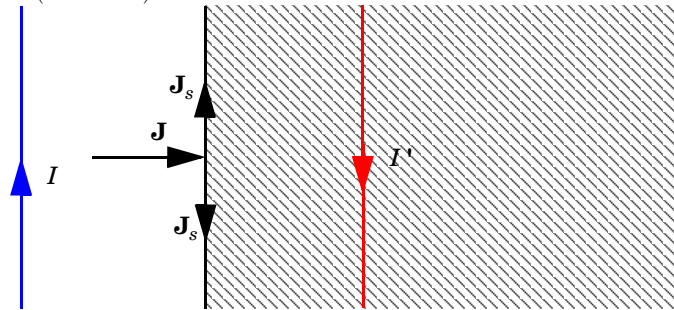



Figure 5-1: The magnetic insulation boundary condition is used on exterior and interior boundaries representing the surface of a lossless metallic conductor or (on exterior boundaries) a symmetry cut. The shaded (metallic) region is not part of the model but still carries effective mirror images of the sources. Note also that any current flowing into the boundary is perfectly balanced by induced surface currents. The tangential vector potential (and electric field) vanishes at the boundary.

CONSTRAINT SETTINGS

To display this section, click the **Show More Options** button () and select **Advanced Physics Options** in the **Show More Options** dialog box.



Weak constraints perform poorly when applied on vector elements. They should be used when the magnetic vector potential is discretized with Lagrange elements, for example, when solving for out-of-plane component in a two-dimensional component.

Magnetic Field

The **Magnetic Field** node adds a boundary condition for specifying the tangential component of the magnetic field at the boundary:

$$\mathbf{n} \times \mathbf{H} = \mathbf{n} \times \mathbf{H}_0$$

The **Harmonic Perturbation** subnode (it is of the exclusive type) is available from the context menu (right-click the parent node) or on the **Physics** toolbar by clicking the **Attributes** menu and selecting **Harmonic Perturbation**. For more information see [Harmonic Perturbation — Exclusive and Contributing Nodes](#) in the *COMSOL Multiphysics Reference Manual*.

MAGNETIC FIELD

Enter the value or expression for the **Magnetic Field** \mathbf{H}_0 (SI unit: A/m) vector coordinates. The defaults are 0 A/m.

CONSTRAINT SETTINGS

To display this section, click the **Show More Options** button () and select **Advanced Physics Options** in the **Show More Options** dialog box.

Surface Current Density

The **Surface Current** node adds a boundary condition for a surface current density \mathbf{J}_s :

$$\begin{aligned} -\mathbf{n} \times \mathbf{H} &= \mathbf{J}_s \\ \mathbf{n} \times (\mathbf{H}_1 - \mathbf{H}_2) &= \mathbf{J}_s \end{aligned}$$

These expressions apply to exterior and interior boundaries respectively. Add a contribution as a **Harmonic Perturbation** by right-clicking the parent node or clicking **Harmonic Perturbation** on the **Physics** toolbar. For more information see [Harmonic Perturbation — Exclusive and Contributing Nodes](#) in the *COMSOL Multiphysics Reference Manual*.

SURFACE CURRENT

Enter values or expressions for the **Surface current density** \mathbf{J}_{s0} (SI unit: A/m) coordinates. The defaults are 0 A/m.

Surface Magnetic Current Density

The **Surface Magnetic Current Density** boundary condition

$$\mathbf{n} \times \mathbf{E} = \mathbf{J}_{ms}$$
$$\mathbf{n}_2 \times (\mathbf{E}_1 - \mathbf{E}_2) = -\mathbf{J}_{ms}$$

specifies a surface magnetic current density at both exterior and interior boundaries, respectively. The magnetic current density is specified as a three-dimensional vector, but because it needs to flow along the boundary surface, COMSOL Multiphysics projects it onto the boundary surface and neglects its normal component. This makes it easier to specify the magnetic current density and avoids unexpected results when a magnetic current density with a component normal to the surface is given.

SURFACE MAGNETIC CURRENT DENSITY

Enter values or expressions for the components of the **Surface magnetic current density** \mathbf{J}_{ms0} (SI unit: V/m).

Magnetic Potential

The **Magnetic Potential** node adds a boundary condition for the magnetic vector potential:

$$\mathbf{n} \times \mathbf{A} = \mathbf{n} \times \mathbf{A}_0$$

MAGNETIC POTENTIAL

Enter a value or expression for the **Magnetic vector potential** \mathbf{A}_0 (SI unit: Wb/m) coordinates.

CONSTRAINT SETTINGS

To display this section, click the **Show More Options** button () and select **Advanced Physics Options** in the **Show More Options** dialog box.

Perfect Magnetic Conductor

The **Perfect Magnetic Conductor** boundary condition $\mathbf{n} \times \mathbf{H} = 0$ is a special case of the surface current boundary condition that sets the tangential component of the magnetic field and thus also the surface current density to zero. On external boundaries, this can be interpreted as a “high surface impedance” boundary condition or used as a symmetry type boundary condition. It imposes symmetry for electric fields

and electric currents. Electric currents (volume, surface, or edge currents) are not allowed to flow into a perfect magnetic conductor boundary as that would violate current conservation. On interior boundaries, the perfect magnetic conductor boundary condition literally sets the tangential magnetic field to zero, which, in addition to setting the surface current density to zero, also makes the tangential magnetic vector potential (and in dynamics the tangential electric field) discontinuous.

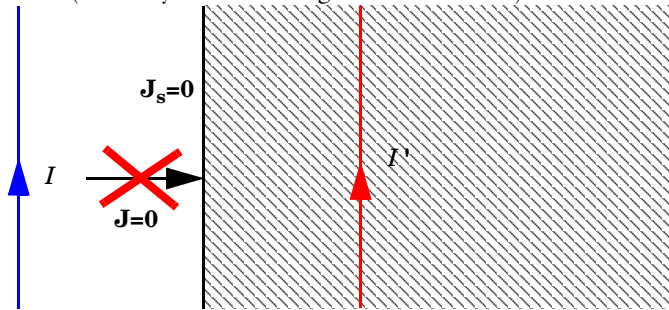



Figure 5-2: The perfect magnetic conductor boundary condition is used on exterior boundaries representing the surface of a high impedance region or a symmetry cut. The shaded (high impedance) region is not part of the model but nevertheless carries effective mirror images of the sources. Note also that any electric current flowing into the boundary is forbidden as it cannot be balanced by induced electric surface currents. The tangential magnetic field vanishes at the boundary.

CONSTRAINT SETTINGS

To display this section, click the **Show More Options** button () and select **Advanced Physics Options** in the **Show More Options** dialog box.

Line Current (Out-of-Plane)

Use the **Line Current (Out-of-Plane)** node, selected from the **Points** menu, to specify a line current out of the modeling plane. In axially symmetric geometries this is the rotational (azimuthal) direction; in 2D geometries this is the z direction.

LINE CURRENT (OUT-OF-PLANE)

Enter a value or expression for the **Out-of-plane current** I_0 (SI unit: A).

Line Current (on Axis)

The **Line Current (on Axis)** feature is available for 2D axisymmetric components. It applies to edges that coincide with the symmetry axis, and is active only when in-plane magnetic vector potential components are available (for more information, see

Components). Use the **Line Current (on Axis)** feature to specify a line current along the symmetry axis.

LINE CURRENT (ON AXIS)

Enter a value or expression for the **Line current in z direction** I_z (SI unit: A).

Electric Point Dipole

Add **Electric Point Dipole** nodes to 3D and 2D components. This represents the limiting case of when the length d of a current filament carrying uniform current I approaches zero while maintaining the product between I and d . The dipole moment is a vector entity with the positive direction set by the current flow.

DIPOLE SPECIFICATION

Select a **Dipole specification** — **Magnitude and direction** (the default) or **Dipole moment**.

DIPOLE PARAMETERS

Under **Dipole specification**:

- For **Magnitude and direction** enter coordinates for the **Electric current dipole moment direction** \mathbf{n}_p (the defaults are 0) and **Electric current dipole moment, magnitude** p (SI unit: Am) (the default is 0 Am).
- For **Dipole moment** enter coordinates for the **Electric current dipole moment** \mathbf{p} (SI unit: Am). The defaults are 0 Am.

Gauge Fixing for A-Field



For 2D and 2D axisymmetric components. Gauge fixing is available when vector (curl) shape functions are used, that is, when having in-plane dependent variables. The node is made available when **In-plane vector potential** or **Three-component vector potential** is selected from the **Components** section on the **Settings** window for [The Magnetic Fields Interface](#).

The **Gauge Fixing for A-Field** node enforces the gauge $\nabla \cdot \mathbf{A} = 0$ by adding an additional potential variable, ψ , and its associated conservation equation to the system. This is

often necessary to get a unique and numerically stable solution to the equation solving for the magnetic vector potential \mathbf{A} .



Explicit Gauge Fixing/Divergence Constraint

DOMAIN SELECTION

From the **Selection** list, choose the domains to define the gauge-fixing potential ψ . In most cases, the feature should be applied to all domains where the magnetic vector potential \mathbf{A} is solved for. By default, the selection is set to **All domains**, ensuring that the gauge fixing is applied to all the valid domains in the model.

GAUGE FIXING FOR A-FIELD

The **Equation form** is set to **Study controlled** by default. For Time Dependent and Frequency Domain studies, set **Equation form** to **Stationary** can be efficient to handle regions without conductivity.

The variable ψ is used to impose a condition on the derivatives of the magnetic vector potential, so its absolute value does not have particular significance; only its gradient enters the equations (the variable ψ acts more or less like a potential). The absolute value of the variable can be set by entering the **Divergence condition variable scaling** ψ_0 (SI unit: A/m). The default value is 1 A/m, which is appropriate for most models.

ADVANCED SETTINGS

To display this section, click the **Show More Options** button () and select **Advanced Physics Options** in the **Show More Options** dialog box.

This section allows a more fine control on the boundary conditions for ψ applied by the **Gauge Fixing** feature. The domain equation for ψ only imposes a condition on the gradient, so it is important to constrain the absolute value of ψ to ensure a nonsingular model. The **Constant value on insulation boundaries** check box (selected by default) imposes a constant value on the conductive boundaries in the model, such as [Magnetic Insulation](#). Select the **Method** to enforce this condition: **Constrain value** (the default) or **Constrain tangential gradient**.

If there are no such boundaries, select the **Ensure constraint on value** to ensure that there is always a constraint set (at least in one point) on the value of the divergence condition variable ψ .



If you apply **Gauge Fixing** across pair boundaries, the internal logic for constraining ψ in at least one point does not work. The problem is most likely to appear in gauge fixing for rotating machinery. Assume you have one gauge fixed **Ampère's Law** domain in the stator and one in the rotor, then one must use separate **Gauge Fixing** features for these as the geometry analysis for setting up point constraints on ψ does not work across pairs. It can also be handled by adding manual constraints on ψ .



Applying **Gauge Fixing** to nonlinear models, for example with materials involving magnetic saturation has the known side-effect that the nonlinear solver fails to converge for models with zero or numerically small excitation. Thus, starting for example parametric sweeps from exactly zero applied source currents should be avoided.

Coil

The **Coil** node can be used to model coils, cables and other conductors subject to a lumped excitation, such as an externally applied current or voltage. The Coil feature transforms this lumped excitation into local quantities (electric field and electric current density), and computes lumped parameters of interest such as impedance, and inductance.

The **Coil** feature supports two different **Conductor models**:

- **Single conductor**, which models a conductive body such as a wire, busbar, or other metallic conductor in which the current flows freely due to the material's conductivity. This model can be used when the current flow has a well-defined beginning and end (for example, connections to an external source) or is closed in a loop.



The **Domain Selection** has to be complete in the sense that selecting only part of a contiguous conductor will lead to unphysical results.

- **Homogenized multi-turn**, which models a bundle of tiny wires tightly wound together but separated by an electrical insulator. In this scenario, the current flows only in the direction of the wires and is negligible in other directions.

The **Coil** feature is available both for domain and for boundary selections. In the latter case, it represents a flat coil or a conductor with a thickness negligible compared with the other dimensions. Different subnodes can be added to the **Coil** node in different cases.

The global [Harmonic Perturbation](#) subnode is available from the context menu (right-click the parent node and select it from the **Global** menu) or from the **Physics** toolbar, **Attributes** menu. The subnode can be used to apply a harmonic perturbation to the coil excitation.

In 2D and 2D axisymmetric components, the **Coil** feature supports the **Coil group** functionality, that can be activated by selecting the corresponding check box.



The **Coil group** option assumes that the selected domains represent cross sections of the same conductor going in and out of the modeling plane. These are expected to have the same areas. The same total current will be imposed in each domain, even if the domain areas are not equal but the computed concatenated flux, coil voltage and inductance will be incorrect. For cases with varying cross section areas, it is recommended to use separate coil features that are coupled using [The Electrical Circuit Interface](#).

Refer to the [Coil Features](#) section in the modeling guide for more information about this node.



In 2D and 2D axisymmetric components, the wires are assumed to be in the out-of-plane direction.



See [Coil Features](#) in this guide to learn more about using this feature.

MATERIAL TYPE

The **Material type** setting decides how materials behave and how material properties are interpreted when the mesh is deformed. Select **Solid** for materials whose properties change as functions of material strain, material orientation and other variables evaluated in a material reference configuration (material frame). Select **Nonsolid** for materials whose properties are defined only as functions of the current local state at each point in the spatial frame, and for which no unique material reference configuration can be defined. Select **From material** to pick up the corresponding setting from the domain material on each domain. Since **Coil** features model conductors or bundles of wires, the correct choice is usually **Solid**.

COIL

Coil Name

Enter a **Coil name**. This name is appended to the global variables (current, voltage) defined by this coil, and it can be used to identify the coil in a **Coil Geometry Analysis** study step.

Conductor Model

Select the **Conductor model** for the coil. The choices correspond to rather different physical model, although the set up is similar. The **Single conductor** model (the default) is appropriate for solid, massive current-carrying conductors. The **Homogenized multi-turn** model represent a bundle of tiny wires that are not geometrically resolved but taken into account in their average effect. The choice of **Conductor model** affects the controls that are visible in the GUI and the available subnodes for the Coil feature.

Coil Type (3D Homogenized Multi-Turn)

This section is available when selecting **Homogenized multi-turn** as the **Conductor model** in 3D components and is used to specify the coil geometry (the direction of the wires).

Select a **Coil Type** — **Linear** (the default), **Circular**, **Numeric**, or **User defined**. The different alternatives are described in the following sections. Also see [Using Coils in 3D Models](#) for more information.



An additional subnode is needed to completely define the coil geometry:

- For **Linear** or **Circular** the [Coil Geometry](#) subnode is added by default.
 - For **User defined** the [User Defined Coil Geometry](#) subnode is added by default.
 - For **Numeric** the [Geometry Analysis](#) subnode is added by default.
-

When **Single conductor** is selected as the **Conductor model**, the coil behaves as if **Coil Type** is **Numeric**, including the presence of the [Geometry Analysis](#) subnode.

Linear Coil Types

In a **Linear** coil, all the wires are parallel and straight lines. Use the [Coil Geometry](#) subnode to select an edge or a single group of connected edges that maps out the local coil direction. The direction of the wires and the coil length is taken to be the direction and the length of the edge(s), as marked by the red arrow. Avoid selecting multiple parallel edge groups as that will result in an incorrect coil length.

To respect the current conservation law, the applied currents cannot originate from interior boundaries. A Linear coil should therefore be terminated on exterior boundaries.

Circular Coil Types

In a **Circular** coil, the wires are wound in circles around the same axis. Use the [Coil Geometry](#) subnode to select a group of edges forming a circle or a part of a circle around the coil's axis. From the selected edges, the coil axis is computed and the direction of the wires is taken to be the azimuthal direction around the axis, as marked by the red arrows. The coil length used is computed as the coil volume divided by the coil cross sectional area, unless the **Use robust geometry analysis method** box is checked. When the robust method is used, the coil length is simply the length of the selected edges.

Numeric Coil Types

This option is available at the domain level only. In a **Numeric** coil, the current flow is computed automatically in a **Coil Geometry Analysis** study step. Use the [Geometry Analysis](#) subnode to set up the problem.



Automatic Coil Geometry Analysis

User Defined Coil Types

For **User defined** manually specify the direction of the wires as a vector field and the length of the coil. Use the [User Defined Coil Geometry](#) subnode to specify the coil geometry.

Coil Group (2D and 2D Axisymmetric Components)

The **Coil group** check box is only available for 2D and 2D axisymmetric components. Select this check box to enable the **Coil group** mode for this feature. With this settings,

the domains or domain groups in this feature's selection are considered series-connected. Selecting this check box activates the Domain Group subnode. See [Coil Groups](#) for more information.

Coil Excitation

Select a **Coil excitation** — **Current** (the default), **Voltage**, **Circuit (voltage)**, **Circuit (current)**, or **Power** (2D and 2D axisymmetric components only).

- **Current** forces a total current flowing in the coil wire. Enter a **Coil current** I_{coil} (SI unit: A). The default is 1 A. See the box below for study limitations on this setting.
- **Voltage** applies a total voltage across the coil enter a **Coil voltage** V_{coil} (SI unit: V). The default is 1 V.
- **Circuit (current)** works similarly to the **Current** excitation, but in this case the inputs are provided by a circuit connection.
- **Circuit (voltage)** works similarly to the **Voltage** excitation, but in this case the inputs are provided by a circuit connection.
- **Power** (only available for 2D and 2D axisymmetric components) forces the coil input power (cycle-average in frequency studies) to the specified value. Choosing this option makes the problem nonlinear. For **Power** enter a **Coil power** P_{coil} (SI unit: W). The default value is 1 W.



When using the **Current**, **Circuit (current)** and **Power** options, the coil feature sets up a control problem for the coil voltage and current. Due to its complexity, the following limitations apply:

- The **Power** option is only available for 2D and 2D axisymmetric components.
- The **Current** and **Circuit (current)** options should be used with care in **Time Dependent** study steps. One should avoid applying a current step excitation (for example a fixed nonzero current) as that will lead to unphysical results and/or numerical instability.
- See [Coil Features](#) in this guide to learn more about using this feature.

CONDUCTION CURRENT

This section is available only when **Single conductor** is selected as the **Coil model**. In this case, the coil represents a solid, massive conductor and the conductivity of the material is required to compute the current density flowing in it.

This section is identical to the one in the [Ampère's Law](#) node.

HOMOGENIZED MULTI-TURN

This section is available only when **Homogenized multi-turn** is selected as the **Coil model**. In this case, the coil represents a bundle of tiny wires separated by an insulator. Additional settings can be specified.

Number of Turns

Enter the **Number of turns** N . The default is 10. This is the number of tiny wires constituting the coil. The coil resistance is affected by this number and so is the current density in the coil as it together with the **Current** setting defines the number of Ampère-turns in the coil.

Coil Wire Conductivity

Enter a **Coil wire conductivity** σ_{coil} (SI unit: S/m). The default value is approximately the conductivity for copper, $6 \cdot 10^7$ S/m. This parameter represents the conductivity of the metal wires forming the coil. This is not the bulk conductivity of the material, which is instead set to zero according to the lumped model of a bundle of wires.

Coil Wire Cross-Section Area

Enter the cross-section area of the individual wire in the bundle. It is used, for example, to compute the lumped resistance of the coil. The area can be specified in different ways, according to the option selected in the **Coil wire cross-section area** list — **User defined** (the default), **Standard wire gauge**, **American wire gauge (Brown & Sharpe)**, or **From round wire diameter**.

- For **User defined**, enter the value of the cross section area a_{coil} (SI unit: m^2). The default is 10^{-6} m^2 .
- For **Standard wire gauge**, enter the SWG size. Sizes between 7/0 and 50 are available. The default size is 0.
- For **American wire gauge (Brown & Sharpe)**, enter the AWG size. Sizes between 0000 and 40 are available. Sizes such as 0000 can be also written as 4/0. The default size is 0.
- For **From round wire diameter**, enter the diameter of the individual wire d_{coil} (SI unit: m). The cross-section area of the round wire will be computed from it. The default value of d_{coil} is 1 mm.

MAGNETIC FIELD AND ELECTRIC FIELD

At the domain level, the Coil node replaces the [Ampère's Law](#) node in the definition of the material model for the domain. The **Settings** window for the domain node

contains the sections **Magnetic Field** and **Electric Field**, identical to the ones in the [Ampère's Law](#) node.

When **Single conductor** is selected as the **Conductor model**, the material properties to be specified are the ones of the material constituting the domain. When **Homogenized multi-turn** is selected, specify the homogenized material properties of the domain, that is, the homogenized properties of the conducting wires and the surrounding insulator.

STABILIZATION

To display this section, click the **Show More Options** button () and select **Stabilization** in the **Show More Options** dialog box. This section is available only in 3D components when using **Homogenized multi-turn** as the **Conductor model** and it contains advanced settings relative to the accuracy and stabilization of the solution.

The **Accurate coil voltage calculation** check box enables a current filtering functionality that improves the accuracy of the computed electric field and the induced coil voltage, at the cost of a slightly increased number of degrees of freedom. This functionality is only applicable for time dependent and frequency domain studies, and is active by default.

For the purpose of stabilizing the solution, the coil feature can apply a small electric conductivity to the coil domain. Use the **Stabilization** combo box to specify the value of the conductivity. Choose **Automatic** (the default) to use a conductivity automatically computed by the coil. In frequency domain studies, the conductivity is chosen so that the skin depth in the coil is much larger than the coil length (see the sections [Coil Geometry](#) and [User Defined Coil Geometry](#) below). It is deduced from the formula

$$\delta = \sqrt{\frac{2}{\omega\mu(0.001\sigma)}}$$

by setting the coil length, equal to the skin depth δ . In other study types the conductivity is set to 0.6 S/m.

If **None** is chosen, no conductivity is used in the coil domain. Choose **User defined** to specify the **Electrical conductivity in the coil domain** σ_{Ω} (SI unit: S/m). The default value is 1 S/m. The purpose of this electrical conductivity is only to stabilize the

solution. According to the Homogenized multi-turn model, the domain should not be conductive and all the currents should flow in the direction of the wires only.



- [Coil Excitation](#)
- [Power Excitation](#)
- [Using Coils in 3D Models](#)

Harmonic Perturbation

The **Harmonic Perturbation** subnode is available at the global level from the context menu (right-click the **Coil** parent node) or from the **Physics** toolbar, **Attributes** menu. Use this feature to specify a harmonic perturbation for the coil excitation.

COIL

A harmonic perturbation can be specified only if the **Coil excitation** of the parent feature is **Coil current** or **Coil voltage**. In the first case, enter a **Coil current** I_{coil} (SI unit: A). The default is 1 A. In the second case, enter a **Coil voltage** V_{coil} (SI unit: V). The default is 1 V.



[Harmonic Perturbation, Prestressed Analysis, and Small-Signal Analysis](#)
in the *COMSOL Multiphysics Reference Manual*

Coil Geometry

The **Coil Geometry** subnode of the **Coil** is available if the **Conductor model** of the parent feature is **Homogenized multi-turn** and the **Coil type** is **Linear** or **Circular**. This feature was previously called **Reference Edge**. This subnode is used to specify the direction of the tiny wires constituting the multi-turn coil.

- In **Linear** coils, the wires are all parallel and straight lines. Select an edge or a group of co-linear edges. The direction of the wires and the coil length is taken to be the direction and the length of the edges. To avoid unphysical currents, a **Linear** coil should be terminated on external boundaries.
- In **Circular** coils, the wires are wound in circles around the same axis. Select a group of edges forming a circle or a part of a circle around the coil's axis. From the selected edges, the coil axis is computed, and the direction of the wires is taken to be the azimuthal direction around the axis. The coil length used is computed as the coil

volume divided by the coil cross-sectional area, unless the **Use robust geometry analysis method** box is checked. When the robust method is used, the coil length is simply the length of the selected edges.

Select the **Use robust geometry analysis method** check box to use an alternative algorithm for the computation of the coil axis and direction. This method works even in models without geometry (for example, with an imported mesh), but requires that the selected edges form a complete circle.

COIL GEOMETRY

- The direction of the coil is shown in the **Graphics** window with a red arrow. Select the **Reverse direction** check box to reverse the direction of the coil.
- The length of the coil is computed from the length of the selected edges. To manually specify the length, select the **Override length of the edges** check box, and enter the **Total length of the edges** L_{edges} (SI unit: m).
- In domain features, the average cross-section area of the domain is computed automatically from the domain volume and the length of the edges. The cross-section area is used, for example, to compute the coil current density. To manually specify a cross-section area, select the **Override domain area** check box, and enter the **Average domain cross section area** A_{domain} (SI unit: m²).
- If the model represents only a part of a geometry obtained from symmetry cuts (for example, a quarter of a circle), use the settings under **Symmetry specification** to specify appropriate correction factors. Enter the **Coil length multiplication factor** F_L and **Coil area multiplication factor** F_A (dimensionless integer numbers). The actual length of the coil, used to compute the coil voltage and resistance, is then computed as the product $F_L \cdot L_{\text{edges}}$. The cross-section area of the coil is computed as $F_A \cdot A_{\text{domain}}$.



- See [Using Coils in 3D Models](#) in the modeling section to learn more about this node.
- [The Magnetic Fields Interface](#)
- [Theory for the Magnetic Fields Interface](#)

User Defined Coil Geometry

The **User Defined Coil Geometry** subnode is available for **Coil** if the **Conductor model** of the parent feature is **Homogenized multi-turn** and the **Coil type** is set to **User defined**.

Specify in this feature an arbitrary vector field that defines the direction of the wires in the coil. Such field can be an analytic expression or can be computed using, for example, a **Curvilinear Coordinates** physics.

For domain features, information on the input/output boundaries is necessary to complete the set up of the coil feature. Use the **Input** and **Output** subfeatures to this node to select the input/output boundaries of the coils, external boundaries where the vector field representing the wire direction has a nonzero normal component. The selection can be left empty if there are no such boundaries, for example in the case of a closed-loop coil. This operation is necessary in time dependent and frequency domain studies if the **Accurate voltage calculation** is active in the parent feature.

COIL GEOMETRY

- Enter the **Coil current flow** \mathbf{e}_{coil} , a vector field representing the local direction of the wires, which can be an analytic expression, or the solution of another physics (for example, [Curvilinear Coordinates](#)). The vector field will be normalized by dividing the local field by the volume average of the field norm. This keeps local variations intact, while scaling the average norm to unity.
- Enter the **Domain length** L_{domain} (for domain features) or the **Boundary length** L_{boundary} (for boundary features). The SI unit is meters. This value should correspond to the average length of the wires in the coil, before any symmetry correction.
- If the model represents only a part of a geometry obtained from symmetry cuts (for example, a quarter of a circle), use the settings under **Symmetry specification** to specify appropriate correction factors. Enter the **Coil length multiplication factor** F_L and **Coil area multiplication factor** F_A (dimensionless integer numbers). The actual length of the coil, used to compute the coil voltage and resistance, is then computed as the product $F_L \cdot L_{\text{domain}}$ (or $F_L \cdot L_{\text{boundary}}$ for boundary features). The cross-section area of the coil is computed as $F_A \cdot A_{\text{domain}}$.

Input (for User Defined Coil Geometry)

The **Input** subnode is added by default as subnode of the [User Defined Coil Geometry](#) node, and is used to provide more information on the coil geometry. Use it to specify the boundaries where the wires (the vector field specified in the parent User Defined Coil Geometry feature) enter the domain. The selection can be left empty in case of a closed-loop coil.

This node should be used in combination with the [Output \(for User Defined Coil Geometry\)](#) node.

Output (for User Defined Coil Geometry)

The **Output** subnode is added by default as subnode of the [User Defined Coil Geometry](#) node and is used to provide more information on the coil geometry. Use it to specify the boundaries where the wires (the vector field specified in the parent User Defined Coil Geometry feature) leave the domain. The selection can be left empty in case of a closed-loop coil.

This node should be used in combination with the [Input \(for User Defined Coil Geometry\)](#) node.

Override Coil Inlet/Outlet

The **Override Coil Inlet/Outlet** subnode is available at the domain level from the context menu (right-click the [Coil](#) parent node) or from the **Physics** toolbar, **Attributes** menu. This is an advanced feature, and is normally not required.

This feature is available if the **Accurate coil voltage calculation** functionality is enabled in the **Stabilization** section of the parent feature. This functionality performs a current filtering to improve the accuracy of the computed electric field and coil voltage in time dependent and frequency domain studies. For this filtering to work properly, special conditions must be defined on the inlet/outlet boundaries, where the wire direction has a nonzero normal component. For **Linear** and **Circular** coils, the geometry analysis algorithm detects automatically these boundaries, but the **Override Coil Inlet/Outlet** feature can be used in case the detection fails. For **Numeric** coils, or when the **Conductor model** is **Single conductor**, the subnodes of the **Geometry Analysis** feature are used to identify the inlets/outlets. For **User defined** coils, the **User Defined Coil Geometry** can be used to select the inlets/outlets instead.



See [Accurate Coil Voltage Calculation](#) in the modeling section to learn more about this node.

Geometry Analysis

In 3D components, when **Conductor model** of the parent feature is **Homogenized multi-turn** and **Numeric** is selected as **Coil type**, or if **Conductor model** of the parent

feature is **Single conductor** in the **Coil** node, the **Geometry Analysis** subnode is added by default. To this, an **Input (for Geometry Analysis)** subnode is also added by default.

This subnode is needed to set up the automatic analysis of the coil geometry that can determine the direction of the wires (and of the current flow). The inlet and outlet boundaries for the wires are specified using the **Input (for Geometry Analysis)** and **Output (for Geometry Analysis)** subnodes.

To complete the setup for the computation of the coil direction, a **Coil Geometry Analysis** study step must be added to the study before the main study step.

If the model represents only a part of a geometry obtained from symmetry cuts (for example, a quarter of a circle), use the settings under **Symmetry specification** to specify appropriate correction factors. Enter the **Coil length multiplication factor** F_L and **Coil area multiplication factor** F_A (dimensionless integer numbers). The actual length of the coil, used to compute the coil voltage and resistance, is then computed as the product $F_L \cdot L$, where L is the length of the domain. The cross-section area of the coil is computed as $F_A \cdot A$, where A is the cross-section area of the domain. The values of L and A are computed automatically during the Coil Geometry Analysis study step.



- [Using Coils in 3D Models](#)
- [Automatic Coil Geometry Analysis](#)
- [The Magnetic Fields Interface](#)
- [Theory for the Magnetic Fields Interface](#)
- [Studies and Solvers](#) in the *COMSOL Multiphysics Reference Manual*

Input (for Geometry Analysis)

The **Input** subnode is added by default as subnode of the **Geometry Analysis** node. Use it to specify the boundaries where the wires enter the domain or, in the case of a closed-loop coil, an interior boundary crossed by the wires. The wire direction is forced to be orthogonal to the boundary. Used in combination with the **Output (for Geometry Analysis)** node, it also defines the direction of the current flow in an open coil (from **Input** to **Output**).

When applied on one or more boundaries, a red arrow in the Graphics window will show the direction of the wire. Select the **Reverse direction** check box to reverse the direction of the wires.



For an open coil, the **Input** subnode should never be added to boundaries that are interior to the coil's domain selection. Note also that an open coil should have its start (**Input**) and end (**Output**) on boundaries that are exterior to the domain selection of the parent physics (for example, **Magnetic Fields**) and of a type that supports closure of the coil by means of an induced surface current density. The latter condition means **Magnetic Insulation** and, in the frequency domain, **Impedance Boundary Condition**.

Output (for Geometry Analysis)

The **Output** subnode is available from the context menu (right-click the **Geometry Analysis** parent node) or from the **Physics** toolbar, **Attributes** menu. Use it to specify the boundaries where the wires exit the domain in an open coil. No **Output** subnode is required in a closed-loop coil. The wire direction is forced to be orthogonal to the boundary. Used in combination with the **Input (for Geometry Analysis)** node, it also defines the direction of the current flow (from **Input** to **Output**).



For an open coil, the **Input** subnode should never be added to boundaries that are interior to the coil's domain selection. Note also that an open coil should have its start (**Input**) and end (**Output**) on boundaries that are exterior to the domain selection of the parent physics (for example, **Magnetic Fields**) and of a type that supports closure of the coil by means of an induced surface current density. The latter condition means **Magnetic Insulation** and, in the frequency domain, **Impedance Boundary Condition**.

CONSTRAINT SETTINGS

To display this section, click the **Show More Options** button () and select **Advanced Physics Options**.



- [Using Coils in 3D Models](#)
- [Automatic Coil Geometry Analysis](#)
- [The Magnetic Fields Interface](#)
- [Theory for the Magnetic Fields Interface](#)
- [Studies and Solvers](#) in the *COMSOL Multiphysics Reference Manual*

Electric Insulation (for Geometry Analysis)

The **Electric Insulation** subnode is available from the context menu (right-click the [Geometry Analysis](#) parent node) or from the **Physics** toolbar, **Attributes** menu. It is particularly useful for interior boundaries (when the coil is compacted, and the turns

touch, see [Figure 5-3](#)). It applies to the coil direction field generated by the **Coil Geometry Analysis** study step.

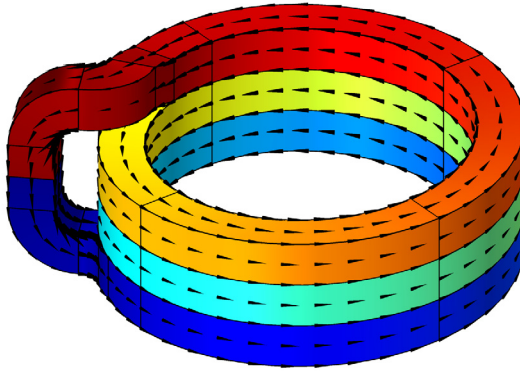

Figure 5-3: A coil geometry with turns that are geometrically unified, yet electrically separated. The electric insulation boundary condition can be used to override the electrical continuity that applies to interior boundaries by default.



- When the **Conductor model** of the **Coil** feature is set to **Single conductor**, the **Electric Insulation** affects the externally applied currents only, not the currents resulting from electromagnetic induction in the model itself. *For this reason, the single conductor with electric insulation should be used in the (quasi) static regime only.*
- When the **Conductor model** of the **Coil** feature is set to **Homogenized multi-turn**, the **Electric Insulation** works for higher frequencies as well, as both external and induced currents are forced along the same path.
- For low frequencies, the **Homogenized multi-turn** option can be considered as an approximation of the **Single conductor** one. For higher frequencies, you should consider having a gap between the turns, or using the **Contact Impedance** boundary feature available in [The Magnetic and Electric Fields Interface](#).

Connected Boundaries

The **Connected Boundaries** subnode is available from the context menu (right-click the **Geometry Analysis** parent node) or from the **Physics** toolbar, **Attributes** menu. It can

be used to mark two or more boundaries as being electrically connected for the purpose of the Coil Geometry Analysis preprocessing step.

The vector field computed in the Coil Geometry Analysis step (which corresponds to the current flow or the wire direction, according to the Conductor model selected) will have zero total flux into the selected boundaries. For example, if two nonconnected boundaries are selected, the feature will enforce the condition that the current entering one boundary must be equal to the current leaving the other boundary.

The feature models an electrical connection between the selected boundaries, and can therefore be used for coils constituted of multiple series-connected domains.



The **Connected Boundaries** functionality enforces current continuity as part of the Coil Geometry Analysis that computes the normalized DC current density. For Frequency Domain and Time Dependent studies the induced current density will not be subject to any restrictions by this functionality. Instead it is recommended to set up the model with one coil per wire segment and enforce current continuity by connecting to [The Electrical Circuit Interface](#). An alternative in the Frequency Domain is to use [The Magnetic and Electric Fields Interface](#) and assign connected boundaries to the same Floating Potential subfeature to Magnetic Insulation.

Single-Turn Coil

The **Single-Turn Coil** node is available both as a domain and as a boundary feature. It models a conductive (for example, metallic) domain or boundary subject to a lumped excitation, such as a total voltage or current. The excitation specified is translated into a conduction current flowing in the domain (as a current density) or the boundary (as a surface current density). The **Single-Turn Coil** *domain* node is a contributing feature, it is applied on top of an [Ampère's Law](#) feature that provides the material model (electrical conductivity and relative permittivity). The *boundary* node is instead exclusive, since the material model is provided in its **Thin Layer** section.

In 2D and 2D axisymmetric components, the Single-Turn Coil feature can be turned into a **Coil group** by selecting the corresponding check box in the **Settings** window.



The **Single-Turn Coil** feature is obsolete in the **Magnetic Field** and **Rotating Machinery, Magnetic** features and will be removed in future versions. The recommended alternative is to use a **Coil** feature with the **Conductor model** set to **Single conductor**.



See **Coil Features** in the modeling section to learn more about using this node.

This node is not available in 3D for **The Magnetic and Electric Fields Interface** and **The Induction Heating Interface**. In 2D and 2D axisymmetric components, the direction of the applied electric field is assumed to be out-of-plane. The settings specify how to compute the electric field and the relative current density.

The approach for 3D components is different than for 2D and 2D axisymmetric components. An additional dependent variable V_{coil} , with the dimension of an electric potential, is defined in the domain and the current continuity equation is added to the system of equations. The problem solved in the domain becomes effectively an A-V formulation of Maxwell's equation and current conservation, similar to the one used in the Magnetic and Electric Fields interface.



For 3D components add boundary conditions for the coil potential. The **Gap Feed** (at the domain level only), **Boundary Feed**, **Ground**, and **Floating Potential** subnodes are available from the context menu (right-click the parent node) or from the **Physics** toolbar, **Attributes** menu. Use these to define the geometry of the coil.

A typical setup is to add a **Gap Feed**, if the coil is closed in a loop, or a **Boundary Feed** and a **Ground**, if the coil is open. In order to avoid unphysical current distribution in the **Boundary Feed** and **Ground** case, the boundary conditions should be applied on external boundaries. The **Gap Feed** subnode is not available for the boundary node for topological reasons.



The 3D Single-Turn Coil is applicable only in Stationary and Frequency Domain studies, since it is a local application of the physical model used in the Magnetic and Electric Fields interface.

THIN LAYER (2D AND 2D AXISYMMETRIC COMPONENTS)

This section is available for 2D and 2D axisymmetric components at the boundary level. Specify here the properties of the material constituting the thin conductive layer.

Select a **Coil conductivity** σ_{coil} (SI unit: S/m) — **From material** (the default) or **User defined**. For **User defined** select **Isotropic**, **Diagonal**, **Symmetric**, or **Full** based on the characteristics of the coil conductivity, and then enter values or expressions in the field or matrix. The default is 1 S/m.

Select a **Coil relative permittivity** $\epsilon_{r,\text{coil}}$ (dimensionless) — **From material** (the default) or **User defined**. For **User defined** select **Isotropic**, **Diagonal**, **Symmetric**, or **Full** based on the characteristics of the coil relative permittivity, and then enter values or expressions in the field or matrix. The default is 1.

Enter the **Thickness** d_s (SI unit: m) of the thin conductive layer. The default is 1 mm.

SINGLE-TURN COIL

3D Components

For 3D components, the parameters **Coil conductivity** and **Coil relative permittivity** define the material model to be used with the current continuity equation. Normally, these parameters should be the same used in the [Ampère's Law](#) feature active in the domain.

Select a **Coil conductivity** σ_{coil} (SI unit: S/m) — **From material** or **User defined**. For **User defined** select **Isotropic**, **Diagonal**, **Symmetric**, or **Full** based on the characteristics of the coil conductivity, and then enter values or expressions in the field or matrix.

Select a **Coil relative permittivity** $\epsilon_{r,\text{coil}}$ (dimensionless) — **From material** or **User defined**. For **User defined** select **Isotropic**, **Diagonal**, **Symmetric**, or **Full** based on the characteristics of the coil relative permittivity, and then enter values or expressions in the field or matrix.

When defining this node on a boundary, also enter a **Thickness** d_s (SI unit: m). The default is 1 mm.

2D and 2D Axisymmetric Components

In 2D and 2D axisymmetric components, the direction of the applied electric field is assumed to be out-of-plane. In these space dimensions, the Coil group check box is available. Select the check box to activate the Coil group functionality.

The settings specifying coil name and excitation are the similar to the ones for the Coil node. See the section [Coil](#) for a description of these settings.

Gap Feed

The **Gap Feed** subnode is available from the context menu (right-click the [Single-Turn Coil](#) parent node) or from the **Physics** toolbar, **Attributes** menu for 3D components (at the domain level). **Gap Feed** is used to excite the coil from an interior boundary. It applies a discontinuity in the coil potential across a boundary to enforce a potential difference or a prescribed current. This feature must be applied to an interior boundary in the coil domain, and is typically used to excite a closed loop.

SINGLE-TURN COIL

See [Single-Turn Coil](#) for all settings.



This node should be used with caution in frequency-domain studies. See [Using Coils in 3D Models](#) in the modeling section to learn more about this node.

CONSTRAINT SETTINGS

To display this section, click the **Show More Options** button () and select **Advanced Physics Options**.

Boundary Feed

The **Boundary Feed** subnode is available from the context menu (right-click the [Single-Turn Coil](#) parent node) or from the **Physics** toolbar, **Attributes** menu for 3D components. The **Boundary Feed** node excites the coil acting on the coil potential variable. The feature must be applied to an external boundary.

SINGLE-TURN COIL

See [Single-Turn Coil](#) for all settings.

CONSTRAINT SETTINGS

To display this section, click the **Show More Options** button () and select **Advanced Physics Options**.



See [Using Coils in 3D Models](#) in the modeling section to learn more about this node.

Ground

The **Ground** subnode is available from the context menu (right-click the [Single-Turn Coil](#) parent node) or from the **Physics** toolbar, **Attributes** menu for 3D components. The **Ground** subnode enforces the condition $V_{\text{coil}} = 0$ on a boundary.

CONSTRAINT SETTINGS

To display this section, click the **Show More Options** button () and select **Advanced Physics Options**.



See [Using Coils in 3D Models](#) in the modeling section to learn more about this node.

Floating Potential

The **Floating Potential** subnode is available from the context menu (right-click the [Single-Turn Coil](#) parent node) or from the **Physics** toolbar, **Attributes** menu. It can be used to model a boundary at a constant, unknown, coil potential. If applied on multiple non connected boundaries, it models an electrical connection between them. The feature can be used for coils constituted of multiple series-connected domains. Unlike the corresponding feature in other AC/DC physics, this feature only allows zero total current flowing in the boundary. This is to ensure that all currents in the coils are excited by the **Boundary Feed** or **Gap Feeds** and are properly accounted for in the postprocessing variables.

CONSTRAINT SETTINGS

To display this section, click the **Show More Options** button () and select **Advanced Physics Options**.

Domain Group/Boundary Group

This feature is available as a subnode of a 2D **Coil** in which the **Coil group** functionality has been activated. This feature is available both for domain and boundary coil features. The **Domain Group/ Boundary Group** subnode is available from the context menu (right-click the parent node) or from the **Physics** toolbar, **Attributes** menu.

The Domain Group/Boundary Group feature is used to group together a number of domains/boundaries for the purposes of the coil set up. The selected domains/boundaries will be considered as one by the coil. Normally, when the **Coil group** check box is selected, each domain/boundary in the parent's selection is considered as series-connected to all the other domains/boundaries.



Coil Groups

Reversed Current Direction

This feature is available as a subnode of a **Coil** or **Single-Turn Coil** in which the **Coil group** functionality has been activated. This feature is available both for domain and boundary coil features. The **Reversed Current Direction** subnode is available from the context menu (right-click the parent node) or from the **Physics** toolbar, **Attributes** menu.

Use this subnode to mark domains or boundaries in which the coil current flows in a reversed direction, that is antiparallel to the out-of-plane direction (z or azimuthal direction). This subnode can be used in any combination with the **Domain Group/Boundary Group** subnode.



Coil Groups

Lumped Port

Use the **Lumped Port** condition to apply a uniform electric field between two metallic boundaries. The excitation at the port can be expressed as a voltage or as a current, or via the connection to a circuit interface. The use of this feature is justified in frequency-domain studies when the distance between the metallic boundaries is much

smaller than the wavelength of the electromagnetic radiation. Subject to the same requirements it can also be used in the time domain as a convenient way to excite a model.



See [S-Parameters and Ports](#) and [Lumped Ports with Voltage Input](#) for more information.

The geometry of the port is specified by the **Type of port**. A **Uniform** lumped port applies a constant electric field between the metallic electrodes. A **Coaxial** lumped port applies a radial electric field between two concentric circular metallic boundaries. For these two cases, the dimension of the port is computed automatically by analyzing the geometry. Generally, select **User defined** to manually specify the direction between the lumped port terminals \mathbf{a}_h and the dimensions of the port: h_{port} (**Height of lumped port**) and w_{port} (**Width of lumped port**), both with SI unit: m.



For 2D components, a **Uniform** port applies an in-plane electric field. Therefore, the **Uniform** value is available for the **Port type** parameter only if the in-plane vector potential is solved for, according to the settings in the physics interface node. If the **Components** selected are **Out-of-plane vector potential**, the **Uniform** lumped port is not available.



For 2D axisymmetric components, the radial direction is in-plane with respect to the geometry. Therefore, the **Coaxial** value is available for the **Port type** parameter only if the in-plane vector potential is solved for, according to the settings in the physics interface node. If the **Components** selected are **Out-of-plane vector potential**, the **Coaxial** lumped port is not available.



For 2D and 2D axisymmetric components, if the **Components** selected in the physics interface is **Out-of-plane vector potential**, the dimension of the port cannot be obtained by analyzing the geometry and must be specified manually by the user. Therefore, **User defined** is the only option available for the **Port type** parameter. For this case the **Direction between lumped port terminals** is assumed to be in the out-of-plane direction and the input field is not available.

PORT PROPERTIES

Enter a unique **Port name**. It is recommended to use a numeric name as it is used to define the elements of the S-parameter matrix and numeric port names are also required for port sweeps and Touchstone file export.

Type of Port

The geometry of the port is specified by the **Type of port**. A **Uniform** lumped port applies a constant electric field between the metallic electrodes. A **Coaxial** lumped port applies a radial electric field between two concentric circular metallic boundaries. For these two cases, the dimension of the port is computed automatically by analyzing the geometry.



Select a **Type of port** — **Uniform**, **Coaxial**, or **User defined**.



The **Type of port** options available depend on the **Components** selected on the physics interface — **Out-of-plane vector potential** (the default), **In-plane vector potential**, or **Three-component vector potential**.

- For **Out-of-plane vector potential** the **Type of port** is **User defined**.
- For **In-plane vector potential** or **Three-component vector potential** select a **Type of port** — **Uniform** or **User defined**.



The **Type of port** options available depend on the **Components** selected on the physics interface — **Out-of-plane vector potential** (the default), **In-plane vector potential**, or **Three-component vector potential**.

- For **Out-of-plane vector potential** the **Type of port** is **User defined**.
- For **In-plane vector potential** or **Three-component vector potential** select a **Type of port** — **Coaxial** or **User defined**.

Select **User defined** for non uniform ports, for example, a curved port and enter values or expressions in the fields for these additional settings:

- **Height of lumped port** h_{port} (SI unit: m)
- **Width of lumped port** w_{port} (SI unit: m)
- A three-dimensional vector specifying the **Direction between lumped port terminals** \mathbf{a}_h (the direction of the applied electric field)

Type

For all **Types of ports**, select a **Terminal type** — **Cable** for a voltage driven transmission line, **Current** for a current driven port, or **Circuit**.

Wave Excitation at this Port



This section is available if **Cable** is selected as the **Terminal type**.

Select **On** or **Off** from the **Wave excitation at this port** list to set whether it is an inport or a listener port (connected to a passive transmission line). For **On** enter a **Voltage** V_0 (SI unit: V), and **Port phase** θ (SI unit: rad).

The section is deactivated if a Port sweep is active, since in this case the sweep controls the ports.



For the purpose of computing S-parameters, only one port at the time should be excited, for example by performing a Port sweep. In other cases, for example, when studying microwave heating, more than one inport might be desired, but in this case the S-parameter variables cannot be correctly computed. If several ports are excited at the same time, the S-parameter variables are not available for postprocessing.

SETTINGS



This section is available if **Cable** or **Current** is selected as the **Terminal type**.

- For **Cable** enter the **Characteristic impedance** Z_{ref} (SI unit: Ω).
- For **Current** enter a **current** I_0 (SI unit: A).

Lumped Element

Use a **Lumped Element** node to mimic the insertion of a resistor, capacitor, inductor or general impedance between two metallic boundaries. It is similar to the [Lumped Port](#) but does not allow for an excitation and does not generate S-parameter output.

LUMPED ELEMENT PROPERTIES

Enter a unique **Lumped element name**. See [Lumped Port](#) for the rest of the settings.

SETTINGS

Select a **Lumped element type** — **User defined** (the default), **Inductor**, or **Capacitor**.

- For **User defined** enter a **Lumped element impedance** Z_{element} (SI unit: Ω ; default 50 Ω .)
- For **Inductor** enter a **Lumped element inductance** L_{element} (SI unit: H; default 1 nH).
- For **Capacitor** enter a **Lumped element capacitance** C_{element} (SI unit: F; default 1 pF).

Edge Current

Use the **Edge Current** node to specify a line current along one or more edges. A positive edge current flows in the direction marked by the red arrow.

Add a contribution as a **Harmonic Perturbation** by right-clicking the parent node or click **Harmonic Perturbation** on the **Physics** toolbar. For more information see [Harmonic Perturbation — Exclusive and Contributing Nodes](#) in the *COMSOL Multiphysics Reference Manual*.

EDGE CURRENT

Specify the **Edge current** I_0 (SI unit: A). The default is 0 A.

External Magnetic Vector Potential



This node is only available when solving a problem with a background magnetic vector potential (**Reduced field** is selected from the **Solve for** list under **Background Field** on the physics interface **Settings** window).

The **External Magnetic Vector Potential** boundary condition forces the reduced magnetic vector potential to be zero on the boundary, or, equivalently, forces the total field to be equal to the background field. Apply this boundary condition on external boundaries that are at a distance far enough from the system so that its effect on the background field is negligible.

Impedance Boundary Condition

The **Impedance Boundary Condition** provides a boundary condition that is useful at boundaries where the electromagnetic field penetrates only a short distance outside the boundary.

$$\sqrt{\frac{\mu_0 \mu_r}{\epsilon_0 \epsilon_r - j\sigma/\omega}} \mathbf{n} \times \mathbf{H} + \mathbf{E} - (\mathbf{n} \cdot \mathbf{E}) \mathbf{n} = (\mathbf{n} \cdot \mathbf{E}_s) \mathbf{n} - \mathbf{E}_s$$

The boundary condition approximates this penetration to avoid the need to include another domain in the model. The material properties that appear in the equation are those for the conductive material excluded from the model.

The skin depth (that is, the distance where the electromagnetic field has decreased by a factor e^{-1}) is for a good conductor

$$\delta = \sqrt{\frac{2}{\omega \mu \sigma}}$$

The impedance boundary condition is a valid approximation if the skin depth is small compared to the size of the conductor. The source electric field \mathbf{E}_s can be used to specify a source surface current on the boundary.

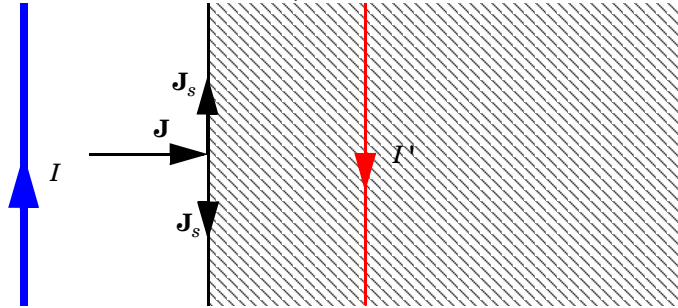

The impedance boundary condition is used on exterior boundaries representing the surface of a lossy domain. The shaded (lossy) region is not part of the model. The effective induced image currents are of reduced magnitude due to losses. Any current flowing into the boundary is perfectly balanced by induced surface currents as for the perfect electric conductor boundary condition. The tangential electric field is generally small but nonzero at the boundary.

The **Harmonic Perturbation** subnode (it is of the exclusive type) is available from the context menu (right-click the parent node) or on the **Physics** toolbar, click the **Attributes** menu and select **Harmonic Perturbation**. For more information see [Harmonic Perturbation — Exclusive and Contributing Nodes](#) in the *COMSOL Multiphysics Reference Manual*.

Use it to specify a perturbation source electric field.

IMPEDANCE BOUNDARY CONDITION

The following material properties can be defined for the domain outside the boundary, which this boundary condition approximates. The default use the values **From material**. For **User defined** enter different values or expressions.

- **Relative permittivity**, ϵ_r (dimensionless)
- **Relative permeability**, μ_r (dimensionless)
- **Electrical conductivity**, σ (SI unit: S/m)

Based on space dimension, enter coordinate values or expressions for the **Source electric field** \mathbf{E}_s (SI unit: V/m).

Transition Boundary Condition



This node is available with the Frequency Domain study type.

The **Transition Boundary Condition** is used on interior boundaries to model a sheet of a highly conducting medium with a thickness relatively smaller than the characteristic size, and curvature, of the objects being modeled. It can be used even if the thickness is many times greater than the skin depth. Accounting for the material properties as well as the thickness of the sheet, transfer and surface impedances are used to relate the current flowing on the surface of either side to the discontinuity in the tangential electric field. Mathematically it is described by a relation between the electric field discontinuity and the induced surface current density:

$$\mathbf{J}_{s1} = \frac{(Z_S \mathbf{E}_{t1} - Z_T \mathbf{E}_{t2})}{Z_S^2 - Z_T^2}$$

$$\mathbf{J}_{s2} = \frac{(Z_S \mathbf{E}_{t2} - Z_T \mathbf{E}_{t1})}{Z_S^2 - Z_T^2}$$

$$Z_S = \frac{-j\omega\mu}{k} \frac{1}{\tan(kd)}$$

$$Z_T = \frac{-j\omega\mu}{k} \frac{1}{\sin(kd)}$$

$$k = \omega\sqrt{(\epsilon + (\sigma/(j\omega)))\mu}$$

Where indices 1 and 2 refer to the different sides of the layer.

TRANSITION BOUNDARY CONDITION

The **Transition Boundary Condition** section has the following material properties for the thin layer, which this boundary condition approximates:

The defaults use the values **From material**, taking the properties from the material specified for the boundary. For **User defined**, enter different values or expressions.

- **Relative permittivity**, ϵ_r (dimensionless)
- **Relative permeability**, μ_r (dimensionless)
- **Electrical conductivity**, σ (SI unit: S/m)
- **Surface thickness**, d_s (SI unit: m)

Thin Low Permeability Gap

Use the **Thin Low Permeability Gap** boundary condition to model gaps in magnetic materials filled with another material with smaller relative permeability. This feature applies the condition

$$\mathbf{n} \times (\mathbf{H}_1 - \mathbf{H}_2) = \nabla_t \times \frac{d}{\mu_0 \mu_r} \nabla_t \times \mathbf{A}$$

This boundary condition is only applicable on interior boundaries and pair boundaries. Use this boundary condition to model, for example, air gaps in magnetic circuits.

THIN LOW PERMEABILITY GAP

The default **Relative permeability** μ_r (dimensionless) is taken **From material**. For **User defined** select **Isotropic**, **Diagonal**, **Symmetric**, or **Full** based on the characteristics of the relative permeability, and then enter a value or expression in the field or matrix.

Enter a **Surface thickness** d_s (SI unit: m) for the gap. The default is 1 m.

Magnetic Point Dipole

Apply a **Magnetic Point Dipole** \mathbf{M} (SI unit: $\text{m}^2 \cdot \text{A}$) to points. This represents the limiting case of when the cross-section area a of a circular current loop carrying uniform current I approaches zero while maintaining the product between I and a finite. The dipole moment is a vector entity with the positive direction set by the curl of the current. Magnetic point dipoles are available with 2D and 3D components. See [Magnetic Point Dipole \(on Axis\)](#) for the 2D axisymmetric settings.

DIPOLE SPECIFICATION

Select a **Dipole specification** — **Magnitude and direction** or **Dipole moment**.

DIPOLE PARAMETERS

If **Magnitude and direction** is selected under **Dipole Specification**, enter coordinates for the **Magnetic dipole moment direction** \mathbf{n}_m and the **Magnetic dipole moment, magnitude** m (SI unit: $\text{m}^2 \cdot \text{A}$).

If **Dipole moment** is selected under **Dipole Specification**, enter coordinates for the **Magnetic dipole moment** \mathbf{m} (SI unit: $\text{m}^2 \cdot \text{A}$).

Magnetic Point Dipole (on Axis)

Use the **Magnetic Point Dipole (on Axis)** to apply a point dipole to points on a 2D axisymmetric component. See [Magnetic Point Dipole](#) for settings for 2D and 3D components.

MAGNETIC POINT DIPOLE (ON AXIS)

Enter a **Magnetic dipole moment in z direction** m_z (SI unit: $\text{m}^2 \cdot \text{A}$).

Magnetic Shielding

The **Magnetic Shielding** node adds a boundary condition for magnetic shielding. It describes a thin layer of a highly permeable medium that shields the magnetic field. Because of the presence of this thin layer, the tangential components of the magnetic field and vector potential have discontinuities given by:

$$\mathbf{n} \times (\mathbf{H}_1 - \mathbf{H}_2) = \mathbf{n} \times \mathbf{H}_t(\mathbf{B}_t)$$
$$\mathbf{B}_t = \mathbf{n} \times \left(\frac{\mathbf{A}_1 - \mathbf{A}_2}{d_s} \right)$$

In this equation, d_s is the surface layer thickness and the relation between the tangential magnetic field \mathbf{H}_t and flux density \mathbf{B}_t inside the layer can be linear and given by a relative permeability or nonlinear and given by the H-B curve of the layer material.



The Magnetic Shielding model uses a magnetostatic approach and can only be used in a **Stationary** study step. For a frequency-domain model of a similar physical object (thin layer) use the [Transition Boundary Condition](#) node instead.

MAGNETIC SHIELDING

Enter a value or expression for the **Surface thickness** d_s (SI unit: m).

Relative Permeability

Select **Relative permeability** μ_r (dimensionless) to use the constitutive relation

$\mathbf{B} = \mu_0 \mu_r \mathbf{H}$. The default uses values **From material**. For **User defined** enter another value or expression.

H-B Curve

Select **H-B curve** $|\mathbf{H}|$ (SI unit: A/m) to use a curve that relates magnetic flux density \mathbf{B} and the magnetic field \mathbf{H} as $|\mathbf{H}| = f(|\mathbf{B}|)$. The **Magnetic field norm** setting can take the values **From material** or **User defined**.

The Magnetic Field Formulation Interface

The **Magnetic Field Formulation (mfh)** interface (), found under the **AC/DC>Electromagnetic Fields>Vector Formulations** branch when adding a physics interface, is used to compute magnetic fields and induced current distributions. It is especially suitable for time-domain magnetic modeling of materials with a strongly nonlinear E-J characteristic such as superconductors. Stationary, frequency-domain, small-signal analysis and time-domain modeling are supported in 2D and 3D. Note that the formulation requires a nonzero conductivity everywhere.

The physics interface solves Maxwell's equations formulated using the magnetic field as the dependent variable.

The main node is [Faraday's Law](#), which adds the equation for the magnetic field and provides an interface for defining the constitutive relations and its associated properties such as the relative permeability.

When this physics interface is added, these default nodes are also added to the **Model Builder** — **Magnetic Field Formulation**, **Faraday's Law**, **Magnetic Insulation** (the default boundary condition), **Initial Values**, and **Magnetic Gauss' Law**. Then, from the **Physics** toolbar, add other nodes that implement, for example, boundary conditions and external currents. You can also right-click **Magnetic Field Formulation** to select physics features from the context menu.

Physics-Controlled Mesh

The physics-controlled mesh is controlled from the **Mesh** node's **Settings** window (if the **Sequence type** is **Physics-controlled mesh**). There, in the table in the **Physics-Controlled Mesh** section, find the physics interface in the **Contributor** column and select or clear the check box in the **Use** column on the same table row for enabling (the default) or disabling contributions from the physics interface to the physics-controlled mesh.

Information from the physics, such as the presence of an infinite elements domain, will be used to automatically set up an appropriate mesh sequence.



In the *COMSOL Multiphysics Reference Manual* see the [Physics-Controlled Mesh](#) section for more information about how to define the physics-controlled mesh.

SETTINGS

The **Label** is the default physics interface name.

The **Name** is used primarily as a scope prefix for variables defined by the physics interface. Refer to such physics interface variables in expressions using the pattern `<name>.<variable_name>`. In order to distinguish between variables belonging to different physics interfaces, the `name` string must be unique. Only letters, numbers, and underscores (`_`) are permitted in the **Name** field. The first character must be a letter.

The default **Name** (for the first physics interface in the model) is `mfh`.

COMPONENTS



This section is only available in 2D and 2D axially symmetric components.

The electric currents and the electric field vectors are orthogonal to the magnetic field. This setting also controls the direction in which applied and induced currents can flow in the model. The default option is to solve for the in-plane components only, allowing an out-of-plane current flow.

Select **Components** — **Out-of-plane magnetic field**, **In-plane magnetic field** (the default), or **Three-component magnetic field** for the magnetic field. This choice affect also the directions in which the electric current is allowed to flow: the magnetic field and electric currents are orthogonal.

When **In-plane magnetic field** or **Three-component magnetic field** is selected, the [Magnetic Gauss' Law](#) node becomes available, and is added as default.

DEPENDENT VARIABLES

The dependent variable is the **Magnetic field \mathbf{H}** . You can change both its field name and the individual component variable names. If the new field name coincides with the name of another magnetic vector potential field in the model, the interfaces share degrees of freedom and component names. The new field name must not coincide with the name of a field of another type or with a component name belonging to some other field. Component names must be unique within a model, except for fields of the same type sharing a common field name.

DIVERGENCE CONSTRAINT

To display this section, click the **Show More Options** button () and select **Advanced Physics Options**.

The **Activate divergence constraint** check box is selected by default, which enables the default [Magnetic Gauss' Law](#) node. Click to clear the check box to disable the Magnetic Gauss's Law node and remove it from the physics interface.

ERROR CHECK

To display this section, click the **Show More Options** button () and select **Advanced Physics Options**.

When the **Check applicability of features in study** check box is selected, any features that are incompatible with the study will generate an error message when trying to solve or show the default solver. No solver will be generated. Deselect it and you will be able to run the model, possibly with runtime errors instead. It is available to allow the advanced user to tweak any feature and use it outside of its intended study scope.

DISCRETIZATION



- [Domain, Boundary, Point, and Pair Nodes for the Magnetic Field Formulation Interface](#)
- [Theory for the Magnetic Field Formulation Interface](#)



Superconducting Wire: Application Library path
ACDC_Module/Other_Industrial_Applications/superconducting_wire

Domain, Boundary, Point, and Pair Nodes for the Magnetic Field Formulation Interface

The [Magnetic Field Formulation Interface](#) has these domain, boundary, point, and pair nodes available from the **Physics** ribbon toolbar (Windows users), **Physics** context menu (Mac or Linux users), or right-click to access the context menu (all users).



In general, to add a node, go to the **Physics** toolbar, no matter what operating system you are using. Subnodes are available by clicking the parent node and selecting it from the **Attributes** menu.

About the Boundary Conditions

With no surface currents present the physics interface conditions

$$\mathbf{n}_2 \times (\mathbf{H}_1 - \mathbf{H}_2) = \mathbf{0}$$

need to be fulfilled. Because \mathbf{H} is being solved for, the tangential component of the magnetic field is always continuous, and thus the condition is automatically fulfilled.

Table 5-2 lists the interior and exterior boundary conditions available with this physics interface.

TABLE 5-2: INTERIOR AND EXTERIOR BOUNDARY CONDITIONS FOR THE MAGNETIC FIELD FORMULATION INTERFACE

NODE	INTERIOR	EXTERIOR
Electric Field	x	x
Impedance Boundary Condition		x
Magnetic Field	x	x
Magnetic Insulation	x	x
Perfect Magnetic Conductor	x	x
Surface Magnetic Current Density	x	x

Available Nodes

These nodes are available for this physics interface and listed in alphabetical order. Also see Table 5-2 for the list of interior and exterior boundary conditions.

- Electric Field
- Faraday's Law
- Initial Values
- Magnetic Gauss' Law
- Magnetic Insulation
- Surface Magnetic Current Density

These nodes are described for the Magnetic Fields or Electrostatics interface (listed in alphabetical order):

- External Current Density
- Force Calculation
- Impedance Boundary Condition
- Magnetic Field
- Perfect Magnetic Conductor
- Velocity (Lorentz Term)



For 2D axisymmetric components, COMSOL Multiphysics takes the axial symmetry boundaries (at $r = 0$) into account and automatically adds an **Axial Symmetry** node to the component that is valid on the axial symmetry boundaries only.



In the *COMSOL Multiphysics Reference Manual* see [Table 2-4](#) for links to common sections and [Table 2-5](#) to common feature nodes. You can also search for information: press F1 to open the **Help** window or Ctrl+F1 to open the **Documentation** window.

Faraday's Law

The **Faraday's Law** node adds Faraday's law for the electric field and provides an interface for defining the constitutive relation and its associated properties such as the relative permeability as well as electric properties.

Except for two extra options; **Resistivity** and **E-J characteristic**, in the **Constitutive Relation Jc-E** settings, and the important notes listed below, see [Ampère's Law](#) for the rest of the settings.



If **E-J characteristic** is selected in the **Conduction Current** settings, the [External Current Density](#) node cannot be used to drive currents in that domain selection.



In order to obtain a closed system of equations with this physics interface, the **Electrical conductivity** (defined under **Conduction Current**) must be nonzero in all domains.

Initial Values

The **Initial Values** node adds an initial value for the magnetic field **H** that can serve as an initial value for a transient simulation or as an initial guess for a nonlinear solver.

INITIAL VALUES

Enter values or expressions for the **Magnetic field H** (SI unit: A/m) components. The defaults are 0 A/m.

Magnetic Gauss' Law

The **Magnetic Gauss' Law** node is used to impose the condition

$$\nabla \cdot \mathbf{B} = 0$$

on the magnetic flux density by introducing an auxiliary dependent variable ψ with the corresponding equation.

MAGNETIC GAUSS' LAW

The variable ψ is used to impose a condition on the derivatives of the magnetic flux density, so its absolute value does not have particular significance; only its gradient enters the equations (the variable ψ acts more or less like a potential). The absolute value of the variable can be set by entering the Enter a value or expression for the **Divergence condition variable scaling** Ψ_0 (SI unit: A). The default is 1 A, which is appropriate in most cases.

ADVANCED SETTINGS

To display this section, click the **Show More Options** button () and select **Advanced Physics Options**.

This section allows a more fine control on the boundary conditions for ψ applied by the **Magnetic Gauss' Law** feature. The domain equation for ψ only imposes a condition on the gradient, so it is important to constrain the absolute value of ψ to ensure a nonsingular model. Select the **Constrain variable in at least one point** to ensure that there is always a constraint set on the value of the divergence condition variable ψ . The feature also sets up automatically the appropriate boundary conditions for ψ . Use the **Method** combo box to select the approach used to enforce the boundary condition: **Constrain value** (the default) or **Constrain tangential gradient**.

Magnetic Insulation

The **Magnetic Insulation** node is the default boundary condition for the Magnetic Field Formulation interface. In this formulation, this condition corresponds to setting the tangential components of the electric field to zero at the boundary $\mathbf{n} \times \mathbf{E} = 0$.



For more information and the settings, see [Magnetic Insulation](#) as described for the Magnetic Fields interface.

Electric Field

The **Electric Field** boundary condition

$$\mathbf{n} \times \mathbf{E} = \mathbf{n} \times \mathbf{E}_0$$

specifies the tangential component of the electric field. This feature can be used to specify a source electric field on the boundary of the conductor.

The **Harmonic Perturbation** subnode (it is of the exclusive type) is available from the context menu (right-click the parent node) or on the **Physics** toolbar, click the **Attributes** menu and select **Harmonic Perturbation**. For more information see [Harmonic Perturbation — Exclusive and Contributing Nodes](#) in the *COMSOL Multiphysics Reference Manual*.

ELECTRIC FIELD

Enter the value or expression for the components of the **Electric field** \mathbf{E}_0 (SI unit: V/m). The defaults are 0 V/m.

Surface Magnetic Current Density

The **Surface Magnetic Current Density** node adds a boundary condition for a surface magnetic current density \mathbf{J}_{ms} (a flow of magnetic charges along a boundary):

$$\begin{aligned} -\mathbf{n} \times \mathbf{E} &= \mathbf{J}_{ms} \\ \mathbf{n} \times (\mathbf{E}_1 - \mathbf{E}_2) &= \mathbf{J}_{ms} \end{aligned}$$

These expressions apply to exterior and interior boundaries, respectively. On exterior boundaries, the condition is equivalent to an Electric field boundary condition where the electric field is specified as $\mathbf{J}_{ms} \times \mathbf{n}$.

Add a contribution as a **Harmonic Perturbation** by right-clicking the parent node or click **Harmonic Perturbation** on the **Physics** toolbar. For more information see [Harmonic Perturbation — Exclusive and Contributing Nodes](#) in the *COMSOL Multiphysics Reference Manual*.

SURFACE MAGNETIC CURRENT DENSITY

Enter values or expressions for the **Surface magnetic current density** $\mathbf{J}_{ms,0}$ (SI unit V/m) coordinates. The defaults are 0 V/m.

The Magnetic Fields, No Currents Interface

The **Magnetic Fields, No Currents (mfnc)** interface () , found under the **AC/DC>Magnetic Fields, No Currents** branch when adding a physics interface, is used to compute magnetostatic fields from permanent magnets and other current free magnetic sources. The formulation is stationary but for use together with other physics also time-domain modeling is supported in 2D and 3D.

The physics interface solves Gauss' Law for the magnetic field using the scalar magnetic potential as the dependent variable.

The main node is the [Magnetic Flux Conservation](#) feature, which adds the equation for the magnetic potential and provides an interface for defining the material properties and the constitutive relation for the magnetic flux density. It is used when there are no currents and all the magnetic fields are originated by permanent magnets or external systems not included in the model.

When this physics interface is added, these default nodes are also added to the **Model Builder** — **Magnetic Fields, No Currents, Magnetic Flux Conservation, Magnetic Insulation** (the default boundary condition), and **Initial Values**. Then, from the **Physics** toolbar, add other nodes that implement, for example, additional boundary conditions and point conditions. You can also right-click **Magnetic Fields, No Currents** to select physics features from the context menu.

Physics-Controlled Mesh

The physics-controlled mesh is controlled from the **Mesh** node's **Settings** window (if the **Sequence type** is **Physics-controlled mesh**). There, in the table in the **Physics-Controlled Mesh** section, find the physics interface in the **Contributor** column and select or clear the check box in the **Use** column on the same table row for enabling (the default) or disabling contributions from the physics interface to the physics-controlled mesh.

Information from the physics, such as the presence of an infinite elements domain or periodic condition, will be used to automatically set up an appropriate mesh sequence.



In the *COMSOL Multiphysics Reference Manual* see the [Physics-Controlled Mesh](#) section for more information about how to define the physics-controlled mesh.



Except where described below, the **Settings** windows are described for the Magnetic Fields and Electrostatics interfaces.

SETTINGS

The **Label** is the default physics interface name.

The **Name** is used primarily as a scope prefix for variables defined by the physics interface. Refer to such physics interface variables in expressions using the pattern `<name>.<variable_name>`. In order to distinguish between variables belonging to different physics interfaces, the `name` string must be unique. Only letters, numbers, and underscores (`_`) are permitted in the **Name** field. The first character must be a letter.

The default **Name** (for the first physics interface in the model) is `mfnc`.

BACKGROUND MAGNETIC FIELD

Select an option from the **Solve for** list — **Reduced field** or **Full field** (the default). For **Reduced field** specify a **Background magnetic field** \mathbf{H}_b (SI unit: A/m). The entered expressions must be differentiable.



Notice that expressions including coupling operators are not differentiable and cannot be used as background fields.

When a background field is active, the physics interface solves for the reduced (perturbation) field only. This setting, together with the External Magnetic Flux Density feature, is useful to introduce an external field generated by systems not included in the model.

THICKNESS



Enter a value or expression for the **Out-of-plane thickness** d . The default value of 1 unit length is typically not representative for a thin domain. Instead it describes a unit thickness that makes the 2D equation identical to the equation used for 3D components.

ERROR CHECK



To display this section, click the **Show More Options** button () and select **Advanced Physics Options**.

When the **Check applicability of features in study** check box is selected, any features that are incompatible with the study will generate an error message when trying to solve or show the default solver. No solver will be generated. Deselect it and you will be able to run the model, possibly with runtime errors instead. It is available to allow the advanced user to tweak any feature and use it outside of its intended study scope.

DEPENDENT VARIABLES

The dependent variable (field variable) is for the **Magnetic scalar potential V_m** . The name can be changed but the names of fields and dependent variables must be unique within a model.

DISCRETIZATION

	<ul style="list-style-type: none"> • Domain, Boundary, Point, and Pair Nodes for the Magnetic Fields, No Currents Interface • Theory for the Magnetic Fields, No Currents Interface
	<ul style="list-style-type: none"> • <i>Magnetic Prospecting of Iron Ore Deposits</i>: Application Library path ACDC_Module/Magnetostatics/magnetic_prospecting • <i>Magnetic Signature of a Submarine</i>: Application Library path ACDC_Module/Magnetostatics/submarine

Domain, Boundary, Point, and Pair Nodes for the Magnetic Fields, No Currents Interface

The [Magnetic Fields, No Currents Interface](#) has these domain, boundary, point, and pair nodes available from the **Physics** ribbon toolbar (Windows users), **Physics** context menu (Mac or Linux users), or right-click to access the context menu (all users).

	<p>In general, to add a node, go to the Physics toolbar, no matter what operating system you are using. Subnodes are available by clicking the parent node and selecting it from the Attributes menu.</p>
---	---



To obtain a unique solution, the value of the magnetic potential must be provided at least at one point. If the magnetic insulation boundary condition is used everywhere, the potential has to be fixed using a point condition.

ABOUT THE BOUNDARY CONDITIONS

In magnetostatics the relevant physics interface condition between two domains 1 and 2 is

$$\mathbf{n}_2 \cdot (\mathbf{B}_1 - \mathbf{B}_2) = 0$$

This condition provides continuity of the normal component of the magnetic flux density and is automatically satisfied by the natural boundary condition for interior boundaries, which is

$$\mathbf{n} \cdot [(\mu_0 \nabla V_m - \mathbf{M})_1 - (\mu_0 \nabla V_m - \mathbf{M})_2] = -\mathbf{n} \cdot (\mathbf{B}_1 - \mathbf{B}_2) = 0$$

AVAILABLE NODES

These nodes are available for this physics interface and listed in alphabetical order. Also see [Table 5-3](#) for a list of interior and exterior boundary conditions.

- [External Magnetic Flux Density](#)
- [Initial Values](#)
- [Force Calculation](#)¹
- [Magnetic Flux Conservation](#)
- [Magnetic Flux Density](#)
- [Magnetic Insulation](#)
- [Magnetic Scalar Potential](#)
- [Magnetic Shielding](#)
- [Periodic Condition](#)
- [Sector Symmetry](#)¹
- [Thin Low Permeability Gap](#)
- [Zero Magnetic Scalar Potential](#)

¹ Described for another physics interface in this user guide.



- [Infinite Elements, Perfectly Matched Layers, and Absorbing Layers in the *COMSOL Multiphysics Reference Manual*](#)

Table 5-3 lists the interior and exterior boundary conditions available with this physics interface.

TABLE 5-3: INTERIOR AND EXTERIOR BOUNDARY CONDITIONS FOR THE MAGNETIC FIELDS, NO CURRENTS INTERFACE

PHYSICS NODE	INTERIOR	EXTERIOR
External Magnetic Flux Density		x
Magnetic Flux Density		x
Magnetic Insulation	x	x
Magnetic Scalar Potential	x	x
Magnetic Shielding	x	x
Periodic Condition		x
Thin Low Permeability Gap	x	
Zero Magnetic Scalar Potential	x	x

Magnetic Flux Conservation

The **Magnetic Flux Conservation** node adds Equation 5-5 above (or a similar equation depending on the selected constitutive relation) for the magnetic potential and provides an interface for defining the constitutive relation and the relevant material properties (for example, the relative permeability).

MATERIAL TYPE

The **Material type** setting decides how materials behave and how material properties are interpreted when the mesh is deformed. Select **Solid** for materials whose properties change as functions of material strain, material orientation and other variables evaluated in a material reference configuration (material frame). Select **Nonsolid** for materials whose properties are defined only as functions of the current local state at each point in the spatial frame, and for which no unique material reference configuration can be defined. Select **From material** to pick up the corresponding setting from the domain material on each domain.

CONSTITUTIVE RELATION B-H



See the settings for Constitutive Relation B-H under [Ampère's Law](#), except for these differences:

- **Magnetic losses** and **Effective B-H curve**, being time-harmonic material models, are not available.
- Select **B-H curve** to use a curve that relates magnetic flux density **B** and the magnetic field **H** as $|\mathbf{B}| = f(|\mathbf{H}|)$. To define $|\mathbf{B}|$, select **From material** (the default) to use the value from the material or select **User defined** to specify a value or expression for the magnitude of the magnetic flux density in the field that appears.

Initial Values

The **Initial Values** node adds an initial value for the magnetic scalar potential that can serve as an initial guess for a nonlinear solver.

INITIAL VALUES

Enter a value or expression for the initial value of the **Magnetic scalar potential** V_m . The default value is 0 A.

Magnetic Insulation

The **Magnetic Insulation** node for the Magnetic Fields, No Currents interface provides magnetic insulation using the following boundary condition, which sets the normal component of the magnetic flux density to zero $\mathbf{n} \cdot \mathbf{B} = 0$. Magnetic insulation is the default boundary condition.



This condition is useful at boundaries confining a surrounding region of air or to model symmetry cuts.

Magnetic Scalar Potential

The **Magnetic Scalar Potential** node adds a boundary condition for the magnetic scalar potential:

$$V_m = V_{m0}$$

MAGNETIC SCALAR POTENTIAL

Enter a value or expression for the **Magnetic scalar potential** V_{m0} (SI unit: A). The default is 0 A.

CONSTRAINT SETTINGS

To display this section, click the **Show More Options** button () and select **Advanced Physics Options**.

Magnetic Flux Density

The **Magnetic Flux Density** node adds a boundary condition for the magnetic flux density. The following equation defines the normal component of the magnetic flux density using a magnetic flux vector \mathbf{B}_0 :

$$\mathbf{n} \cdot \mathbf{B} = \mathbf{n} \cdot \mathbf{B}_0 \quad (5-1)$$

Using this boundary condition specify the normal component of the magnetic flux density at the boundary.

Alternatively, specify an inward (or outward) flux density using the following equation:

$$-\mathbf{n} \cdot \mathbf{B} = B_n \quad (5-2)$$

Using this formulation, it is possible to specify the normal component of the magnetic flux density as a scalar.

MAGNETIC FLUX DENSITY

Select a **Type** of the boundary condition to use — **Inward flux density** (the default) or **Magnetic Flux density**:

- For **Inward flux density** it defines the boundary condition according to [Equation 5-2](#). Enter a scalar value or expression for the normal component of the **Inward flux density** B_n (SI unit: T). A positive value represents an inward flux.
- For **Magnetic flux density** it defines the boundary condition according to [Equation 5-1](#). Enter a value or expression for each component of the **Magnetic flux density** \mathbf{B}_0 (SI unit: T) in the corresponding fields.

Zero Magnetic Scalar Potential

The **Zero Magnetic Scalar Potential** node provides a boundary condition that specifies a zero magnetic potential on the boundary $V_m = 0$.

CONSTRAINT SETTINGS

To display this section, click the **Show More Options** button () and select **Advanced Physics Options**.

External Magnetic Flux Density



This node is only available when solving a problem with a background magnetic flux density (**Reduced field** is selected from the **Solve for** list under **Background Field** on the physics interface **Settings** window).

The **External Magnetic Flux Density** boundary condition forces the reduced magnetic flux density to be zero on the boundary, or, equivalently, forces the total field to be equal to the background field. Apply this boundary condition on external boundaries that are at a distance far enough from the system so that its effect on the background field is negligible.

Magnetic Shielding

The **Magnetic Shielding** node adds a boundary condition for magnetic shielding. It describes a thin layer of a highly permeable medium that shields the magnetic field. The boundary condition uses the following equations for the normal magnetic flux density discontinuity and the tangential magnetic field inside the layer:

$$\mathbf{n} \cdot (\mathbf{B}_1 - \mathbf{B}_2) = \nabla_t \cdot (d_s \mathbf{B}_t(\mathbf{H}_t))$$
$$\mathbf{H}_t = -\nabla_t V_m$$

In these equations, ∇_t represents a tangential derivative (gradient), and d_s is the surface thickness.

MAGNETIC SHIELDING

Enter a value or expression for the **Surface thickness** d_s (SI unit: m).

Relative Permeability

Select **Relative permeability** μ_r (dimensionless) to use the constitutive relation $\mathbf{B} = \mu_0 \mu_r \mathbf{H}$. The default uses values **From material**. For **User defined** enter another value or expression.

B-H Curve

Select **B-H curve** $|\mathbf{B}|$ (SI unit: T) to use a curve that relates magnetic field \mathbf{H} and the magnetic flux density \mathbf{B} as $|\mathbf{B}| = f(|\mathbf{H}|)$. The **Magnetic flux density norm** setting can take the values **From material** or **User defined**.

Magnetic Scalar Potential Discontinuity

The **Magnetic Scalar Potential Discontinuity** node adds a boundary condition on an interior boundary which allows for a prescribed discontinuity in the magnetic scalar potential. The difference in magnetic scalar potential through this boundary is given by

$$V_m^u - V_m^d = V_{m,d}$$

where V_m^u is the magnetic scalar potential on the upside of the boundary selection and V_m^d is the magnetic scalar potential on the downside.

When applied to a cut boundary making a nonsimply connected region simply connected, this feature formally represents a surface current flowing along the boundaries connecting the upside and downside boundaries.

Thin Low Permeability Gap

The **Thin Low Permeability Gap** node adds a boundary condition on an interior boundary which allows for a discontinuity in the magnetic scalar potential. This feature represents a thin layer in a magnetic material filled with another material that has smaller relative magnetic permeability. Use this feature to model, for example, an air gap in a magnetic circuit. Enter a relative magnetic permeability μ_r for the thin layer material as well as a thickness d_s . The difference in magnetic flux through this boundary is given by

$$\mathbf{n} \cdot (\mathbf{B}_1 - \mathbf{B}_2) = \mu_0 \mu_r \left(\frac{V_m^d - V_m^u}{d_s} \right)$$

where V_m^u is the magnetic scalar potential on the upside of the boundary selection and V_m^d is the magnetic scalar potential on the downside.

THIN LOW PERMEABILITY GAP

The default **Relative permeability** μ_r (dimensionless) uses values **From material**. For **User defined** enter a different value or expression. Enter a value or expression for the **Surface thickness** d_s (SI unit: m).

Archie's Law

See the [Archie's Law](#) section in the [Electric Field Interfaces](#) chapter.

The Magnetic Fields, No Currents, Boundary Elements Interface

The **Magnetic Fields, No Currents, Boundary Elements (mfncbe)** interface () is found under the **AC/DC>Magnetic Fields, No Currents** branch when adding a physics interface, is used to compute magnetostatic fields from permanent magnets and other current free magnetic sources. It can also be coupled to [The Magnetic Fields, No Currents Interface](#) or [The Magnetic Fields Interface](#) to account for outer, current free regions as an alternative to using Infinite Elements. The formulation is stationary. The physics interface solves Gauss' Law for the magnetic field using the scalar magnetic potential as the dependent variable.

$$-\nabla \cdot (\mu_0 \mu_r \nabla V_m) = 0.$$



For a discussion about the boundary element method, see [Theory for the Boundary Elements PDE](#) in the *COMSOL Multiphysics Reference Manual*.

When this physics interface is added, these default nodes are also added to the **Model Builder** — **Magnetic Flux Conservation**, **Magnetic Insulation** (on exterior boundaries) and **Initial Values**. Then, from the **Physics** toolbar, add other nodes that implement, for example, magnetic scalar potential and magnetic flux density conditions. You can also right-click **Magnetic Fields, No Currents, Boundary Elements** to select physics features from the context menu.



If both [The Magnetic Fields, No Currents Interface](#) and [The Magnetic Fields, No Currents, Boundary Elements Interface](#) are available, the [Magnetic Scalar-Scalar Potential Coupling](#) node is available from the **Multiphysics** menu in the **Physics** toolbar or by right-clicking the **Multiphysics Couplings** node in **Model Builder**.



If both [The Magnetic Fields Interface](#) and [The Magnetic Fields, No Currents, Boundary Elements Interface](#) are available, the [Magnetic Vector-Scalar Potential Coupling](#) node is available from the **Multiphysics** menu in the **Physics** toolbar or by right-clicking the **Multiphysics Couplings** node in **Model Builder**.

Physics-Controlled Mesh

The physics-controlled mesh is controlled from the **Mesh** node's **Settings** window (if the **Sequence type** is **Physics-controlled mesh**). There, in the table in the **Physics-Controlled Mesh** section, find the physics interface in the **Contributor** column and select or clear the check box in the **Use** column on the same table row for enabling (the default) or disabling contributions from the physics interface to the physics-controlled mesh.

Information from the physics will be used to automatically set up an appropriate mesh sequence.



In the *COMSOL Multiphysics Reference Manual* see the [Physics-Controlled Mesh](#) section for more information about how to define the physics-controlled mesh.

DOMAIN SELECTION

From the **Selection** list, select any of the options — **Manual**, **All domains**, **All voids**, or **All domains and voids** (the default). The geometric entity list displays the selected domain entity numbers. Edit the list of selected domain entity numbers using the selection toolbar buttons to the right of the list or by selecting the geometric entities in the **Graphics** window. Entity numbers for voids can be entered by clicking the Paste () button in the selection toolbar and supplying the entity numbers in the in the dialog box. The entity number for the infinite void is 0, and finite voids have negative entity numbers.

Selections can also be entered using the **Selection List** window, available from the **Windows** menu on the **Home** toolbar.





For more information about making selections, see [Working with Geometric Entities](#) in the *COMSOL Multiphysics Reference Manual*.

PHYSICS SYMBOLS

Select the **Enable physics symbols** check box to display symmetry planes (in 3D) and lines (in 2D) in the **Graphics** window, as specified in the [Symmetry](#) settings.

SYMMETRY

	For 3D components, from the Symmetry in the yz plane , Symmetry in the xz plane , Symmetry in the xy plane lists, choose Off (the default), Symmetric (infinite magnetic insulation plane), or Antisymmetric (infinite ground plane). Then enter a Plane position (SI unit: m) as required.
	For 2D components, from the Symmetry in the line perpendicular to x and Symmetry in the line perpendicular to y lists, choose Off (the default), Symmetric (infinite magnetic insulation line), or Antisymmetric (infinite ground line). Then enter a Line position (SI unit: m) as required.

FAR FIELD APPROXIMATION

To display this section, click the **Show More Options** button () and select **Advanced Physics Options**.

	For more information about the Far Field Approximation settings, see Far-Field Approximation Settings in the <i>COMSOL Multiphysics Reference Manual</i> .
---	---

QUADRATURE



To display this section, click the **Show More Options** button () and select **Advanced Physics Options**.

	For more information about the Quadrature settings, see Quadrature in the <i>COMSOL Multiphysics Reference Manual</i> .
---	--

THICKNESS (2D COMPONENTS)

For 2D components, enter a default value for the **Out-of-plane thickness** d (SI unit: m). The default value of 1 unit length is typically not representative for a thin domain. Instead it describes a unit thickness that makes the 2D equation identical to the equation used for 3D components.

INFINITY CONDITION

	<p>For 3D components, select the Infinity condition — Magnetic insulation (the default) or Zero magnetic scalar potential at infinity. If there is an antisymmetric symmetry in the potential field, it acts as an added infinite ground plane with a fixed value of the magnetic scalar potential. The value at infinity is fixed to 0 by the presence of the infinite ground plane, so for this case there is only a fixed Zero magnetic scalar potential at infinity condition.</p>
	<p>For 2D components, select the Infinity condition — Magnetic insulation (the default) or Zero magnetic scalar potential at reference distance. If there is an antisymmetric symmetry in the potential field, it acts as an added ground line with a fixed value of the magnetic scalar potential. The value at a reference distance is fixed to 0 by the presence of the ground line, so for this case there is only a fixed Zero magnetic scalar potential at reference distance condition.</p>

DISCRETIZATION

From the **Magnetic scalar potential/Magnetic flux density** list, choose from predefined options for the boundary element discretization order for the magnetic scalar potential variable and the magnetic flux density variable, respectively. The predefined options represent the suitable combinations of element orders such as **Quadratic/Linear** (the default).

The settings under **Value types when using splitting of complex variables** are important for sensitivity and optimization computations. See the description of the built-in operators `fsens` and `fsensimag`.

DEPENDENT VARIABLES

The dependent variable (field variable) is for the **Magnetic scalar potential** V_m . The name can be changed but the names of fields and dependent variables must be unique within a model.

Domain and Boundary Nodes for the Magnetic Fields, No Currents, Boundary Elements Interface

[The Magnetic Fields, No Currents, Boundary Elements Interface](#) has these domain and boundary nodes available from the **Physics** ribbon (Windows users), **Physics**

context menu (macOS or Linux users), or by right-clicking the physics interface in the **Model Builder** to access the context menu (all users).



In general, to add a node, go to the **Physics** toolbar, no matter what operating system you are using. Subnodes are available by clicking the parent node and selecting it from the **Attributes** menu.

AVAILABLE NODES

These nodes and subnodes are described in this section:

- [Magnetic Flux Conservation](#)
- [Force Calculation](#)¹
- [Magnetic Insulation](#)
- [Initial Values](#)
- [Zero Magnetic Scalar Potential](#)
- [Magnetic Scalar Potential](#)
- [Magnetic Flux Density](#)
- [Magnetic Scalar-Scalar Potential Coupling](#)
- [Magnetic Vector-Scalar Potential Coupling](#)

¹ Described for another physics interface in this user guide.

Magnetic Flux Conservation

The **Magnetic Flux Conservation** node adds [Equation 5-5](#) (or a similar equation depending on the selected constitutive relation) for the magnetic scalar potential and provides an interface for defining the constitutive relation and the relevant material properties (for example, the relative permeability).

CONSTITUTIVE RELATION B-H



See the settings for Constitutive Relation B-H under [Ampère's Law](#). Notice that the Magnetic Fields, No Currents, Boundary Elements interface supports the following constitutive relations only: **Relative permeability**, **Remanent flux density**, and **Magnetization**.



Notice that the boundary element method is based on the availability of an analytic Green's function for the domain. Thus, the **Relative permeability** must evaluate to a constant value for each **Magnetic Flux Conservation** node.

Magnetic Insulation

The **Magnetic Insulation** node for the Magnetic Fields, No Currents, Boundary Elements interface provides the default boundary condition. The magnetic insulation boundary condition sets the normal component of the magnetic flux density to zero:

$$\mathbf{n} \cdot \mathbf{B} = 0$$



This condition is useful at boundaries confining a surrounding region of air or to model symmetry cuts.

Initial Values

Initial Values adds an initial value for the magnetic scalar potential that can serve as an initial condition for a transient simulation or as an initial guess for a nonlinear solver. Add more **Initial Values** nodes from the **Physics** toolbar, **Global** menu.

INITIAL VALUES

Enter a value or expression for the initial value of the **Magnetic scalar potential** V_m . The default value is 0 A.

Zero Magnetic Scalar Potential

The **Zero Magnetic Scalar Potential** node provides a boundary condition that specifies a zero magnetic potential on the boundary $V_m = 0$.

CONSTRAINT SETTINGS

To display this section, click the **Show More Options** button () and select **Advanced Physics Options**.

Magnetic Scalar Potential

The **Magnetic Scalar Potential** node adds a boundary condition for the magnetic scalar potential:

$$V_m = V_{m0}$$

MAGNETIC SCALAR POTENTIAL

Enter a value or expression for the **Magnetic scalar potential** V_{m0} (SI unit: A). The default is 0 A.

CONSTRAINT SETTINGS

To display this section, click the **Show More Options** button () and select **Advanced Physics Options**.

Magnetic Flux Density

The **Magnetic Flux Density** node adds a boundary condition for the magnetic flux density.

MAGNETIC FLUX DENSITY



See the settings for [Magnetic Flux Density](#) in the Magnetic Fields, No Currents documentation. Notice that the Magnetic Fields, No Currents, Boundary Elements interface supports the **Inward flux density** option only.

Magnetic Scalar-Scalar Potential Coupling

The **Magnetic Scalar-Scalar Potential Coupling** multiphysics node assures continuity of the magnetic scalar potential across boundaries between [The Magnetic Fields, No Currents Interface](#) and [The Magnetic Fields, No Currents, Boundary Elements Interface](#). The **Magnetic Scalar-Scalar Potential Coupling** node is available from the **Multiphysics** menu in the **Physics** toolbar or by right-clicking the **Multiphysics Couplings** node in **Model Builder**, if both [The Magnetic Fields, No Currents Interface](#) and [The Magnetic Fields, No Currents, Boundary Elements Interface](#) are available.



The [Magnetic Fields, No Currents Interface](#) can be set to solve for the **Reduced field** using the [Background Magnetic Field](#) setting. [The Magnetic Fields, No Currents, Boundary Elements Interface](#) does not have such a setting but it can be made to represent an open boundary for the reduced field by adding, in [The Magnetic Fields, No Currents Interface](#), an [External Magnetic Flux Density](#) feature on the boundary selection for the **Magnetic Scalar-Scalar Potential Coupling**.



When using [The Magnetic Fields, No Currents, Boundary Elements Interface](#) with iterative solvers, **Right Preconditioning** is preferred. Thus, it is advised to check that **Right Preconditioning** is used when combining the **Magnetic Scalar-Scalar Potential Coupling** with [The Magnetic Fields, No Currents, Boundary Elements Interface](#) and other physics interfaces. How to define **Right Preconditioning** is described in [Iterative](#) in the *COMSOL Multiphysics Reference Manual*.

BOUNDARY SELECTION

Select **Manual** or **All boundaries** from the **Selection** list. Make additional edits to the list of boundary entity numbers using the Selection toolbar buttons. When **All boundaries** is selected from the **Selection** list, the boundaries exterior to the Magnetic Fields, No Currents interface that intersect the exterior boundaries to the Magnetic Fields, No Currents, Boundary Elements interface are available in the boundary entity number list.



When using the symmetry options at the physics interface level as discussed in [Symmetry](#), there will be no degrees of freedom on the symmetry planes. For such cases, please make sure that the coupling selection does not contain boundaries that intersect with the symmetry planes.

COUPLED INTERFACES

Select **Magnetic Fields, No Currents** as **Primary interface** and **Magnetic Fields, No Currents, Boundary Elements** as **Secondary interface**.

Magnetic Vector-Scalar Potential Coupling

The **Magnetic Vector-Scalar Potential Coupling** multiphysics node assures continuity of the magnetic flux density across boundaries between [The Magnetic Fields Interface](#) and [The Magnetic Fields, No Currents, Boundary Elements Interface](#). The **Magnetic Vector-Scalar Potential Coupling** node is available from the **Multiphysics** menu in the **Physics** toolbar or by right-clicking the **Multiphysics Couplings** node in **Model Builder**, if

both [The Magnetic Fields Interface](#) and [The Magnetic Fields, No Currents, Boundary Elements Interface](#) are available.



[The Magnetic Fields Interface](#) can be set to solve for the **Reduced field** using the [Background Magnetic Field](#) setting. [The Magnetic Fields, No Currents, Boundary Elements Interface](#) does not have such a setting but it can be made to represent an open boundary for the reduced field by adding, in [The Magnetic Fields Interface](#), a [Magnetic Field](#) feature with the background magnetic field on the boundary selection for the **Magnetic Vector-Scalar Potential Coupling**.



When combining [The Magnetic Fields, No Currents, Boundary Elements Interface](#) with [The Magnetic Fields Interface](#), the latter has to use [Gauge Fixing for A-Field](#) and a solved using Fully Coupled and a Direct solver, see the *COMSOL Multiphysics Reference Manual* for details on [Fully Coupled](#) and [Direct](#).

BOUNDARY SELECTION

Select **Manual** or **All boundaries** from the **Selection** list. Make additional edits to the list of boundary entity numbers using the Selection toolbar buttons. When **All boundaries** is selected from the **Selection** list, the boundaries exterior to the Magnetic Fields interface that intersect the exterior boundaries to the Magnetic Fields, No Currents, Boundary Elements interface are available in the boundary entity number list.



When using the symmetry options at the physics interface level as discussed in [Symmetry](#), there will be no degrees of freedom on the symmetry planes. For such cases, please make sure that the coupling selection does not contain boundaries that intersect with the symmetry planes.

COUPLED INTERFACES

Select **Magnetic Fields** as **Primary interface** and **Magnetic Fields, No Currents, Boundary Elements** as **Secondary interface**.

The Rotating Machinery, Magnetic Interface

The **Rotating Machinery, Magnetic (rmm)** interface (), found under the **AC/DC>Electromagnetics and Mechanics** branch when adding a physics interface, is used for design and analysis of electric motors and generators. Stationary and time-domain modeling is supported in 2D and 3D.

The physics interface solves Maxwell's equations formulated using a combination of magnetic vector potential and magnetic scalar potential as the dependent variables.

When this physics interface is added, these default nodes are also added to the **Model Builder** — **Electric Field Transformation, Ampère's Law, Mixed Formulation Boundary, Magnetic Insulation** (the default boundary condition), and **Initial Values**. Then, from the **Physics** toolbar, add other nodes that implement, for example, boundary conditions and point conditions. You can also right-click **Rotating Machinery, Magnetic** to select physics features from the context menu.



The physics interface only works correctly if the geometry is created as an assembly pair from individual composite objects for the rotor and stator parts. An identity pair must also be defined for the rotor-stator physics interface boundaries under the **Model>Definitions** node in the **Model Builder**.

Physics-Controlled Mesh

The physics-controlled mesh is controlled from the **Mesh** node's **Settings** window (if the **Sequence type** is **Physics-controlled mesh**). There, in the table in the **Physics-Controlled Mesh** section, find the physics interface in the **Contributor** column and select or clear the check box in the **Use** column on the same table row for enabling (the default) or disabling contributions from the physics interface to the physics-controlled mesh.

Information from the physics, such as the presence of an infinite elements domain or periodic condition, will be used to automatically set up an appropriate mesh sequence.



In the *COMSOL Multiphysics Reference Manual* see the [Physics-Controlled Mesh](#) section for more information about how to define the physics-controlled mesh.



Only nodes unique to the Rotating Machinery, Magnetic interface are described in this section. Most nodes are described for [The Magnetic Fields Interface](#) or [The Magnetic Fields, No Currents Interface](#).

SETTINGS

The **Label** is the default physics interface name.

The **Name** is used primarily as a scope prefix for variables defined by the physics interface. Refer to such physics interface variables in expressions using the pattern `<name>.<variable_name>`. In order to distinguish between variables belonging to different physics interfaces, the `name` string must be unique. Only letters, numbers, and underscores (`_`) are permitted in the **Name** field. The first character must be a letter.

The default **Name** (for the first physics interface in the model) is `rmm`.

BACKGROUND FIELD

Select an option from the **Solve for** list — **Full field** (the default) or **Reduced field**. For **Reduced field** specify a **Background magnetic vector potential** \mathbf{A}_b (SI unit: Wb/m). The entered expressions must be differentiable.



Notice that expressions including coupling operators are not differentiable and cannot be used as background fields.

The total field used in the physics and equations are given by the sum of the reduced and background fields.

COMPONENTS

For 2D components, select the **Components** — **Out-of-plane vector potential** (the default), **In-plane vector potential**, or **Three-component vector potential**.

THICKNESS

For 2D components, enter a value or expression for the global **Out-of-plane thickness** d (SI unit: m). The default value of 1 m is typically not representative for a thin domain. Instead it describes a unit thickness that makes the 2D equation identical to the equation used for 3D components.

PORT SWEEP SETTINGS

Select the **Activate port sweep** check box and enter a **Sweep parameter name** in the field. The default is PortName.

The lumped parameters computed can be subject to a **Touchstone file export**. To activate this functionality, enter a file path or click **Browse** to navigate to a file. Select a **Parameter format (value pairs)** for the Touchstone export — **Magnitude and angle (MA)** (the default), **Magnitude in dB and angle (DB)**, or **Real and imaginary parts (RI)**. Select the desired operation to perform from the **If file exists** list — **Overwrite** (the default) or **Create new**. The latter is useful when the model is solved multiple times with different settings. Enter a **Reference impedance, Touchstone file export** Z_{ref} (SI unit: Ω). The default is 50 Ω .

ERROR CHECK

To display this section, click the **Show More Options** button () and select **Advanced Physics Options**.

When the **Check applicability of features in study** check box is selected, any features that are incompatible with the study will generate an error message when trying to solve or show the default solver. No solver will be generated. Deselect it and you will be able to run the model, possibly with runtime errors instead. It is available to allow the advanced user to tweak any feature and use it outside of its intended study scope.

DEPENDENT VARIABLES

The dependent variables (field variables) are the **Magnetic vector potential** \mathbf{A} and the **Magnetic scalar potential** V_m . The name can be changed but the names of fields and dependent variables must be unique within a model.

DISCRETIZATION



Domain, Boundary, Edge, Point, and Pair Nodes for the Rotating Machinery, Magnetic Interface



- *Generator in 2D*: Application Library path
ACDC_Module/Motors_and_Actuators/generator_2d
- *Rotating Machinery 3D Tutorial*: Application Library path
ACDC_Module/Motors_and_Actuators/rotating_machinery_3d_tutorial

Domain, Boundary, Edge, Point, and Pair Nodes for the Rotating Machinery, Magnetic Interface

The [Rotating Machinery, Magnetic Interface](#) has these boundary, edge, pair, and point nodes available from the **Physics** ribbon toolbar (Windows users), **Physics** context menu (Mac or Linux users), or right-click to access the context menu (all users).



In general, to add a node, go to the **Physics** toolbar, no matter what operating system you are using. Subnodes are available by clicking the parent node and selecting it from the **Attributes** menu.

FEATURES AVAILABLE FROM SUBMENUS

Many features for this interface are added from submenus in the Physics toolbar groups or context menu (when you right-click the node). The submenu name is the same in both cases. The **Domain** and **Boundary** level submenus are **Vector Potential** and **Scalar Potential**. There are also the **Pairs** and **Points** submenu.

LINKS TO FEATURE NODE INFORMATION

These domain nodes are described in this section:

- [Electric Field Transformation](#)
- [Initial Values](#)
- [Mixed Formulation Boundary](#)
- [Prescribed Rotation](#)
- [Prescribed Rotational Velocity](#)



In the *COMSOL Multiphysics Reference Manual* see [Table 2-4](#) for links to common sections and [Table 2-5](#) to common feature nodes. You can also search for information: press F1 to open the **Help** window or Ctrl+F1 to open the **Documentation** window.

These boundary, edge, pair, and point nodes are described for the main physics interfaces that solve for the magnetic vector potential (Magnetic Fields) and the magnetic scalar potential (Magnetic Fields, No Currents). The nodes listed in alphabetical order are:

- Ampère's Law¹
- Boundary Feed
- Override Coil Inlet/Outlet
- Edge Current
- Electric Point Dipole
- Electric Point Dipole (on Axis)
- External Current Density¹
- External Magnetic Vector Potential
- Force Calculation
- Gap Feed
- Ground
- Line Current (Out-of-Plane)
- Lumped Element¹
- Lumped Port¹
- Magnetic Field¹
- Magnetic Flux Conservation²
- Magnetic Flux Density²
- Magnetic Potential¹
- Magnetic Point Dipole
- Magnetic Scalar Potential²
- Magnetic Shielding¹
- Coil¹
- Perfect Magnetic Conductor¹
- Periodic Condition
- Sector Symmetry
- Single-Turn Coil¹
- Surface Current¹
- Thin Low Permeability Gap¹
- Velocity (Lorentz Term)¹
- Zero Magnetic Scalar Potential²

¹ Select this from the **Vector Potential** submenu for this interface.

² Select this from the **Scalar Potential** submenu for this interface.

Initial Values

The **Initial Values** node adds an initial value for the magnetic vector potential.

INITIAL VALUES

Enter a value or expression for the initial value of the **Magnetic vector potential \mathbf{A}** (SI unit: Wb/m).

Electric Field Transformation

The **Electric Field Transformation** node imposes suitable transformations to the electric field definitions in all domains depending on rotational velocity.

Prescribed Rotation

The **Prescribed Rotation** node imposes a coordinate transformation to the selected domain that effectively rotates it a prescribed angle. It is used to model a rotating part. The angle can also be time-dependent.

PRESCRIBED ROTATION

Enter the **Rotation angle** α_{rot} (SI unit: radians).

- For 2D components, enter the **X** and **Y** coordinates for the **Rotation axis base point** \mathbf{r}_{ax} (SI unit: m) identifying the fixed point of the rotation. The axis of rotation is the z (out-of-plane) axis.
- For 3D components, specify the rotation axis by entering the coordinates of the **Rotation axis base point** \mathbf{r}_{ax} (SI unit: m) and the components of the **Rotation axis** \mathbf{u}_{rot} (dimensionless).

Prescribed Rotational Velocity

The **Prescribed Rotational Velocity** node imposes a coordinate transformation to the selected domain that effectively rotates it a prescribed angle that grows linearly with time. It is used to model a rotating part at a constant rotational velocity. To model a part rotating at a nonconstant angular velocity, use instead the [Prescribed Rotation](#) feature with a time-dependent angle.

PRESCRIBED ROTATIONAL VELOCITY

Enter a constant value for the **Constant angular velocity (revolutions per second)** input rps (SI unit: Hz) and the **Initial angle** α_0 (SI unit: rad).

- For 2D components, enter the **X** and **Y** coordinates for the **Rotation axis base point** \mathbf{r}_{ax} (SI unit: m) identifying the fixed point of the rotation. The axis of rotation is the z (out-of-plane) axis.
- For 3D components, specify the rotation axis by entering the coordinates of the **Rotation axis base point** \mathbf{r}_{ax} (SI unit: m) and the components of the **Rotation axis** \mathbf{u}_{rot} (dimensionless).

Magnetic Insulation

The **Magnetic Insulation** node is the default external boundary condition for the Rotating Machinery, Magnetic interface. It adds a boundary condition that, on boundaries with magnetic vector potential (Ampère's Law domains) sets the tangential components of the magnetic potential to zero at the boundary $\mathbf{n} \times \mathbf{A} = 0$. On external boundaries with magnetic scalar potential (Magnetic Flux Conservation domains) it sets the normal component of the magnetic flux density to zero $\mathbf{n} \cdot \mathbf{B} = 0$.



As external boundary condition, it is useful at boundaries confining a surrounding region of air or to model symmetry cuts.

For the magnetic vector potential, Magnetic insulation is a special case of the magnetic potential boundary condition that sets the tangential component of the magnetic potential to zero and can be used for the modeling of a lossless metallic surface, for example, a ground plane or as a symmetry type boundary condition. The Magnetic Insulation node can also be applied on interior boundaries in vector potential domains. For more details on this, see also the corresponding documentation section in the Magnetic Fields interface on [Magnetic Insulation](#).

Mixed Formulation Boundary

The **Mixed Formulation Boundary** node imposes continuity between the magnetic scalar potential on one side of the boundary and the magnetic vector potential on the other side. This feature is added by default and is applied automatically to all appropriate boundaries.

The Magnetic and Electric Fields Interface

The **Magnetic and Electric Fields (mef)** interface () , found under the **AC/DC>Electromagnetic Fields>Vector Formulations** branch when adding a physics interface, is used to compute magnetic field and current distributions when the exciting current is driven by an applied voltage. Stationary, and frequency-domain modeling are supported in 2D and 3D. Note that in most cases, using the Magnetic Fields interface with its dedicated coil modeling features is the preferred choice over using the Magnetic and Electric Fields interface.

The physics interface solves Maxwell's equations formulated using the magnetic vector potential and the scalar electric potential as the dependent variables.



In three-dimensional components, if the conduction current in the modeled system is confined only in some regions (for example, a metallic coil) and most of the domains are nonconductive, it is recommended to use the Magnetic Fields interface and apply the Single Turn Coil domain node on the conductive regions, instead of using this physics interface.

Use the Magnetic and Electric Fields interface when the current continuity equation is needed everywhere in the simulation domain.

The main node is the **Ampère's Law and Current Conservation** feature, which adds the equation for the electric potential and magnetic vector potential and provides an interface for defining the constitutive relations and their associated properties such as the relative permeability, relative permittivity, and electrical conductivity.

The [Ampère's Law and Current Conservation](#) feature can be overridden with an **Ampère's Law** feature or a **Coil** feature, that are identical to the ones in the **Magnetic Fields** interface, removing the electric potential and the current conservation equation from the selected domains.

When this physics interface is added, these default nodes are also added to the **Model Builder**— **Ampère's Law and Current Conservation**, **Magnetic Insulation** (the default boundary condition for the magnetic vector potential), and **Initial Values**. Then, from the **Physics** toolbar, add other nodes that implement, for example, boundary

conditions and external currents. You can also right-click **Magnetic and Electric Fields** to select physics features from the context menu.

Physics-Controlled Mesh

The physics-controlled mesh is controlled from the **Mesh** node's **Settings** window (if the **Sequence type** is **Physics-controlled mesh**). There, in the table in the **Physics-Controlled Mesh** section, find the physics interface in the **Contributor** column and select or clear the check box in the **Use** column on the same table row for enabling (the default) or disabling contributions from the physics interface to the physics-controlled mesh.

Information from the physics, such as the presence of an infinite elements domain or periodic condition, will be used to automatically set up an appropriate mesh sequence.



In the *COMSOL Multiphysics Reference Manual* see the [Physics-Controlled Mesh](#) section for more information about how to define the physics-controlled mesh.



Except where described below, most **Settings** windows are the same as for the Magnetic Fields, Electrostatics, and Electric Currents interfaces. Also see [About the Magnetic and Electric Field Interface Boundary Conditions](#) for more information.

SETTINGS

The **Label** is the default physics interface name.

The **Name** is used primarily as a scope prefix for variables defined by the physics interface. Refer to such physics interface variables in expressions using the pattern `<name>.<variable_name>`. In order to distinguish between variables belonging to different physics interfaces, the `name` string must be unique. Only letters, numbers, and underscores (`_`) are permitted in the **Name** field. The first character must be a letter.

The default **Name** (for the first physics interface in the model) is `mef`.

BACKGROUND FIELD

The only option available from the **Solve for** list is **Full field**.

COMPONENTS



For 2D and 2D axisymmetric components, select **Components** — **Out-of-plane vector potential** (the default), **In-plane vector potential**, or **Three-component vector potential**. From the practical viewpoint this choice is equivalent to deciding in what directions the electric current is allowed to flow (out-of-plane currents, in-plane currents or currents flowing in all three coordinate directions).

THICKNESS



Enter a value or expression for the **Out-of-plane thickness** d . The default value of 1 unit length is typically not representative for a thin domain. Instead it describes a unit thickness that makes the 2D equation identical to the equation used for 3D components.

INPUT SWEEP SETTINGS

Enter a **Reference impedance** Z_{ref} (SI unit: Ω). The default is 50 Ω . This impedance is used by **Terminal** features (when the **Terminal Type** is set to **Terminated**) and the **Touchstone file export** functionality.

Select the **Activate input sweep** check box to switch on the sweep and invoke a parametric sweep over the Lumped ports or the Terminal nodes.

Select an option from the **Sweep on** list — **Terminals** or **Ports**. This setting controls which features are activated during the sweep.

Enter a **Sweep parameter name** to indicate the name of the model parameter that controls the terminal or port activated in each step of the sweep. The default is PortName. The name given must match the model parameter, defined under **Global Definitions**, that is the object of a **Parametric Sweep** node in the current **Study**.

The lumped parameters computed can be subject to a **Touchstone file export**. To activate this functionality, enter a file path or **Browse** for a file. Select a **Parameter format (value pairs)** for the Touchstone export — **Magnitude and angle (MA)** (the default), **Magnitude in dB and angle (DB)**, or **Real and imaginary parts (RI)**. Select an option from the **If file exists** list — **Overwrite** or **Create new**. Create new is useful when the model is solved multiple times with different settings. Select a **Parameter to export** — **Z** (the default), **Y**, or **S**.

When **Terminals** is selected under **Sweep on**, also select a **Parameter to export** — **Z** (the default), **Y**, or **S**. When the sweep is carried on **Ports**, the exported parameter is always **S**.

ERROR CHECK



To display this section, click the **Show More Options** button () and select **Advanced Physics Options**.

When the **Check applicability of features in study** check box is selected, any features that are incompatible with the study will generate an error message when trying to solve or show the default solver. No solver will be generated. Deselect it and you will be able to run the model, possibly with runtime errors instead. It is available to allow the advanced user to tweak any feature and use it outside of its intended study scope.

DEPENDENT VARIABLES

The dependent variables (field variables) are for the **Electric potential V** and **Magnetic vector potential A**. The name can be changed but the names of fields and dependent variables must be unique within a model.

DISCRETIZATION

	<ul style="list-style-type: none">• About the Magnetic and Electric Field Interface Boundary Conditions• Lumped Parameters• Domain, Boundary, Edge, Point, and Pair Nodes for the Magnetic and Electric Fields Interface• Theory for the Magnetic and Electric Fields Interface
	<ul style="list-style-type: none">• <i>Magnetic Brake</i>: Application Library path ACDC_Module/Motors_and_Actuators/magnetic_brake• <i>Inductance of a Power Inductor</i>: Application Library path ACDC_Module/Inductive_Devices_and_Coils/power_inductor

About the Magnetic and Electric Field Interface Boundary Conditions

The Magnetic and Electric Fields interface boundary conditions are applied in a two-step procedure. This is because only some combinations of electric and magnetic

boundary conditions are physically relevant whereas others can lead to nonphysical models that violate the current conservation law.



The basic steps for this are to add the magnetic boundary conditions from the **Physics** toolbar. Then right-click these magnetic boundary condition nodes to add compatible electric boundary conditions as subnodes.

STEP 1: MAGNETIC BOUNDARY CONDITIONS

With no surface currents present the physics interface conditions

$$\mathbf{n}_2 \times (\mathbf{A}_1 - \mathbf{A}_2) = \mathbf{0}$$

$$\mathbf{n}_2 \times (\mathbf{H}_1 - \mathbf{H}_2) = \mathbf{0}$$

need to be fulfilled. Because the physics interface solves for \mathbf{A} , the tangential component of the magnetic potential is always continuous, and thus the first condition is automatically fulfilled. The second condition is equivalent to the natural boundary condition and is hence also fulfilled unless surface currents are explicitly introduced.

STEP 2: ELECTRIC BOUNDARY CONDITIONS

The relevant physics interface condition at interfaces between different media and interior boundaries is continuity; that is,

$$\mathbf{n}_2 \cdot (\mathbf{J}_1 - \mathbf{J}_2) = 0$$

which is the natural boundary condition.



A default **Electric Insulation** node is also added under the default **Magnetic Insulation** node. This is to ensure that default boundary conditions are always specified both for the magnetic vector potential and the electric potential. Additional subnodes are available from the context menu (right-click the parent node) or from the **Physics** toolbar, **Attributes** menu.

Table 5-4 lists the interior and exterior boundary conditions available with this physics interface.

TABLE 5-4: INTERIOR AND EXTERIOR ELECTRIC AND MAGNETIC BOUNDARY CONDITIONS FOR THE MAGNETIC AND ELECTRIC FIELDS INTERFACE

NODE	INTERIOR	EXTERIOR
MAGNETIC BOUNDARIES		
Impedance Boundary Condition		x
Lumped Port	x	x
Magnetic Continuity	x	
Magnetic Field		x
Magnetic Insulation	x	x
Magnetic Potential	x	x
Magnetic Shielding	x	
Perfect Magnetic Conductor	x	x
Surface Current	x	x
Thin Low Permeability Gap	x	
Transition Boundary Condition	x	
Coil	x	
ELECTRIC BOUNDARIES		
Contact Impedance	x	
Electric Insulation	x	x
Electric Potential	x	x
Electric Shielding	x	
Floating Potential	x	x
Ground	x	x
Normal Current Density		x
Periodic Condition		x

BOUNDARY CONDITION COMBINATIONS

Table 5-5 shows the possible combination of magnetic and electric boundary conditions, with an explanation of the physical model represented by the more advanced combinations.

TABLE 5-5: POSSIBLE COMBINATIONS OF ELECTRIC AND MAGNETIC BOUNDARY CONDITIONS FOR THE MAGNETIC AND ELECTRIC FIELDS INTERFACE

MAGNETIC FEATURE	ELECTRIC FEATURE	PHYSICAL MODEL
Magnetic Insulation	Electric Insulation	
	Electric Potential	
	Ground	
	Floating Potential	
	Terminal	
	Normal Current Density	
Magnetic Continuity	<none>	<no effect>
	Electric Insulation	Thin nonconducting, nonmagnetic layer, such as an air gap or crack in a metal.
	Contact Impedance	Thin resistive, nonmagnetic layer, such as an oxide layer in a metal.
Magnetic Shielding	<none>	Magnetic (high- μ_r) layer with same conductive properties as the surrounding medium.
	Electric Shielding	Thin magnetic, highly conductive layer (high- μ_r , high- σ).
	Electric Insulation	Thin nonconducting magnetic layer.
	Contact Impedance	Thin resistive magnetic layer.
Surface Current	<none>	Externally imposed surface current density.
	Electric Shielding	Thin nonmagnetic, highly conductive layer along which a surface current density flows, that is automatically included in the parent node.

Domain, Boundary, Edge, Point, and Pair Nodes for the Magnetic and Electric Fields Interface

The [Magnetic and Electric Fields Interface](#) has these domain, boundary, edge, point, and pair nodes available from the **Physics** ribbon toolbar (Windows users), **Physics**

context menu (Mac or Linux users), or right-click to access the context menu (all users).



In general, to add a node, go to the **Physics** toolbar, no matter what operating system you are using. Subnodes are available by clicking the parent node and selecting it from the **Attributes** menu.

Also see [About the Magnetic and Electric Field Interface Boundary Conditions](#) and [Table 5-1](#) for a list of interior and exterior boundary conditions.



For axisymmetric components, COMSOL Multiphysics takes the axial symmetry boundaries (at $r = 0$) into account and automatically adds an **Axial Symmetry** node to the component that is valid on the axial symmetry boundaries only.

These nodes are described in this section:

- [Ampère's Law and Current Conservation](#)
- [Initial Values](#)
- [Magnetic Continuity](#)
- [Magnetic Insulation](#)
- [Magnetic Shielding](#)
- [RLC Coil Group](#)
- [Surface Current](#)

The following nodes are described for the Magnetic Fields or Electric Currents interfaces,

- Ampère's Law
- Override Coil Inlet/Outlet
- Contact Impedance
- Edge Current
- Electric Insulation
- Electric Point Dipole
- Electric Point Dipole (on Axis)
- Electric Potential
- Electric Shielding
- External Current Density
- Floating Potential
- Force Calculation
- Gauge Fixing for A-Field
- Ground
- Impedance Boundary Condition
- Lumped Element
- Lumped Port
- Magnetic Field
- Magnetic Point Dipole
- Magnetic Potential
- Coil
- Normal Current Density
- Perfect Magnetic Conductor
- Periodic Condition
- Single-Turn Coil
- Terminal
- Thin Low Permeability Gap
- Transition Boundary Condition
- Velocity (Lorentz Term)



- Sector Symmetry
- Infinite Elements, Perfectly Matched Layers, and Absorbing Layers in the *COMSOL Multiphysics Reference Manual*



In the *COMSOL Multiphysics Reference Manual* see [Table 2-4](#) for links to common sections and [Table 2-5](#) to common feature nodes. You can also search for information: press F1 to open the **Help** window or Ctrl+F1 to open the **Documentation** window.

Ampère's Law and Current Conservation

The **Ampère's Law and Current Conservation** node adds Ampère's law and the equation of continuity for the electric current. It provides an interface for defining the constitutive relations and their associated properties.



This feature can be overridden with an [Ampère's Law](#) feature or a [Coil](#) feature, which are identical to the ones in the **Magnetic Fields** interface, removing the electric potential and the current conservation equation from the selected domains.

MATERIAL TYPE

The **Material type** setting decides how materials behave and how material properties are interpreted when the mesh is deformed. Select **Solid** for materials whose properties change as functions of material strain, material orientation and other variables evaluated in a material reference configuration (material frame). Select **Nonsolid** for materials whose properties are defined only as functions of the current local state at each point in the spatial frame, and for which no unique material reference configuration can be defined. Select **From material** to pick up the corresponding setting from the domain material on each domain.



The **Constitutive Relation Jc-E** and **Constitutive Relation B-H** settings are the same as [Ampère's Law](#) for the Magnetic Fields interface. The **Constitutive Relation D-E** settings are the same as for [Current Conservation](#) for the Electric Currents interface.

Initial Values

The **Initial Values** node adds an initial value for the magnetic vector potential and electric potential that can serve as an initial value for a transient simulation or as an initial guess for a nonlinear solver.

INITIAL VALUES

Enter a value or expression for the initial value of the **Magnetic vector potential \mathbf{A}** (SI unit: Wb/m) and initial value of the **Electric potential V** (SI unit: V). The default values are 0 Wb/m and 0 V, respectively.

Magnetic Insulation

The **Magnetic Insulation** node is the default magnetic boundary condition for the Magnetic and Electric Fields interface and sets the tangential components of the magnetic potential to zero at the boundary $\mathbf{n} \times \mathbf{A} = 0$. Electric boundary conditions can be applied by adding subnodes to the **Magnetic Insulation** node. The default electric boundary condition, added under each **Magnetic Insulation** node, is **Electric Insulation**. The **Electric Potential**, **Ground**, **Floating Potential**, **Terminal**, or **Normal Current Density** subnodes are available from the context menu (right-click the parent node) or from the **Physics** toolbar, **Attributes** menu.



About the Magnetic and Electric Field Interface Boundary Conditions

Surface Current

The **Surface Current** node adds a boundary condition for a surface current density \mathbf{J}_s .

An externally applied surface current density can be specified directly in the **Settings** window for the node. Alternatively, the **Electric Shielding** subnode is available from the context menu (right-click the parent node) or from the **Physics** toolbar, **Attributes** menu. Use the subnode to model a thin conductive layer (a layer whose electrical conductivity s is higher than in the surrounding domains). In this case, the electric current flows preferably along the conductive boundary, and the resulting surface current density is automatically incorporated in the parent **Surface Current** node to act as a source for the magnetic field.

SURFACE CURRENT

Enter values or expressions for the **Surface current density** \mathbf{J}_{s0} (SI unit: A/m) coordinates.

Magnetic Shielding

The **Magnetic Shielding** node adds a boundary condition for magnetic shielding. By itself, this feature represents a geometrically thin layer with a relative permeability substantially higher than the surrounding material, that shields the magnetic field.

Subnodes are available from the context menu (right-click the parent node) or from the **Physics** toolbar, **Attributes** menu. Use the subnodes to provide an electrical model

on top of the Shielding magnetic model. The available subnodes are [Electric Shielding](#), [Electric Insulation](#), and [Contact Impedance](#) subnodes. The possible combinations are:

- **Magnetic Shielding** with no subnode: this represents a highly magnetic layer with no special electrical properties.
- **Magnetic Shielding** and **Electric Shielding**: this combination represents a layer in which both the relative permeability μ_r and the electrical conductivity σ are much higher than in the adjacent domain. This layer shields the magnetic field and the current preferentially flows along it. The resulting surface current density is incorporated in the model as a source for the magnetic field.
- **Magnetic Shielding** and **Electric Insulation**: this combination represents a nonconductive magnetic layer. The layer shields the magnetic field and there is no current flowing through it. The electric potential is discontinuous across the boundary.
- **Magnetic Shielding** and **Contact Impedance**: this combination represents a resistive magnetic layer. The layer shields the magnetic field and the current flows preferably orthogonally to the layer. The electric potential is discontinuous across the boundary.

MAGNETIC SHIELDING

The default **Relative permeability** μ_r (dimensionless) uses values **From material**. For **User defined** select **Isotropic**, **Diagonal**, **Symmetric**, or **Full** and enter other values or expressions. For anisotropic material, the relative permeability is a tensor.

Enter a value or expression for the **Surface thickness** d_s (SI unit: m).

Magnetic Continuity

The **Magnetic Continuity** node does not apply any condition or constraint to the model. Its purpose is to allow the application of electrical boundary conditions by means of the subnodes [Electric Insulation](#) and [Contact Impedance](#). The subnodes are available from the context menu (right-click the parent node) or from the **Physics** toolbar, **Attributes** menu. Use this feature to model thin layer with particular electrical properties but with the same magnetic properties of the surrounding medium.



This node is available for 2D and 2D axisymmetric components. This node also can only be applied on domains where an Ampère’s Law feature is active.

The **RLC** (Resistive-Inductive-Capacitive) **Coil Group** node is an advanced coil feature that takes advantage of the A-V formulation of the Magnetic and Electric Fields features to take into account in-plane electric current flow in the coil’s current balance. This feature combines the magnetic model of a **Single Turn Coil** (in Coil group mode) with a multiple-terminal electrical model for the in-plane current. This node can be used to approximate in 2D a coil in which (due to capacitive coupling or other phenomena) there is relatively significant current flow in the in-plane directions.

Apply this feature to a group of domains representing the cross sections of the coil turns on the modeling plane. Since the electric potential is assumed to be constant in the cross section of each turn, the V variable must be removed in the selected domains by applying an **Ampère’s Law** node. The feature applies an external current density flowing orthogonally to the plane, and also imposes a voltage constraint on the boundary of each cross section, computed from the coil and the excitation properties. The feature also enforces a balance of the current flowing out-of-plane and the current leaking in the plane between the coil turns.



The approximation applied by this feature is valid only under the assumption that the current flowing in-plane is relatively small compared with the current in the coil. If this condition is not fulfilled, the model cannot be considered two-dimensional and a full 3D component is required.

DOMAINS LATTICE

In order to apply the correct voltage at each coil turn, it is necessary to precisely define the order in which the domains are connected. The RLC Coil Group feature assumes that all domains are of the same shape and are disposed on a two-dimensional *Bravais lattice*; that is, that there exist two vectors **a** and **b** (called *primitive vectors*) such that given two lattice points **r**₁ and **r**₂ the following relation holds:

$$\mathbf{r}_1 - \mathbf{r}_2 = n\mathbf{a} + m\mathbf{b}$$

with n and m being integers. One-dimensional lattices (linear lattices) are also supported by this feature.

The RLC Coil Group node can automatically determine two lattice vectors (or one, in the case of a linear lattice) from the geometry and position of the selected domains. The choices **Row-wise** and **Column-wise** in the **Ordering** settings use this functionality. The two choices control how the vectors **a** and **b** are chosen.

Since the primitive vectors of a Bravais lattice are not unique, the lattice recognition algorithm could find two vectors different from the desired one. In this case, it is possible to manually specify **User defined** lattice vectors.

DOMAIN ORDERING

By default, the RLC Coil Group feature assigns the first turn index (closest to the reference potential) to the turn with the smallest n and m . When using the automatic recognition algorithm, this usually corresponds to the coil turn with smallest x and y (or r and z in axisymmetry). The other coil turns are numbered in order of increasing m first, and then increasing n . Refer to the diagram in the node's **Settings** window for a visual explanation.

If **Winding** is set to **Alternated**, the direction of increasing m is reversed each time n changes value. Again, refer to the diagram for a visual explanation.

RESISTIVE-INDUCTIVE-CAPACITIVE COIL MODEL

The RLC Coil Group feature expands the model applied by a Single-Turn Coil domain feature by including a current balance for each turn and constraints for the voltage. The feature introduces $n+1$ voltages (where n is the number of coil turns) with the interpretation of electric potential values at the turn end terminals: V_0, V_1, \dots, V_n , where V_0 is the value specified as the **Ground voltage** in the **Settings** window. The cross section shown in the interface corresponds to the midsection of the turns, that is half way between the end terminals. The i -th coil turn ($i = 1, \dots, n$) has an applied potential difference

$$V_i^d = V_i - V_{i-1}$$

that drives an out-of-plane external current density computed as in the Single-Turn Coil case:

$$\mathbf{J}_e = \sigma \frac{V_i^d}{d} \mathbf{e}_z \quad \text{in 2D}$$

$$\mathbf{J}_e = \sigma \frac{V_i^d}{2\pi r} \mathbf{e}_\phi \quad \text{in 2D axisym.}$$

On the boundaries of the turn domain the electric potential variable V is constrained to the value $(V_i + V_{i-1})/2$, that is the mean of the electric potential values of its end terminals.

The current flowing in-plane is balanced with the difference of the currents between two adjacent turns. If I_i is the out-of-plane current flowing in the i -th turn,

$$I_i = \int_{\Omega_i} (\mathbf{J} \cdot \mathbf{e})$$

then the current balance for the coil turns is

$$I_i - \int_{\partial\Omega_i} (\mathbf{J} \cdot \mathbf{n}) - I_{i+1} = 0 \quad i = 1, \dots, n-1$$

$$I_n - \int_{\partial\Omega_n} (\mathbf{J} \cdot \mathbf{n}) - I_{\text{Coil}} = 0$$

The coil current I_{Coil} is computed from the coil excitation in the same way as for the Single-Turn Coil feature.

RLC COIL GROUP

The settings in this section is very similar to the ones described in the [Single-Turn Coil](#) node. The only addition is the **Ground voltage** input. Specify in the text box the voltage at one end of the coil (SI unit: V). The voltage at the other end depends on the excitation type. This setting is useful, for example, to connect in series two coil groups.

GEOMETRY

This section specifies the information needed to identify the Bravais lattice on which the coil turns are placed. The feature automatically detects the two primitive vectors of the lattice if **Ordering** is set as **Row-wise** (the default) or **Column-wise**. For **User defined** use the diagram as a guide to manually enter the **Primitive vectors a** and **b** (SI unit: m) of the lattice. The diagram shows how the domains are ordered for each choice.

Select a **Winding** style — **Regular** (the default) or **Alternated**. Look at the diagram for an illustration of these options.

Theory for the Magnetic Fields Interface

Simulation of magnetic fields is of interest when studying magnets, motors, transformers, and conductors carrying static or alternating currents.

The [Magnetic Fields Interface](#) is used for 3D, 2D in-plane, and 2D axisymmetric components. Unless you have a license for the AC/DC Module, only 2D components involving out-of-plane currents and axisymmetric components involving azimuthal currents are supported.



For a deeper theoretical background to the magnetic vector potential used, see the section starting with [Maxwell's Equations](#).

In this section:

- [Magnetostatics Equation](#)
- [Frequency Domain Equation](#)
- [Transient Equation](#)
- [Maxwell's Equations](#)
- [Magnetic and Electric Potentials](#)
- [Gauge Transformations](#)
- [Selecting a Particular Gauge](#)
- [The Gauge and Equation of Continuity for Dynamic Fields](#)
- [Explicit Gauge Fixing/Divergence Constraint](#)
- [Ungauged Formulations and Current Conservation](#)
- [Time-Harmonic Magnetic Fields](#)

Magnetostatics Equation

To derive the magnetostatic equation, start with Ampère's law for static cases $\nabla \times \mathbf{H} = \mathbf{J}$. The current is

$$\mathbf{J} = \sigma \mathbf{v} \times \mathbf{B} + \mathbf{J}_e$$

where \mathbf{J}_e is an externally generated current density, and \mathbf{v} is the velocity of the conductor.

Using the definitions of magnetic potential, $\mathbf{B} = \nabla \times \mathbf{A}$ and the constitutive relationship, $\mathbf{B} = \mu_0(\mathbf{H} + \mathbf{M})$, rewrite Ampère's law as

$$\nabla \times (\mu_0^{-1} \nabla \times \mathbf{A} - \mathbf{M}) - \sigma \mathbf{v} \times (\nabla \times \mathbf{A}) = \mathbf{J}_e$$

which is the equation used in magnetostatics.

The term involving the velocity only applies in the 2D and 2D axisymmetric formulations.

Frequency Domain Equation

To derive the time harmonic equation this physics interface solves, start with Ampère's law including displacement currents (then called Maxwell-Ampère's law), as these do not involve any extra computational cost in the frequency domain,

$$\nabla \times \mathbf{H} = \mathbf{J} + \frac{\partial \mathbf{D}}{\partial t} = \sigma \mathbf{E} + \sigma \mathbf{v} \times \mathbf{B} + \mathbf{J}_e + \frac{\partial \mathbf{D}}{\partial t}$$

Now assume time-harmonic fields and use the definitions of the fields,

$$\begin{aligned} \mathbf{B} &= \nabla \times \mathbf{A} \\ \mathbf{E} &= -j\omega \mathbf{A} \end{aligned}$$

and combine them with the constitutive relationships $\mathbf{B} = \mu_0(\mathbf{H} + \mathbf{M})$ and $\mathbf{D} = \epsilon_0 \mathbf{E}$ to rewrite Ampère's law as

$$(j\omega\sigma - \omega^2 \epsilon_0) \mathbf{A} + \nabla \times (\mu_0^{-1} \nabla \times \mathbf{A} - \mathbf{M}) - \sigma \mathbf{v} \times (\nabla \times \mathbf{A}) = \mathbf{J}_e$$

The term involving the velocity only applies in the 2D and 2D axisymmetric formulations.

Transient Equation

The transient equation this physics interface solves is Ampère's law, illustrated here with the constitutive relation $\mathbf{B} = \mu_0(\mathbf{H} + \mathbf{M})$.

$$\sigma \frac{\partial \mathbf{A}}{\partial t} + \nabla \times (\mu_0^{-1} \nabla \times \mathbf{A} - \mathbf{M}) - \sigma \mathbf{v} \times (\nabla \times \mathbf{A}) = \mathbf{J}_e$$

The term involving the velocity only applies in the 2D and 2D axisymmetric formulations.

Maxwell's Equations

Quasi-static analysis of magnetic and electric fields is valid under the assumption that $\partial \mathbf{D} / \partial t = 0$.

This implies that it is possible to rewrite Maxwell's equations in the following manner:

$$\begin{aligned}\nabla \times \mathbf{H} &= \mathbf{J} = \sigma(\mathbf{E} + \mathbf{v} \times \mathbf{B}) + \mathbf{J}_e \\ \nabla \times \mathbf{E} &= -\frac{\partial \mathbf{B}}{\partial t} \\ \nabla \cdot \mathbf{B} &= 0 \\ \nabla \cdot \mathbf{D} &= \rho \\ \nabla \cdot \mathbf{J} &= 0\end{aligned}$$

Here \mathbf{J}_e is an externally generated current density and \mathbf{v} is the velocity of the conductor. The crucial criterion for the quasi-static approximation to be valid is that the currents and electromagnetic fields vary slowly. This means that the dimensions of the structure in the problem need to be small compared to the wavelength.

Magnetic and Electric Potentials

Using the definitions of the potentials,

$$\begin{aligned}\mathbf{B} &= \nabla \times \mathbf{A} \\ \mathbf{E} &= -\nabla V - \frac{\partial \mathbf{A}}{\partial t}\end{aligned}$$

and the constitutive relation $\mathbf{B} = \mu_0(\mathbf{H} + \mathbf{M})$, Ampère's law can be rewritten as

$$\sigma \frac{\partial \mathbf{A}}{\partial t} + \nabla \times (\mu_0^{-1} \nabla \times \mathbf{A} - \mathbf{M}) - \sigma \mathbf{v} \times (\nabla \times \mathbf{A}) + \sigma \nabla V = \mathbf{J}_e \quad (5-3)$$

The equation of continuity, which is obtained by taking the divergence of the above equation, adds the following equation:

$$\nabla \cdot \left(-\sigma \frac{\partial \mathbf{A}}{\partial t} + \sigma \mathbf{v} \times (\nabla \times \mathbf{A}) - \sigma \nabla V + \mathbf{J}_e \right) = 0 \quad (5-4)$$

Equation 5-3 and Equation 5-4 form a system of equations for the two potentials \mathbf{A} and V .

Gauge Transformations

The electric and magnetic potentials are not uniquely defined from the electric and magnetic fields through

$$\mathbf{E} = -\frac{\partial \mathbf{A}}{\partial t} - \nabla V$$

$$\mathbf{B} = \nabla \times \mathbf{A}$$

Introducing two new potentials

$$\tilde{\mathbf{A}} = \mathbf{A} + \nabla \Psi$$

$$\tilde{V} = V - \frac{\partial \Psi}{\partial t}$$

gives the same electric and magnetic fields:

$$\mathbf{E} = -\frac{\partial \mathbf{A}}{\partial t} - \nabla V = -\frac{\partial(\tilde{\mathbf{A}} - \nabla \Psi)}{\partial t} - \nabla\left(\tilde{V} + \frac{\partial \Psi}{\partial t}\right) = -\frac{\partial \tilde{\mathbf{A}}}{\partial t} - \nabla \tilde{V}$$

$$\mathbf{B} = \nabla \times \mathbf{A} = \nabla \times (\tilde{\mathbf{A}} - \nabla \Psi) = \nabla \times \tilde{\mathbf{A}}$$

The variable transformation of the potentials is called a *gauge transformation*. To obtain a unique solution, choose the gauge — that is, put constraints on Ψ that make the solution unique. Another way of expressing this additional condition is to put a constraint on $\nabla \cdot \mathbf{A}$. A vector field is uniquely defined up to a constant if both $\nabla \cdot \mathbf{A}$ and $\nabla \times \mathbf{A}$ are given. This is called *Helmholtz's theorem*.

One particular gauge is the *Coulomb gauge* given by the constraint: $\nabla \cdot \mathbf{A} = 0$.

Selecting a Particular Gauge

It is important to observe that in the dynamic case, \mathbf{A} and V are coupled via the selected gauge. For a dynamic formulation, it is also possible to select a Ψ such that the scalar electric potential vanishes and only the magnetic vector potential has to be considered. The dynamic formulations (Frequency Domain and Time Dependent study types) of the Magnetic Fields interface are operated in this gauge as it involves only \mathbf{A} . The Magnetic and Electric Fields interface involves both \mathbf{A} and V and is inherently ungauged for all study types. In the static limit, \mathbf{A} and V are not coupled via

the gauge selection and thus any gauge can be chosen for \mathbf{A} when performing magnetostatic modeling.

The Gauge and Equation of Continuity for Dynamic Fields

After eliminating the electric potential by choosing the appropriate gauge and disregarding the velocity term, the equation of continuity obtained by taking the divergence of Ampère's law reads:

$$\nabla \cdot \left(-\sigma \frac{\partial \mathbf{A}}{\partial t} + \mathbf{J}_e \right) = 0$$

It is clear that unless the electrical conductivity is uniform, the particular gauge used to eliminate V cannot be the Coulomb gauge as that would violate the equation of continuity and would thereby also violate Ampère's law.

Explicit Gauge Fixing/Divergence Constraint

The AC/DC Module has a gauge fixing feature that is imposed by adding an extra scalar field variable ψ (not to be confused with Ψ used in the gauge transformation in [The Gauge and Equation of Continuity for Dynamic Fields](#)). The ψ field is used to impose a divergence constraint. In the most simple case, that is for magnetostatics, Ampère's law for the magnetic vector potential reads:

$$\nabla \times (\mu_0^{-1} \nabla \times \mathbf{A} - \mathbf{M}) = \mathbf{J}_e$$

The equation for ψ is used to impose the Coulomb gauge: $\nabla \cdot \mathbf{A} = 0$. However, to get a closed set of equations, ψ must be able to affect the first equation and this is obtained by modifying the first equation to:

$$\nabla \times (\mu_0^{-1} \nabla \times \mathbf{A} - \mathbf{M}) = \mathbf{J}_e + \nabla \psi$$

The additional term on the right-hand side can be seen as a Lagrange multiplier that not only imposes the Coulomb gauge but also eliminates any divergence in the externally generated current density, \mathbf{J}_e and makes it comply with the current continuity inherent in Ampère's law.

The gauge fixing feature similarly imposes the Coulomb gauge also for the dynamic (frequency domain) study type in the Magnetic and Electric Fields interface.

For the dynamic (Frequency Domain and Time Dependent study) types for the Magnetic Fields interface, the gauge is already determined so the gauge fixing feature is not allowed to impose the Coulomb gauge but reduces to help imposing current conservation. The first one is for the Frequency Domain study and the second one is for the Time Dependent study type:

$$\begin{aligned}\nabla \cdot \mathbf{J} &= 0 \\ \nabla \cdot (\sigma \mathbf{A}) &= 0\end{aligned}$$

The main benefit of using this kind of divergence constraint is improved numerical stability, especially when approaching the static limit when the inherent gauge deteriorates.

Ungauged Formulations and Current Conservation

Current conservation is inherent in Ampère’s law and it is known that if current is conserved, explicit gauge fixing is not necessary as iterative solvers converge towards a valid solution. However, it is generally not sufficient for the source currents to be divergence free in an analytical sense as when interpolated on the finite element functional basis, this property is not conserved.

When using the Magnetic and Electric Fields interface the electric potential is used to state current conservation so unless nonphysical current sources are specified inside the computational domain current conservation is fulfilled.

When using the Magnetic Fields interface, current conservation is usually imposed either by the solver (for magnetostatics) or in the transient or time harmonic case by the induced current density. The explicit gauge or divergence constraint can also help imposing current conservation as described in [Explicit Gauge Fixing/Divergence Constraint](#).

Time-Harmonic Magnetic Fields

In the time-harmonic case, there is no computational cost for including the displacement current in Ampère’s law (then called Maxwell-Ampère’s law):

$$\nabla \times \mathbf{H} = \mathbf{J} = \sigma(\mathbf{E} + \mathbf{v} \times \mathbf{B}) + (j\omega\mathbf{D} + \mathbf{J}_e)$$

In the transient case, the inclusion of this term leads to a second-order equation in time, but in the harmonic case there are no such complications. Using the definition of the electric and magnetic potentials, the system of equations becomes:

$$\begin{aligned}
-\nabla \cdot ((j\omega\sigma - \omega^2\varepsilon_0)\mathbf{A} - \sigma\mathbf{v} \times (\nabla \times \mathbf{A}) + (\sigma + j\omega\varepsilon_0)\nabla V - (\mathbf{J}_e + j\omega\mathbf{P})) &= 0 \\
(j\omega\sigma - \omega^2\varepsilon_0)\mathbf{A} + \nabla \times (\mu_0^{-1}\nabla \times \mathbf{A} - \mathbf{M}) - \sigma\mathbf{v} \times (\nabla \times \mathbf{A}) + (\sigma + j\omega\varepsilon_0)\nabla V &= \mathbf{J}_e + j\omega\mathbf{P}
\end{aligned}$$

The constitutive relation $\mathbf{D} = \varepsilon_0\mathbf{E} + \mathbf{P}$ has been used for the electric field.

To obtain a particular gauge that reduces the system of equation, choose $\Psi = -jV/\omega$ in the gauge transformation. This gives:

$$\tilde{\mathbf{A}} = \mathbf{A} - \frac{j}{\omega}\nabla V \qquad \tilde{V} = 0$$

When \tilde{V} vanishes from the equations, only the second one is needed,

$$(j\omega\sigma - \omega^2\varepsilon_0)\tilde{\mathbf{A}} + \nabla \times (\mu_0^{-1}\nabla \times \tilde{\mathbf{A}} - \mathbf{M}) - \sigma\mathbf{v} \times (\nabla \times \tilde{\mathbf{A}}) = \mathbf{J}_e + j\omega\mathbf{P}$$

Working with $\tilde{\mathbf{A}}$ is often the best option when it is possible to specify all source currents as external currents \mathbf{J}_e or as surface currents on boundaries.

Theory for the Magnetic Field Formulation Interface

The [Magnetic Field Formulation Interface](#) is used for 3D, 2D in-plane, and 2D axisymmetric components. The alternative formulation of the magnetic problem is particularly suitable to model materials having a highly nonlinear electric conductivity, such as superconductors. This section discusses the [Equation System](#).



For a deeper theoretical background to the magnetic vector potential used, see [Maxwell's Equations](#).

Equation System

To derive the equation system in this physics interface, start with Faraday's law:

$$\nabla \times \mathbf{E} = -\frac{\partial \mathbf{B}}{\partial t}$$

The electric field is computed from the current density, using an appropriate constitutive relation:

$$\mathbf{E} = \mathbf{E}_m(\mathbf{J} - \mathbf{J}_e) + \mathbf{v} \times \mathbf{B}$$

where \mathbf{J}_e is an externally generated current density, \mathbf{v} is the relative velocity of the domain in the physics interface's or node's frame, and $\mathbf{E}_m(\mathbf{J})$ is a (possibly nonlinear) relation sometimes called *E-J characteristic*, which describes the electric field in the local (material) frame as a function of the current density. The total current density \mathbf{J} is finally obtained from Ampère's Law:

$$\nabla \times \mathbf{H} = \mathbf{J}$$

Combining these equations give the first equation in the system applied by the Magnetic Field Formulation interface:

$$\nabla \times (\mathbf{E}_m(\mathbf{J} - \mathbf{J}_e) + \mathbf{v} \times \mathbf{B}) + \frac{\partial \mathbf{B}}{\partial t} = 0$$

This equation must be modified in different studies and according to the chosen constitutive relation. In stationary studies, the equation becomes:

$$\nabla \times (\mathbf{E}_m(\mathbf{J} - \mathbf{J}_e) + \mathbf{v} \times \mathbf{B}) = 0$$

while in frequency domain is:

$$\nabla \times (\mathbf{E}_m(\mathbf{J} - \mathbf{J}_e) + \mathbf{v} \times \mathbf{B}) + j\omega\mathbf{B} = 0$$



The term involving the velocity only applies in the 2D and 2D axisymmetric formulations.

The second equation in the system is the magnetic Gauss' law:

$$\nabla \cdot \mathbf{B} = 0$$

This equation is added with two purposes:

- Make the problem numerically stable when using curl elements. The feature adding this equation can only be applied when the magnetic field is discretized using curl elements, that is, in 3D components, and 2D or 2D axisymmetric components when the in-plane components are solved for.
- In magnetostatics, the magnetic flux density \mathbf{B} does not appear in the first equation. To allow modeling of magnetic materials and permanent magnets, it is necessary to include \mathbf{B} (with its constitutive relation) through the [Magnetic Gauss' Law](#) node.

E-J CHARACTERISTIC FOR THE ELECTRIC FIELD COMPUTATION

The $\mathbf{E}_m(\mathbf{J})$ characteristic introduced in the previous section can be specified in different ways in the [Faraday's Law](#) node. The most common case is a linear relation between \mathbf{E}_m and \mathbf{J} . In magnetostatics and in time-dependent studies (in the quasi-static approximation) this relation is specified by the resistivity or the electrical conductivity:

$$\mathbf{E}_m = \rho\mathbf{J}$$

$$\mathbf{E}_m = \sigma^{-1}\mathbf{J}$$

σ and ρ can be tensor quantities, in which case the inverse is intended as the inverse of a tensor. In frequency-domain, the displacement current is included, giving the following relations:

$$\mathbf{E}_m = ((\rho)^{-1} + j\omega\epsilon_0\epsilon_r)^{-1}\mathbf{J}$$

$$\mathbf{E}_m = (\sigma + j\omega\epsilon_0\epsilon_r)^{-1}\mathbf{J}$$

If the E-J characteristic is nonlinear, such in the case of a superconductor, the function can be expressed explicitly or as a material property.



Superconducting Wire: Application Library path

ACDC_Module/Other_Industrial_Applications/superconducting_wire

Theory for the Magnetic Fields, No Currents Interface

In magnetostatic problems where no electric currents are present, it is possible to formulate and solve the problem using a scalar magnetic potential. In a current-free region you have $\nabla \times \mathbf{H} = \mathbf{0}$. This implies that the magnetic scalar potential V_m can be defined from the relation $\mathbf{H} = -\nabla V_m$, which is analogous to the definition of the electric potential for static electric fields.

Using the constitutive relation $\mathbf{B} = \mu_0(\mathbf{H} + \mathbf{M})$, the equation $\nabla \cdot \mathbf{B} = 0$ becomes

$$-\nabla \cdot (\mu_0 \nabla V_m - \mu_0 \mathbf{M}) = 0 \quad (5-5)$$

[The Magnetic Fields, No Currents Interface](#) uses this equation for modeling of magnetostatics in the absence of electric currents.

In planar 2D the dynamic formulations also involves the thickness d in the z direction:

$$-\nabla \cdot d(\mu_0 \nabla V_m - \mu_0 \mathbf{M}) = 0$$



For a discussion about the boundary element method used with [The Magnetic Fields, No Currents, Boundary Elements Interface](#), see [Theory for the Boundary Elements PDE](#) in the *COMSOL Multiphysics Reference Manual*.

Theory for the Magnetic and Electric Fields Interface

The [Magnetic and Electric Fields Interface](#) can be used for modeling full coupling between electric and magnetic fields. Use this physics interface for 3D, 2D in-plane, and 2D axisymmetric components. For a deeper theoretical background to the magnetic vector potential and electric scalar potential used below, see the [Theory for the Magnetic Fields Interface](#).



The Magnetic and Electric Currents interface only supports the stationary and frequency domain study types — that is, there is no transient formulation available.

In this section:

- [Magnetostatics Equations](#)
- [Frequency Domain Equations](#)

Magnetostatics Equations

To derive the magnetostatics equations, start with Ampère’s law for static cases: $\nabla \times \mathbf{H} = \mathbf{J}$. Define the potentials,

$$\begin{aligned}\mathbf{B} &= \nabla \times \mathbf{A} \\ \mathbf{E} &= -\nabla V\end{aligned}$$

and the current

$$\mathbf{J} = \sigma \mathbf{v} \times \mathbf{B} - \sigma \nabla V + \mathbf{J}_e$$

where \mathbf{J}_e is an externally generated current density, and \mathbf{v} is the velocity of the conductor.

Add the constitutive relationship, $\mathbf{B} = \mu_0(\mathbf{H} + \mathbf{M})$, and rewrite Ampère’s law as

$$\nabla \times (\mu_0^{-1} \nabla \times \mathbf{A} - \mathbf{M}) - \sigma \mathbf{v} \times (\nabla \times \mathbf{A}) + \sigma \nabla V = \mathbf{J}_e$$

The equation of continuity is obtained by taking the divergence of Ampère's law. It is the equation solved for the electric potential. Thus the following equations for V and \mathbf{A} apply:

$$\begin{aligned} -\nabla \cdot (-\sigma \mathbf{v} \times (\nabla \times \mathbf{A}) + \sigma \nabla V - \mathbf{J}_e) &= 0 \\ \nabla \times (\mu_0^{-1} \nabla \times \mathbf{A} - \mathbf{M}) - \sigma \mathbf{v} \times (\nabla \times \mathbf{A}) + \sigma \nabla V &= \mathbf{J}_e \end{aligned}$$

Frequency Domain Equations

To derive the time harmonic equation this physics interface solves, start with Maxwell-Ampère's law including displacement current (then called Maxwell-Ampère's law). Including this does not involve any extra computational cost in the frequency domain. Assume time-harmonic fields

$$\nabla \times \mathbf{H} = \mathbf{J} = \sigma(\mathbf{E} + \mathbf{v} \times \mathbf{B}) + (j\omega \mathbf{D} + \mathbf{J}_e)$$

and use the definitions of the fields,

$$\begin{aligned} \mathbf{B} &= \nabla \times \mathbf{A} \\ \mathbf{E} &= -\nabla V - j\omega \mathbf{A} \end{aligned}$$

and combine them with the constitutive relationships $\mathbf{B} = \mu_0(\mathbf{H} + \mathbf{M})$ and $\mathbf{D} = \epsilon_0 \mathbf{E} + \mathbf{P}$ to rewrite Ampère's law as

$$(j\omega\sigma - \omega^2 \epsilon_0) \mathbf{A} + \nabla \times (\mu_0^{-1} \nabla \times \mathbf{A} - \mathbf{M}) - \sigma \mathbf{v} \times (\nabla \times \mathbf{A}) + (\sigma + j\omega \epsilon_0) \nabla V - j\omega \mathbf{P} = \mathbf{J}_e$$

The equation of continuity is again obtained by taking the divergence of Ampère's law. It is the equation solved for the electric potential. Thus the following equations for V and \mathbf{A} apply:

$$\begin{aligned} -\nabla \cdot ((j\omega\sigma - \omega^2 \epsilon_0) \mathbf{A} - \sigma \mathbf{v} \times (\nabla \times \mathbf{A}) + (\sigma + j\omega \epsilon_0) \nabla V - (\mathbf{J}_e + j\omega \mathbf{P})) &= 0 \\ (j\omega\sigma - \omega^2 \epsilon_0) \mathbf{A} + \nabla \times (\mu_0^{-1} \nabla \times \mathbf{A} - \mathbf{M}) - \sigma \mathbf{v} \times (\nabla \times \mathbf{A}) + (\sigma + j\omega \epsilon_0) \nabla V - j\omega \mathbf{P} &= \mathbf{J}_e \end{aligned}$$



The Electrical Circuit Interface

The Electrical Circuit interface, found under the **AC/DC** branch () when adding interfaces, has the equations for modeling electrical circuits with or without connections to a distributed fields model, solving for the voltages, currents and charges associated with the circuit elements.

In this chapter:

- [The Electrical Circuit Interface](#)
- [Theory for the Electrical Circuit Interface](#)

The Electrical Circuit Interface

The **Electrical Circuit (cir)** interface () , found under the **AC/DC** branch () when adding a physics interface, is used to model currents and voltages in circuits including voltage and current sources, resistors, capacitors, inductors, and semiconductor devices. Models created with the Electrical Circuit interface can include connections to distributed field models. The physics interface supports stationary, frequency-domain and time-domain modeling and solves Kirchhoff's conservation laws for the voltages, currents and charges associated with the circuit elements.

When this physics interface is added, it adds a default **Ground Node** feature and associates that with node zero in the electrical circuit.



Circuit nodes are nodes in the electrical circuit (electrical nodes) and should not be confused with nodes in the Model Builder tree of the COMSOL Multiphysics software. Circuit node names are not restricted to numerical values but can contain alphanumeric characters.



Inductor in an Amplifier Circuit: Application Library path
ACDC_Module/Inductive_Devices_and_Coils/inductor_in_circuit

DEVICE NAMES

Each circuit component has an associated **Device name**, which is constructed from a prefix identifying the type of the device and a string. The string can be specified in the feature's **Settings** window. The **Device name** is used to identify variables defined by the component, and for the SPICE Import and Export functionality.

SETTINGS

The **Label** is the default physics interface name.

The **Name** is used primarily as a scope prefix for variables defined by the physics interface. Refer to such physics interface variables in expressions using the pattern `<name>.<variable_name>`. In order to distinguish between variables belonging to different physics interfaces, the **name** string must be unique. Only letters, numbers, and underscores (`_`) are permitted in the **Name** field. The first character must be a letter.

The default **Name** (for the first physics interface in the model) is `cir`.

RESISTANCE IN PARALLEL TO PN JUNCTIONS

For numerical stability, a large resistance is added automatically in parallel to the pn junctions in diodes and BJT devices. Enter a default value for the **Resistance in parallel to pn junctions** R_j (SI unit: Ω). The default value is $1 \cdot 10^{12} \Omega$.

CREATE UNIQUE NODES FOR NEW DEVICES

When this setting is selected (the default), newly added devices will be assigned unused node names. The devices will be disconnected from the rest of the circuit and the nodes should be updated to reflect the actual circuit connections. When this setting is deselected, new devices will be connected to the lowest-numbered nodes starting from 0.



- [Theory for the Electrical Circuit Interface](#)
 - [Connecting to Electrical Circuits](#)
-

ELECTRICAL CIRCUIT TOOLBAR

The following nodes are available from the **Electrical Circuit** ribbon toolbar (Windows users), **Electrical Circuit** context menu (Mac or Linux users), or right-click to access the context menu (all users):



For step-by-step instructions and general documentation descriptions, this is the **Electrical Circuit** toolbar.

- Ground Node
- Voltmeter
- Ampère Meter
- Resistor
- Capacitor
- Inductor
- Voltage Source
- Current Source
- Diode
- Voltage-Controlled Voltage Source¹
- Voltage-Controlled Current Source¹
- Current-Controlled Voltage Source¹
- Current-Controlled Current Source¹
- Subcircuit Definition
- Subcircuit Instance
- Mutual Inductance
- Transformer
- NPN BJT and PNP BJT²
- n-Channel MOSFET and p-Channel MOSFET²
- External I vs. U³
- External U vs. I³
- External I-Terminal³
- SPICE Circuit Import
- SPICE Circuit Export

¹ Selected from the **Dependent Sources** submenu when you right-click main node.

² Selected from the **Transistors** submenu when you right-click main node.

³ Selected from the **External Couplings** submenu when you right-click main node.

Ground Node

The **Ground Node** () feature adds a ground node with the default node number zero to the electrical circuit. This is the default node in the Electrical Circuit interface. More ground nodes can be added but those must have unique node numbers and are by default given higher node numbers.

GROUND CONNECTION

Set the **Node name** for the ground node in the circuit. The convention is to use 0 (zero) for the ground node. If adding more ground nodes, each must have a unique node name (number).

Voltmeter

The **Voltmeter** () feature connects a voltmeter (voltage measurement device) between two nodes in the electrical circuit. A voltmeter behaves electrically as an open circuit. The voltmeter node adds a Probe sampling the voltage across it.

DEVICE NAME

Enter a **Device name** for the voltmeter. The name is also used in the probe.

NODE CONNECTIONS

Set the two **Node names** for the connecting nodes for the resistor.

Ampère Meter

The **Ammeter** () feature connects an ammeter (current measurement device) between two nodes in the electrical circuit. An ammeter behaves electrically as a short circuit. The ammeter node adds a Probe sampling the current through it.

DEVICE NAME

Enter a Device name for the ammeter. The name is also used in the probe.

NODE CONNECTIONS

Set the two **Node names** for the connecting nodes for the resistor.

DEVICE PARAMETERS

Enter the **Resistance** of the resistor.

Resistor

The **Resistor** () feature connects a resistor between two nodes in the electrical circuit.

DEVICE NAME

Enter a **Device name** for the resistor. The prefix is R.

NODE CONNECTIONS

Set the two **Node names** for the connecting nodes for the resistor.

DEVICE PARAMETERS

Enter the **Resistance** of the resistor.

Capacitor

The **Capacitor** () feature connects a capacitor between two nodes in the electrical circuit.

DEVICE NAME

Enter a **Device name** for the capacitor. The prefix is C.

NODE CONNECTIONS

Set the two **Node names** for the connecting nodes for the capacitor.

DEVICE PARAMETERS

Enter the **Capacitance** of the capacitor.

Inductor

The **Inductor** () feature connects an inductor between two nodes in the electrical circuit.

DEVICE NAME

Enter a Device name for the inductor. The prefix is L.

NODE CONNECTIONS

Set the two **Node names** for the connecting nodes for the inductor.

DEVICE PARAMETERS

Enter the **Inductance** of the inductor.

Voltage Source

The **Voltage Source** () feature connects a voltage source between two nodes in the electrical circuit.

DEVICE NAME

Enter a **Device name** for the voltage source. The prefix is V.

NODE CONNECTIONS

Set the two **Node names** for the connecting nodes for the voltage source. The first node represents the positive reference terminal.

DEVICE PARAMETERS

Enter the **Source type** that should be adapted to the selected study type. It can be **DC-source**, **AC-source**, or a time-dependent **Sine source** or **Pulse source**. Depending on the choice of source, also specify the following parameters:

- For a DC-source, the **Voltage V_{src}** (default value: 1 V). DC-sources are active in Stationary and Time-Dependent studies.
- For an AC-source: the **Voltage V_{src}** (default value: 1 V) and the **Phase Θ** (default value: 0 rad). AC-sources are active in Frequency Domain studies only.
- For a sine source: the **Voltage V_{src}** (default value: 1 V), the **Offset V_{off}** (default value: 0 V), the **Frequency** (default value: 1 kHz), and the **Phase Θ** (default value: 0 rad). The sine sources are active in Time-Dependent studies and also in Stationary studies, providing that a value for t has been provided as a model parameter or global variable.
- For a pulse source: the **Voltage V_{src}** (default value: 1 V), the **Offset V_{off}** (default value: 0 V), the **Delay t_d** (default value: 0s), the **Rise time t_r** and **Fall time t_f** (default values: 0 s), the **Pulse width p_w** (default value: 1 μs), and the **Period T_{per}** (default value: 2 μs). The pulse sources are active in Time-Dependent studies and also in Stationary studies, providing that a value for t has been provided as a model parameter or global variable.

All values are peak values rather than RMS.



For the AC source, the frequency is a global input set by the solver. AC sources should be used in Frequency-domain studies only. Do not use the **Sine source** unless the model is time-dependent.

Current Source

The **Current Source** () feature connects a current source between two nodes in the electrical circuit.

DEVICE NAME

Enter a **Device name** for the current source. The prefix is I.

NODE CONNECTIONS

Set the two **Node names** for the connecting nodes for the current source. The first node represents the positive reference terminal from where the current flows through the source to the second node.

DEVICE PARAMETERS

Enter the **Source type** that should be adapted to the selected study type. It can be **DC-source**, **AC-source**, or a time-dependent **Sine source** or **Pulse source**. Depending on the choice of source, also specify the following parameters:

- For a DC-source, the **Current i_{src}** (default value: 1 A). DC-sources are active in Stationary and Time-Dependent studies.
- For an AC-source: the **Current i_{src}** (default value: 1 A) and the **Phase Θ** (default value: 0 rad). AC-sources are active in Frequency Domain studies only.
- For a sine source: the **Current i_{src}** (default value: 1 A), the **Offset i_{off}** (default value: 0 A), the **Frequency** (default value: 1 kHz), and the **Phase Θ** (default value: 0 rad). The sine sources are active in Time-Dependent studies and also in Stationary studies, providing that a value for t has been provided as a model parameter or global variable.
- For a pulse source: the **Current i_{src}** (default value: 1 A), the **Offset i_{off}** (default value: 0 A), the **Delay t_d** (default value: 0 s), the **Rise time t_r** and **Fall time t_f** (default values: 0 s), the **Pulse width p_w** (default value: 1 μ s), and the **Period T_{per}** (default value: 2 μ s). The pulse sources are active in Time-Dependent studies and also in Stationary studies, providing that a value for t has been provided as a model parameter or global variable.

All values are peak values rather than RMS.



For the AC source, the frequency is a global input set by the solver. AC sources should be used in frequency-domain studies only. Do not use the **Sine source** unless the model is time-dependent.

Voltage-Controlled Voltage Source

The **Voltage-Controlled Voltage Source** () feature connects a voltage-controlled voltage source between two nodes in the electrical circuit. A second pair of nodes define the input control voltage.

DEVICE NAME

Enter a **Device name** for the voltage-controlled voltage source. The prefix is E.

NODE CONNECTIONS

Specify four **Node names**: the first pair for the connection nodes for the voltage source and the second pair defining the input control voltage. The first node in a pair represents the positive reference terminal.

DEVICE PARAMETERS

Enter the voltage **Gain**. The resulting voltage is this number multiplied by the control voltage.

Voltage-Controlled Current Source

The **Voltage-Controlled Current Source** () feature connects a voltage-controlled current source between two nodes in the electrical circuit. A second pair of nodes define the input control voltage.

DEVICE NAME

Enter a **Device name** for the voltage-controlled current source. The prefix is G.

NODE CONNECTIONS

Specify four **Node names**: the first pair for the connection nodes for the current source and the second pair defining the input control voltage. The first node in a pair represents the positive voltage reference terminal or the one from where the current flows through the source to the second node.

DEVICE PARAMETERS

Enter the source **Gain** (SI units: S). The resulting current is this number multiplied by the control voltage. It represents the transconductance of the source.

Current-Controlled Voltage Source

The **Current-Controlled Voltage Source** () feature connects a current-controlled voltage source between two nodes in the electrical circuit. The input control current is the one flowing through a two-pin device.

DEVICE NAME

Enter a **Device name** for the current-controlled voltage source. The prefix is H.

NODE CONNECTIONS

Set two **Node names** for the connection nodes for the voltage source. The first node in a pair represents the positive reference terminal.

DEVICE PARAMETERS

Enter the voltage **Gain** and select the **Device** whose current is taken as the control current. The resulting voltage is this number multiplied by the control current through the named **Device** (any two-pin device). Thus it formally has the unit of resistance.

Current-Controlled Current Source

The **Current-Controlled Current Source** () feature connects a current-controlled current source between two nodes in the electrical circuit. The input control current is the one flowing through a named device that must be a two-pin device.

DEVICE NAME

Enter a **Device name** for the current-controlled current source. The prefix is F.

NODE CONNECTIONS

Specify two **Node names** for the connection nodes for the current source. The first node in a pair represents the positive reference terminal from where the current flows through the source to the second node.

DEVICE PARAMETERS

Enter the current **Gain** and select the **Device** whose current is taken as the control current. The resulting current is this number multiplied by the control current through the **Device**.

Subcircuit Definition

The **Subcircuit Definition** () feature is used to define subcircuits, which can be inserted as devices into the main circuit using **Subcircuit Instance** nodes. Create the subcircuit by adding subnodes to the **Subcircuit Definition** node, either by using the **Physics** toolbar, or by right-clicking the **Subcircuit Definition**.

SUBCIRCUIT PINS

Define the **Pin names** at which the subcircuit connects to the main circuit or to other subcircuits when referenced by a **Subcircuit Instance** node. The **Pin names** refer to circuit nodes in the subcircuit. The order in which the **Pin names** are defined is the

order in which they are referenced by a Subcircuit Instance node. The devices constituting the subcircuit should be connected only to the subcircuit's pins and to themselves.

Subcircuit Instance

The **Subcircuit Instance** () feature represents an instance of a subcircuits defined by a [Subcircuit Definition](#) feature.



DEVICE NAME

Enter a **Device name** for the subcircuit instance. The prefix is X.

NODE CONNECTIONS

Select the **Name of subcircuit link** from the list of defined subcircuits in the circuit model and the circuit **Node names** at which the subcircuit instance connects to the main circuit or to another subcircuit if used therein.

NPN BJT and PNP BJT

The **NPN BJT** () and the **PNP BJT** () device models are large-signal models for bipolar junction transistors (BJT). It is an advanced device model and no thorough description and motivation of the many input parameters are attempted here. Many device manufacturers provide model input parameters for this BJT model. For any particular make of BJT, the device manufacturer should be the primary source of information.

DEVICE NAME

Enter a **Device name** for the BJT. The prefix is Q.

NODE CONNECTIONS

Specify three **Node names** for the connection nodes for the **BJT** device. These represent the *collector*, *base*, and *emitter* nodes for the **NPN** transistor, and the *emitter*, *base*, and *collector* nodes for the **PNP** transistor.

MODEL PARAMETERS



Specify the **Model Parameters**. Reasonable defaults are provided but for any particular BJT, the device manufacturer should be the primary source of information.



The interested reader is referred to [Ref. 1](#) for more details on semiconductor modeling within circuits.

For an explanation of the **Model Parameters** see [Bipolar Transistors](#).

n-Channel MOSFET and p-Channel MOSFET

The **n-Channel MOSFET** () and the **p-Channel MOSFET** () device models are large-signal models for, respectively, an n-Channel MOS field-effect transistor (MOSFET) and p-Channel MOSFET. These are advanced device models and no thorough description and motivation of the many input parameters are attempted here. Many device manufacturers provide model parameters for the MOSFET models. For any particular make of MOSFET, the device manufacturer should be the primary source of information.

DEVICE NAME

Enter a **Device name** for the MOSFET. The prefix is M.

NODE CONNECTIONS

Specify four **Node names** for the connection nodes for the **n-Channel MOSFET** or **p-Channel MOSFET** device. These represent the *drain*, *gate*, *source*, and *bulk* nodes, respectively.

MODEL PARAMETERS

Specify the **Model Parameters**. Reasonable defaults are provided but for any particular MOSFET, the device manufacturer should be the primary source of information.



The interested reader is referred to [Ref. 1](#) for more details on semiconductor modeling within circuits.

For an explanation of the **Model Parameters** see [MOSFET Transistors](#).

Mutual Inductance

The **Mutual Inductance** allows specifying a coupling between two existing **Inductor** features in the circuit. The mutual inductance of the coupling is

$$M = k\sqrt{L_1L_2}$$

where k is the coupling factor and L_1 and L_2 are the inductances of the inductors.

DEVICE PARAMETERS

Enter values or expressions for the:

- **Coupling factor** k (dimensionless). The value must be between 0 and 1, and the default is 0.98.
- **First inductance** L_1 (SI unit: H) and **Second inductance** L_2 (SI unit: H). These must be set to two different **Inductor** features in the circuit.

Transformer

The **Transformer** feature represents either a combination of two **Inductor** and a **Mutual Inductance** features, or an ideal transformer.

NODE CONNECTIONS

Enter or edit the table in the **Node names** column for the **primary** and **secondary** node connections.

DEVICE PARAMETERS

Choose a **Transformer model** — **Specify inductors** (the default) or **Ideal transformer**.

For **Specify inductors** enter values or expressions for the:

- **Coupling factor** k (dimensionless). The default is 0.98.
- **First inductance** L_1 (SI unit: H). The default is 1 mH.
- **Second inductance** L_2 (SI unit: H). The default is 1 mH.

For **Ideal transformer** enter values or expressions for the **Winding ratio** N_1/N_2 (dimensionless). The default is 10.

Diode

The **Diode** device model () is a large-signal model for a diode. It is an advanced device model and no thorough description and motivation of the many input parameters are attempted here. The interested reader is referred to [Ref. 1](#) for more details on semiconductor modeling within circuits. Many device manufacturers provide model parameters for this diode model. For any particular make of diode, the device manufacturer should be the primary source of information.

DEVICE NAME

Enter a **Device name** for the diode. The prefix is D.

NODE CONNECTIONS

Specify two **Node names** for the positive and negative nodes for the **Diode** device.

MODEL PARAMETERS

Specify the **Model Parameters**. Reasonable defaults are provided but for any particular diode, the device manufacturer should be the primary source of information.



For an explanation of the **Model Parameters** see [Diode](#).

External I vs. U

The **External I vs. U** () feature connects an arbitrary voltage measurement (for example, a circuit terminal or circuit port boundary or a coil domain from another physics interface) as a voltage source between two nodes in the electrical circuit. The resulting circuit current from the first node to the second node is typically coupled back as a prescribed current source in the context of the voltage measurement.

DEVICE NAME

Enter a **Device name** for the External I vs. U node.

NODE CONNECTIONS

Specify the two **Node names** for the connecting nodes for the voltage source. The first node represents the positive reference terminal.

EXTERNAL DEVICE

Enter the source of the **Voltage**. If circuit or current excited terminals or circuit ports are defined on boundaries or domains or a multiturn coil domains is defined in other physics interfaces, these display as options in the **Voltage** list. Also select the **User defined** option and enter your own voltage variable, for example, using a suitable coupling operator. For inductive or electromagnetic wave propagation models, the voltage measurement must be performed as an integral of the electric field because the electric potential only does not capture induced EMF. Also the integration must be performed over a distance that is short compared to the local wavelength.



Except when coupling to a circuit terminal, circuit port, or coil, the current flow variable must be manually coupled back in the electrical circuit to the context of the voltage measurement. This applies also when coupling to a current excited terminal. The name of this current variable follows the convention `cirn.IvsUm_i`, where `cirn` is the tag of the Electrical Circuit interface node and `IvsUm` is the tag of the **External I vs. U** node. The tags are typically displayed within curly brackets `{}` in the Model Builder.



[Nonlocal Couplings and Coupling Operators in the COMSOL Multiphysics Reference Manual](#)

External U vs. I

The **External U vs. I** () feature connects an arbitrary current measurement (for example, a coil domain from another physics interface) as a current source between two nodes in the electrical circuit. The resulting circuit voltage between the first node and the second node is typically coupled back as a prescribed voltage source in the context of the current measurement.

DEVICE NAME

Enter a **Device name** for the External U vs. I node.

NODE CONNECTIONS

Specify the two **Node names** for the connecting nodes for the current source. The current flows from the first node to the second node.

EXTERNAL DEVICE

Enter the source of the **Current**. Voltage excited terminals or lumped ports defined on boundaries in other physics interfaces are natural candidates but do not appear as options in the **Voltage** list because those do not have an accurate built-in current measurement variable. A **User defined** option must be selected and a current variable entered, for example, using a suitable coupling operator.



The voltage variable must be manually coupled back in the electrical circuit to the context of the current measurement. This applies also when coupling to a voltage excited terminal or lumped port. The name of this voltage variable follows the convention `cirn.UvsIm_v`, where `cirn` is the tag of the Electrical Circuit interface node and `UvsIm` is the tag of the **External U vs. I** node. The tags are typically displayed within curly brackets `{ }` in the Model Builder.



[Nonlocal Couplings and Coupling Operators in the COMSOL Multiphysics Reference Manual](#)

External I-Terminal

The **External I-Terminal** () feature connects an arbitrary voltage-to-ground measurement (for example, a circuit terminal from another physics interface) as a voltage-to-ground assignment to a node in the electrical circuit. The resulting circuit current from the node is typically coupled back as a prescribed current source in the context of the voltage measurement. This node does not apply when coupling to inductive or electromagnetic wave propagation models because then voltage must be defined as a line integral between two points rather than a single point measurement of electric potential. For such couplings, use the **External I vs. U** node instead.

DEVICE NAME

Enter a **Device name** for the External I-terminal.

NODE CONNECTIONS

Set the **Node name** for the connecting node for the voltage assignment.

EXTERNAL TERMINAL

Enter the source of the **Voltage**. If circuit- or current-excited terminals are defined on boundaries in other physics interfaces, these display as options in the **Voltage** list. Also select the **User defined** option and enter a voltage variable, for example, using a suitable coupling operator.



Except when coupling to a circuit terminal, the current flow variable must be manually coupled back in the electrical circuit to the context of the voltage measurement. This applies also when coupling to a current excited terminal. The name of this current variable follows the convention `cirn.termIm_i`, where `cirn` is the tag of the Electrical Circuit interface node and `termIm` is the tag of the **External I-Terminal** node. The tags are typically displayed within curly brackets `{ }` in the Model Builder.



[Nonlocal Couplings and Coupling Operators](#) in the *COMSOL Multiphysics Reference Manual*.



SPICE Circuit Import

Right-click the **Electrical Circuit** () feature node to import an existing SPICE netlist (select **Import Spice Netlist**). A window opens — enter a file location or browse your directories to find one. The default file extension for a SPICE netlist is `.cir`. The SPICE circuit import translates the imported netlist into Electrical Circuit interface nodes so these define the subset of SPICE features that can be imported.



See [SPICE Import and Export](#) about the supported SPICE commands.

SPICE Circuit Export

Right-click the **Electrical Circuit** () feature node to export the current circuit to the SPICE netlist file format (select **Export Spice Netlist** ). A window opens — enter a

file location or browse your directories to find one. The default file extension for a SPICE netlist is `.cir`. The compatible circuit nodes are exported as SPICE devices



See [SPICE Export](#) for more details on the supported SPICE commands.

Theory for the Electrical Circuit Interface

The [Electrical Circuit Interface](#) theory is discussed in this section:

- [Electric Circuit Modeling and the Semiconductor Device Models](#)
- [Bipolar Transistors](#)
- [MOSFET Transistors](#)
- [Diode](#)
- [Reference for the Electrical Circuit Interface](#)



[Connecting to Electrical Circuits](#)

Electric Circuit Modeling and the Semiconductor Device Models

Electrical circuit modeling capabilities are useful when simulating all sorts of electrical and electromechanical devices ranging from heaters and motors to advanced plasma reactors in the semiconductor industry. There are two fundamental ways that an electrical circuit model relates to a physical field model.

- The field model is used to get a better, more accurate description of a single device in the electrical circuit model.
- The electrical circuit is used to drive or terminate the device in the field model in such a way that it makes more sense to simulate both as a tightly coupled system.

The Electrical Circuit interface makes it possible to add nodes representing circuit elements directly to the Model Builder tree in a COMSOL Multiphysics model. The circuit variables can then be connected to a physical device model to perform co-simulations of circuits and multiphysics. The model acts as a device connected to the circuit so that its behavior is analyzed in larger systems.

The fundamental equations solved by the Electrical Circuit interface are Kirchhoff's circuit laws, which in turn can be deduced from Maxwell's equations. The supported study types are Stationary, Frequency Domain, and Time Dependent.

There are three more advanced large-signal semiconductor device features available in the Electrical Circuit interface. The equivalent circuits and the equations defining their non-ideal circuit elements are described in this section. For a more complete treatise on semiconductor device modeling see [Ref. 1](#).

Bipolar Transistors

Figure 6-1 illustrates the equivalent circuit for the npn bipolar junction transistor.

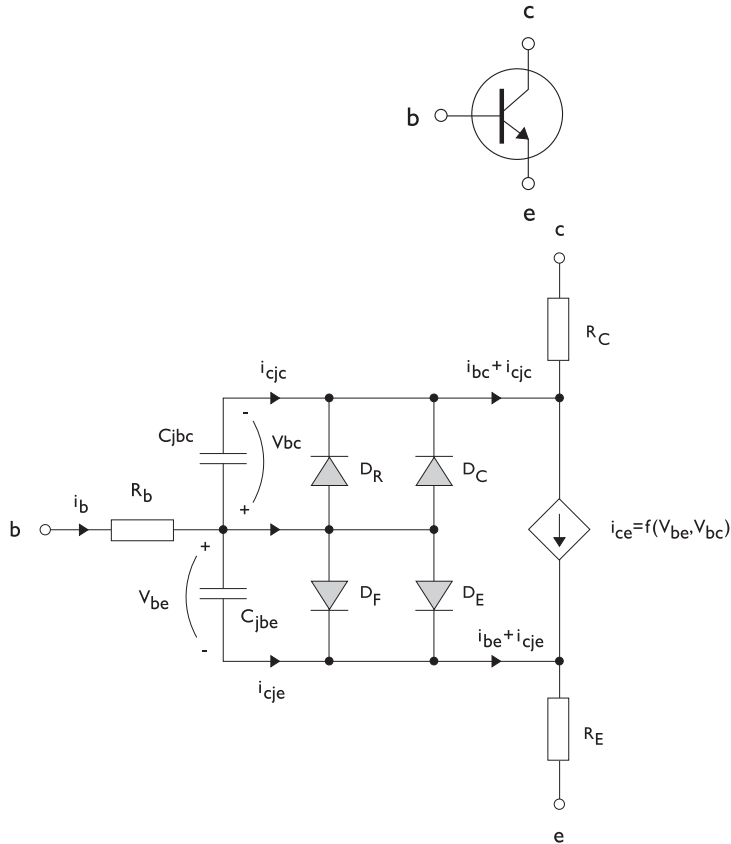

Figure 6-1: A circuit for the bipolar transistor.

The pnp transistor model is similar in all regards to the npn transistor, with the difference that the polarities of the currents and voltages involved are reversed. The following equations are used to compute the relations between currents and voltages in the circuit.

$$v_{rb} = \frac{1}{A} \left(R_{BM} - \frac{R_B - R_{BM}}{f_{bq}} \right) i_b$$

$$f_{bq} = \frac{1}{2 \left(1 - \frac{v_{bc}}{V_{AF}} - \frac{v_{be}}{V_{AR}} \right)} \left(1 + \sqrt{1 + 4I_S \left(\frac{e^{\frac{v_{be}}{N_F V_T}} - 1}{I_{KF} A} + \frac{e^{\frac{v_{bc}}{N_R V_T}} - 1}{I_{KR} A} \right)} \right)$$

$$i_{be} = A \left(\frac{I_S}{B_F} \left(e^{\frac{v_{be}}{N_F V_T}} - 1 \right) + I_{SE} \left(e^{\frac{v_{be}}{N_E V_T}} - 1 \right) \right)$$

$$i_{bc} = A \left(\frac{I_S}{B_R} \left(e^{\frac{v_{bc}}{N_R V_T}} - 1 \right) + I_{SC} \left(e^{\frac{v_{bc}}{N_C V_T}} - 1 \right) \right)$$

$$i_{ce} = A \left(\frac{I_S}{f_{bq}} \left(e^{\frac{v_{be}}{N_F V_T}} + e^{\frac{v_{bc}}{N_C V_T}} \right) \right)$$

$$V_T = \frac{k_B T_{NOM}}{q}$$

There are also two capacitances that use the same formula as the junction capacitance of the diode model. In the parameter names below, replace x with C for the base-collector capacitance and E for the base-emitter capacitance.

$$C_{jbx} = AC_{Jx} \times \begin{cases} \left(1 - \frac{v_{bx}}{V_{Jx}} \right)^{-M_{Jx}} & v_{bx} < F_C V_{Jx} \\ (1 - F_C)^{-1 - M_{Jx}} \left(1 - F_C (1 + M_{Jx}) + M_{Jx} \frac{v_{bx}}{V_{Jx}} \right) & v_{bx} \geq F_C V_{Jx} \end{cases}$$

The model parameters are listed in the table below.

TABLE 6-1: BIPOLAR TRANSISTOR MODEL PARAMETERS

PARAMETER	DEFAULT	DESCRIPTION
B_F	100	Ideal forward current gain
B_R	1	Ideal reverse current gain
C_{JC}	0 F/m ²	Base-collector zero-bias depletion capacitance
C_{JE}	0 F/m ²	Base-emitter zero-bias depletion capacitance
F_C	0.5	Breakdown current
I_{KF}	Inf (A/m ²)	Corner for forward high-current roll-off

TABLE 6-1: BIPOLAR TRANSISTOR MODEL PARAMETERS

PARAMETER	DEFAULT	DESCRIPTION
I_{KR}	Inf (A/m ²)	Corner for reverse high-current roll-off
I_S	1e-15 A/m ²	Saturation current
I_{SC}	0 A/m ²	Base-collector leakage saturation current
I_{SE}	0 A/m ²	Base-emitter leakage saturation current
M_{JC}	1/3	Base-collector grading coefficient
M_{JE}	1/3	Base-emitter grading coefficient
N_C	2	Base-collector ideality factor
N_E	1.4	Base-emitter ideality factor
N_F	1	Forward ideality factor
N_R	1	Reverse ideality factor
R_B	0 Ωm^2	Base resistance
R_{BM}	0 Ωm^2	Minimum base resistance
R_C	0 Ωm^2	Collector resistance
R_E	0 Ωm^2	Emitter resistance
T_{NOM}	298.15 K	Device temperature
V_{AF}	Inf (V)	Forward Early voltage
V_{AR}	Inf (V)	Reverse Early voltage
V_{JC}	0.71 V	Base-collector built-in potential
V_{JE}	0.71 V	Base-emitter built-in potential

MOSFET Transistors

Figure 6-2 illustrates an equivalent circuit for the n-channel MOSFET transistor. The p-channel MOSFET transistor is treated similarly, but the polarities of the involved voltages are reversed.

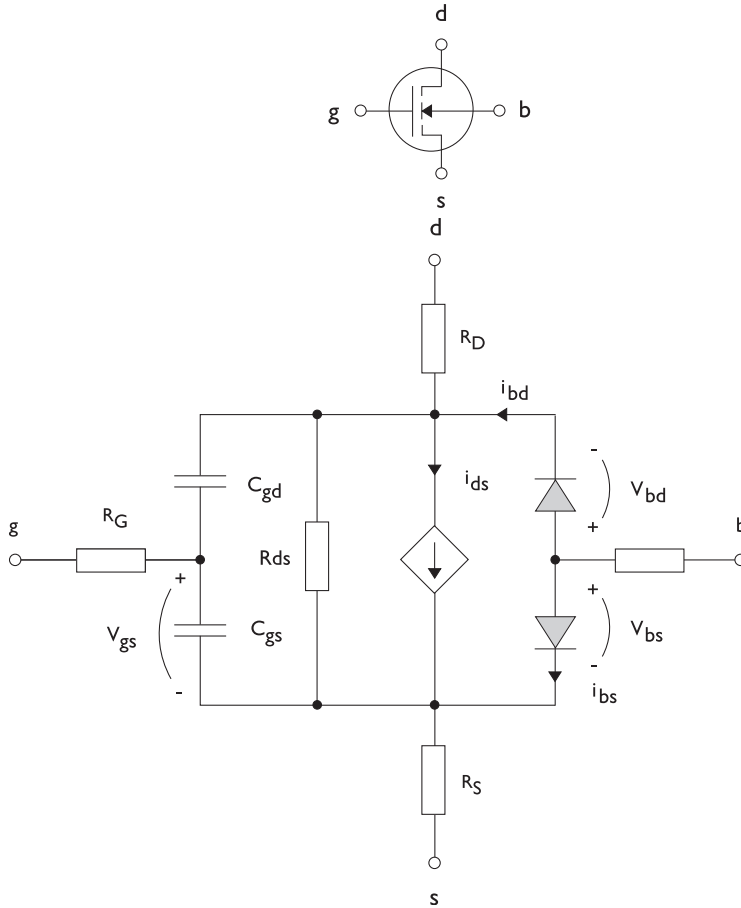

Figure 6-2: A circuit for the MOSFET transistor.

The following equations are used to compute the relations between currents and voltages in the circuit.

$$i_{ds} = \begin{cases} \frac{WK_P}{L} \frac{1 + \Lambda v_{ds}}{2} v_{ds} (2v_{th} - v_{ds}) & v_{ds} < v_{th} \\ \frac{WK_P}{L} \frac{1 + \Lambda v_{ds}}{2} v_{th}^2 & v_{ds} \geq v_{th} \\ 0 & v_{ds} < v_{th} \leq 0 \end{cases}$$

$$v_{th} = v_{gs} - (V_{TO} + \Gamma(\sqrt{\Phi} - v_{bs} - \sqrt{\Phi}))$$

$$i_{bd} = I_S \left(e^{\frac{v_{bd}}{NV_T}} - 1 \right)$$

$$i_{bs} = I_S \left(e^{\frac{v_{bs}}{NV_T}} - 1 \right)$$

$$V_T = \frac{k_B T_{NOM}}{q}$$

There are also several capacitances between the terminals

$$C_{gd} = C_{gd0} W$$

$$C_{gs} = C_{gs0} W$$

$$C_{jbd} = C_{BD} \times \begin{cases} \left(1 - \frac{v_{bd}}{P_B}\right)^{-M_J} & v_{bx} < F_C P_B \\ (1 - F_C)^{-1 - M_J} \left(1 - F_C(1 + M_J) + M_J \frac{v_{bx}}{P_B}\right) & v_{bx} \geq F_C P_B \end{cases}$$

The model parameters are as follows:

TABLE 6-2: MOSFET TRANSISTOR MODEL PARAMETERS

PARAMETER	DEFAULT	DESCRIPTION
C_{BD}	0 F/m	Bulk-drain zero-bias capacitance
C_{GDO}	0 F/m	Gate-drain overlap capacitance
C_{GSO}	0 F/m	Gate-source overlap capacitance
F_C	0.5	Capacitance factor
I_S	1e-13 A	Bulk junction saturation current
K_P	2e-5 A/V ²	Transconductance parameter
L	50e-6 m	Gate length
M_J	0.5	Bulk junction grading coefficient

TABLE 6-2: MOSFET TRANSISTOR MODEL PARAMETERS

PARAMETER	DEFAULT	DESCRIPTION
N	1	Bulk junction ideality factor
P_B	0.75 V	Bulk junction potential
R_B	0 Ω	Bulk resistance
R_D	0 Ω	Drain resistance
R_{DS}	Inf (Ω)	Drain-source resistance
R_G	0 Ω	Gate resistance
R_S	0 Ω	Source resistance
T_{NOM}	298.15 K	Device temperature
V_{TO}	0 V	Zero-bias threshold voltage
W	50e-6 m	Gate width
Γ (GAMMA)	1 $\text{V}^{0.5}$	Bulk threshold parameter
Φ (PHI)	0.5 V	Surface potential
Λ (LAMBDA)	0 1/V	Channel-length modulation

Diode

Figure 6-3 illustrates equivalent circuit for the diode.

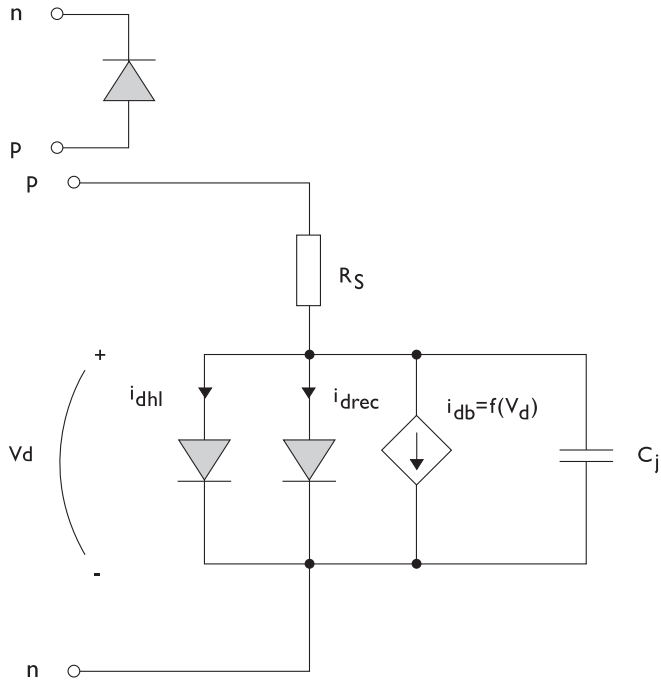

Figure 6-3: A circuit for the diode.

The following equations are used to compute the relations between currents and voltages in the circuit.

$$i_d = i_{dhl} + i_{drec} + i_{db} + i_c$$

$$i_{dhl} = I_S \left(e^{\frac{v_d}{NV_T}} - 1 \right) \frac{1}{\sqrt{1 + \frac{I_S}{I_{KF}} \left(e^{\frac{v_d}{NV_T}} - 1 \right)}}$$

$$i_{drec} = I_{SR} \left(e^{\frac{v_d}{N_R V_T}} - 1 \right)$$

$$i_{db} = I_{BV} e^{\frac{v_d + B_V}{N_{BV} V_T}}$$

$$C_j = C_{J0} \times \begin{cases} \left(1 - \frac{v_d}{V_J} \right)^{-M} & v_d < F_C V_J \\ (1 - F_C)^{-1-M} \left(1 - F_C (1 + M) + M \frac{v_d}{V_J} \right) & v_d \geq F_C V_J \end{cases}$$

$$V_T = \frac{k_B T_{NOM}}{q}$$

where the following model parameters are required

TABLE 6-3: DIODE TRANSISTOR MODEL PARAMETERS

PARAMETER	DEFAULT	DESCRIPTION
B_V	Inf (V)	Reverse breakdown voltage
C_{J0}	0 F	Zero-bias junction capacitance
F_C	0.5	Forward-bias capacitance coefficient
I_{BV}	1 e-09 A	Current at breakdown voltage
I_{KF}	Inf (A)	Corner for high-current roll-off
I_S	1 e-13 A	Saturation current
M	0.5	Grading coefficient
N	1	Ideality factor
N_{BV}	1	Breakdown ideality factor
N_R	2	Recombination ideality factor
R_S	0 Ω	Series resistance
T_{NOM}	298.15 K	Device temperature
V_J	1.0 V	Junction potential

Reference for the Electrical Circuit Interface

1. P. Antognetti and G. Massobrio, *Semiconductor Device Modeling with Spice*, 2nd ed., McGraw-Hill, 1993.

Heat Transfer Interfaces

The AC/DC Module license includes a physics interface found under the **AC/DC>Electromagnetic Heating** or **Heat Transfer>Electromagnetic Heating** branch (). This physics interface combines magnetic fields with heat transfer for modeling of electromagnetic heating such as induction heating. [The Induction Heating Interface](#) is discussed in this chapter.

The Induction Heating Interface

The **Induction Heating** interface () is used to model induction heating and eddy current heating. This multiphysics interface adds a Magnetic Fields interface and a Heat Transfer in Solids interface. The multiphysics couplings add the electromagnetic power dissipation as a heat source, and the electromagnetic material properties can depend on the temperature.

Depending on the licensed products, stationary modeling and time-domain modeling are supported in 2D and 3D. In addition, combinations of frequency-domain modeling for the Magnetic Fields interface and stationary modeling for the Heat Transfer in Solids interface, called frequency-stationary and, similarly, frequency-transient modeling, are supported.

When a predefined **Induction Heating** interface is added from the **AC/DC>Electromagnetic Heating** or **Heat Transfer>Electromagnetic Heating** branch () of the **Model Wizard** or **Add Physics** windows, **Magnetic Fields** and **Heat Transfer in Solids** interfaces are added to the Model Builder. A **Multiphysics Couplings** node is also added, which automatically includes the multiphysics coupling feature **Electromagnetic Heating**.

On the Constituent Physics Interfaces

The Magnetic Fields interface is used to compute magnetic field and induced current distributions in and around s , conductors and magnets. Depending on the licensed products, stationary, frequency-domain, and time-domain formulations are supported in 2D and 3D. Note that the frequency and time domain formulations become ill-posed when approaching the static limit. One may extend the useful frequency range downward by adding a low electric conductivity. The Magnetic Fields interface solves Maxwell's equations formulated using the magnetic vector potential and, optionally for s , the scalar electric potential as the dependent variables.

The Heat Transfer in Solids interface provides features for modeling heat transfer by conduction, convection, and radiation. A Heat Transfer in Solids model is active by default on all domains. All functionality for including other domain types, such as a fluid domain, is also available. The temperature equation defined in solid domains

corresponds to the differential form of Fourier's law that may contain additional contributions like heat sources.



In previous versions of COMSOL Multiphysics, a specific physics interface called Induction Heating was added to the Model Builder. Now, a predefined multiphysics coupling approach is used, improving the flexibility and design options for your modeling. For specific details, see [Multiphysics Modeling Workflow](#) in the *COMSOL Multiphysics Reference Manual*.

SETTINGS FOR PHYSICS INTERFACES AND COUPLING FEATURE

When physics interfaces are added using the predefined couplings, for example **Induction Heating**, specific settings are included with the physics interfaces and the coupling features.

However, if physics interfaces are added one at a time, followed by the coupling features, these modified settings are not automatically included.

For example, if single **Magnetic Fields** and **Heat Transfer in Solids** interfaces are added, COMSOL Multiphysics adds an empty **Multiphysics Couplings** node. You can choose **Electromagnetic Heating** from the available coupling features but the modified settings are not included.



Coupling features are available from the context menu (right-click the **Multiphysics Couplings** node) or from the **Physics** toolbar, **Multiphysics** menu.

TABLE 7-1: MODIFIED SETTINGS FOR AN INDUCTION HEATING INTERFACE

PHYSICS INTERFACE OR COUPLING FEATURE	MODIFIED SETTINGS (IF ANY)
Magnetic Fields	No changes.
Heat Transfer in Solids	No changes.
Electromagnetic Heating	<p>The Domain Selection is the same as that of the participating physics interfaces.</p> <p>The Boundary Selection is the same as the exterior and interior boundaries of the Domain Selection of the participating physics interfaces.</p> <p>The corresponding Magnetic Fields and Heat Transfer in Solids interfaces are preselected in the Coupled Interfaces section.</p>



A side effect of adding physics interfaces one at a time is that four study types — Frequency-Stationary, Frequency-Transient, Frequency-Stationary, One-Way Coupled, Electromagnetic Heating, and Frequency-Transient, One-Way Coupled, Electromagnetic Heating — are not available for selection until *after* at least one coupling feature is added. In this case, it is better to initially not add any study at all, then add the coupling features to the **Multiphysics** node, and lastly, open the **Add Study** window and add a study sequence below the **Preset Studies for Selected Multiphysics** heading.

PHYSICS INTERFACES AND COUPLING FEATURE



Use the online help in COMSOL Multiphysics to locate and search all the documentation. All these links also work directly in COMSOL Multiphysics when using the Help system.

Coupling Feature

The [Electromagnetic Heating](#) coupling feature node is described in this section.

Physics Interface Features

Physics nodes are available from the **Physics** ribbon toolbar (Windows users), **Physics** context menu (Mac or Linux users), or right-click to access the context menu (all users).



In general, to add a node, go to the **Physics** toolbar, no matter what operating system you are using. Subnodes are available by clicking the parent node and selecting it from the **Attributes** menu.

- The available physics features for [The Magnetic Fields Interface](#) are listed in the section [Domain, Boundary, Point, and Pair Nodes for the Magnetic Fields Interface](#).
- See [The Heat Transfer Interfaces](#) in the *COMSOL Multiphysics Reference Manual* for information about the available physics features for heat transfer.



Inductive Heating of a Copper Cylinder: Application Library path **ACDC_Module/Electromagnetic_Heating/inductive_heating**



See [The Heat Transfer Interfaces](#) and [The Joule Heating Interface](#) in the *COMSOL Multiphysics Reference Manual* for other Heat Transfer interface and feature node settings.

Electromagnetic Heating

The **Electromagnetic Heating** multiphysics coupling node represents the electromagnetic losses, Q_e (SI unit: W/m^3), as a heat source in the heat transfer part of the model. It is given by

$$Q_e = Q_{rh} + Q_{ml}$$

where the resistive losses are

$$Q_{rh} = \frac{1}{2} \text{Re}(\mathbf{J} \cdot \mathbf{E}^*)$$

and the magnetic losses are

$$Q_{ml} = \frac{1}{2} \text{Re}(i\omega \mathbf{B} \cdot \mathbf{H}^*)$$

In addition, it maps the electromagnetic surface losses as a heat source on the boundary (SI unit: W/m^2) in the heat transfer part of the model.

SETTINGS

The **Label** is the default multiphysics coupling name.

The **Name** is used primarily as a scope prefix for variables defined by the coupling node. Refer to such variables in expressions using the pattern `<name>.<variable_name>`. In order to distinguish between variables belonging to different coupling nodes or physics interfaces, the `name` string must be unique. Only letters, numbers, and underscores (`_`) are permitted in the **Name** field. The first character must be a letter.

The default **Name** (for the first multiphysics coupling in the model) is `emh1`.

DOMAIN SELECTION

When nodes are added from the context menu, you can select **Manual** (the default) from the **Selection** list to choose specific domains to define the electromagnetic heat source or select **All domains** as needed.

When **Electromagnetic Heating** is added as an effect of adding an **Induction Heating** interface, the selection is the same as for the participating interfaces.

Only domains that are active in the physics interfaces selected in the **Coupled Interfaces** section can be selected.

BOUNDARY SELECTION

When nodes are added from the context menu, you can select **Manual** (the default) from the **Selection** list to choose specific boundaries to define the electromagnetic boundary heat source or select **All boundaries** as needed.

When **Electromagnetic Heating** is added as an effect of adding an **Induction Heating** interface, the selection is the same as the exterior and interior boundaries of the **Domain Selection** of the participating physics interfaces.

Only boundaries that are active in the physics interfaces selected in the **Coupled Interfaces** section can be selected.

COUPLED INTERFACES

This section defines the physics involved in the **Electromagnetic Heating** multiphysics coupling. By default, the applicable physics interface is selected in the **Electromagnetic** list to apply the **Heat transfer** to its physics interface to establish the coupling.

You can also select **None** from either list to uncouple the **Electromagnetic Heating** node from a physics interface. If the physics interface is removed from the **Model Builder**, for example **Heat Transfer in Solids** is deleted, then the **Heat transfer** list defaults to **None** as there is nothing to couple to.



If a physics interface is deleted and then added to the model again, and in order to reestablish the coupling, you need to choose the physics interface again from the **Heat transfer** or **Electromagnetic** lists. This is applicable to all multiphysics coupling nodes that would normally default to the once present physics interface. See [Multiphysics Modeling Workflow](#) in the *COMSOL Multiphysics Reference Manual*.

Glossary

This [Glossary of Terms](#) contains finite element modeling terms in an electromagnetics context. For mathematical terms as well as geometry and CAD terms specific to the COMSOL Multiphysics® software and documentation, see the glossary in the *COMSOL Multiphysics Reference Manual*. For references to more information about a term, see the index.

Glossary of Terms

anisotropy Variation of material properties with direction.

constitutive relation The relation between the \mathbf{D} and \mathbf{E} fields and between the \mathbf{B} and \mathbf{H} fields. These relations depend on the material properties.

eddy currents Induced currents normal to a time-varying magnetic flux in a ferromagnetic material.

edge element See *vector element*.

electric dipole See *electric currents point dipole*, *electrostatics point dipole*, and *magnetic fields electric dipole*.

electric currents point dipole Two equal and opposite point current sources $+q$ and $-q$ separated a short distance d . The electric current dipole moment is given by $\mathbf{p} = q\mathbf{d}$, where \mathbf{d} is a vector going from $-q$ to $+q$.

electrostatics point dipole Two equal and opposite charges $+q$ and $-q$ separated a short distance d . The electric dipole moment is given by $\mathbf{p} = q\mathbf{d}$, where \mathbf{d} is a vector going from $-q$ to $+q$.

gauge transformation A variable transformation of the electric and magnetic potentials that leaves Maxwell's equations invariant.

magnetic dipole A small circular loop carrying a current. The magnetic dipole moment is $\mathbf{m} = IA\mathbf{e}$, where I is the current carried by the loop, A its area, and \mathbf{e} a unit vector along the central axis of the loop.

magnetic fields electric dipole The limiting case when the length d of a current filament carrying uniform current I approaches zero while maintaining the product between I and d .

Nedelec's edge element See *vector element*.

phasor A complex function of space representing a sinusoidally varying quantity.

quasi-static approximation The electromagnetic fields are assumed to vary slowly, so that the retardation effects can be neglected. This approximation is valid when the geometry under study is considerably smaller than the wavelength.

vector element A finite element often used for electromagnetic vector fields. The tangential component of the vector field at the mesh edges is used as a degree of freedom. Also called *Nedelec's edge element* or just *edge element*.

I n d e x

- A**
 - adiabatic assumption 70
 - air stress tensors
 - electromagnetics 50
 - moving bodies 54
 - ammeter (node) 347
 - Ampère's law (node) 238, 242
 - Ampère's law and current conservation (node) 324
 - anisotropic materials 39
 - Application Libraries window 25
 - application library examples
 - AC/DC materials 72
 - boundary conditions 69
 - Cartesian coordinates 67
 - connecting electrical circuits to physics interfaces 108
 - contact impedance 170
 - dielectric shielding node 130
 - effective nonlinear magnetic curves 42
 - electric currents 155
 - electric shielding 169
 - electrical circuits 108, 344
 - electromagnetic forces 75
 - electrostatics 118
 - homogenized multi-turn coil 79
 - induction heating 374
 - magnetic and electric fields 318
 - magnetic field formulation 284, 339
 - magnetic fields 235
 - magnetic fields, no currents 291
 - rotating machinery, magnetic 311
 - single conductor coil 79
 - single-turn coil domain 87
 - stress tensors 50
 - symmetries 68–69
 - terminal node 133
 - thin low permittivity gap 129
 - total forces 51
 - vector hysteresis modeling 45, 242
 - applying, electromagnetic sources 69
 - Archie's law (node) 141
 - automatic current calculation (node) 263
 - axial symmetry, cylindrical coordinates 67
- B**
 - base node 353
 - bipolar junction transistor 353
 - boundary conditions
 - electromagnetics theory 39
 - forced voltage, port 96
 - boundary current source (node) 163, 187
 - boundary feed (node) 270
 - boundary group (node) 272
 - boundary nodes
 - electric currents 155
 - electric currents, shell 194
 - electrostatics 119
 - magnetic and electric fields 321
 - magnetic field formulation 284
 - magnetic fields 236
 - magnetic fields, no currents 291
 - Brinell hardness 227
 - bulk node 354
- C**
 - calculating
 - electromagnetic forces 46, 75
 - forces in moving objects 53
 - S-parameters 107
 - capacitance matrix, fixed charge 97
 - capacitance matrix, forced voltage 96
 - capacitor (node) 347
 - Cartesian coordinates 22, 66
 - cementation exponent 141, 223

- change cross-section (node) 139
- change shell thickness (node) 197
- change thickness (out-of-plane) (node) 139
- charge conservation (node) 121, 148
- charge conservation, piezoelectric (node) 139
- charge relaxation theory 215
- circuit import, SPICE 359
- circular coil 88
- coenergy 55
- coil (node) 252
- coil geometry (node) 259
- coil wires inlet/outlet (node) 262
- coil, single-turn 267
- collector node 353
- common settings 22
- conduction loss (time-harmonic) (node) 122
- conductive media 229
- conductor model (coil) 252
- connected boundaries (node) coil 266–267
- constitutive relations theory 33–34
- contact impedance (node) 169
- continuum mechanics forces 46
- Cooper-Mikic-Yovanovich (CMY) correlation 226
- Coulomb gauge 333
- coupling, to the electrical circuits interface 109
- curl elements 338
- curl shape functions 250
- current conservation (node) electric currents 158 electric currents, shell 195
- current conservation, ungauged formulations 335
- current source (node) electric currents 161 electric currents, shell 197 electrical circuits 349
- current sources, theory 217
- current-controlled current source (node) 352
- current-controlled voltage source (node) 351
- cylindrical coordinates 22, 67

D

- device models, electrical circuits 362
- dielectric shielding (node) 130
- dielectrics and perfect conductors 40
- diode (node) 356
- diode transistor model 368
- dispersive materials 39
- distributed capacitance (node) 135
- distributed impedance (node) 164
- documentation 23
- domain group (node) 272
- domain nodes electric currents 155 electrostatics 119 magnetic and electric fields 321 magnetic field formulation 284 magnetic fields 236 magnetic fields, no currents 291
- drain node 354

E

- edge current (node) 276
- edge nodes electric currents 155 electric currents, shell 194 electrostatics 119 magnetic and electric fields 321
- effective medium (node) 142
- E-J characteristic 337
- elastic material stress tensor electromagnetics 52

- moving bodies 55
- elastic pure conductor 52, 54
- electric coenergy 55
- electric currents in layered shells 190
- electric currents in shells 178
- electric currents interface 153
 - theory 224
- electric currents solid to shell via boundary 213
- electric currents, layered shell interface 199
- electric currents, shell interface 191
 - theory 229
- electric displacement field (node) 128
- electric field (node) 287
- electric field transformation (node) 313
- electric fields theory 214
- electric forces and torques 57
- Electric Insulation 265
- electric insulation (node)
 - electric currents 161
- electric point dipole (node)
 - electric currents 175
 - magnetic fields 250
- electric point dipole (on axis) (node) 176
- electric potential (node) 126, 149
- electric scalar-scalar potential coupling (node) 151
- electric shielding (node)
 - electric currents 168
 - electric currents, shell 198
- electrical circuit interface 344
 - theory 361
- electrical circuits
 - modeling techniques 108
- electrical conductivity, porous media 222
- electrical contact (node) 171
- electrical size 65
- electromagnetic energy, theory 36
- electromagnetic forces and torques 74
- electromagnetic forces, calculating 46
- electromagnetic heating (node) 375
- electromagnetic quantities 59
- electromagnetic sources, applying 69
- electromagnetic stress tensors 50
- electrostatic point dipole (node) 140
- electrostatics interface 116
 - theory 214
- electrostatics, boundary elements interface 143
- emailing COMSOL 25
- emitter node 353
- equation of continuity 215
- error message, electrical circuits 109
- exporting
 - SPICE netlists 113
- external current density (node)
 - electric currents 160
 - magnetic fields 244
- external I vs. U (node) 356
- external I-terminal (node) 358
- external magnetic flux density (node) 296
- external magnetic vector potential (node) 276
- external surface charge accumulation (node) 127
- external U vs. I (node) 357

F

- Faraday's law 337
- Faraday's law (node) 286
- field variables in 2D 71
- file, Touchstone 98
- fixed current, ports 96
- floating potential (node)
 - electric currents 162
 - electrostatics 133, 149
 - single-turn coil 271

- fluid saturation 141
- force calculation (node) 124
- forced voltage, port 96
- forces
 - calculating 74
 - continuum mechanics and 46
 - elastic solids, and 48
 - electromagnetic, calculating 46
 - in moving objects 53
 - stationary fields 49
 - torque 49
- formation factor 223
- frequency domain study 225
 - force calculation and 124
 - theory, electric currents 217
- G** Galilei invariants and transformations 53
- gap feed (node) 270
- gate node 354
- gauge fixing 334
- gauge fixing for A-field (node) 250
- gauge transformation 333
- Gauss' law and charge relaxation theory 215
- Gauss' law equation 218
- general elastic materials
 - electromagnetics 52
 - moving bodies 55
- geometry, simplifying 66
- ground (node) 125, 149
- ground (node), single-turn coil domain 271
- ground node (node) 346
- H** harmonic perturbation (node), global 259
- Helmholtz's theorem 333
- homogenized multi-turn (coil) 253
- homogenized shell 209
- homogenized shell connection 209
- I** impedance boundary condition (node) 276
- importing
 - SPICE netlists 112, 359
- induction heating interface 372
- inductor (node) 348
- inhomogeneous materials 39
- initial values (node)
 - electric currents 160
 - electric currents, shell 197
 - electrostatics 123
 - magnetic and electric fields 324
 - magnetic field formulation 286
 - magnetic fields 244
 - magnetic fields, no currents 294
 - magnetic fields, no currents, boundary elements 304
 - rotating machinery, magnetic 312
- input (node), coil 261
- input (node), coil domains 263
- interface current source 188, 212
- interlayer connection 188, 208
- internet resources 23
- J** Jiles-Atherton model 42
- Jiles-Atherton, hysteresis 42
- K** Kirchhoff's circuit laws 361
- knowledge base, COMSOL 26
- L** layer current source 211
- layered shell 187, 207
- line charge (node) 135
- line charge (on axis) (node) 136
- line charge (out-of-plane) (node) 137
- line current (on axis) (node) 249
- line current (out-of-plane) (node) 249
- line current source (node) 173
- line current source (on axis) (node) 173
- linear coil 88

- Lorentz force equation 38
- Lorentz forces, calculating 74
- Lorentz term 38
- lumped element (node) 275
- lumped parameters
 - converting 99
 - energy method 97
 - fixed current 96
 - Ohm's law and 95
 - studying 98
- lumped port (node) 272
- lumped ports 103
- M** magnetic and electric fields interface 315
 - theory 341
- magnetic coenergy 55
- magnetic continuity (node) 326
- magnetic field (node) 247
- magnetic field formulation interface 282
 - theory 337
- magnetic fields interface 232
 - theory 330
- magnetic fields, no currents interface 289
 - theory 340
- magnetic flux conservation (node) 293
 - magnetic fields, no currents, boundary elements 303
- magnetic flux density (node) 295
 - magnetic fields, no currents, boundary elements 305
- magnetic forces and torques 56
- magnetic Gauss' law 338
- magnetic Gauss' law (node) 286
- magnetic insulation (node)
 - magnetic and electric fields 325
 - magnetic currents 245
 - magnetic field formulation 287
 - magnetic fields, no currents 294
 - magnetic fields, no currents, boundary elements 304
- magnetic point dipole (node) 279
- magnetic point dipole (on axis) (node) 280
- magnetic potential (node) 248
- magnetic scalar potential (node) 294
 - magnetic fields, no currents, boundary elements 304
- magnetic scalar potential discontinuity (node)
 - magnetic fields, no currents 297
- magnetic scalar-scalar potential coupling (node)
 - magnetic fields, no currents, boundary elements 305
- magnetic shielding (node)
 - magnetic and electric fields 325
 - magnetic currents 280
 - magnetic fields, no currents 296
- magnetic vector-scalar potential coupling (node)
 - magnetic fields, no currents, boundary elements 306
- magnetostatics, no currents, boundary elements interface (node)
 - magnetic fields, no currents, boundary elements 299
- material properties
 - electromagnetics 39
- Maxwell capacitance 99
- Maxwell stress tensor, calculating 74
- Maxwell's equations
 - dielectrics 40
 - electrical circuits and 361
 - quasi-static approximation 332
 - theory 32
- mesh resolution 72
- method of virtual work 55

- Mikic elastic correlation 227
- mixed formulation boundary (node) 314
- MPH-files 25
- multiphysics couplings
 - induction heating 372
- multi-turn, homogenized (coil) 253
- mutual capacitance matrix 100
- mutual inductance (node) 355
- N**
 - n-Channel MOS transistor 354, 365
 - n-Channel MOSFET (node) 354
 - netlists, SPICE 112, 359
 - nodes, common settings 22
 - nonlinear materials 39
 - normal current density (node)
 - electric currents 164
 - electric currents, shell 198
 - NPN bipolar junction transistor 362
 - NPN BJT (node) 353
 - numeric coil 89
- O**
 - Ohm's law and charge relaxation theory
 - 215
 - output (node), coil 262
 - output (node), coil domains 264
- P**
 - pair contact impedance (node) 169
 - pair electrical contact (node) 171
 - pair nodes
 - electric currents 155
 - electric currents, shell 194
 - electrostatics 119
 - magnetic field formulation 284
 - magnetic fields 236
 - magnetic fields, no currents 291
 - pair thin low permeability gap (node) 297
 - p-Channel MOS transistor 354
 - p-Channel MOSFET (node) 354
 - PDE formulations 35
 - perfect conductors and dielectrics 40
 - perfect magnetic conductor (node) 248
 - periodic condition (node) 128
 - phasors 40
 - physics interface guide 17
 - physics interfaces, common settings 22
 - PMC. see perfect magnetic conductor.
 - PNP BJT (node) 353
 - point charge (node) 137
 - point charge (on axis) (node) 138
 - point current source (node) 174
 - point current source (on axis) (node)
 - 174
 - point dipoles, magnetic 279
 - point nodes
 - electric currents 155
 - electric currents, shell 194
 - electrostatics 119
 - magnetic and electric fields 321
 - magnetic field formulation 284
 - magnetic fields 236
 - magnetic fields, no currents 291
 - ports, lumped 103
 - potentials, scalar and magnetic 35
 - power law, porous media
 - conductivity 220
 - permeability 222
 - permittivity 221
 - Poynting's theorem 37
 - predefined couplings, electrical circuits
 - 109
 - prescribed rotation (node) 313
 - prescribed rotational velocity (node) 313
 - principle of virtual displacement 55
 - pure conductor stress tensor 52, 54
- Q**
 - quasi-static approximation 38, 332
- R**
 - reciprocal permeability, volume average
 - 222
 - reciprocal permittivity, volume average

- 221
 - resistance matrix 100
 - resistor (node) 347
 - RLC coil group (node) 327
 - robust geometry analysis method (coil)
 - 88
 - rotating machinery, magnetic interface
 - 308
 - S**
 - saturation coefficient 223
 - saturation exponent 141
 - scattering parameters. *see* S-parameters
 - sector symmetry (node) 172
 - selecting
 - solvers 73
 - space dimensions 66
 - study types 70
 - semiconductor device models 362
 - shape functions 250
 - single conductor (coil) 252
 - single-turn coil (node) 267
 - skin effects 72
 - solver settings 73
 - solving models 66
 - source node 354
 - space charge density (node) 123
 - space dimension, solving models and 66
 - space dimensions, selecting 66
 - S-parameter calculations
 - electric field, and 106
 - SPICE
 - exporting 113
 - SPICE capacitance matrix 99
 - SPICE netlists 112, 359
 - standard settings 22
 - stationary fields, forces 49
 - stationary source sweep (node) 101
 - stress tensors 54
 - electromagnetics 52
 - moving bodies 55
 - study types
 - electric currents 225
 - electromagnetic theory 35
 - physics interface availability 21
 - selecting 70
 - subcircuit definition (node) 352
 - subcircuit instance (node) 353
 - surface charge density (node) 126, 150
 - surface current (node)
 - magnetic and electric fields 325
 - magnetic currents 247
 - surface magnetic current density (node)
 - 248, 288
 - sweeps and lumped parameters 98
 - symmetry specification (coil) 88
- T**
 - technical support, COMSOL 25
 - terminal (node)
 - electric currents 166
 - electrostatics 131
 - electrostatics, boundary elements 150
 - theory
 - constitutive relations 33–34
 - electric currents interface 224
 - electric currents, shell 229
 - electric fields 214
 - electrical circuit interface 361
 - electromagnetics 32
 - electrostatics interface 214
 - lumped ports 103
 - magnetic and electric fields 332, 341
 - magnetic field formulation 337
 - magnetic fields interface 330
 - magnetic fields, no currents 340
 - thin low permeability gap (node)
 - magnetic fields 279
 - magnetic fields, no currents 297
 - thin low permittivity gap (node) 129

- thin shells, conductive media 229
- time dependent study 70, 217, 225
- torque forces 49
- torques, calculating 74
- Touchstone and port sweeps 98
- transformations, Galilei 53
- transformer (node) 355
- transient study 70
- transition boundary condition (node) 278
- U** user defined coil 90
- user defined coil geometry (node) 260
- V** vacuum stress tensors
 - electromagnetics 50
 - moving bodies 54
- variables
 - coil domains 85
 - physical quantities 59
 - S-parameters 107
- varying thickness 211
- velocity (Lorentz term) (node) 245
- Vickers correlation coefficient 227
- Vickers size index 227
- voltage source (node) 348
- voltage-controlled current source (node) 351
- voltage-controlled voltage source (node) 350
- voltmeter (node) 346
- volume average, permeability 222
- volume average, permittivity 221
- volume averages, porous media 220
- W** wavelength 73
- websites, COMSOL 26
- Z** zero charge (node) 125
- zero charge, boundar elements (node) 151
- zero magnetic scalar potential (node) 295
- magnetic fields, no currents, boundary elements 304